

INTRODUCTION TO
JAVA[™]
PROGRAMMING

BRIEF VERSION



9TH EDITION



Y. Daniel Liang

ONLINE ACCESS

Thank you for purchasing a new copy of *Introduction to Java Programming, Brief Version, Ninth Edition*. Your textbook includes six months of prepaid access to the book's Companion Website. This prepaid subscription provides you with full access to the following student support areas:

- VideoNotes are step-by-step video tutorials specifically designed to enhance the programming concepts presented in this textbook.

**Use a coin to scratch off the coating and reveal your student access code.
Do not use a knife or other sharp object as it may damage the code.**

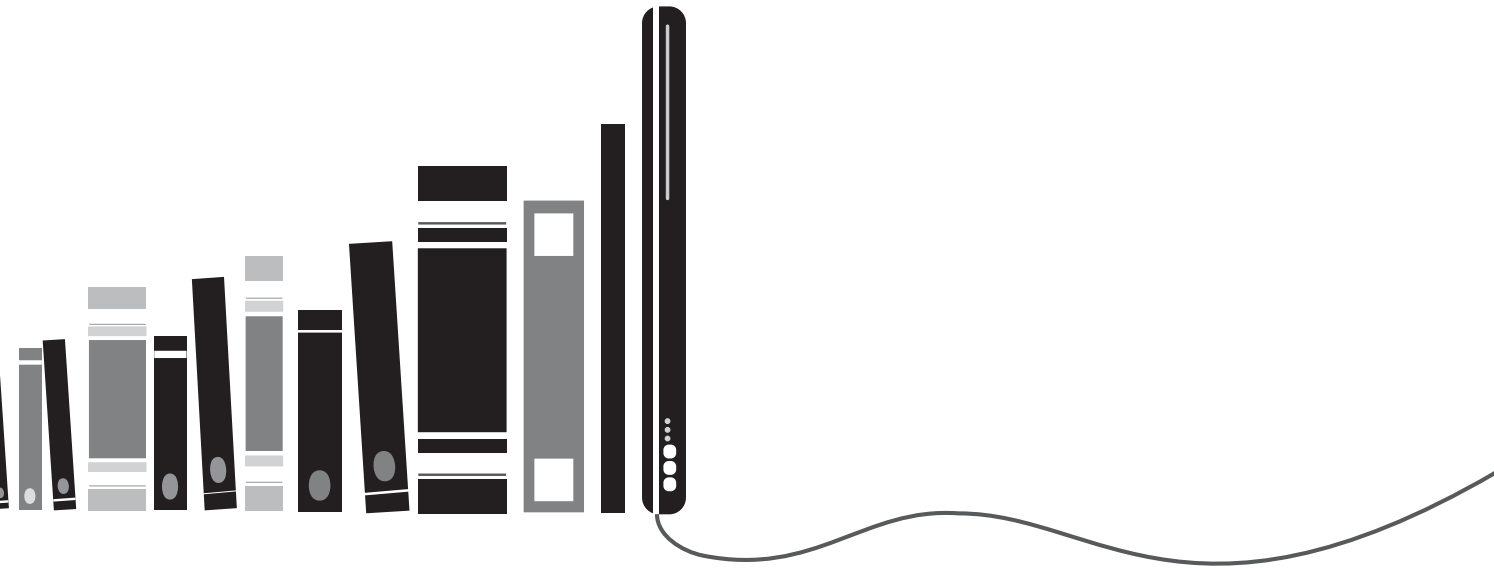
To access the *Introduction to Java Programming, Brief Version, Ninth Edition*, Companion Website for the first time, you will need to register online using a computer with an Internet connection and a web browser. The process takes just a couple of minutes and only needs to be completed once.

- 1.** Go to <http://www.pearsonhighered.com/liang/>
- 2.** Click on **Companion Website**.
- 3.** Click on the **Register** button.
- 4.** On the registration page, enter your student access code* found beneath the scratch-off panel. Do not type the dashes. You can use lower- or uppercase.
- 5.** Follow the on-screen instructions. If you need help at any time during the online registration process, simply click the **Need Help?** icon.
- 6.** Once your personal Login Name and Password are confirmed, you can begin using the *Introduction to Java Programming, Brief Version* Companion Website!

To log in after you have registered:

You only need to register for this Companion Website once. After that, you can log in any time at <http://www.pearsonhighered.com/liang/> by providing your Login Name and Password when prompted.

*Important: The access code can only be used once. This subscription is valid for six months upon activation and is not transferable. If this access code has already been revealed, it may no longer be valid. If this is the case, you can purchase a subscription by going to <http://www.pearsonhighered.com/liang/> and following the on-screen instructions.



get with the programming

Through the power of practice and immediate personalized feedback, MyProgrammingLab improves your performance.

MyProgrammingLab™

Learn more at www.myprogramminglab.com

This page intentionally left blank

INTRODUCTION TO
JAVATM
PROGRAMMING
BRIEF VERSION

Ninth Edition

Y. Daniel Liang

Armstrong Atlantic State University

PEARSON

Boston Columbus Indianapolis New York San Francisco Upper Saddle River
Amsterdam Cape Town Dubai London Madrid Milan Munich Paris Montreal Toronto
Delhi Mexico City Sao Paulo Sydney Hong Kong Seoul Singapore Taipei Tokyo

Editorial Director: Marcia Horton
Editor in Chief: Michael Hirsch
Executive Editor: Tracy Dunkelberger
Associate Editor: Carole Snyder
Director of Marketing: Patrice Jones
Marketing Manager: Yez Alayan
Marketing Coordinator: Kathryn Ferranti
Marketing Assistant: Emma Snider
Director of Production: Vince O'Brien
Managing Editor: Jeff Holcomb
Production Project Manager: Kayla Smith-Tarbox
Operations Supervisor: Alan Fischer
Manufacturing Buyer: Lisa McDowell

Art Director: Anthony Gemmellaro
Cover Designer: Anthony Gemmellaro
Manager, Visual Research: Karen Sanatar
Manager, Rights and Permissions: Mike Joyce
Text Permission Coordinator: Danielle Simon
and Jenn Kennett
Cover Illustration: Jason Consalvo
Lead Media Project Manager: Daniel Sandin
Project Management: Gillian Hall
Composition and Art: Laserwords
Printer/Binder: Edwards Brothers
Cover Printer: Lehigh-Phoenix Color/Hagerstown
Text Font: Times 10/12

Credits and acknowledgments borrowed from other sources and reproduced, with permission, in this textbook appear on the appropriate page within text and as follows: Table 3.2 and 10.1: Data from IRS. Figures 8.1, 8.12, 12.3, 12.5, 12.7, 12.9, 12.10, 12.12–12.21, 12.26–12.30, 13.1, 13.4, 13.9, 13.11, 13.15, 13.17, 13.19, 13.21, 13.23, 13.25–13.35, 14.10, 14.14, 15.9–15.11, 16.1, 16.2, 16.8, 16.11, 16.14, 16.17, 16.19–16.35, 17.1, 17.3, 17.6, 17.9, 17.12, 17.13, 17.15, 17.17–17.32, 18.6–18.8, 18.10, 18.15–18.35, 19.19, 19.20, 19.22, 20.1, 20.9, 20.12–20.14, 20.16–20.20: Screenshots © 2011 by Oracle Corporation. Reprinted with permission.

Microsoft® and Windows® are registered trademarks of the Microsoft Corporation in the U.S.A. and other countries. Screen shots and icons reprinted with permission from the Microsoft Corporation. This book is not sponsored or endorsed by or affiliated with the Microsoft Corporation.

Copyright © 2013, 2011, 2009, 2007, 2004 by Pearson Education, Inc., publishing as Prentice Hall. All rights reserved. Manufactured in the United States of America. This publication is protected by Copyright, and permission should be obtained from the publisher prior to any prohibited reproduction, storage in a retrieval system, or transmission in any form or by any means, electronic, mechanical, photocopying, recording, or likewise. To obtain permission(s) to use material from this work, please submit a written request to Pearson Education, Inc., Permissions Department, One Lake Street, Upper Saddle River, New Jersey 07458, or you may fax your request to 201-236-3290.

Many of the designations by manufacturers and sellers to distinguish their products are claimed as trademarks. Where those designations appear in this book, and the publisher was aware of a trademark claim, the designations have been printed in initial caps or all caps.

Library of Congress Cataloging-in-Publication Data available upon request.

Prentice Hall
is an imprint of



www.pearsonhighered.com

10 9 8 7 6 5 4 3 2 1

ISBN 13: 978-0-13-292373-6
ISBN 10: 0-13-292373-4

This book is dedicated to Professor Myers Foreman. Myers used the comprehensive version of this book in CS1, CS2, and CS3 at Lamar University and provided invaluable suggestions for improving the book. Sadly, Myers passed away after he completed the review of this edition.

To Samantha, Michael, and Michelle

This page intentionally left blank

PREFACE

Dear Reader,

Many of you have provided feedback on earlier editions of this book, and your comments and suggestions have greatly improved the book. This edition has been substantially enhanced in presentation, organization, examples, exercises, and supplements. We have: what is new?

- Reorganized sections and chapters to present the subjects in a more logical order
- Included many new interesting examples and exercises to stimulate interests
- Updated to Java 7
- Created animations for algorithms and data structures to visually demonstrate the concepts
- Redesigned the support Website to make it easier to navigate

This book teaches programming in a problem-driven way that focuses on problem solving rather than syntax. We make introductory programming interesting by using thought-provoking problems in a broad context. The central thread of early chapters is on problem solving. Appropriate syntax and library are introduced to enable readers to write programs for solving the problems. To support the teaching of programming in a problem-driven way, the book provides a wide variety of problems at various levels of difficulty to motivate students. To appeal to students in all majors, the problems cover many application areas, including math, science, business, financial, gaming, animation, and multimedia. problem-driven

The book focuses on fundamentals first by introducing basic programming concepts and techniques before designing custom classes. The fundamental concepts and techniques of loops, methods, and arrays are the foundation for programming. Building this strong foundation prepares students to learn object-oriented programming and advanced Java programming. fundamentals-first

This book is a *brief version* of Introduction to Java Programming, *Comprehensive Version*, 9E. This version is designed for an introductory programming course, commonly known as CS1. This version contains the first twenty chapters in the comprehensive version. The brief version covers fundamentals of programming, object-oriented programming, GUI programming, exception handling, I/O, and recursion. The comprehensive version has an additional thirty chapters that cover data structures and algorithms, threads, parallel programming, networking, internationalization, advanced GUI, database, and Web programming. brief version
comprehensive version

The best way to teach programming is *by example*, and the only way to learn programming is *by doing*. Basic concepts are explained by example, and a large number of exercises with various levels of difficulty are provided for students to practice. For our programming courses, we assign programming exercises after each lecture. examples and exercises

Our goal is to produce a text that teaches problem solving and programming in a broad context using a wide variety of interesting examples. If you have any comments on and suggestions for improving the book, please email me.

Sincerely,

Y. Daniel Liang
y.daniel.liang@gmail.com
www.cs.armstrong.edu/liang
www.pearsonhighered.com/liang

What's New in This Edition?

This edition substantially improves *Introduction to Java Programming*, Eighth Edition. The major improvements are as follows:

- complete revision ■ This edition is completely revised in every detail to enhance clarity, presentation, content, examples, and exercises.
- new problems ■ New examples and exercises are provided to motivate and stimulate student interest in programming.
- key point ■ Each section starts with a Key Point that highlights the important concepts covered in the section.
- check point ■ Check Points provide review questions to help students track their progress and evaluate their learning after a major concept or example is covered.
- test questions ■ Each chapter provides test questions online. They are grouped by sections for students to do self-test. The questions are graded online.
- VideoNotes ■ New VideoNotes provide short video tutorials designed to reinforce code.
- basic GUI and graphics early ■ The Java GUI API is an excellent example of how the object-oriented principle is applied. Students learn better with concrete and visual examples. So basic GUI/Graphics is moved before introducing abstract classes and interfaces. You can however still choose to cover abstract classes and interfaces before GUI or skip GUI.
- numeric classes covered early ■ The numeric wrapper classes, **BigInteger**, and **BigDecimal** are now introduced in Chapter 10 to enable students to write code using these classes early.
- exception handling earlier ■ Exception handling is covered before abstract classes and interfaces so that students can build robust programs early. The instructor can still choose to cover exception handling later. Text I/O is now combined with exception handling to form a new chapter.
- simple generics early ■ Simple use of generics is introduced along with **ArrayList** in Chapter 11 and with **Comparable** in Chapter 15 while the complex detail on generics is introduced in the comprehensive version of the book.

Please visit www.cs.armstrong.edu/liang/intro9e/newfeatures.html for a complete list of new features as well as correlations to the previous edition.

Pedagogical Features

The book uses the following elements to help students get the most from the material:

- The **Objectives** at the beginning of each chapter list what students should learn from the chapter. This will help them determine whether they have met the objectives after completing the chapter.
- The **Introduction** opens the discussion with representative problems to give the reader an overview of what to expect from the chapter.
- **Key Points** highlight the important concepts covered in each section.
- **Check Points** provide review questions to help students track their progress as they read through the chapter and evaluate their learning.
- **Problems and Case Studies**, carefully chosen and presented in an easy-to-follow style, teach problem solving and programming concepts. The book uses many small, simple, and stimulating examples to demonstrate important ideas.

- The **Chapter Summary** reviews the important subjects that students should understand and remember. It helps them reinforce the key concepts they have learned in the chapter.
- **Test Questions** are accessible online, grouped by sections, for students to do self-test on programming concepts and techniques.
- **Programming Exercises** are grouped by sections to provide students with opportunities to apply the new skills they have learned on their own. The level of difficulty is rated as easy (no asterisk), moderate (*), hard (**), or challenging (***). The trick of learning programming is practice, practice, and practice. To that end, the book provides a great many exercises.
- **Notes, Tips, Cautions, and Design Guides** are inserted throughout the text to offer valuable advice and insight on important aspects of program development.



Note

Provides additional information on the subject and reinforces important concepts.



Tip

Teaches good programming style and practice.



Caution

Helps students steer away from the pitfalls of programming errors.

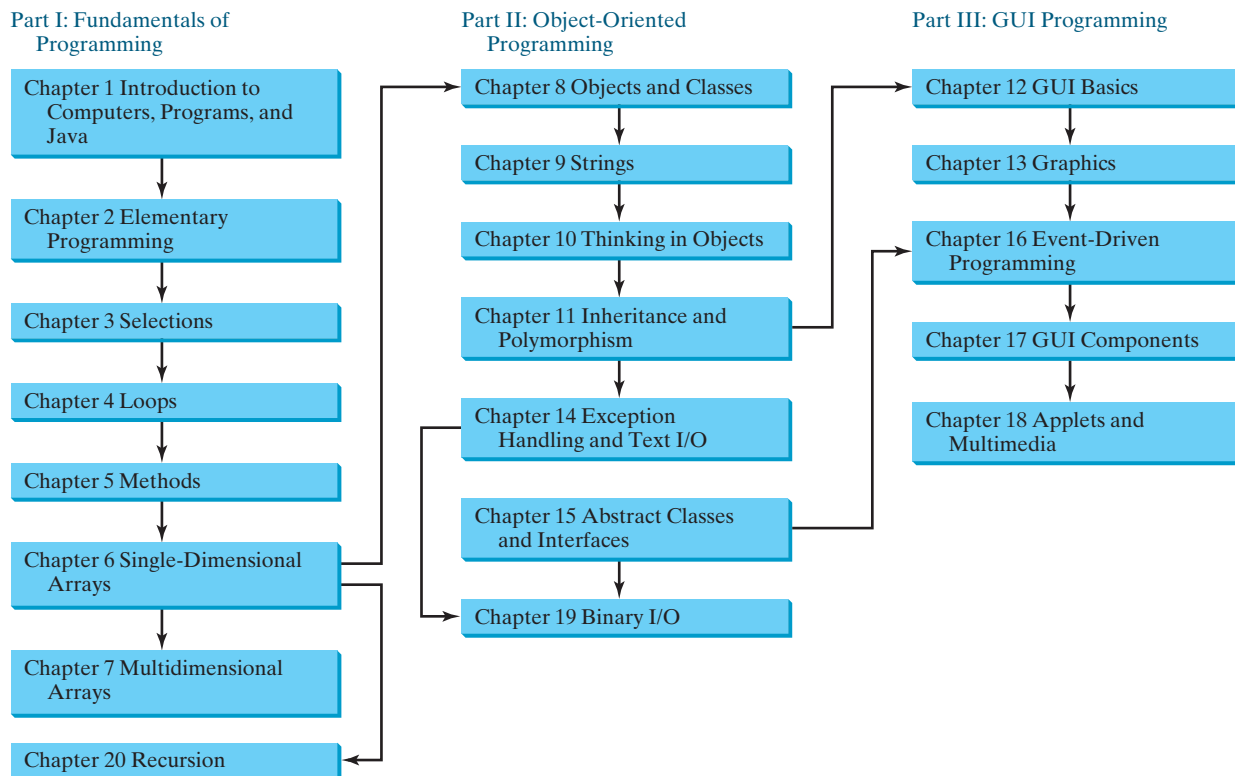


Design Guide

Provides guidelines for designing programs.

Flexible Chapter Orderings

The book is designed to provide flexible chapter orderings to enable GUI, exception handling, and recursion to be covered earlier or later. The diagram shows the chapter dependencies.



Organization of the Book

The chapters in the brief version can be grouped into three parts that, taken together, form a solid introduction to Java programming. Because knowledge is cumulative, the early chapters provide the conceptual basis for understanding programming and guide students through simple examples and exercises; subsequent chapters progressively present Java programming in detail, culminating with the development of comprehensive Java applications. The appendices contain a mixed bag of topics, including an introduction to number systems and bitwise operations.

Part I: Fundamentals of Programming (Chapters 1–7, 20)

The first part of the book is a stepping stone, preparing you to embark on the journey of learning Java. You will begin to learn about Java (Chapter 1) and fundamental programming techniques with primitive data types, variables, constants, assignments, expressions, and operators (Chapter 2), control statements (Chapters 3–4), methods (Chapter 5), and arrays (Chapters 6–7). After Chapter 6, you can jump to Chapter 20 to learn how to write recursive methods for solving inherently recursive problems.

Part II: Object-Oriented Programming (Chapters 8–11, 14–15, and 19)

This part introduces object-oriented programming. Java is an object-oriented programming language that uses abstraction, encapsulation, inheritance, and polymorphism to provide great flexibility, modularity, and reusability in developing software. You will learn programming with objects and classes (Chapters 8–10), class inheritance (Chapter 11), polymorphism (Chapter 11), exception handling and text I/O (Chapter 14), abstract classes (Chapter 15), and interfaces (Chapter 15). Processing strings is introduced in Chapter 9, and binary I/O is discussed in Chapter 19.

Part III: GUI Programming (Chapters 12–13, 16–18)

This part introduces elementary Java GUI programming in Chapters 12–13 and 16–18. Major topics include GUI basics (Chapter 12), drawing shapes (Chapter 13), event-driven programming (Chapter 16), using GUI components (Chapter 17), and writing applets (Chapter 18). You will learn the architecture of Java GUI programming and use the GUI components to develop applications and applets from these elementary GUI chapters.

Appendixes

This part of the book covers a mixed bag of topics. Appendix A lists Java keywords. Appendix B gives tables of ASCII characters and their associated codes in decimal and in hex. Appendix C shows the operator precedence. Appendix D summarizes Java modifiers and their usage. Appendix E discusses special floating-point values. Appendix F introduces number systems and conversions among binary, decimal, and hex numbers. Finally, Appendix G introduces bitwise operations.

Java Development Tools

You can use a text editor, such as the Windows Notepad or WordPad, to create Java programs and to compile and run the programs from the command window. You can also use a Java development tool, such as TextPad, NetBeans, or Eclipse. These tools support an integrated development environment (IDE) for developing Java programs quickly. Editing, compiling, building, executing, and debugging programs are integrated in one graphical user interface. Using these tools effectively can greatly increase your programming productivity. TextPad is a primitive IDE tool. NetBeans and Eclipse are more sophisticated, but they are easy to use if you follow the tutorials. Tutorials on TextPad, NetBeans, and Eclipse can be found in the supplements on the Companion Website www.cs.armstrong.edu/liang/intro9e.

Online Practice and Assessment with MyProgrammingLab

MyProgrammingLab™

MyProgrammingLab helps students fully grasp the logic, semantics, and syntax of programming. Through practice exercises and immediate, personalized feedback, MyProgrammingLab improves the programming competence of beginning students who often struggle with the basic concepts and paradigms of popular high-level programming languages.

A self-study and homework tool, a MyProgrammingLab course consists of hundreds of small practice problems organized around the structure of this textbook. For students, the system automatically detects errors in the logic and syntax of their code submissions and offers targeted hints that enable students to figure out what went wrong—and why. For instructors, a comprehensive gradebook tracks correct and incorrect answers and stores the code inputted by students for review.

MyProgrammingLab is offered to users of this book in partnership with Turing's Craft, the makers of the CodeLab interactive programming exercise system. For a full demonstration, to see feedback from instructors and students, or to get started using MyProgrammingLab in your course, visit www.myprogramminglab.com.

VideoNotes

We are excited about the new VideoNotes feature that is found in this new edition. These videos provide additional help by presenting examples of key topics and showing how to solve problems completely, from design through coding. VideoNotes are free to first time users and can be accessed by redeeming the access code in the front of this book at www.pearsonhighered.com/liang.



VideoNote

LiveLab

This book is accompanied by a complementary Web-based course assessment and management system for instructors. The system has four main components:

- The **Automatic Grading System** can automatically grade programs.
- The **Quiz Creation/Submission/Grading System** enables instructors to create and modify quizzes that students can take and be graded upon automatically.
- The **Peer Evaluation System** enables peer evaluations.
- **Tracking grades, attendance, etc.**, lets students track their grades, and enables instructors to view the grades of all students and to track students' attendance.

The main features of the Automatic Grading System include:

- Students can run and submit exercises. (The system checks whether their program runs correctly—students can continue to run and resubmit the program before the due date.)
- Instructors can review submissions, run programs with instructor test cases, correct them, provide feedback to students, and check plagiarism.
- Instructors can create/modify their own exercises, create public and secret test cases, assign exercises, and set due dates for the whole class or for individuals.
- Instructors can assign all the exercises in the text to students. Additionally, LiveLab provides extra exercises that are not printed in the text.
- Instructors can sort and filter all exercises and check grades (by time frame, student, and/or exercise).

- Instructors can delete students from the system.
- Students and instructors can track grades on exercises.

The main features of the Quiz System are:

- Instructors can create/modify quizzes from the test bank or a text file or create completely new tests online.
- Instructors can assign the quizzes to students and set a due date and test time limit for the whole class or for individuals.
- Students and instructors can review submitted quizzes.
- Instructors can analyze quizzes and identify students' weaknesses.
- Students and instructors can track grades on quizzes.

The main features of the Peer Evaluation System include:

- Instructors can assign peer evaluation for programming exercises.
- Instructors can view peer evaluation reports.

Student Resource Website

The Student Resource Website (www.cs.armstrong.edu/liang/intro9e) contains the following resources:

- Access to VideoNotes (www.pearsonhighered.com/liang).
- Answers to check point questions
- Solutions to even-numbered programming exercises
- Source code for the examples in the book
- Interactive self-testing (organized by sections for each chapter)
- Data structures and algorithm animations
- Errata

Instructor Resource Website

The Instructor Resource Website, accessible from www.cs.armstrong.edu/liang/intro9e, contains the following resources:

- Microsoft PowerPoint slides with interactive buttons to view full-color, syntax-highlighted source code and to run programs without leaving the slides.
- Solutions to all programming exercises. Students will have access to the solutions of even-numbered programming exercises.
- Web-based quiz generator. (Instructors can choose chapters to generate quizzes from a large database of more than two thousand questions.)
- Sample exams. Most exams have four parts:
 - Multiple-choice questions or short-answer questions
 - Correct programming errors

- Trace programs
- Write programs
- Projects. In general, each project gives a description and asks students to analyze, design, and implement the project.

Some readers have requested the materials from the Instructor Resource Website. Please understand that these are for instructors only. Such requests will not be answered.

Algorithm Animations

We have provided numerous animations for algorithms. These are valuable pedagogical tools to demonstrate how algorithms work. Algorithm animations can be accessed from the Companion Website.

Acknowledgments

I would like to thank Armstrong Atlantic State University for enabling me to teach what I write and for supporting me in writing what I teach. Teaching is the source of inspiration for continuing to improve the book. I am grateful to the instructors and students who have offered comments, suggestions, bug reports, and praise.

This book has been greatly enhanced thanks to outstanding reviews for this and previous editions. The reviewers are: Elizabeth Adams (James Madison University), Syed Ahmed (North Georgia College and State University), Omar Aldawud (Illinois Institute of Technology), Yang Ang (University of Wollongong, Australia), Kevin Bierre (Rochester Institute of Technology), David Champion (DeVry Institute), James Chegwiddden (Tarrant County College), Anup Dargar (University of North Dakota), Charles Dierbach (Towson University), Frank Ducrest (University of Louisiana at Lafayette), Erica Eddy (University of Wisconsin at Parkside), Deena Engel (New York University), Henry A. Etlinger (Rochester Institute of Technology), James Ten Eyck (Marist College), Myers Foreman (Lamar University), Olac Fuentes (University of Texas at El Paso), Edward F. Gehringer (North Carolina State University), Harold Grossman (Clemson University), Barbara Guillot (Louisiana State University), Stuart Hansen (University of Wisconsin, Parkside), Dan Harvey (Southern Oregon University), Ron Hofman (Red River College, Canada), Stephen Hughes (Roanoke College), Vladan Jovanovic (Georgia Southern University), Edwin Kay (Lehigh University), Larry King (University of Texas at Dallas), Nana Kofi (Langara College, Canada), George Koutsogiannakis (Illinois Institute of Technology), Roger Kraft (Purdue University at Calumet), Norman Krumpke (Miami University), Hong Lin (DeVry Institute), Dan Lipsa (Armstrong Atlantic State University), James Madison (Rensselaer Polytechnic Institute), Frank Malinowski (Darton College), Tim Margush (University of Akron), Debbie Masada (Sun Microsystems), Blayne Mayfield (Oklahoma State University), John McGrath (J.P. McGrath Consulting), Hugh McGuire (Grand Valley State), Shyamal Mitra (University of Texas at Austin), Michel Mitri (James Madison University), Kenrick Mock (University of Alaska Anchorage), Frank Murgolo (California State University, Long Beach), Jun Ni (University of Iowa), Benjamin Nystuen (University of Colorado at Colorado Springs), Maureen Opkins (CA State University, Long Beach), Gavin Osborne (University of Saskatchewan), Kevin Parker (Idaho State University), Dale Parson (Kutztown University), Mark Pendergast (Florida Gulf Coast University), Richard Povinelli (Marquette University), Roger Priebe (University of Texas at Austin), Mary Ann Pumphrey (De Anza Junior College), Pat Roth (Southern Polytechnic State University), Amr Sabry (Indiana University), Carolyn Schauble (Colorado State University), David Scuse (University of Manitoba), Ashraf Shirani (San Jose State University), Daniel Spiegel (Kutztown University), Joslyn A. Smith (Florida Atlantic University), Lixin Tao (Pace University), Ronald F. Taylor (Wright State University), Russ

Tront (Simon Fraser University), Deborah Trytten (University of Oklahoma), Kent Vidrine (George Washington University), and Bahram Zartoshty (California State University at Northridge).

It is a great pleasure, honor, and privilege to work with Pearson. I would like to thank Tracy Dunkelberger and her colleagues Marcia Horton, Michael Hirsch, Matt Goldstein, Carole Snyder, Tim Huddleston, Yez Alayan, Jeff Holcomb, Kayla Smith-Tarbox, Gillian Hall, Rebecca Greenberg, and their colleagues for organizing, producing, and promoting this project.

As always, I am indebted to my wife, Samantha, for her love, support, and encouragement.

BRIEF CONTENTS

1	Introduction to Computers, Programs, and Java	1	16	Event-Driven Programming	599
2	Elementary Programming	33	17	GUI Components	639
3	Selections	81	18	Applets and Multimedia	671
4	Loops	133	19	Binary I/O	709
5	Methods	177	20	Recursion	737
6	Single-Dimensional Arrays	223	APPENDIXES		
7	Multidimensional Arrays	263	A	Java Keywords	771
8	Objects and Classes	295	B	The ASCII Character Set	772
9	Strings	335	C	Operator Precedence Chart	774
10	Thinking in Objects	369	D	Java Modifiers	776
11	Inheritance and Polymorphism	407	E	Special Floating-Point Values	778
12	GUI Basics	445	F	Number Systems	779
13	Graphics	479	G	Bitwise Operations	783
14	Exception Handling and Text I/O	517	INDEX		
15	Abstract Classes and Interfaces	559			785

CONTENTS

Chapter 1	Introduction to Computers, Programs, and Java	1
1.1	Introduction	2
1.2	What Is a Computer?	2
1.3	Programming Languages	9
1.4	Operating Systems	12
1.5	Java, the World Wide Web, and Beyond	13
1.6	The Java Language Specification, API, JDK, and IDE	16
1.7	A Simple Java Program	16
1.8	Creating, Compiling, and Executing a Java Program	19
1.9	Displaying Text in a Message Dialog Box	22
1.10	Programming Style and Documentation	24
1.11	Programming Errors	26
Chapter 2	Elementary Programming	33
2.1	Introduction	34
2.2	Writing a Simple Program	34
2.3	Reading Input from the Console	37
2.4	Identifiers	40
2.5	Variables	40
2.6	Assignment Statements and Assignment Expressions	42
2.7	Named Constants	43
2.8	Naming Conventions	44
2.9	Numeric Data Types and Operations	44
2.10	Numeric Literals	48
2.11	Evaluating Expressions and Operator Precedence	50
2.12	Case Study: Displaying the Current Time	51
2.13	Augmented Assignment Operators	53
2.14	Increment and Decrement Operators	54
2.15	Numeric Type Conversions	56
2.16	Software Development Process	58
2.17	Character Data Type and Operations	62
2.18	The String Type	68
2.19	Getting Input from Input Dialogs	70

Chapter 3	Selections	81
3.1	Introduction	82
3.2	boolean Data Type	82
3.3	if Statements	84
3.4	Case Study: Guessing Birthdays	86
3.5	Two-Way if-else Statements	89
3.6	Nested if and Multi-Way if-else Statements	91
3.7	Common Errors in Selection Statements	93
3.8	Generating Random Numbers	96
3.9	Case Study: Computing Body Mass Index	97
3.10	Case Study: Computing Taxes	99
3.11	Logical Operators	101
3.12	Case Study: Determining Leap Year	105
3.13	Case Study: Lottery	106
3.14	switch Statements	108
3.15	Conditional Expressions	111
3.16	Formatting Console Output	112
3.17	Operator Precedence and Associativity	115
3.18	Confirmation Dialogs	117
3.19	Debugging	119
Chapter 4	Loops	133
4.1	Introduction	134
4.2	The while Loop	134
4.3	The do-while Loop	144
4.4	The for Loop	146
4.5	Which Loop to Use?	150
4.6	Nested Loops	152
4.7	Minimizing Numeric Errors	154
4.8	Case Studies	155
4.9	Keywords <i>break</i> and <i>continue</i>	159
4.10	Case Study: Displaying Prime Numbers	162
4.11	Controlling a Loop with a Confirmation Dialog	164
Chapter 5	Methods	177
5.1	Introduction	178
5.2	Defining a Method	178
5.3	Calling a Method	180
5.4	void Method Example	183
5.5	Passing Parameters by Values	186

5.6	Modularizing Code	189
5.7	Case Study: Converting Decimals to Hexadecimals	191
5.8	Overloading Methods	193
5.9	The Scope of Variables	196
5.10	The Math Class	197
5.11	Case Study: Generating Random Characters	201
5.12	Method Abstraction and Stepwise Refinement	203
Chapter 6	Single-Dimensional Arrays	223
6.1	Introduction	224
6.2	Array Basics	224
6.3	Case Study: Lotto Numbers	231
6.4	Case Study: Deck of Cards	234
6.5	Copying Arrays	236
6.6	Passing Arrays to Methods	237
6.7	Returning an Array from a Method	240
6.8	Case Study: Counting the Occurrences of Each Letter	241
6.9	Variable-Length Argument Lists	244
6.10	Searching Arrays	245
6.11	Sorting Arrays	248
6.12	The Arrays Class	252
Chapter 7	Multidimensional Arrays	263
7.1	Introduction	264
7.2	Two-Dimensional Array Basics	264
7.3	Processing Two-Dimensional Arrays	267
7.4	Passing Two-Dimensional Arrays to Methods	269
7.5	Case Study: Grading a Multiple-Choice Test	270
7.6	Case Study: Finding the Closest Pair	272
7.7	Case Study: Sudoku	274
7.8	Multidimensional Arrays	277
Chapter 8	Objects and Classes	295
8.1	Introduction	296
8.2	Defining Classes for Objects	296
8.3	Example: Defining Classes and Creating Objects	298
8.4	Constructing Objects Using Constructors	303
8.5	Accessing Objects via Reference Variables	304
8.6	Using Classes from the Java Library	308
8.7	Static Variables, Constants, and Methods	312
8.8	Visibility Modifiers	317

8.9	Data Field Encapsulation	319
8.10	Passing Objects to Methods	322
8.11	Array of Objects	326
Chapter 9	Strings	335
9.1	Introduction	336
9.2	The String Class	336
9.3	Case Study: Checking Palindromes	347
9.4	Case Study: Converting Hexadecimals to Decimals	348
9.5	The Character Class	350
9.6	The <code>StringBuilder</code> and <code>StringBuffer</code> Classes	353
9.7	Command-Line Arguments	358
Chapter 10	Thinking in Objects	369
10.1	Introduction	370
10.2	Immutable Objects and Classes	370
10.3	The Scope of Variables	371
10.4	The <code>this</code> Reference	373
10.5	Class Abstraction and Encapsulation	375
10.6	Object-Oriented Thinking	379
10.7	Object Composition	382
10.8	Case Study: Designing the Course Class	384
10.9	Case Study: Designing a Class for Stacks	386
10.10	Case Study: Designing the <code>GuessDate</code> Class	388
10.11	Class Design Guidelines	391
10.12	Processing Primitive Data Type Values as Objects	393
10.13	Automatic Conversion between Primitive Types and Wrapper Class Types	396
10.14	The <code>BigInteger</code> and <code>BigDecimal</code> Classes	397
Chapter 11	Inheritance and Polymorphism	407
11.1	Introduction	408
11.2	Superclasses and Subclasses	408
11.3	Using the <code>super</code> Keyword	414
11.4	Overriding Methods	418
11.5	Overriding vs. Overloading	418
11.6	The <code>Object</code> Class and Its <code>toString()</code> Methods	420
11.7	Polymorphism	421
11.8	Dynamic Binding	422
11.9	Casting Objects and the <code>instanceof</code> Operator	425
11.10	The <code>Object</code> 's <code>equals</code> Method	429

11.11	The ArrayList Class	430
11.12	Case Study: A Custom Stack Class	436
11.13	The protected Data and Methods	437
11.14	Preventing Extending and Overriding	439
Chapter 12	GUI Basics	445
12.1	Introduction	446
12.2	Swing vs. AWT	446
12.3	The Java GUI API	446
12.4	Frames	449
12.5	Layout Managers	451
12.6	Using Panels as Subcontainers	458
12.7	The Color Class	460
12.8	The Font Class	461
12.9	Common Features of Swing GUI Components	462
12.10	Image Icons	465
12.11	JButton	467
12.12	JCheckBox	471
12.13	JRadioButton	472
12.14	Labels	473
12.15	Text Fields	474
Chapter 13	Graphics	479
13.1	Introduction	480
13.2	The Graphics Class	480
13.3	Drawing Strings, Lines, Rectangles, and Ovals	483
13.4	Case Study: The FigurePanel Class	485
13.5	Drawing Arcs	488
13.6	Drawing Polygons and Polylines	490
13.7	Centering a String Using the FontMetrics Class	493
13.8	Case Study: The MessagePanel Class	495
13.9	Case Study: The StillClock Class	500
13.10	Displaying Images	504
13.11	Case Study: The ImageViewer Class	506
Chapter 14	Exception Handling and Text I/O	517
14.1	Introduction	518
14.2	Exception-Handling Overview	518
14.3	Exception Types	523
14.4	More on Exception Handling	526
14.5	The finally Clause	534

14.6	When to Use Exceptions	535
14.7	Rethrowing Exceptions	536
14.8	Chained Exceptions	537
14.9	Defining Custom Exception Classes	538
14.10	The File Class	541
14.11	File Input and Output	544
14.12	File Dialogs	549
14.13	Reading Data from the Web	551
Chapter 15	Abstract Classes and Interfaces	559
15.1	Introduction	560
15.2	Abstract Classes	560
15.3	Case Study: the Abstract Number Class	565
15.4	Case Study: Calendar and GregorianCalendar	567
15.5	Interfaces	570
15.6	The Comparable Interface	573
15.7	The Cloneable Interface	577
15.8	Interfaces vs. Abstract Classes	581
15.9	Case Study: The Rational Class	584
Chapter 16	Event-Driven Programming	599
16.1	Introduction	600
16.2	Events and Event Sources	602
16.3	Listeners, Registrations, and Handling Events	603
16.4	Inner Classes	608
16.5	Anonymous Class Listeners	609
16.6	Alternative Ways of Defining Listener Classes	612
16.7	Case Study: Loan Calculator	615
16.8	Mouse Events	617
16.9	Listener Interface Adapters	620
16.10	Key Events	621
16.11	Animation Using the Timer Class	625
Chapter 17	GUI Components	639
17.1	Introduction	640
17.2	Events for JCheckBox, JRadioButton and JTextField	640
17.3	Text Areas	644
17.4	Combo Boxes	647
17.5	Lists	650
17.6	Scroll Bars	654

17.7	Sliders	657
17.8	Creating Multiple Windows	660
Chapter 18	Applets and Multimedia	671
18.1	Introduction	672
18.2	Developing Applets	672
18.3	The HTML File and the <applet>Tag	673
18.4	Applet Security Restrictions	675
18.5	Enabling Applets to Run as Applications	676
18.6	Applet Life-Cycle Methods	677
18.7	Passing Strings to Applets	679
18.8	Case Study: Bouncing Ball	683
18.9	Case Study: Developing a Tic-Tac-Toe Game	686
18.10	Locating Resources Using the URL Class	691
18.11	Playing Audio in Any Java Program	693
18.12	Case Study: National Flags and Anthems	695
Chapter 19	Binary I/O	709
19.1	Introduction	710
19.2	How Is Text I/O Handled in Java?	710
19.3	Text I/O vs. Binary I/O	711
19.4	Binary I/O Classes	712
19.5	Case Study: Copying Files	722
19.6	Object I/O	724
19.7	Random-Access Files	729
Chapter 20	Recursion	737
20.1	Introduction	738
20.2	Case Study: Computing Factorials	738
20.3	Case Study: Computing Fibonacci Numbers	741
20.4	Problem Solving Using Recursion	744
20.5	Recursive Helper Methods	746
20.6	Case Study: Finding the Directory Size	749
20.7	Case Study: Towers of Hanoi	750
20.8	Case Study: Fractals	754
20.9	Recursion vs. Iteration	757
20.10	Tail Recursion	758

APPENDIXES

Appendix A	Java Keywords	771
Appendix B	The ASCII Character Set	772
Appendix C	Operator Precedence Chart	774
Appendix D	Java Modifiers	776
Appendix E	Special Floating-Point Values	778
Appendix F	Number Systems	779
Appendix G	Bitwise Operations	783

INDEX	785
--------------	-----



VideoNote

VideoNotes

Locations of **VideoNotes**

<http://www.pearsonhighered.com/liang>

Chapter 1	Introduction to Computers, Programs, and Java	
	Your first Java program	17
	Eclipse brief tutorial	19
	NetBeans brief tutorial	19
	Compile and run a Java program	21
Chapter 2	Elementary Programming	
	Obtain input	37
	Use operators / and %	51
	Software development process	58
	Compute loan payments	59
	Compute BMI	77
Chapter 3	Selections	
	Program addition quiz	83
	Program subtraction quiz	96
	Use multi-way <code>if-else</code> statements	99
	Sort three integers	123
	Check point location	125
Chapter 4	Loops	
	Guess a number	137
	Multiple subtraction quiz	139
	Minimize numeric errors	154
	Display loan schedule	170
	Sum a series	170
Chapter 5	Methods	
	Define/invoke <code>max</code> method	180
	Use <code>void</code> method	183
	Modularize code	189
	Stepwise refinement	203
	Reverse an integer	212
	Estimate π	215
Chapter 6	Single-Dimensional Arrays	
	Random shuffling	228
	Lotto numbers	231
	Selection sort	249
	Coupon collector's problem	260
	Consecutive four	261
Chapter 7	Multidimensional Arrays	
	Find the row with the largest sum	268
	Grade multiple-choice test	270
	Sudoku	274
	Multiply two matrices	282
	Even number of 1s	289
Chapter 8	Objects and Classes	
	Define classes and objects	296
	Use classes	311
	Static vs. instance	312
	Data field encapsulation	319
	The <code>Fan</code> class	331

Chapter 9	Strings	
	Check palindrome	347
	Command-line argument	359
	Number conversion	364
	Check ISBN-10	367
Chapter 10	Thinking in Objects	
	Immutable objects and <code>this</code> keyword	370
	The <code>Loan</code> class	376
	The <code>BMI</code> class	380
	The <code>StackOfIntegers</code> class	386
	Process large numbers	397
	The <code>MyPoint</code> class	400
Chapter 11	Inheritance and Polymorphism	
	Geometric class hierarchy	408
	Polymorphism and dynamic binding demo	423
	The <code>ArrayList</code> class	430
	The <code>MyStack</code> class	436
	New <code>Account</code> class	443
Chapter 12	GUI Basics	
	Use <code>FlowLayout</code>	452
	Use panels as subcontainers	458
	Use Swing common properties	462
	Display a checkerboard	477
	Display a random matrix	478
Chapter 13	Graphics	
	The <code>FigurePanel</code> class	485
	The <code>MessagePanel</code> class	495
	The <code>StillClock</code> class	500
	Plot a function	511
	Plot a bar chart	512
Chapter 14	Exception Handling and Text I/O	
	Exception-handling advantages	518
	Create custom exception classes	538
	Write and read data	544
	<code>HexFormatException</code>	555
Chapter 15	Abstract Classes and Interfaces	
	Abstract <code>GeometricObject</code> class	560
	<code>Calendar</code> and <code>GregorianCalendar</code> classes	567
	The concept of interface	570
	Redesign the <code>Rectangle</code> class	593
Chapter 16	Event-Driven Programming	
	Listener and its registration	607
	Anonymous listener	610
	Move message using the mouse	618
	Animate a clock	628
	Animate a rising flag	632
	Check mouse point location	632
Chapter 17	GUI Components	
	Use text areas	668
Chapter 18	Applets and Multimedia	
	First applet	672
	Run applets standalone	676

	TicTacToe	686
	Audio and image	695
	Control a group of clocks	701
Chapter 19	Binary I/O	
	Copy file	722
	Object I/O	724
	Split a large file	734
Chapter 20	Recursion	
	Binary search	748
	Directory size	749
	Fractal (Sierpinski triangle)	754
	Search a string in a directory	764

INTRODUCTION TO COMPUTERS, PROGRAMS, AND JAVA

Objectives

- To understand computer basics, programs, and operating systems (§§1.2–1.4).
- To describe the relationship between Java and the World Wide Web (§1.5).
- To understand the meaning of Java language specification, API, JDK, and IDE (§1.6).
- To write a simple Java program (§1.7).
- To display output on the console (§1.7).
- To explain the basic syntax of a Java program (§1.7).
- To create, compile, and run Java programs (§1.8).
- To display output using the **JOptionPane** message dialog boxes (§1.9).
- To become familiar with Java programming style and documentation (§1.10).
- To explain the differences between syntax errors, runtime errors, and logic errors (§1.11).



1.1 Introduction



The central theme of this book is to learn how to solve problems by writing a program.

what is programming?
programming
program

This book is about programming. So, what is programming? The term *programming* means to create (or develop) software, which is also called a *program*. In basic terms, software contains the instructions that tell a computer—or a computerized device—what to do.

Software is all around you, even in devices that you might not think would need it. Of course, you expect to find and use software on a personal computer, but software also plays a role in running airplanes, cars, cell phones, and even toasters. On a personal computer, you use word processors to write documents, Web browsers to explore the Internet, and e-mail programs to send messages. These programs are all examples of software. Software developers create software with the help of powerful tools called *programming languages*.

This book teaches you how to create programs by using the Java programming language. There are many programming languages, some of which are decades old. Each language was invented for a specific purpose—to build on the strengths of a previous language, for example, or to give the programmer a new and unique set of tools. Knowing that there are so many programming languages available, it would be natural for you to wonder which one is best. But, in truth, there is no “best” language. Each one has its own strengths and weaknesses. Experienced programmers know that one language might work well in some situations, whereas a different language may be more appropriate in other situations. For this reason, seasoned programmers try to master as many different programming languages as they can, giving them access to a vast arsenal of software-development tools.

If you learn to program using one language, you should find it easy to pick up other languages. The key is to learn how to solve problems using a programming approach. That is the main theme of this book.

You are about to begin an exciting journey: learning how to program. At the outset, it is helpful to review computer basics, programs, and operating systems. If you are already familiar with such terms as CPU, memory, disks, operating systems, and programming languages, you may skip the review in Sections 1.2–1.4.

1.2 What Is a Computer?



A computer is an electronic device that stores and processes data.

hardware
software

A computer includes both *hardware* and *software*. In general, hardware comprises the visible, physical elements of the computer, and software provides the invisible instructions that control the hardware and make it perform specific tasks. Knowing computer hardware isn't essential to learning a programming language, but it can help you better understand the effects that a program's instructions have on the computer and its components. This section introduces computer hardware components and their functions.

A computer consists of the following major hardware components (Figure 1.1):

- A central processing unit (CPU)
- Memory (main memory)
- Storage devices (such as disks and CDs)
- Input devices (such as the mouse and keyboard)
- Output devices (such as monitors and printers)
- Communication devices (such as modems and network interface cards)

bus

A computer's components are interconnected by a subsystem called a *bus*. You can think of a bus as a sort of system of roads running among the computer's components; data and

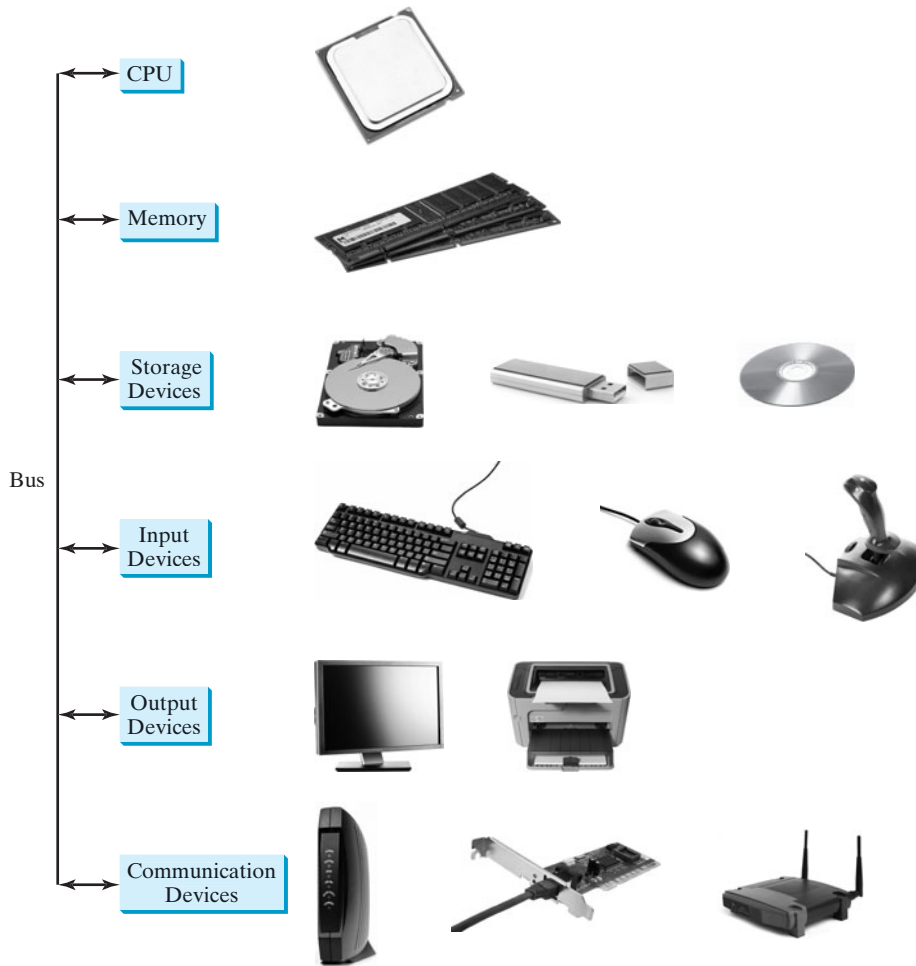


FIGURE 1.1 A computer consists of a CPU, memory, storage devices, input devices, output devices, and communication devices.

power travel along the bus from one part of the computer to another. In personal computers, the bus is built into the computer's *motherboard*, which is a circuit case that connects all of the parts of a computer together, as shown in Figure 1.2.

1.2.1 Central Processing Unit

The *central processing unit (CPU)* is the computer's brain. It retrieves instructions from memory and executes them. The CPU usually has two components: a *control unit* and an *arithmetic/logic unit*. The control unit controls and coordinates the actions of the other components. The arithmetic/logic unit performs numeric operations (addition, subtraction, multiplication, division) and logical operations (comparisons).

Today's CPUs are built on small silicon semiconductor chips that contain millions of tiny electric switches, called *transistors*, for processing information.

Every computer has an internal clock, which emits electronic pulses at a constant rate. These pulses are used to control and synchronize the pace of operations. A higher clock *speed* enables more instructions to be executed in a given period of time. The unit of measurement of clock speed is the *hertz (Hz)*, with 1 hertz equaling 1 pulse per second. In the 1990s computers measured clocked speed in *megahertz (MHz)*, but CPU speed has been improving continuously,

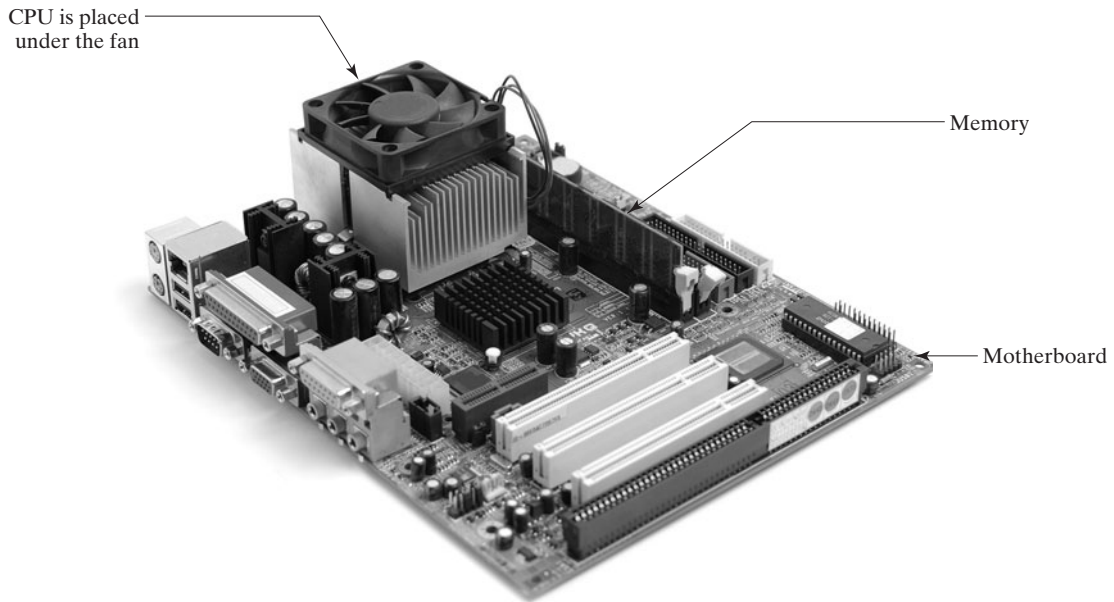


FIGURE 1.2 The motherboard connects all parts of a computer together.

gigahertz

and the clock speed of a computer is now usually stated in *gigahertz (GHz)*. Intel's newest processors run at about 3 GHz.

core

CPUs were originally developed with only one core. The *core* is the part of the processor that performs the reading and executing of instructions. In order to increase CPU processing power, chip manufacturers are now producing CPUs that contain multiple cores. A multicore CPU is a single component with two or more independent processors. Today's consumer computers typically have two, three, and even four separate cores. Soon, CPUs with dozens or even hundreds of cores will be affordable.

1.2.2 Bits and Bytes

Before we discuss memory, let's look at how information (data and programs) are stored in a computer.

bits

A computer is really nothing more than a series of switches. Each switch exists in two states: on or off. Storing information in a computer is simply a matter of setting a sequence of switches on or off. If the switch is on, its value is 1. If the switch is off, its value is 0. These 0s and 1s are interpreted as digits in the binary number system and are called *bits* (binary digits).

byte

The minimum storage unit in a computer is a *byte*. A byte is composed of eight bits. A small number such as **3** can be stored as a single byte. To store a number that cannot fit into a single byte, the computer uses several bytes.

encoding scheme

Data of various kinds, such as numbers and characters, are encoded as a series of bytes. As a programmer, you don't need to worry about the encoding and decoding of data, which the computer system performs automatically, based on the encoding scheme. An *encoding scheme* is a set of rules that govern how a computer translates characters, numbers, and symbols into data the computer can actually work with. Most schemes translate each character into a predetermined string of numbers. In the popular ASCII encoding scheme, for example, the character **C** is represented as **01000011** in one byte.

A computer's storage capacity is measured in bytes and multiples of the byte, as follows:

- A *kilobyte (KB)* is about 1,000 bytes. kilobyte (KB)
- A *megabyte (MB)* is about 1 million bytes. megabyte (MB)
- A *gigabyte (GB)* is about 1 billion bytes. gigabyte (GB)
- A *terabyte (TB)* is about 1 trillion bytes. terabyte (TB)

A typical one-page word document might take 20 KB. Therefore, 1 MB can store 50 pages of documents and 1 GB can store 50,000 pages of documents. A typical two-hour high-resolution movie might take 8 GB, so it would require 160 GB to store 20 movies.

1.2.3 Memory

A computer's *memory* consists of an ordered sequence of bytes for storing programs as well as data that the program is working with. You can think of memory as the computer's work area for executing a program. A program and its data must be moved into the computer's memory before they can be executed by the CPU. memory

Every byte in the memory has a *unique address*, as shown in Figure 1.3. The address is used to locate the byte for storing and retrieving the data. Since the bytes in the memory can be accessed in any order, the memory is also referred to as *random-access memory (RAM)*. unique address
RAM

Memory address	↓	Memory content	
.	.		
.	.		
.	.		
2000	01000011	Encoding for character 'C'	
2001	01110010	Encoding for character 'r'	
2002	01100101	Encoding for character 'e'	
2003	01110111	Encoding for character 'w'	
2004	00000011	Encoding for number 3	
.	.		

FIGURE 1.3 Memory stores data and program instructions in uniquely addressed memory locations. Each memory location can store one byte of data.

Today's personal computers usually have at least 1 gigabyte of RAM, but they more commonly have 2 to 4 GB installed. Generally speaking, the more RAM a computer has, the faster it can operate, but there are limits to this simple rule of thumb.

A memory byte is never empty, but its initial content may be meaningless to your program. The current content of a memory byte is lost whenever new information is placed in it.

Like the CPU, memory is built on silicon semiconductor chips that have millions of transistors embedded on their surface. Compared to CPU chips, memory chips are less complicated, slower, and less expensive.

1.2.4 Storage Devices

A computer's memory (RAM) is a volatile form of data storage: any information that has been stored in memory (that is, saved) is lost when the system's power is turned off. Programs and data are permanently stored on *storage devices* and are moved, when the computer actually uses them, to memory, which operates at much faster speeds than permanent storage devices can. storage devices

6 Chapter 1 Introduction to Computers, Programs, and Java

There are three main types of storage devices:

- Magnetic disk drives
- Optical disc drives (CD and DVD)
- USB flash drives

drive *Drives* are devices for operating a medium, such as disks and CDs. A storage medium physically stores data and program instructions. The drive reads data from the medium and writes data onto the medium.

Disks

hard disk A computer usually has at least one hard disk drive (Figure 1.4). *Hard disks* are used for permanently storing data and programs. Newer computers have hard disks that can store from 200 to 800 gigabytes of data. Hard disk drives are usually encased inside the computer, but removable hard disks are also available.



FIGURE 1.4 A hard disk is a device for permanently storing programs and data.

CDs and DVDs

CD-R *CD* stands for compact disc. There are two types of CD drives: CD-R and CD-RW. A *CD-R* is for read-only permanent storage; the user cannot modify its contents once they are recorded.

CD-RW A *CD-RW* can be used like a hard disk; that is, you can write data onto the disc, and then overwrite that data with new data. A single CD can hold up to 700 MB. Most new PCs are equipped with a CD-RW drive that can work with both CD-R and CD-RW discs.

DVD *DVD* stands for digital versatile disc or digital video disc. DVDs and CDs look alike, and you can use either to store data. A DVD can hold more information than a CD; a standard DVD's storage capacity is 4.7 GB. Like CDs, there are two types of DVDs: DVD-R (read-only) and DVD-RW (rewritable).

USB Flash Drives

Universal serial bus (USB) connectors allow the user to attach many kinds of peripheral devices to the computer. You can use a USB to connect a printer, digital camera, mouse, external hard disk drive, and other devices to the computer.

A *USB flash drive* is a device for storing and transporting data. A flash drive is small—about the size of a pack of gum, as shown in Figure 1.5. It acts like a portable hard drive that can be plugged into your computer’s USB port. USB flash drives are currently available with up to 256 GB storage capacity.

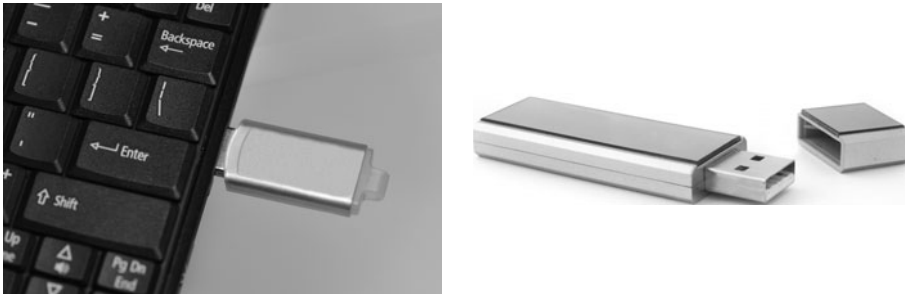


FIGURE 1.5 USB flash drives are very portable and can store a lot of data.

1.2.5 Input and Output Devices

Input and output devices let the user communicate with the computer. The most common input devices are *keyboards* and *mice*. The most common output devices are *monitors* and *printers*.

The Keyboard

A keyboard is a device for entering input. Figure 1.6 shows a typical keyboard. Compact keyboards are available without a numeric keypad.



FIGURE 1.6 A computer keyboard consists of the keys for sending input to a computer.

Function keys are located across the top of the keyboard and are prefaced with the letter *F*. function key
Their functions depend on the software currently being used.

8 Chapter 1 Introduction to Computers, Programs, and Java

modifier key

A *modifier key* is a special key (such as the *Shift*, *Alt*, and *Ctrl* keys) that modifies the normal action of another key when the two are pressed simultaneously.

numeric keypad

The *numeric keypad*, located on the right side of most keyboards, is a separate set of keys styled like a calculator to use for entering numbers quickly.

arrow keys

Arrow keys, located between the main keypad and the numeric keypad, are used to move the mouse pointer up, down, left, and right on the screen in many kinds of programs.

Insert key

Delete key

Page Up key

Page Down key

The *Insert*, *Delete*, *Page Up*, and *Page Down keys* are used in word processing and other programs for inserting text and objects, deleting text and objects, and moving up or down through a document one screen at a time.

The Mouse

A *mouse* is a pointing device. It is used to move a graphical pointer (usually in the shape of an arrow) called a *cursor* around the screen or to click on-screen objects (such as a button) to trigger them to perform an action.

The Monitor

The *monitor* displays information (text and graphics). The screen resolution and dot pitch determine the quality of the display.

screen resolution
pixels

The *screen resolution* specifies the number of pixels in horizontal and vertical dimensions of the display device. *Pixels* (short for “picture elements”) are tiny dots that form an image on the screen. A common resolution for a 17-inch screen, for example, is 1,024 pixels wide and 768 pixels high. The resolution can be set manually. The higher the resolution, the sharper and clearer the image is.

dot pitch

The *dot pitch* is the amount of space between pixels, measured in millimeters. The smaller the dot pitch, the sharper the display.

1.2.6 Communication Devices

modem

Computers can be networked through communication devices, such as a dial-up *modem* (modulator/demodulator), a DSL or cable modem, a wired network interface card, or a wireless adapter.

digital subscriber line (DSL)

- A dial-up modem uses a phone line and can transfer data at a speed up to 56,000 bps (bits per second).

cable modem

- A *digital subscriber line (DSL)* connection also uses a standard phone line, but it can transfer data 20 times faster than a standard dial-up modem.

network interface card (NIC)

local area network (LAN)

- A *cable modem* uses the cable TV line maintained by the cable company and is generally faster than DSL.

- A *network interface card (NIC)* is a device that connects a computer to a *local area network (LAN)*, as shown in Figure 1.7. LANs are commonly used in universities, businesses, and government agencies. A high-speed NIC called *1000BaseT* can transfer data at 1,000 million bits per second (mbps).

million bits per second
(mbps)

- Wireless networking is now extremely popular in homes, businesses, and schools. Every laptop computer sold today is equipped with a wireless adapter that enables the computer to connect to a local area network and the Internet.



Note

Answers to checkpoint questions are on the Companion Website.



1.1 What are hardware and software?

1.2 List five major hardware components of a computer.

1.3 What does the acronym “CPU” stand for?

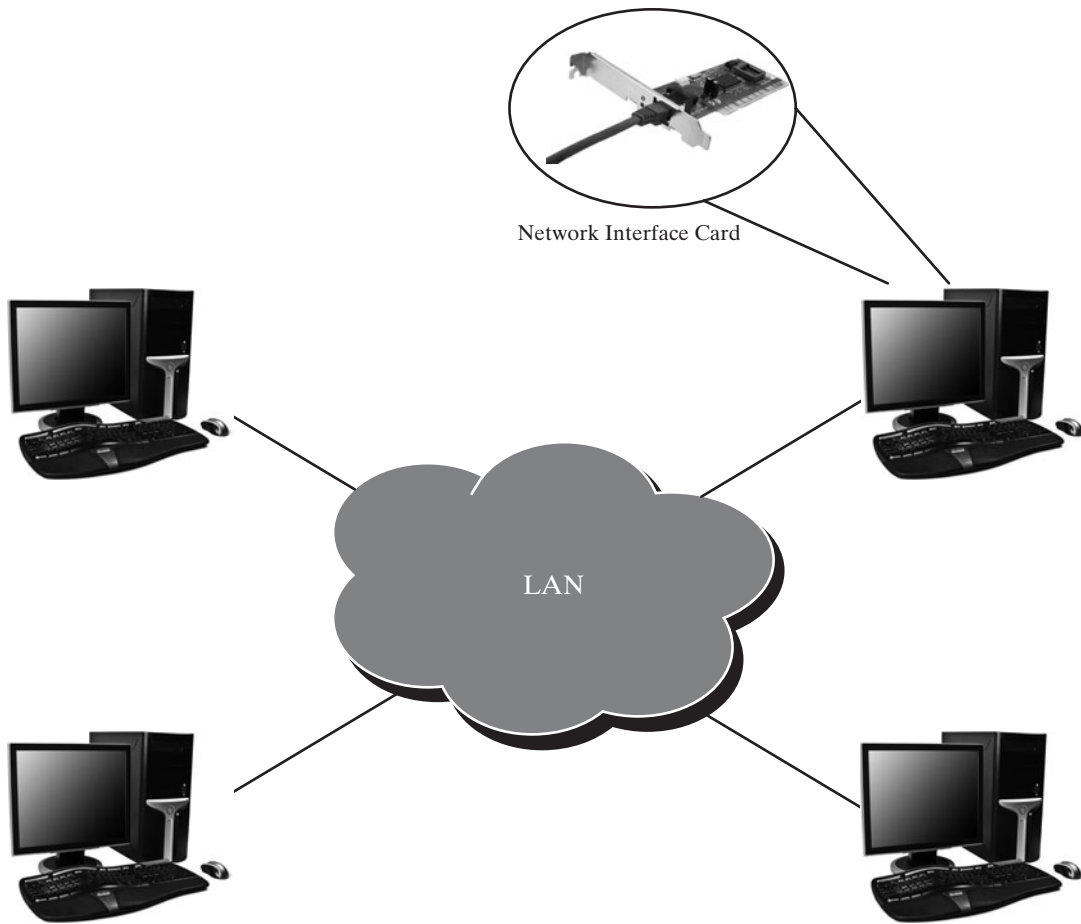


FIGURE 1.7 A local area network connects computers in close proximity to each other.

- 1.4 What unit is used to measure CPU speed?
- 1.5 What is a bit? What is a byte?
- 1.6 What is memory for? What does RAM stand for? Why is memory called RAM?
- 1.7 What unit is used to measure memory size?
- 1.8 What unit is used to measure disk size?
- 1.9 What is the primary difference between memory and a storage device?

1.3 Programming Languages

Computer programs, known as software, are instructions that tell a computer what to do.



Computers do not understand human languages, so programs must be written in a language a computer can use. There are hundreds of programming languages, and they were developed to make the programming process easier for people. However, all programs must be converted into a language the computer can understand.

1.3.1 Machine Language

A computer's native language, which differs among different types of computers, is its *machine language*—a set of built-in primitive instructions. These instructions are in the form of binary code, so if you want to give a computer an instruction in its native language, you

machine language

have to enter the instruction as binary code. For example, to add two numbers, you might have to write an instruction in binary code, like this:

```
1101101010011010
```

1.3.2 Assembly Language

assembly language

Programming in machine language is a tedious process. Moreover, programs written in machine language are very difficult to read and modify. For this reason, *assembly language* was created in the early days of computing as an alternative to machine languages. Assembly language uses a short descriptive word, known as a *mnemonic*, to represent each of the machine-language instructions. For example, the mnemonic **add** typically means to add numbers and **sub** means to subtract numbers. To add the numbers **2** and **3** and get the result, you might write an instruction in assembly code like this:

```
add 2, 3, result
```

assembler

Assembly languages were developed to make programming easier. However, because the computer cannot understand assembly language, another program—called an *assembler*—is used to translate assembly-language programs into machine code, as shown in Figure 1.8.

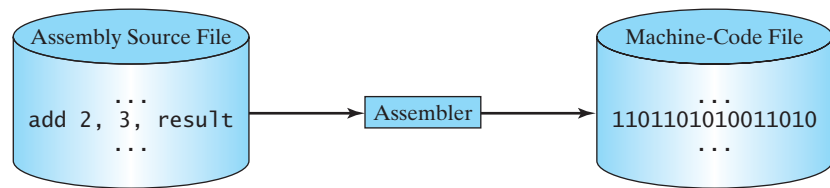


FIGURE 1.8 An assembler translates assembly-language instructions into machine code.

Writing code in assembly language is easier than in machine language. However, it is still tedious to write code in assembly language. An instruction in assembly language essentially corresponds to an instruction in machine code. Writing in assembly requires that you know how the CPU works. Assembly language is referred to as a *low-level language*, because assembly language is close in nature to machine language and is machine dependent.

low-level language

1.3.3 High-Level Language

high-level language

In the 1950s, a new generation of programming languages known as *high-level languages* emerged. They are platform-independent, which means that you can write a program in a high-level language and run it in different types of machines. High-level languages are English-like and easy to learn and use. The instructions in a high-level programming language are called *statements*. Here, for example, is a high-level language statement that computes the area of a circle with a radius of **5**:

statement

```
area = 5 * 5 * 3.1415
```

There are many high-level programming languages, and each was designed for a specific purpose. Table 1.1 lists some popular ones.

source program

source code

interpreter

compiler

A program written in a high-level language is called a *source program* or *source code*. Because a computer cannot understand a source program, a source program must be translated into machine code for execution. The translation can be done using another programming tool called an *interpreter* or a *compiler*.

- An interpreter reads one statement from the source code, translates it to the machine code or virtual machine code, and then executes it right away, as shown in Figure 1.9a.

TABLE 1.1 Popular High-Level Programming Languages

Language	Description
Ada	Named for Ada Lovelace, who worked on mechanical general-purpose computers. The Ada language was developed for the Department of Defense and is used mainly in defense projects.
BASIC	Beginner's All-purpose Symbolic Instruction Code. It was designed to be learned and used easily by beginners.
C	Developed at Bell Laboratories. C combines the power of an assembly language with the ease of use and portability of a high-level language.
C++	C++ is an object-oriented language, based on C.
C#	Pronounced "C Sharp." It is a hybrid of Java and C++ and was developed by Microsoft.
COBOL	COmmon Business Oriented Language. Used for business applications.
FORTRAN	FORmula TRANslation. Popular for scientific and mathematical applications.
Java	Developed by Sun Microsystems, now part of Oracle. It is widely used for developing platform-independent Internet applications.
Pascal	Named for Blaise Pascal, who pioneered calculating machines in the seventeenth century. It is a simple, structured, general-purpose language primarily for teaching programming.
Python	A simple general-purpose scripting language good for writing short programs.
Visual Basic	Visual Basic was developed by Microsoft and it enables the programmers to rapidly develop graphical user interfaces.

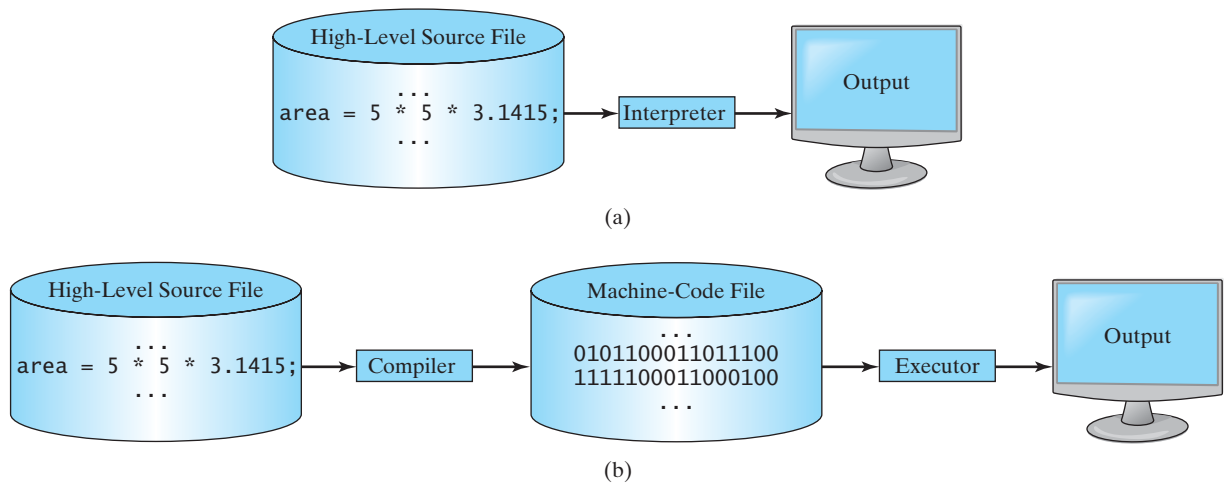


FIGURE 1.9 (a) An interpreter translates and executes a program one statement at a time. (b) A compiler translates the entire source program into a machine-language file for execution.

Note that a statement from the source code may be translated into several machine instructions.

- A compiler translates the entire source code into a machine-code file, and the machine-code file is then executed, as shown in Figure 1.9b.

1.10 What language does the CPU understand?

1.11 What is an assembly language?



MyProgrammingLab™

- I.12** What is an assembler?
- I.13** What is a high-level programming language?
- I.14** What is a source program?
- I.15** What is an interpreter?
- I.16** What is a compiler?
- I.17** What is the difference between an interpreted language and a compiled language?

1.4 Operating Systems



The operating system (OS) is the most important program that runs on a computer. The OS manages and controls a computer's activities.

operating system (OS)

The popular *operating systems* for general-purpose computers are Microsoft Windows, Mac OS, and Linux. Application programs, such as a Web browser or a word processor, cannot run unless an operating system is installed and running on the computer. Figure 1.10 shows the interrelationship of hardware, operating system, application software, and the user.

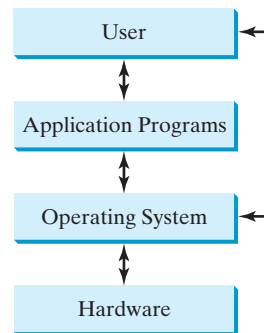


FIGURE 1.10 Users and applications access the computer's hardware via the operating system.

The major tasks of an operating system are:

- Controlling and monitoring system activities
- Allocating and assigning system resources
- Scheduling operations

1.4.1 Controlling and Monitoring System Activities

Operating systems perform basic tasks, such as recognizing input from the keyboard, sending output to the monitor, keeping track of files and folders on storage devices, and controlling peripheral devices, such as disk drives and printers. An operating system must also ensure that different programs and users working at the same time do not interfere with each other. In addition, the OS is responsible for security, ensuring that unauthorized users and programs do not access the system.

1.4.2 Allocating and Assigning System Resources

The operating system is responsible for determining what computer resources a program needs (such as CPU time, memory space, disks, input and output devices) and for allocating and assigning them to run the program.

1.4.3 Scheduling Operations

The OS is responsible for scheduling programs' activities to make efficient use of system resources. Many of today's operating systems support such techniques as *multiprogramming*, *multithreading*, and *multiprocessing* to increase system performance.

Multiprogramming allows multiple programs to run simultaneously by sharing the same CPU. The CPU is much faster than the computer's other components. As a result, it is idle most of the time—for example, while waiting for data to be transferred from a disk or waiting for other system resources to respond. A multiprogramming OS takes advantage of this situation by allowing multiple programs to use the CPU when it would otherwise be idle. For example, multiprogramming enables you to use a word processor to edit a file at the same time as your Web browser is downloading a file.

multiprogramming

Multithreading allows a single program to execute multiple tasks at the same time. For instance, a word-processing program allows users to simultaneously edit text and save it to a disk. In this example, editing and saving are two tasks within the same application. These two tasks may run concurrently.

multithreading

Multiprocessing, or *parallel processing*, uses two or more processors together to perform subtasks concurrently and then combine solutions of the subtasks to obtain a solution for the entire task. It is like a surgical operation where several doctors work together on one patient.

multiprocessing

1.18 What is an operating system? List some popular operating systems.

1.19 What are the major responsibilities of an operating system?

1.20 What are multiprogramming, multithreading, and multiprocessing?



MyProgrammingLab™

1.5 Java, the World Wide Web, and Beyond

Java is a powerful and versatile programming language for developing software running on mobile devices, desktop computers, and servers.



This book introduces Java programming. Java was developed by a team led by James Gosling at Sun Microsystems. Sun Microsystems was purchased by Oracle in 2010. Originally called *Oak*, Java was designed in 1991 for use in embedded chips in consumer electronic appliances. In 1995, renamed *Java*, it was redesigned for developing Web applications. For the history of Java, see www.java.com/en/javahistory/index.jsp.

Java has become enormously popular. Its rapid rise and wide acceptance can be traced to its design characteristics, particularly its promise that you can write a program once and run it anywhere. As stated by its designer, Java is *simple, object oriented, distributed, interpreted, robust, secure, architecture neutral, portable, high performance, multithreaded*, and *dynamic*. For the anatomy of Java characteristics, see www.cs.armstrong.edu/liang/JavaCharacteristics.pdf.

Java is a full-featured, general-purpose programming language that can be used to develop robust mission-critical applications. Today, it is employed not only for Web programming, but also for developing standalone applications across platforms on servers, desktop computers, and mobile devices. It was used to develop the code to communicate with and control the robotic rover on Mars. Many companies that once considered Java to be more hype than substance are now using it to create distributed applications accessed by customers and partners across the Internet. For every new project being developed today, companies are asking how they can use Java to make their work easier.

The World Wide Web is an electronic information repository that can be accessed on the Internet from anywhere in the world. The Internet, the Web's infrastructure, has been around for more than forty years. The colorful World Wide Web and sophisticated Web browsers are the major reason for the Internet's popularity.

applet

HTML

Java initially became attractive because Java programs can be run from a Web browser. Such programs are called *applets*. Applets employ a modern graphical interface with buttons, text fields, text areas, radio buttons, and so on, to interact with users on the Web and process their requests. Applets make the Web responsive, interactive, and fun to use. Applets are embedded in an HTML file. *HTML (Hypertext Markup Language)* is a simple scripting language for laying out documents, linking documents on the Internet, and bringing images, sound, and video alive on the Web. Figure 1.11 shows an applet running from a Web browser for playing a tic-tac-toe game.

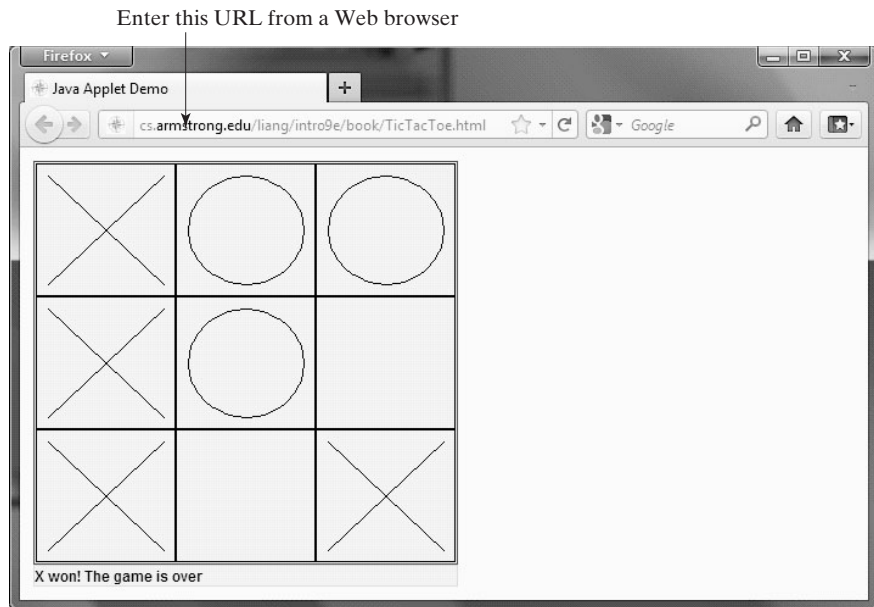


FIGURE 1.11 A Java applet for playing tic-tac-toe runs from a Web browser.



Tip

For a demonstration of Java applets, visit java.sun.com/applets. This site provides a rich Java resource as well as links to other cool applet demo sites.

Java is now very popular for developing applications on Web servers. These applications process data, perform computations, and generate dynamic Web pages. The LiveLab automatic grading system, shown in Figure 1.12 and which you can use with this book, was developed using Java.

Java is a versatile programming language: You can use it to develop applications for desktop computers, servers, and small hand-held devices. The software for Android cell phones is developed using Java. Figure 1.13 shows an emulator for developing Android phone applications.



MyProgrammingLab™

- 1.21** Who invented Java? Which company owns Java now?
1.22 What is a Java applet?
1.23 What programming language does Android use?

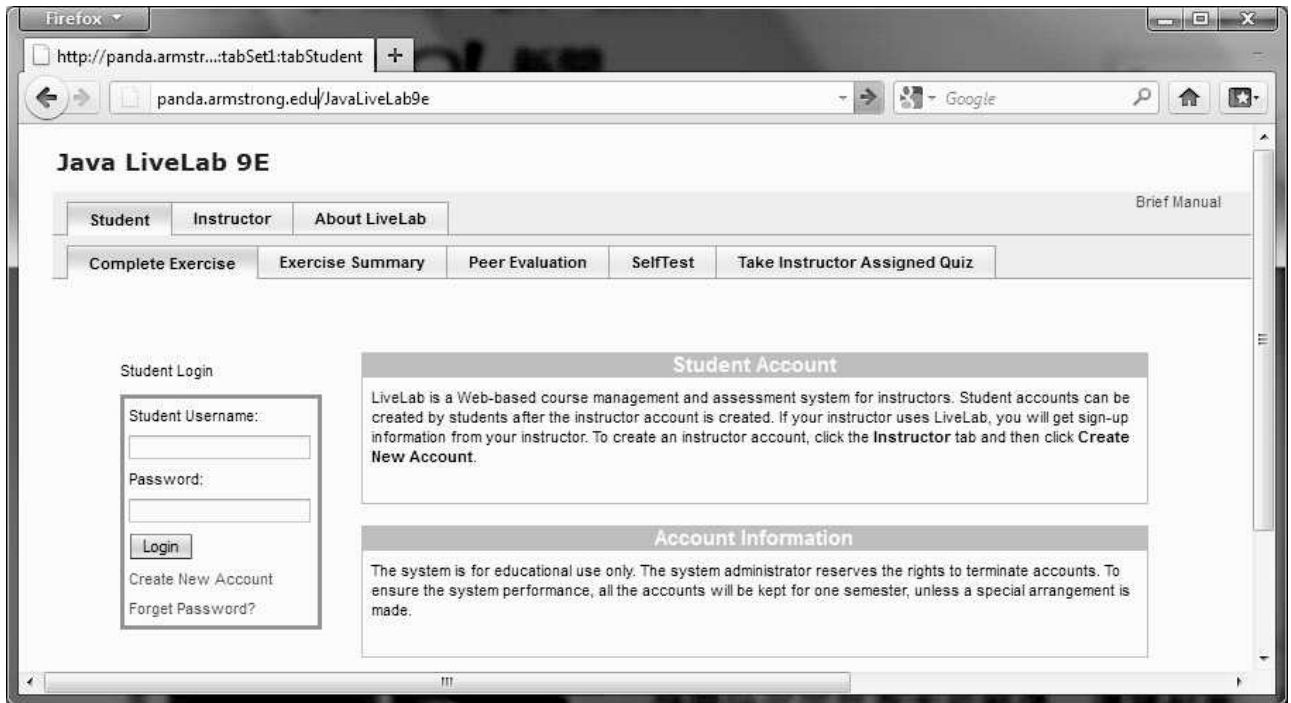


FIGURE I.12 Java was used to develop LiveLab, the automatic grading system that accompanies this book.



FIGURE I.13 Java is used in Android phones.

1.6 The Java Language Specification, API, JDK, and IDE



Java syntax is defined in the Java language specification, and the Java library is defined in the Java API. The JDK is the software for developing and running Java programs. An IDE is an integrated development environment for rapidly developing programs.

Computer languages have strict rules of usage. If you do not follow the rules when writing a program, the computer will not be able to understand it. The Java language specification and the Java API define the Java standards.

Java language specification

The *Java language specification* is a technical definition of the Java programming language's syntax and semantics. You can find the complete Java language specification at java.sun.com/docs/books/jls.

API
library

The *application program interface (API)*, also known as *library*, contains predefined classes and interfaces for developing Java programs. The API is still expanding. You can view and download the latest version of the Java API at www.oracle.com/technetwork/java/index.html.

Java is a full-fledged and powerful language that can be used in many ways. It comes in three editions:

Java SE, EE, and ME

- *Java Standard Edition (Java SE)* to develop client-side standalone applications or applets.
- *Java Enterprise Edition (Java EE)* to develop server-side applications, such as Java servlets, JavaServer Pages (JSP), and JavaServer Faces (JSF).
- *Java Micro Edition (Java ME)* to develop applications for mobile devices, such as cell phones.

This book uses Java SE to introduce Java programming. Java SE is the foundation upon which all other Java technology is based. There are many versions of Java SE. The latest, Java SE 7, is used in this book. Oracle releases each version with a *Java Development Toolkit (JDK)*. For Java SE 7, the Java Development Toolkit is called *JDK 1.7* (also known as *Java 7* or *JDK 7*).

Java Development Toolkit
(JDK)
JDK 1.7 = JDK 7

The JDK consists of a set of separate programs, each invoked from a command line, for developing and testing Java programs. Instead of using the JDK, you can use a Java development tool (e.g., NetBeans, Eclipse, and TextPad)—software that provides an *integrated development environment (IDE)* for developing Java programs quickly. Editing, compiling, building, debugging, and online help are integrated in one graphical user interface. You simply enter source code in one window or open an existing file in a window, and then click a button or menu item or press a function key to compile and run the program.

Integrated development
environment



1.24 What is the Java language specification?

1.25 What does JDK stand for?

1.26 What does IDE stand for?

1.27 Are tools like NetBeans and Eclipse different languages from Java, or are they dialects or extensions of Java?

MyProgrammingLab™

1.7 A Simple Java Program



*A Java program is executed from the **main** method in the class.*

what is a console?
console input
console output

Let's begin with a simple Java program that displays the message **Welcome to Java!** on the console. (The word *console* is an old computer term that refers to the text entry and display device of a computer. *Console input* means to receive input from the keyboard, and *console output* means to display output on the monitor.) The program is shown in Listing 1.1.

LISTING I.1 Welcome.java

```

1 public class Welcome {
2     public static void main(String[] args) {
3         // Display message Welcome to Java! on the console
4         System.out.println("Welcome to Java!");
5     }
6 }

```

class
main method
display message



VideoNote
Your first Java program



```
Welcome to Java!
```

Note that the line numbers are for reference purposes only; they are not part of the program. So, don't type line numbers in your program.

line numbers

Line 1 defines a class. Every Java program must have at least one class. Each class has a name. By convention, class names start with an uppercase letter. In this example, the class name is **Welcome**.

class name

Line 2 defines the **main** method. The program is executed from the **main** method. A class may contain several methods. The **main** method is the entry point where the program begins execution.

main method

A method is a construct that contains statements. The **main** method in this program contains the **System.out.println** statement. This statement displays the string **Welcome to Java!** on the console (line 4). *String* is a programming term meaning a sequence of characters. A string must be enclosed in double quotation marks. Every statement in Java ends with a semicolon (;), known as the *statement terminator*.

string

statement terminator

Reserved words, or *keywords*, have a specific meaning to the compiler and cannot be used for other purposes in the program. For example, when the compiler sees the word **class**, it understands that the word after **class** is the name for the class. Other reserved words in this program are **public**, **static**, and **void**.

reserved word

keyword

Line 3 is a *comment* that documents what the program is and how it is constructed. Comments help programmers to communicate and understand the program. They are not programming statements and thus are ignored by the compiler. In Java, comments are preceded by two slashes (//) on a line, called a *line comment*, or enclosed between /* and */ on one or several lines, called a *block comment* or *paragraph comment*. When the compiler sees //, it ignores all text after // on the same line. When it sees /*, it scans for the next */ and ignores any text between /* and */. Here are examples of comments:

comment

line comment

block comment

```

// This application program displays Welcome to Java!
/* This application program displays Welcome to Java! */
/* This application program
   displays Welcome to Java! */

```

A pair of curly braces in a program forms a *block* that groups the program's components. In Java, each block begins with an opening brace ({) and ends with a closing brace (}). Every class has a *class block* that groups the data and methods of the class. Similarly, every method has a *method block* that groups the statements in the method. Blocks can be *nested*, meaning that one block can be placed within another, as shown in the following code.

block

**Tip**

An opening brace must be matched by a closing brace. Whenever you type an opening brace, immediately type a closing brace to prevent the missing-brace error. Most Java IDEs automatically insert the closing brace for each opening brace.

match braces

```
public class Welcome {
    public static void main(String[] args) {
        System.out.println("Welcome to Java!");
    }
}
```

← Class block (encloses the entire code block)

← Method block (encloses the main method)

case sensitive

special characters



Caution

Java source programs are case sensitive. It would be wrong, for example, to replace `main` in the program with `Main`.

You have seen several special characters (e.g., `{ }`, `//`, `;`) in the program. They are used in almost every program. Table 1.2 summarizes their uses.

TABLE 1.2 Special Characters

Character	Name	Description
{ }	Opening and closing braces	Denote a block to enclose statements.
()	Opening and closing parentheses	Used with methods.
[]	Opening and closing brackets	Denote an array.
//	Double slashes	Precede a comment line.
" "	Opening and closing quotation marks	Enclose a string (i.e., sequence of characters).
;	Semicolon	Mark the end of a statement.

common errors

syntax rules

The most common errors you will make as you learn to program will be syntax errors. Like any programming language, Java has its own syntax, and you need to write code that conforms to the *syntax rules*. If your program violates a rule—for example, if the semicolon is missing, a brace is missing, a quotation mark is missing, or a word is misspelled—the Java compiler will report syntax errors. Try to compile the program with these errors and see what the compiler reports.



Note

You are probably wondering why the `main` method is defined this way and why `System.out.println(...)` is used to display a message on the console. For the time being, simply accept that this is how things are done. Your questions will be fully answered in subsequent chapters.

The program in Listing 1.1 displays one message. Once you understand the program, it is easy to extend it to display more messages. For example, you can rewrite the program to display three messages, as shown in Listing 1.2.

LISTING 1.2 WelcomeWithThreeMessages.java

class
main method
display message

```
1 public class WelcomeWithThreeMessages {
2     public static void main(String[] args) {
3         System.out.println("Programming is fun!");
4         System.out.println("Fundamentals First");
5         System.out.println("Problem Driven");
6     }
7 }
```



```
Programming is fun!
Fundamentals First
Problem Driven
```

Further, you can perform mathematical computations and display the result on the console.

Listing 1.3 gives an example of evaluating $\frac{10.5 + 2 \times 3}{45 - 3.5}$.

LISTING 1.3 ComputeExpression.java

```
1 public class ComputeExpression {
2     public static void main(String[] args) {
3         System.out.println((10.5 + 2 * 3) / (45 - 3.5));
4     }
5 }
```

class
main method
compute expression

0.39759036144578314



The multiplication operator in Java is `*`. As you can see, it is a straightforward process to translate an arithmetic expression to a Java expression. We will discuss Java expressions further in Chapter 2.

- 1.28** What is a keyword? List some Java keywords.
- 1.29** Is Java case sensitive? What is the case for Java keywords?
- 1.30** What is a comment? Is the comment ignored by the compiler? How do you denote a comment line and a comment paragraph?
- 1.31** What is the statement to display a string on the console?
- 1.32** Show the output of the following code:

```
public class Test {
    public static void main(String[] args) {
        System.out.println("3.5 * 4 / 2 - 2.5 is ");
        System.out.println(3.5 * 4 / 2 - 2.5);
    }
}
```



MyProgrammingLab™

1.8 Creating, Compiling, and Executing a Java Program

You save a Java program in a .java file and compile it into a .class file. The .class file is executed by the Java Virtual Machine.



You have to create your program and compile it before it can be executed. This process is repetitive, as shown in Figure 1.14. If your program has compile errors, you have to modify the program to fix them, then recompile it. If your program has runtime errors or does not produce the correct result, you have to modify the program, recompile it, and execute it again.



VideoNote
Eclipse brief tutorial

You can use any text editor or IDE to create and edit a Java source-code file. This section demonstrates how to create, compile, and run Java programs from a command window. If you wish to use an *IDE* such as Eclipse, NetBeans, or TextPad, refer to Supplement II for tutorials. From the command window, you can use a text editor such as Notepad to create the Java source-code file, as shown in Figure 1.15.

command window
IDE Supplements



Note

The source file must end with the extension `.java` and must have the same exact name as the public class name. For example, the file for the source code in Listing 1.1 should be named `Welcome.java`, since the public class name is `Welcome`.



VideoNote
NetBeans brief tutorial

file name

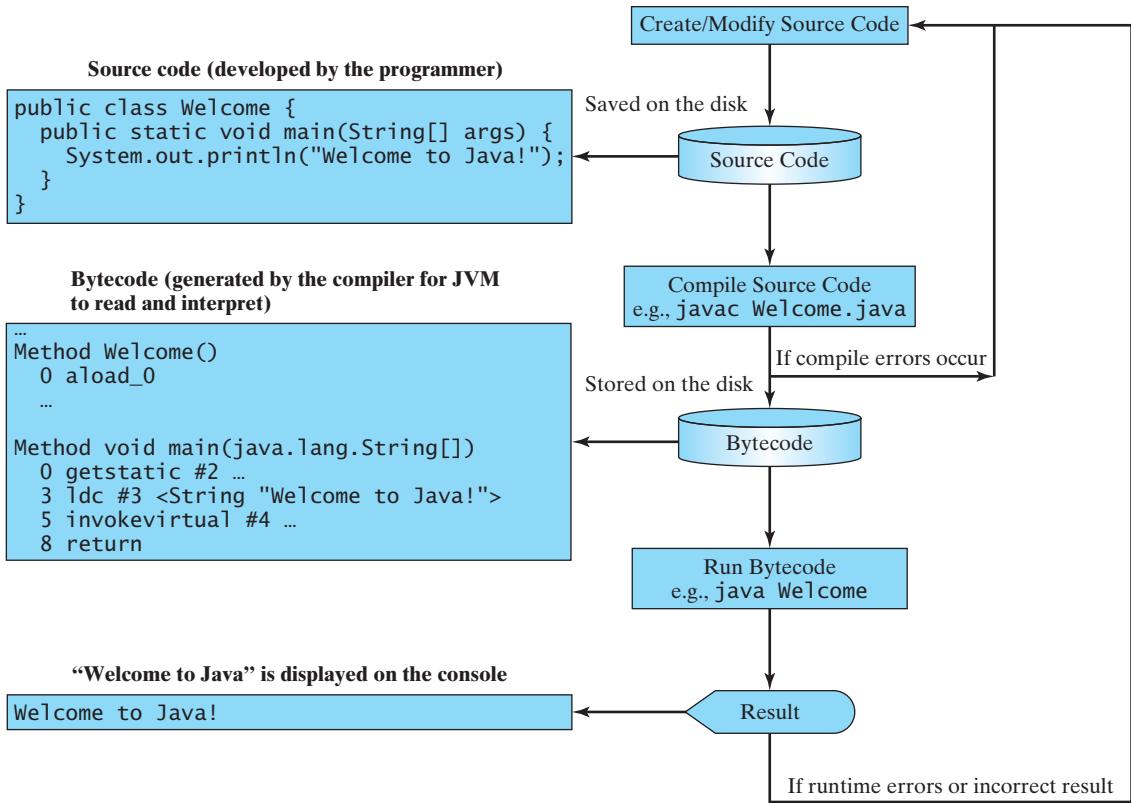


FIGURE I.14 The Java program-development process consists of repeatedly creating/modifying source code, compiling, and executing programs.

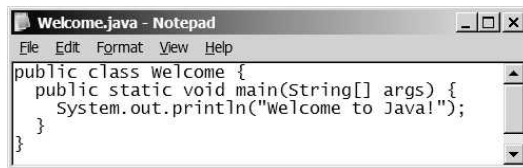


FIGURE I.15 You can create a Java source file using Windows Notepad.

A Java compiler translates a Java source file into a Java bytecode file. The following command compiles **Welcome.java**:

```
javac Welcome.java
```



Note

You must first install and configure the JDK before you can compile and run programs. See Supplement I.B, *Installing and Configuring JDK 7*, for how to install the JDK and set up the environment to compile and run Java programs. If you have trouble compiling and running programs, see Supplement I.C, *Compiling and Running Java from the Command Window*. This supplement also explains how to use basic DOS commands and how to use Windows Notepad and WordPad to create and edit files. All the supplements are accessible from the Companion Website.

Supplement I.B

Supplement I.C

.class bytecode file

If there aren't any syntax errors, the *compiler* generates a bytecode file with a **.class** extension. Thus, the preceding command generates a file named **Welcome.class**, as shown in

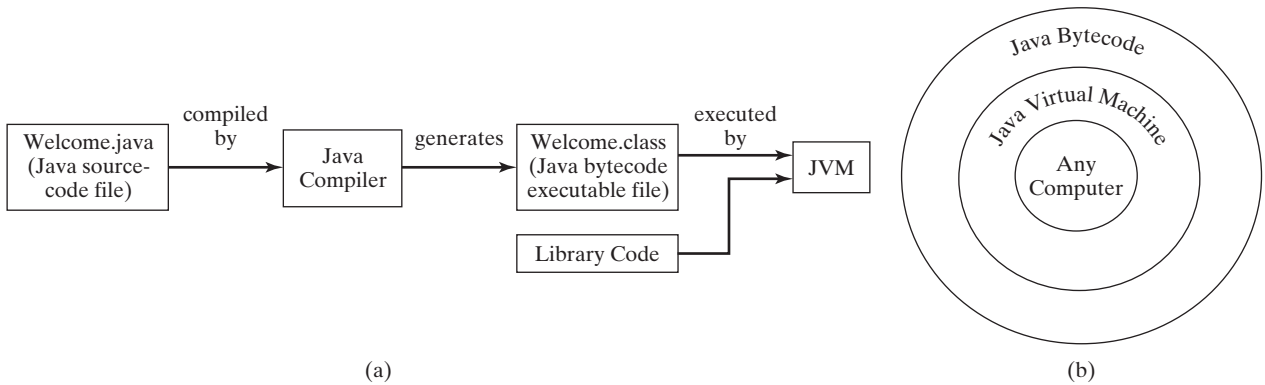


FIGURE 1.16 (a) Java source code is translated into bytecode. (b) Java bytecode can be executed on any computer with a Java Virtual Machine.

Figure 1.16a. The Java language is a high-level language, but Java bytecode is a low-level language. The *bytecode* is similar to machine instructions but is architecture neutral and can run on any platform that has a *Java Virtual Machine (JVM)*, as shown in Figure 1.16b. Rather than a physical machine, the virtual machine is a program that interprets Java bytecode. This is one of Java’s primary advantages: *Java bytecode can run on a variety of hardware platforms and operating systems*. Java source code is compiled into Java bytecode and Java bytecode is interpreted by the JVM. Your Java code may use the code in the Java library. The JVM executes your code along with the code in the library.

To execute a Java program is to run the program’s bytecode. You can execute the bytecode on any platform with a JVM, which is an interpreter. It translates the individual instructions in the bytecode into the target machine language code one at a time rather than the whole program as a single unit. Each step is executed immediately after it is translated.

The following command runs the bytecode for Listing 1.1:

```
java Welcome
```

Figure 1.17 shows the **javac** command for compiling **Welcome.java**. The compiler generates the **Welcome.class** file, and this file is executed using the **java** command.



Note

For simplicity and consistency, all source-code and class files used in this book are placed under **c:\book** unless specified otherwise.

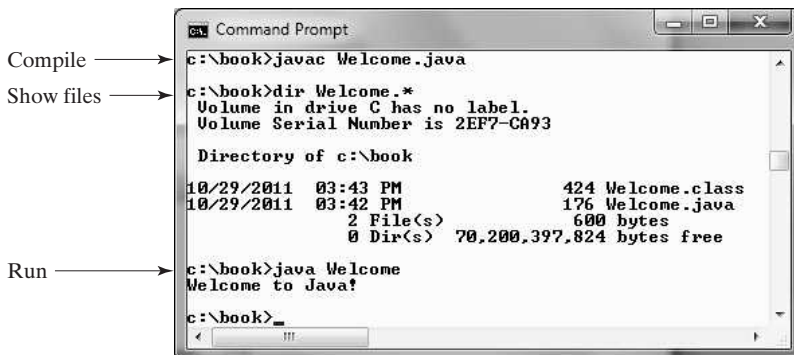


FIGURE 1.17 The output of Listing 1.1 displays the message “Welcome to Java!”

bytecode
Java Virtual Machine (JVM)

interpret bytecode

run

javac command
java command

c:\book



VideoNote
Compile and run a Java program

java ClassName



Caution

Do not use the extension `.class` in the command line when executing the program. Use `java ClassName` to run the program. If you use `java ClassName.class` in the command line, the system will attempt to fetch `ClassName.class.class`.

NoClassDefFoundError



Tip

If you execute a class file that does not exist, a `NoClassDefFoundError` will occur. If you execute a class file that does not have a `main` method or you mistype the `main` method (e.g., by typing `Main` instead of `main`), a `NoSuchMethodError` will occur.

NoSuchMethodError

class loader



Note

When executing a Java program, the JVM first loads the bytecode of the class to memory using a program called the *class loader*. If your program uses other classes, the class loader dynamically loads them just before they are needed. After a class is loaded, the JVM uses a program called the *bytecode verifier* to check the validity of the bytecode and to ensure that the bytecode does not violate Java's security restrictions. Java enforces strict security to make sure that Java class files are not tampered and do not harm your computer.

bytecode verifier

use package



Pedagogical Note

Your instructor may require you to use packages for organizing programs. For example, you may place all programs in this chapter in a package named *chapter1*. For instructions on how to use packages, see Supplement I.F, Using Packages to Organize the Classes in the Text.



Check Point

MyProgrammingLab™

- I.33** What is the Java source filename extension, and what is the Java bytecode filename extension?
- I.34** What are the input and output of a Java compiler?
- I.35** What is the command to compile a Java program?
- I.36** What is the command to run a Java program?
- I.37** What is the JVM?
- I.38** Can Java run on any machine? What is needed to run Java on a computer?
- I.39** If a `NoClassDefFoundError` occurs when you run a program, what is the cause of the error?
- I.40** If a `NoSuchMethodError` occurs when you run a program, what is the cause of the error?

1.9 Displaying Text in a Message Dialog Box



Key Point

You can display text in a graphical dialog box.

JOptionPane

showMessageDialog

The program in Listing 1.1 displays the text on the console, as shown in Figure 1.17. You can rewrite the program to display the text in a message dialog box. To do so, you need to use the `showMessageDialog` method in the `JOptionPane` class. `JOptionPane` is one of the many predefined classes in the Java library that you can reuse rather than “reinvent the wheel.” You can use the `showMessageDialog` method to display any text in a message dialog box, as shown in Figure 1.18. The new program is given in Listing 1.4.

block comment

LISTING 1.4 WelcomeInMessageDialogBox.java

```

1  /* This application program displays Welcome to Java!
2  *   in a message dialog box.
3  */

```

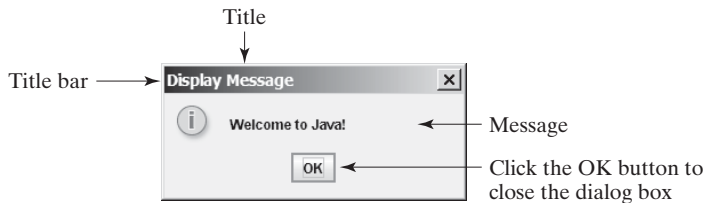


FIGURE 1.18 “Welcome to Java!” is displayed in a message box.

```

4  import javax.swing.JOptionPane;           import
5
6  public class WelcomeInMessageDialogBox {
7      public static void main(String[] args) {           main method
8          // Display Welcome to Java! in a message dialog box
9          JOptionPane.showMessageDialog(null, "Welcome to Java!");           display message
10     }
11 }

```

The first three lines are block comments. The first line begins with `/*` and the last line ends with `*/`. By convention, all other lines begin with an asterisk (`*`).

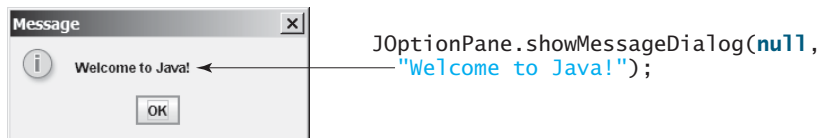
This program uses the Java class `JOptionPane` (line 9). Java’s predefined classes are grouped into packages. `JOptionPane` is in the `javax.swing` package. `JOptionPane` is imported into the program using the `import` statement in line 4 so that the compiler can locate the class without the full name `javax.swing.JOptionPane`. package



Note

If you replace `JOptionPane` in line 9 with `javax.swing.JOptionPane`, you don’t need to import it in line 4. `javax.swing.JOptionPane` is the full name for the `JOptionPane` class.

The `showMessageDialog` method is a *static* method. Such a method should be invoked by using the class name followed by a dot operator (`.`) and the method name with arguments. Details of methods will be discussed in Chapter 5. The `showMessageDialog` method can be invoked with two arguments, as shown below.



```

JOptionPane.showMessageDialog(null,
    "Welcome to Java!");

```

The first argument can always be `null`. `null` is a Java keyword that will be fully discussed in Chapter 8. The second argument is a string for text to be displayed.


There are several ways to use the `showMessageDialog` method. For the time being, you need to know only two ways. One is to use a statement, as shown in the example: two versions of `showMessageDialog`

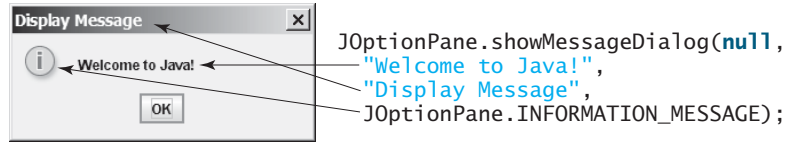
```
JOptionPane.showMessageDialog(null, x);
```

where `x` is a string for the text to be displayed.

The other is to use a statement like this one:

```
JOptionPane.showMessageDialog(null, x,
    y, JOptionPane.INFORMATION_MESSAGE);
```

where **x** is a string for the text to be displayed, and **y** is a string for the title of the message box. The fourth argument can be `JOptionPane.INFORMATION_MESSAGE`, which causes the information icon () to be displayed in the message box, as shown in the following example.



specific import



Note

There are two types of **import** statements: *specific import* and *wildcard import*. The *specific import* specifies a single class in the import statement. For example, the following statement imports `JOptionPane` from the package `javax.swing`.

```
import javax.swing.JOptionPane;
```

wildcard import

The *wildcard import* imports all the classes in a package by using the asterisk as the wildcard. For example, the following statement imports all the classes from the package `javax.swing`.

```
import javax.swing.*;
```

no performance difference

The information for the classes in an imported package is not read in at compile time or runtime unless the class is used in the program. The import statement simply tells the compiler where to locate the classes. There is no performance difference between a specific import and a wildcard import declaration.

java.lang package implicitly imported



Note

Recall that you have used the `System` class in the statement `System.out.println("Welcome to Java");` in Listing 1.1. The `System` class is not imported because it is in the `java.lang` package. All the classes in the `java.lang` package are *implicitly* imported in every Java program.



- 1.41** What is the statement to display the message “Hello world” in a message dialog box?
- 1.42** Why does the `System` class not need to be imported?
- 1.43** Are there any performance differences between the following two **import** statements?

```
import javax.swing.JOptionPane;
import javax.swing.*;
```

MyProgrammingLab™

1.10 Programming Style and Documentation



Good programming style and proper documentation make a program easy to read and help programmers prevent errors.

programming style

documentation

Programming style deals with what programs look like. A program can compile and run properly even if written on only one line, but writing it all on one line would be bad programming style because it would be hard to read. *Documentation* is the body of explanatory remarks and comments pertaining to a program. Programming style and documentation are as important as coding. Good programming style and appropriate documentation reduce the chance of errors and make programs easy to read. This section gives several guidelines. For

more detailed guidelines, see Supplement I.D, Java Coding Style Guidelines, on the Companion Website.

I.10.1 Appropriate Comments and Comment Styles

Include a summary at the beginning of the program that explains what the program does, its key features, and any unique techniques it uses. In a long program, you should also include comments that introduce each major step and explain anything that is difficult to read. It is important to make comments concise so that they do not crowd the program or make it difficult to read.

In addition to line comments (beginning with `//`) and block comments (beginning with `/*`), Java supports comments of a special type, referred to as *javadoc comments*. javadoc comments begin with `/**` and end with `*/`. They can be extracted into an HTML file using the JDK's `javadoc` command. For more information, see java.sun.com/j2se/javadoc.

javadoc comment

Use javadoc comments (`/** ... */`) for commenting on an entire class or an entire method. These comments must precede the class or the method header in order to be extracted into a javadoc HTML file. For commenting on steps inside a method, use line comments (`//`). To see an example of a javadoc HTML file, check out www.cs.armstrong.edu/liang/javadoc/Exercise1.html. Its corresponding Java code is shown in www.cs.armstrong.edu/liang/javadoc/Exercise1.java.

I.10.2 Proper Indentation and Spacing

A consistent indentation style makes programs clear and easy to read, debug, and maintain. *Indentation* is used to illustrate the structural relationships between a program's components or statements. Java can read the program even if all of the statements are on the same long line, but humans find it easier to read and maintain code that is aligned properly. Indent each sub-component or statement at least *two* spaces more than the construct within which it is nested.

indent code

A single space should be added on both sides of a binary operator, as shown in the following statement:

<code>System.out.println(3+4*4);</code>	← Bad style
<code>System.out.println(3 + 4 * 4);</code>	← Good style

I.10.3 Block Styles

A *block* is a group of statements surrounded by braces. There are two popular styles, *next-line* style and *end-of-line* style, as shown below.

```
public class Test
{
    public static void main(String[] args)
    {
        System.out.println("Block Styles");
    }
}
```

Next-line style

```
public class Test {
    public static void main(String[] args) {
        System.out.println("Block Styles");
    }
}
```

End-of-line style

The next-line style aligns braces vertically and makes programs easy to read, whereas the end-of-line style saves space and may help avoid some subtle programming errors. Both are acceptable block styles. The choice depends on personal or organizational preference. You should use a block style consistently—mixing styles is not recommended. This book uses the *end-of-line* style to be consistent with the Java API source code.



I.44 Reformat the following program according to the programming style and documentation guidelines. Use the end-of-line brace style.

MyProgrammingLab™

```
public class Test
{
    // Main method
    public static void main(String[] args) {
        /** Display output */
        System.out.println("Welcome to Java");
    }
}
```

1.11 Programming Errors



Programming errors can be categorized into three types: syntax errors, runtime errors, and logic errors.

1.11.1 Syntax Errors

syntax errors
compile errors

Errors that are detected by the compiler are called *syntax errors* or *compile errors*. Syntax errors result from errors in code construction, such as mistyping a keyword, omitting some necessary punctuation, or using an opening brace without a corresponding closing brace. These errors are usually easy to detect, because the compiler tells you where they are and what caused them. For example, the program in Listing 1.5 has a syntax error, as shown in Figure 1.19.

LISTING 1.5 ShowSyntaxErrors.java

```
1 public class ShowSyntaxErrors {
2     public static main(String[] args) {
3         System.out.println("Welcome to Java");
4     }
5 }
```

Four errors are reported, but the program actually has two errors:

- The keyword **void** is missing before **main** in line 2.
- The string **Welcome to Java** should be closed with a closing quotation mark in line 3.

Since a single error will often display many lines of compile errors, it is a good practice to fix errors from the top line and work downward. Fixing errors that occur earlier in the program may also fix additional errors that occur later.

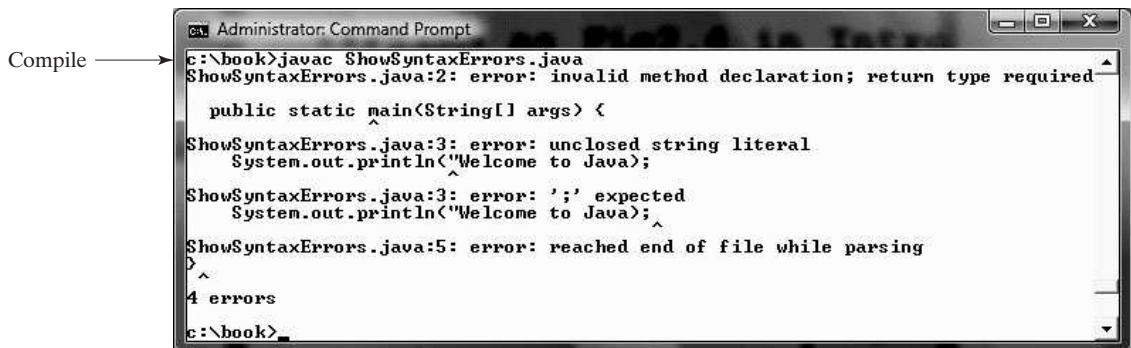


FIGURE 1.19 The compiler reports syntax errors.

**Tip**

If you don't know how to correct it, compare your program closely, character by character, with similar examples in the text. In the first few weeks of this course, you will probably spend a lot of time fixing syntax errors. Soon you will be familiar with Java syntax and can quickly fix syntax errors.

fix syntax errors

1.11.2 Runtime Errors

Runtime errors are errors that cause a program to terminate abnormally. They occur while a program is running if the environment detects an operation that is impossible to carry out. Input mistakes typically cause runtime errors. An *input error* occurs when the program is waiting for the user to enter a value, but the user enters a value that the program cannot handle. For instance, if the program expects to read in a number, but instead the user enters a string, this causes data-type errors to occur in the program.

runtime errors

Another example of runtime errors is division by zero. This happens when the divisor is zero for integer divisions. For instance, the program in Listing 1.6 would cause a runtime error, as shown in Figure 1.20.

LISTING 1.6 ShowRuntimeErrors.java

```
1 public class ShowRuntimeErrors {
2     public static void main(String[] args) {
3         System.out.println(1 / 0);
4     }
5 }
```

runtime error

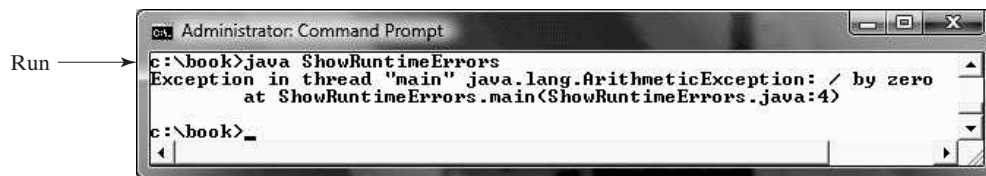


FIGURE 1.20 The runtime error causes the program to terminate abnormally.

1.11.3 Logic Errors

Logic errors occur when a program does not perform the way it was intended to. Errors of this kind occur for many different reasons. For example, suppose you wrote the program in Listing 1.7 to convert Celsius 35 degrees to a Fahrenheit degree:

logic errors

LISTING 1.7 ShowLogicErrors.java

```
1 public class ShowLogicErrors {
2     public static void main(String[] args) {
3         System.out.println("Celsius 35 is Fahrenheit degree ");
4         System.out.println((9 / 5) * 35 + 32);
5     }
6 }
```

Celsius 35 is Fahrenheit degree
67



You will get Fahrenheit **67** degrees, which is wrong. It should be **95.0**. In Java, the division for integers is an integer—the fractional part is truncated—so in Java **9 / 5** is **1**. To get the correct result, you need to use **9.0 / 5**, which results in **1.8**.

In general, syntax errors are easy to find and easy to correct, because the compiler gives indications as to where the errors came from and why they are wrong. Runtime errors are not difficult to find, either, since the reasons and locations for the errors are displayed on the console when the program aborts. Finding logic errors, on the other hand, can be very challenging. In the upcoming chapters, you will learn the techniques of tracing programs and finding logic errors.



MyProgrammingLab™

- 1.45** What are syntax errors (compile errors), runtime errors, and logic errors?
- 1.46** Give examples of syntax errors, runtime errors, and logic errors.
- 1.47** If you forget to put a closing quotation mark on a string, what kind error will be raised?
- 1.48** If your program needs to read integers, but the user entered strings, an error would occur when running this program. What kind of error is this?
- 1.49** Suppose you write a program for computing the perimeter of a rectangle and you mistakenly write your program so that it computes the area of a rectangle. What kind of error is this?
- 1.50** Identify and fix the errors in the following code:

```
1 public class Welcome {
2     public void Main(String[] args) {
3         System.out.println('Welcome to Java!');
4     }
5 }
```

- 1.51** The following program is wrong. Reorder the lines so that the program displays **morning** followed by **afternoon**.

```
1 public static void main(String[] args) {
2     }
3 public class Welcome {
4     System.out.println("afternoon");
5     System.out.println("morning");
6 }
```

KEY TERMS

Application Program Interface (API)	16	dot pitch	8
assembler	10	DSL (digital subscriber line)	8
assembly language	10	encoding scheme	4
bit	4	hardware	2
block	17	high-level language	10
block comment	17	integrated development environment (IDE)	16
bus	2	interpreter	10
byte	4	java command	21
bytecode	21	Java Development Toolkit (JDK)	16
bytecode verifier	22	Java language specification	16
cable modem	8	Java Virtual Machine (JVM)	21
central processing unit (CPU)	3	javac command	21
class loader	22	keyword (or reserved word)	17
comment	17	library	16
compiler	10	line comment	17
console	16		

logic error	27	programming	2
low-level language	10	runtime error	27
machine language	9	screen resolution	8
main method	17	software	2
memory	5	source code	10
modem	8	source program	10
motherboard	3	specific import	24
network interface card (NIC)	8	statement	10
operating system (OS)	12	storage devices	5
pixel	8	syntax error	26
program	2	wildcard import	24



Note

The above terms are defined in this chapter. Supplement I.A, Glossary, lists all the key terms and descriptions in the book, organized by chapters.

Supplement I.A

CHAPTER SUMMARY

1. A computer is an electronic device that stores and processes data.
2. A computer includes both *hardware* and *software*.
3. Hardware is the physical aspect of the computer that can be touched.
4. Computer *programs*, known as *software*, are the invisible instructions that control the hardware and make it perform tasks.
5. Computer *programming* is the writing of instructions (i.e., code) for computers to perform.
6. The *central processing unit (CPU)* is a computer's brain. It retrieves instructions from *memory* and executes them.
7. Computers use zeros and ones because digital devices have two stable states, referred to by convention as zero and one.
8. A *bit* is a binary digit 0 or 1.
9. A *byte* is a sequence of 8 bits.
10. A kilobyte is about 1,000 bytes, a megabyte about 1 million bytes, a gigabyte about 1 billion bytes, and a terabyte about 1,000 gigabytes.
11. Memory stores data and program instructions for the CPU to execute.
12. A memory unit is an ordered sequence of bytes.
13. Memory is volatile, because information is lost when the power is turned off.

14. Programs and data are permanently stored on *storage devices* and are moved to memory when the computer actually uses them.
15. The *machine language* is a set of primitive instructions built into every computer.
16. *Assembly language* is a *low-level programming language* in which a mnemonic is used to represent each machine-language instruction.
17. *High-level languages* are English-like and easy to learn and program.
18. A program written in a high-level language is called a *source program*.
19. A *compiler* is a software program that translates the source program into a *machine-language program*.
20. The *operating system (OS)* is a program that manages and controls a computer's activities.
21. Java is platform independent, meaning that you can write a program once and run it on any computer.
22. Java programs can be embedded in HTML pages and downloaded by Web browsers to bring live animation and interaction to Web clients.
23. The Java source file name must match the public class name in the program. Java source code files must end with the **.java** extension.
24. Every class is compiled into a separate bytecode file that has the same name as the class and ends with the **.class** extension.
25. To compile a Java source-code file from the command line, use the *javac command*.
26. To run a Java class from the command line, use the *java command*.
27. Every Java program is a set of class definitions. The keyword **class** introduces a class definition. The contents of the class are included in a *block*.
28. A block begins with an opening brace (**{**) and ends with a closing brace (**}**).
29. Methods are contained in a class. To run a Java program, the program must have a **main** method. The **main** method is the entry point where the program starts when it is executed.
30. Every *statement* in Java ends with a semicolon (**;**), known as the *statement terminator*.
31. *Reserved words*, or *keywords*, have a specific meaning to the compiler and cannot be used for other purposes in the program.
32. In Java, comments are preceded by two slashes (**//**) on a line, called a *line comment*, or enclosed between **/*** and ***/** on one or several lines, called a *block comment* or *paragraph comment*. Comments are ignored by the compiler.
33. Java source programs are case sensitive.

34. There are two types of **import** statements: *specific import* and *wildcard import*. The specific import specifies a single class in the import statement; the wildcard import imports all the classes in a package.
35. Programming errors can be categorized into three types: *syntax errors*, *runtime errors*, and *logic errors*. Errors that occur during compilation are called syntax errors or *compile errors*. Runtime errors are errors that cause a program to terminate abnormally. Logic errors occur when a program does not perform the way it was intended to.

TEST QUESTIONS

Do the test questions for this chapter online at www.cs.armstrong.edu/liang/intro9e/test.html.

PROGRAMMING EXERCISES

MyProgrammingLab™



Note

Solutions to even-numbered exercises are on the Companion Website. Solutions to all exercises are on the Instructor Resource Website. The level of difficulty is rated easy (no star), moderate (*), hard (**), or challenging (***)

level of difficulty

- 1.1 (*Display three messages*) Write a program that displays **Welcome to Java**, **Welcome to Computer Science**, and **Programming is fun**.
- 1.2 (*Display five messages*) Write a program that displays **Welcome to Java** five times.
- *1.3 (*Display a pattern*) Write a program that displays the following pattern:

```

      J   A   V   V   A
      J   A A  V   V   A A
J     J   AAAAA  V V   AAAAA
J J   A     A   V   A     A

```

- 1.4 (*Print a table*) Write a program that displays the following table:

a	a ²	a ³
1	1	1
2	4	8
3	9	27
4	16	64

- 1.5 (*Compute expressions*) Write a program that displays the result of

$$\frac{9.5 \times 4.5 - 2.5 \times 3}{45.5 - 3.5}$$

- 1.6 (*Summation of a series*) Write a program that displays the result of

$$1 + 2 + 3 + 4 + 5 + 6 + 7 + 8 + 9.$$

- 1.7 (*Approximate π*) π can be computed using the following formula:

$$\pi = 4 \times \left(1 - \frac{1}{3} + \frac{1}{5} - \frac{1}{7} + \frac{1}{9} - \frac{1}{11} + \dots \right)$$

Write a program that displays the result of $4 \times \left(1 - \frac{1}{3} + \frac{1}{5} - \frac{1}{7} + \frac{1}{9} - \frac{1}{11} \right)$

and $4 \times \left(1 - \frac{1}{3} + \frac{1}{5} - \frac{1}{7} + \frac{1}{9} - \frac{1}{11} + \frac{1}{13} \right)$. Use 1.0 instead of 1 in your program.

- 1.8** (*Area and perimeter of a circle*) Write a program that displays the area and perimeter of a circle that has a radius of **5.5** using the following formula:

$$\text{perimeter} = 2 \times \text{radius} \times \pi$$

$$\text{area} = \text{radius} \times \text{radius} \times \pi$$

- 1.9** (*Area and perimeter of a rectangle*) Write a program that displays the area and perimeter of a rectangle with the width of **4.5** and height of **7.9** using the following formula:

$$\text{area} = \text{width} \times \text{height}$$

- 1.10** (*Average speed in miles*) Assume a runner runs **14** kilometers in **45** minutes and **30** seconds. Write a program that displays the average speed in miles per hour. (Note that **1** mile is **1.6** kilometers.)

- *1.11** (*Population projection*) The U.S. Census Bureau projects population based on the following assumptions:

- One birth every 7 seconds
- One death every 13 seconds
- One new immigrant every 45 seconds

Write a program to display the population for each of the next five years. Assume the current population is 312,032,486 and one year has 365 days. *Hint:* In Java, if two integers perform division, the result is an integer. The fraction part is truncated. For example, **5 / 4** is **1** (not **1.25**) and **10 / 4** is **2** (not **2.5**).

- 1.12** (*Average speed in kilometers*) Assume a runner runs **24** miles in **1** hour, **40** minutes, and **35** seconds. Write a program that displays the average speed in kilometers per hour. (Note that **1** mile is **1.6** kilometers.)

ELEMENTARY PROGRAMMING

Objectives

- To write Java programs to perform simple computations (§2.2).
- To obtain input from the console using the `Scanner` class (§2.3).
- To use identifiers to name variables, constants, methods, and classes (§2.4).
- To use variables to store data (§§2.5–2.6).
- To program with assignment statements and assignment expressions (§2.6).
- To use constants to store permanent data (§2.7).
- To name classes, methods, variables, and constants by following their naming conventions (§2.8).
- To explore Java numeric primitive data types: `byte`, `short`, `int`, `long`, `Float`, and `double` (§2.9.1).
- To perform operations using operators `+`, `-`, `*`, `/`, and `%` (§2.9.2).
- To perform exponent operations using `Math.pow(a, b)` (§2.9.3).
- To write integer literals, floating-point literals, and literals in scientific notation (§2.10).
- To write and evaluate numeric expressions (§2.11).
- To obtain the current system time using `System.currentTimeMillis()` (§2.12).
- To use augmented assignment operators (§2.13).
- To distinguish between postincrement and preincrement and between postdecrement and predecrement (§2.14).
- To cast the value of one type to another type (§2.15).
- To describe the software development process and apply it to develop the loan payment program (§2.16).
- To represent characters using the `char` type (§2.17).
- To represent a string using the `String` type (§2.18).
- To obtain input using the `JOptionPane` input dialog boxes (§2.19).



2.1 Introduction



The focus of this chapter is on learning elementary programming techniques to solve problems.

In Chapter 1 you learned how to create, compile, and run very basic Java programs. Now you will learn how to solve problems by writing programs. Through these problems, you will learn elementary programming using primitive data types, variables, constants, operators, expressions, and input and output.

Suppose, for example, that you need to take out a student loan. Given the loan amount, loan term, and annual interest rate, can you write a program to compute the monthly payment and total payment? This chapter shows you how to write programs like this. Along the way, you learn the basic steps that go into analyzing a problem, designing a solution, and implementing the solution by creating a program.

2.2 Writing a Simple Program



Writing a program involves designing a strategy for solving the problem and then using a programming language to implement that strategy.

problem

Let's first consider the simple problem of computing the area of a circle. How do we write a program for solving this problem?

algorithm

Writing a program involves designing algorithms and translating algorithms into programming instructions, or code. An *algorithm* describes how a problem is solved by listing the actions that need to be taken and the order of their execution. Algorithms can help the programmer plan a program before writing it in a programming language. Algorithms can be described in natural languages or in *pseudocode* (natural language mixed with some programming code). The algorithm for calculating the area of a circle can be described as follows:

pseudocode

1. Read in the circle's radius.
2. Compute the area using the following formula:

$$\text{area} = \text{radius} \times \text{radius} \times \pi$$

3. Display the result.



Tip

It's always good practice to outline your program (or its underlying problem) in the form of an algorithm before you begin coding.

When you *code*—that is, when you write a program—you translate an algorithm into a program. You already know that every Java program begins with a class definition in which the keyword `class` is followed by the class name. Assume that you have chosen `ComputeArea` as the class name. The outline of the program would look like this:

```
public class ComputeArea {
    // Details to be given later
}
```

As you know, every Java program must have a `main` method where program execution begins. The program is then expanded as follows:

```
public class ComputeArea {
    public static void main(String[] args) {
        // Step 1: Read in radius

        // Step 2: Compute area
    }
}
```

```

    // Step 3: Display the area
}
}

```

The program needs to read the radius entered by the user from the keyboard. This raises two important issues:

- Reading the radius.
- Storing the radius in the program.

Let's address the second issue first. In order to store the radius, the program needs to declare a symbol called a *variable*. A variable represents a value stored in the computer's memory.

Rather than using **x** and **y** as variable names, choose descriptive names: in this case, **radius** for radius, and **area** for area. To let the compiler know what **radius** and **area** are, specify their data types. That is the kind of the data stored in a variable, whether integer, *floating-point number*, or something else. This is known as *declaring variables*. Java provides simple data types for representing integers, floating-point numbers (i.e., numbers with a decimal point), characters, and Boolean types. These types are known as *primitive data types* or *fundamental types*.

Declare **radius** and **area** as double-precision floating-point numbers. The program can be expanded as follows:

```

public class ComputeArea {
    public static void main(String[] args) {
        double radius;
        double area;

        // Step 1: Read in radius

        // Step 2: Compute area

        // Step 3: Display the area
    }
}

```

The program declares **radius** and **area** as variables. The reserved word **double** indicates that **radius** and **area** are double-precision floating-point values stored in the computer.

The first step is to prompt the user to designate the circle's **radius**. You will learn how to prompt the user for information shortly. For now, to learn how variables work, you can assign a fixed value to **radius** in the program as you write the code; later, you'll modify the program to prompt the user for this value.

The second step is to compute **area** by assigning the result of the expression **radius * radius * 3.14159** to **area**.

In the final step, the program will display the value of **area** on the console by using the **System.out.println** method.

Listing 2.1 shows the complete program, and a sample run of the program is shown in Figure 2.1.

LISTING 2.1 ComputeArea.java

```

1 public class ComputeArea {
2     public static void main(String[] args) {
3         double radius; // Declare radius
4         double area; // Declare area
5
6         // Assign a radius
7         radius = 20; // radius is now 20

```

variable

descriptive names

data type

declare variables

floating-point number

primitive data types

```

8
9     // Compute area
10    area = radius * radius * 3.14159;
11
12    // Display results
13    System.out.println("The area for the circle of radius " +
14                        radius + " is " + area);
15 }
16 }

```

Compile → C:\book>javac ComputeArea.java

Run → C:\book>java ComputeArea
The area for the circle of radius 20.0 is 1256.636

C:\book>_

FIGURE 2.1 The program displays the area of a circle.

declare variable
assign value

tracing program

Variables such as **radius** and **area** correspond to memory locations. Every variable has a name, a type, a size, and a value. Line 3 declares that **radius** can store a **double** value. The value is not defined until you assign a value. Line 7 assigns **20** into variable **radius**. Similarly, line 4 declares variable **area**, and line 10 assigns a value into **area**. The following table shows the value in the memory for **area** and **radius** as the program is executed. Each row in the table shows the values of variables after the statement in the corresponding line in the program is executed. This method of reviewing how a program works is called *tracing a program*. Tracing programs are helpful for understanding how programs work, and they are useful tools for finding errors in programs.



line#	radius	area
3	no value	
4		no value
7	20	
10		1256.636

concatenate strings

concatenate strings with
numbers

The plus sign (+) has two meanings: one for addition and the other for concatenating (combining) strings. The plus sign (+) in lines 13–14 is called a *string concatenation operator*. It combines two strings into one. If a string is combined with a number, the number is converted into a string and concatenated with the other string. Therefore, the plus signs (+) in lines 13–14 concatenate strings into a longer string, which is then displayed in the output. Strings and string concatenation will be discussed further in Section 2.18.



Caution

A string cannot cross lines in the source code. Thus, the following statement would result in a compile error:

```
System.out.println("Introduction to Java Programming,  
by Y. Daniel Liang");
```


To fix the error, break the string into separate substrings, and use the concatenation operator (+) to combine them:

```
System.out.println("Introduction to Java Programming, " +
    "by Y. Daniel Liang");
```



Tip

This example consists of three steps. It is a good approach to develop and test these steps incrementally by adding them one at a time.

break a long string

incremental development and testing



MyProgrammingLab™

2.1 Identify and fix the errors in the following code:

```
1 public class Test {
2     public void main(string[] args) {
3         int i;
4         int k = 100.0;
5         int j = i + 1;
6
7         System.out.println("j is " + j + " and
8             k is " + k);
9     }
10 }
```

2.3 Reading Input from the Console

Reading input from the console enables the program to accept input from the user.

In Listing 2.1, the radius is fixed in the source code. To use a different radius, you have to modify the source code and recompile it. Obviously, this is not convenient, so instead you can use the **Scanner** class for console input.

Java uses **System.out** to refer to the standard output device and **System.in** to the standard input device. By default, the output device is the display monitor and the input device is the keyboard. To perform console output, you simply use the **println** method to display a primitive value or a string to the console. Console input is not directly supported in Java, but you can use the **Scanner** class to create an object to read input from **System.in**, as follows:

```
Scanner input = new Scanner(System.in);
```

The syntax **new Scanner(System.in)** creates an object of the **Scanner** type. The syntax **Scanner input** declares that **input** is a variable whose type is **Scanner**. The whole line **Scanner input = new Scanner(System.in)** creates a **Scanner** object and assigns its reference to the variable **input**. An object may invoke its methods. To invoke a method on an object is to ask the object to perform a task. You can invoke the methods listed in Table 2.1 to read various types of input.

For now, we will see how to read a number that includes a decimal point by invoking the **nextDouble()** method. Other methods will be covered when they are used. Listing 2.2 rewrites Listing 2.1 to prompt the user to enter a radius.

LISTING 2.2 ComputeAreaWithConsoleInput.java

```
1 import java.util.Scanner; // Scanner is in the java.util package
2
3 public class ComputeAreaWithConsoleInput {
4     public static void main(String[] args) {
5         // Create a Scanner object
6         Scanner input = new Scanner(System.in);
7     }
```

import class

create a Scanner



VideoNote
Obtain input

TABLE 2.1 Methods for **Scanner** Objects

<i>Method</i>	<i>Description</i>
<code>nextByte()</code>	reads an integer of the byte type.
<code>nextShort()</code>	reads an integer of the short type.
<code>nextInt()</code>	reads an integer of the int type.
<code>nextLong()</code>	reads an integer of the long type.
<code>nextFloat()</code>	reads a number of the float type.
<code>nextDouble()</code>	reads a number of the double type.
<code>next()</code>	reads a string that ends before a whitespace character.
<code>nextLine()</code>	reads a line of text (i.e., a string ending with the <i>Enter</i> key pressed).

```

8      // Prompt the user to enter a radius
9      System.out.print("Enter a number for radius: ");
10     double radius = input.nextDouble();
11
12     // Compute area
13     double area = radius * radius * 3.14159;
14
15     // Display results
16     System.out.println("The area for the circle of radius " +
17         radius + " is " + area);
18 }
19 }

```

read a double



```

Enter a number for radius: 2.5 ↵ Enter
The area for the circle of radius 2.5 is 19.6349375

```



```

Enter a number for radius: 23 ↵ Enter
The area for the circle of radius 23.0 is 1661.90111

```

The **Scanner** class is in the **java.util** package. It is imported in line 1. Line 6 creates a **Scanner** object.

The statement in line 9 displays a message to prompt the user for input.

```
System.out.print("Enter a number for radius: ");
```

print vs. println

The **print** method is identical to the **println** method except that **println** moves to the beginning of the next line after displaying the string, but **print** does not advance to the next line when completed.

The statement in line 10 reads input from the keyboard.

```
double radius = input.nextDouble();
```

After the user enters a number and presses the *Enter* key, the program reads the number and assigns it to **radius**.

More details on objects will be introduced in Chapter 8. For the time being, simply accept that this is how to obtain input from the console.

Listing 2.3 gives an example of reading multiple input from the keyboard. The program reads three numbers and displays their average.

LISTING 2.3 ComputeAverage.java

```

1  import java.util.Scanner; // Scanner is in the java.util package      import class
2
3  public class ComputeAverage {
4      public static void main(String[] args) {
5          // Create a Scanner object
6          Scanner input = new Scanner(System.in);                       create a Scanner
7
8          // Prompt the user to enter three numbers
9          System.out.print("Enter three numbers: ");
10         double number1 = input.nextDouble();                          read a double
11         double number2 = input.nextDouble();
12         double number3 = input.nextDouble();
13
14         // Compute average
15         double average = (number1 + number2 + number3) / 3;
16
17         // Display results
18         System.out.println("The average of " + number1 + " " + number2
19             + " " + number3 + " is " + average);
20     }
21 }
```

```

Enter three numbers: 1 2 3 ↵ Enter
The average of 1.0 2.0 3.0 is 2.0
```



enter input in one line

```

Enter three numbers: 10.5 ↵ Enter
11 ↵ Enter
11.5 ↵ Enter
The average of 10.5 11.0 11.5 is 11.0
```



enter input in multiple lines

The code for importing the **Scanner** class (line 1) and creating a **Scanner** object (line 6) are the same as in the preceding example as well as in all new programs you will write for reading input from the keyboard.

Line 9 prompts the user to enter three numbers. The numbers are read in lines 10–12. You may enter three numbers separated by spaces, then press the *Enter* key, or enter each number followed by a press of the *Enter* key, as shown in the sample runs of this program.

If you entered an input other than a numeric value, a runtime error would occur. In Chapter 14, you will learn how to handle the exception so that the program can continue to run.

runtime error



Note

Most of the programs in the early chapters of this book perform three steps: input, process, and output, called *IPO*. Input is receiving input from the user; process is producing results using the input; and output is displaying the results.

IPO



MyProgrammingLab™

2.2 How do you write a statement to let the user enter an integer or a double value from the keyboard?

2.3 What happens if you entered **5a** when executing the following code?
double radius = input.nextDouble();

2.4 Identifiers



Identifiers are the names that identify the elements such as classes, methods, and variables in a program.

As you see in Listing 2.3, **ComputeAverage**, **main**, **input**, **number1**, **number2**, **number3**, and so on are the names of things that appear in the program. In programming terminology, such names are called *identifiers*. All identifiers must obey the following rules:

- An identifier is a sequence of characters that consists of letters, digits, underscores (`_`), and dollar signs (`$`).
- An identifier must start with a letter, an underscore (`_`), or a dollar sign (`$`). It cannot start with a digit.
- An identifier cannot be a reserved word. (See Appendix A for a list of reserved words.)
- An identifier cannot be **true**, **false**, or **null**.
- An identifier can be of any length.

For example, **\$2**, **ComputeArea**, **area**, **radius**, and **showMessageDialog** are legal identifiers, whereas **2A** and **d+4** are not because they do not follow the rules. The Java compiler detects illegal identifiers and reports syntax errors.

identifiers

identifier naming rules

case sensitive



Note

Since Java is case sensitive, **area**, **Area**, and **AREA** are all different identifiers.

descriptive names



Tip

Identifiers are for naming variables, constants, methods, classes, and packages. Descriptive identifiers make programs easy to read. Avoid using abbreviations for identifiers. Using complete words is more descriptive. For example, **numberOfStudents** is better than **numStuds**, **numOfStuds**, or **numOfStudents**. We use descriptive names for complete programs in the text. However, we will occasionally use variables names such as **i**, **j**, **k**, **x**, and **y** in the code snippets for brevity. These names also provide a generic tone to the code snippets.

the \$ character



Tip

Do not name identifiers with the **\$** character. By convention, the **\$** character should be used only in mechanically generated source code.



MyProgrammingLab™

2.4 Which of the following identifiers are valid? Which are Java keywords?

miles, **Test**, **a++**, **--a**, **4#R**, **\$4**, **#44**, **apps**
class, **public**, **int**, **x**, **y**, **radius**

2.5 Variables



Variables are used to represent values that may be changed in the program.

why called variables?

As you see from the programs in the preceding sections, variables are used to store values to be used later in a program. They are called variables because their values can be changed. In

the program in Listing 2.2, **radius** and **area** are variables of the double-precision, floating-point type. You can assign any numerical value to **radius** and **area**, and the values of **radius** and **area** can be reassigned. For example, in the following code, **radius** is initially **1.0** (line 2) and then changed to **2.0** (line 7), and **area** is set to **3.14159** (line 3) and then reset to **12.56636** (line 8).

```

1 // Compute the first area
2 radius = 1.0;                                radius: 1.0
3 area = radius * radius * 3.14159;           area: 3.14159
4 System.out.println("The area is " + area + " for radius " + radius);
5
6 // Compute the second area
7 radius = 2.0;                                radius: 2.0
8 area = radius * radius * 3.14159;           area: 12.56636
9 System.out.println("The area is " + area + " for radius " + radius);

```

Variables are for representing data of a certain type. To use a variable, you declare it by telling the compiler its name as well as what type of data it can store. The *variable declaration* tells the compiler to allocate appropriate memory space for the variable based on its data type. The syntax for declaring a variable is

```
datatype variableName;
```

Here are some examples of variable declarations:

declare variable

```

int count;           // Declare count to be an integer variable
double radius;      // Declare radius to be a double variable
double interestRate; // Declare interestRate to be a double variable

```

These examples use the data types **int** and **double**. Later you will be introduced to additional data types, such as **byte**, **short**, **long**, **float**, **char**, and **boolean**.

If variables are of the same type, they can be declared together, as follows:

```
datatype variable1, variable2, ..., variablen;
```

The variables are separated by commas. For example,

```
int i, j, k; // Declare i, j, and k as int variables
```

Variables often have initial values. You can declare a variable and initialize it in one step. Consider, for instance, the following code:

initialize variables

```
int count = 1;
```

This is equivalent to the next two statements:

```

int count;
count = 1;

```

You can also use a shorthand form to declare and initialize variables of the same type together. For example,

```
int i = 1, j = 2;
```



Tip

A variable must be declared before it can be assigned a value. A variable declared in a method must be assigned a value before it can be used.

Whenever possible, declare a variable and assign its initial value in one step. This will make the program easy to read and avoid programming errors.

scope of a variable

Every variable has a scope. The *scope of a variable* is the part of the program where the variable can be referenced. The rules that define the scope of a variable will be introduced gradually later in the book. For now, all you need to know is that a variable must be declared and initialized before it can be used. Consider the following code:

```
int interestRate = 0.05
int interest = interestrate * 45
```

This code is wrong, because `interestRate` is assigned a value `0.05`, but `interestrate` has not been declared and initialized. Java is case sensitive, so it considers `interestRate` and `interestrate` to be two different variables.

2.6 Assignment Statements and Assignment Expressions



An assignment statement designates a value for a variable. An assignment statement can be used as an expression in Java.

assignment statement
assignment operator

After a variable is declared, you can assign a value to it by using an *assignment statement*. In Java, the equal sign (`=`) is used as the *assignment operator*. The syntax for assignment statements is as follows:

```
variable = expression;
```

expression

An *expression* represents a computation involving values, variables, and operators that, taking them together, evaluates to a value. For example, consider the following code:

```
int y = 1;           // Assign 1 to variable y
double radius = 1.0; // Assign 1.0 to variable radius
int x = 5 * (3 / 2); // Assign the value of the expression to x
x = y + 1;          // Assign the addition of y and 1 to x
area = radius * radius * 3.14159; // Compute area
```

You can use a variable in an expression. A variable can also be used in both sides of the `=` operator. For example,

```
x = x + 1;
```

In this assignment statement, the result of `x + 1` is assigned to `x`. If `x` is `1` before the statement is executed, then it becomes `2` after the statement is executed.

To assign a value to a variable, you must place the variable name to the left of the assignment operator. Thus, the following statement is wrong:

```
1 = x; // Wrong
```



Note

In mathematics, $x = 2 * x + 1$ denotes an equation. However, in Java, `x = 2 * x + 1` is an assignment statement that evaluates the expression `2 * x + 1` and assigns the result to `x`.

In Java, an assignment statement is essentially an expression that evaluates to the value to be assigned to the variable on the left side of the assignment operator. For this reason, an assignment statement is also known as an *assignment expression*. For example, the following statement is correct:

```
System.out.println(x = 1);
```

assignment expression

which is equivalent to

```
x = 1;
System.out.println(x);
```

If a value is assigned to multiple variables, you can use this syntax:

```
i = j = k = 1;
```

which is equivalent to

```
k = 1;
j = k;
i = j;
```



Note

In an assignment statement, the data type of the variable on the left must be compatible with the data type of the value on the right. For example, `int x = 1.0` would be illegal, because the data type of `x` is `int`. You cannot assign a `double` value (`1.0`) to an `int` variable without using type casting. Type casting is introduced in Section 2.15.

2.7 Named Constants

A named constant is an identifier that represents a permanent value.

The value of a variable may change during the execution of a program, but a *named constant*, or simply *constant*, represents permanent data that never changes. In our `ComputeArea` program, π is a constant. If you use it frequently, you don't want to keep typing `3.14159`; instead, you can declare a constant for π . Here is the syntax for declaring a constant:

```
final datatype CONSTANTNAME = value;
```

A constant must be declared and initialized in the same statement. The word `final` is a Java keyword for declaring a constant. For example, you can declare π as a constant and rewrite Listing 2.1 as follows:

```
// ComputeArea.java: Compute the area of a circle
public class ComputeArea {
    public static void main(String[] args) {
        final double PI = 3.14159; // Declare a constant

        // Assign a radius
        double radius = 20;

        // Compute area
        double area = radius * radius * PI;

        // Display results
        System.out.println("The area for the circle of radius " +
            radius + " is " + area);
    }
}
```

There are three benefits of using constants: (1) You don't have to repeatedly type the same value if it is used multiple times; (2) if you have to change the constant value (e.g., from `3.14` to `3.14159` for `PI`), you need to change it only in a single location in the source code; and (3) a descriptive name for a constant makes the program easy to read.



Key Point

constant

final keyword

benefits of constants

2.8 Naming Conventions



Sticking with the Java naming conventions makes your programs easy to read and avoids errors.

Make sure that you choose descriptive names with straightforward meanings for the variables, constants, classes, and methods in your program. As mentioned earlier, names are case sensitive. Listed below are the conventions for naming variables, methods, and classes.

- | | |
|----------------------------|--|
| name variables and methods | <ul style="list-style-type: none"> ■ Use lowercase for variables and methods. If a name consists of several words, concatenate them into one, making the first word lowercase and capitalizing the first letter of each subsequent word—for example, the variables <code>radius</code> and <code>area</code> and the method <code>showMessageDialog</code>. |
| name classes | <ul style="list-style-type: none"> ■ Capitalize the first letter of each word in a class name—for example, the class names <code>ComputeArea</code>, <code>System</code>, and <code>JOptionPane</code>. |
| name constants | <ul style="list-style-type: none"> ■ Capitalize every letter in a constant, and use underscores between words—for example, the constants <code>PI</code> and <code>MAX_VALUE</code>. |

It is important to follow the naming conventions to make your programs easy to read.



Caution

Do not choose class names that are already used in the Java library. For example, since the `System` class is defined in Java, you should not name your class `System`.

name classes



2.5 What are the benefits of using constants? Declare an `int` constant `SIZE` with value `20`.

2.6 What are the naming conventions for class names, method names, constants, and variables? Which of the following items can be a constant, a method, a variable, or a class according to the Java naming conventions?

`MAX_VALUE`, `Test`, `read`, `readInt`

2.7 Translate the following algorithm into Java code:

Step 1: Declare a `double` variable named `miles` with initial value `100`.

Step 2: Declare a `double` constant named `KILOMETERS_PER_MILE` with value `1.609`.

Step 3: Declare a `double` variable named `kilometers`, multiply `miles` and `KILOMETERS_PER_MILE`, and assign the result to `kilometers`.

Step 4: Display `kilometers` to the console.

What is kilometers after Step 4?

MyProgrammingLab™

2.9 Numeric Data Types and Operations



Java has six numeric types for integers and floating-point numbers with operators `+`, `-`, ``, `/`, and `%`.*

2.9.1 Numeric Types

Every data type has a range of values. The compiler allocates memory space for each variable or constant according to its data type. Java provides eight primitive data types for numeric values, characters, and Boolean values. This section introduces numeric data types and operators.

Table 2.2 lists the six numeric data types, their ranges, and their storage sizes.

TABLE 2.2 Numeric Data Types

Name	Range	Storage Size	
byte	-2^7 to 2^7-1 (-128 to 127)	8-bit signed	byte type
short	-2^{15} to $2^{15}-1$ (-32768 to 32767)	16-bit signed	short type
int	-2^{31} to $2^{31}-1$ (-2147483648 to 2147483647)	32-bit signed	int type
long	-2^{63} to $2^{63}-1$ (i.e., -9223372036854775808 to 9223372036854775807)	64-bit signed	long type
float	Negative range: $-3.4028235E+38$ to $-1.4E-45$ Positive range: $1.4E-45$ to $3.4028235E+38$	32-bit IEEE 754	float type
double	Negative range: $-1.7976931348623157E+308$ to $-4.9E-324$ Positive range: $4.9E-324$ to $1.7976931348623157E+308$	64-bit IEEE 754	double type

**Note**

IEEE 754 is a standard approved by the Institute of Electrical and Electronics Engineers for representing floating-point numbers on computers. The standard has been widely adopted. Java uses the 32-bit **IEEE 754** for the **float** type and the 64-bit **IEEE 754** for the **double** type. The **IEEE 754** standard also defines special floating-point values, which are listed in Appendix E.

Java uses four types for integers: **byte**, **short**, **int**, and **long**. Choose the type that is most appropriate for your variable. For example, if you know an integer stored in a variable is within a range of a byte, declare the variable as a **byte**. For simplicity and consistency, we will use **int** for integers most of the time in this book.

integer types

Java uses two types for floating-point numbers: **float** and **double**. The **double** type is twice as big as **float**, so the **double** is known as *double precision* and **float** as *single precision*. Normally you should use the **double** type, because it is more accurate than the **float** type.

floating-point types

**Caution**

When a variable is assigned a value that is too large (*in size*) to be stored, it causes *overflow*. For example, executing the following statement causes overflow, because the largest value that can be stored in a variable of the **int** type is **2147483647**. **2147483648** will be too large for an **int** value.

what is overflow?

```
int value = 2147483647 + 1;  
// value will actually be -2147483648
```

Likewise, executing the following statement causes overflow, because the smallest value that can be stored in a variable of the **int** type is **-2147483648**. **-2147483649** will be too large in size to be stored in an **int** variable.

```
int value = -2147483648 - 1;  
// value will actually be 2147483647
```

Java does not report warnings or errors on overflow, so be careful when working with numbers close to the maximum or minimum range of a given type.

what is underflow?

When a floating-point number is too small (i.e., too close to zero) to be stored, it causes *underflow*. Java approximates it to zero, so normally you don't need to be concerned about underflow.

2.9.2 Numeric Operators

operators +, -, *, /, %

The operators for numeric data types include the standard arithmetic operators: addition (+), subtraction (-), multiplication (*), division (/), and remainder (%), as shown in Table 2.3. The *operands* are the values operated by an operator.

operands

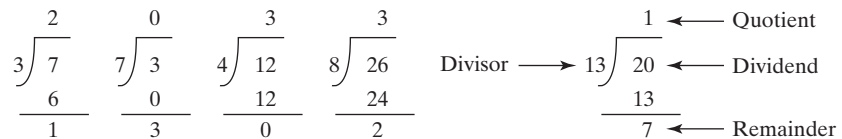
TABLE 2.3 Numeric Operators

Name	Meaning	Example	Result
+	Addition	34 + 1	35
-	Subtraction	34.0 - 0.1	33.9
*	Multiplication	300 * 30	9000
/	Division	1.0 / 2.0	0.5
%	Remainder	20 % 3	2

integer division

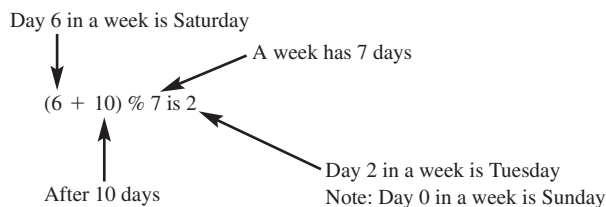
When both operands of a division are integers, the result of the division is an integer and the fractional part is truncated. For example, $5 / 2$ yields **2**, not **2.5**, and $-5 / 2$ yields **-2**, not **-2.5**. To perform regular mathematical division, one of the operands must be a floating-point number. For example, $5.0 / 2$ yields **2.5**.

The % operator, known as *remainder* or *modulo* operator, yields the remainder after division. The operand on the left is the dividend and the operand on the right is the divisor. Therefore, $7 \% 3$ yields **1**, $3 \% 7$ yields **3**, $12 \% 4$ yields **0**, $26 \% 8$ yields **2**, and $20 \% 13$ yields **7**.



The % operator is often used for positive integers, but it can also be used with negative integers and floating-point values. The remainder is negative only if the dividend is negative. For example, $-7 \% 3$ yields **-1**, $-12 \% 4$ yields **0**, $-26 \% -8$ yields **-2**, and $20 \% -13$ yields **7**.

Remainder is very useful in programming. For example, an even number % 2 is always 0 and an odd number % 2 is always 1. Thus, you can use this property to determine whether a number is even or odd. If today is Saturday, it will be Saturday again in 7 days. Suppose you and your friends are going to meet in 10 days. What day is in 10 days? You can find that the day is Tuesday using the following expression:



The program in Listing 2.4 obtains minutes and remaining seconds from an amount of time in seconds. For example, 500 seconds contains 8 minutes and 20 seconds.

LISTING 2.4 DisplayTime.java

```

1  import java.util.Scanner;           import Scanner
2
3  public class DisplayTime {
4      public static void main(String[] args) {
5          Scanner input = new Scanner(System.in);   create a Scanner
6          // Prompt the user for input
7          System.out.print("Enter an integer for seconds: ");
8          int seconds = input.nextInt();           read an integer
9
10         int minutes = seconds / 60; // Find minutes in seconds   divide
11         int remainingSeconds = seconds % 60; // Seconds remaining   remainder
12         System.out.println(seconds + " seconds is " + minutes +
13             " minutes and " + remainingSeconds + " seconds");
14     }
15 }
```

Enter an integer for seconds: 500
500 seconds is 8 minutes and 20 seconds



line#	seconds	minutes	remainingSeconds
8	500		
10		8	
11			20



The `nextInt()` method (line 8) reads an integer for **seconds**. Line 10 obtains the minutes using `seconds / 60`. Line 11 (`seconds % 60`) obtains the remaining seconds after taking away the minutes.

The `+` and `-` operators can be both unary and binary. A *unary* operator has only one operand; a *binary* operator has two. For example, the `-` operator in `-5` is a unary operator to negate number 5, whereas the `-` operator in `4 - 5` is a binary operator for subtracting 5 from 4.

unary operator
binary operator



Note

Calculations involving floating-point numbers are approximated because these numbers are not stored with complete accuracy. For example,

floating-point approximation

```
System.out.println(1.0 - 0.1 - 0.1 - 0.1 - 0.1 - 0.1);
```

displays 0.5000000000000001, not 0.5, and

```
System.out.println(1.0 - 0.9);
```

displays 0.09999999999999998, not 0.1. Integers are stored precisely. Therefore, calculations with integers yield a precise integer result.

2.9.3 Exponent Operations

`Math.pow(a, b)` method

The **Math.pow(a, b)** method can be used to compute a^b . The **pow** method is defined in the **Math** class in the Java API. You invoke the method using the syntax **Math.pow(a, b)** (i.e., **Math.pow(2, 3)**), which returns the result of a^b (2^3). Here **a** and **b** are parameters for the **pow** method and the numbers **2** and **3** are actual values used to invoke the method. For example,

```
System.out.println(Math.pow(2, 3)); // Displays 8.0
System.out.println(Math.pow(4, 0.5)); // Displays 2.0
System.out.println(Math.pow(2.5, 2)); // Displays 6.25
System.out.println(Math.pow(2.5, -2)); // Displays 0.16
```

Chapter 5 introduces more details on methods. For now, all you need to know is how to invoke the **pow** method to perform the exponent operation.



MyProgrammingLab™

2.8 Find the largest and smallest **byte**, **short**, **int**, **long**, **float**, and **double**. Which of these data types requires the least amount of memory?

2.9 Show the result of the following remainders.

```
56 % 6
78 % -4
-34 % 5
-34 % -5
5 % 1
1 % 5
```

2.10 If today is Tuesday, what will be the day in 100 days?

2.11 What is the result of **25 / 4**? How would you rewrite the expression if you wished the result to be a floating-point number?

2.12 Are the following statements correct? If so, show the output.

```
System.out.println("25 / 4 is " + 25 / 4);
System.out.println("25 / 4.0 is " + 25 / 4.0);
System.out.println("3 * 2 / 4 is " + 3 * 2 / 4);
System.out.println("3.0 * 2 / 4 is " + 3.0 * 2 / 4);
```

2.13 Write a statement to display the result of $2^{3.5}$.

2.14 Suppose **m** and **r** are integers. Write a Java expression for mr^2 to obtain a floating-point result.

2.10 Numeric Literals



A *literal* is a constant value that appears directly in a program.

literal

For example, **34** and **0.305** are literals in the following statements:

```
int numberOfYears = 34;
double weight = 0.305;
```

2.10.1 Integer Literals

An integer literal can be assigned to an integer variable as long as it can fit into the variable. A compile error will occur if the literal is too large for the variable to hold. The statement **byte b = 128**, for example, will cause a compile error, because **128** cannot be stored in a variable of the **byte** type. (Note that the range for a byte value is from **-128** to **127**.)

An integer literal is assumed to be of the `int` type, whose value is between -2^{31} (-2147483648) and $2^{31} - 1$ (2147483647). To denote an integer literal of the `long` type, append the letter `L` or `l` to it. For example, to write integer `2147483648` in a Java program, you have to write it as `2147483648L` or `2147483648l`, because `2147483648` exceeds the range for the `int` value. `L` is preferred because `l` (lowercase `L`) can easily be confused with `1` (the digit one).

long type

**Note**

By default, an integer literal is a decimal integer number. To denote an octal integer literal, use a leading `0` (zero), and to denote a hexadecimal integer literal, use a leading `0x` or `0X` (zero x). For example, the following code displays the decimal value `65535` for hexadecimal number `FFFF`.

```
System.out.println(0xFFFF);
```

Hexadecimal numbers, binary numbers, and octal numbers are introduced in Appendix F.

octal and hex literals

2.10.2 Floating-Point Literals

Floating-point literals are written with a decimal point. By default, a floating-point literal is treated as a `double` type value. For example, `5.0` is considered a `double` value, not a `float` value. You can make a number a `float` by appending the letter `f` or `F`, and you can make a number a `double` by appending the letter `d` or `D`. For example, you can use `100.2f` or `100.2F` for a `float` number, and `100.2d` or `100.2D` for a `double` number.

suffix `f` or `F`
suffix `d` or `D`

**Note**

The `double` type values are more accurate than the `float` type values. For example,

```
System.out.println("1.0 / 3.0 is " + 1.0 / 3.0);
```

displays `1.0 / 3.0 is 0.3333333333333333`.

```
System.out.println("1.0F / 3.0F is " + 1.0F / 3.0F);
```

displays `1.0F / 3.0F is 0.33333334`.

double vs. float

2.10.3 Scientific Notation

Floating-point literals can be written in scientific notation in the form of $a \times 10^b$. For example, the scientific notation for `123.456` is 1.23456×10^2 and for `0.0123456` is 1.23456×10^{-2} . A special syntax is used to write scientific notation numbers. For example, 1.23456×10^2 is written as `1.23456E2` or `1.23456E+2` and 1.23456×10^{-2} as `1.23456E-2`. `E` (or `e`) represents an exponent and can be in either lowercase or uppercase.

**Note**

The `float` and `double` types are used to represent numbers with a decimal point. Why are they called *floating-point numbers*? These numbers are stored in scientific notation internally. When a number such as `50.534` is converted into scientific notation, such as `5.0534E+1`, its decimal point is moved (i.e., floated) to a new position.

why called floating-point?

2.15 Which of the following are correct literals for floating-point numbers?

`12.3`, `12.3e+2`, `23.4e-2`, `-334.4`, `20.5`, `39F`, `40D`

2.16 Which of the following are the same as `52.534`?

`5.2534e+1`, `0.52534e+2`, `525.34e-1`, `5.2534e+0`



MyProgrammingLab™

2.1.1 Evaluating Expressions and Operator Precedence



Java expressions are evaluated in the same way as arithmetic expressions.

Writing a numeric expression in Java involves a straightforward translation of an arithmetic expression using Java operators. For example, the arithmetic expression

$$\frac{3 + 4x}{5} - \frac{10(y - 5)(a + b + c)}{x} + 9\left(\frac{4}{x} + \frac{9 + x}{y}\right)$$

can be translated into a Java expression as:

$$(3 + 4 * x) / 5 - 10 * (y - 5) * (a + b + c) / x + 9 * (4 / x + (9 + x) / y)$$

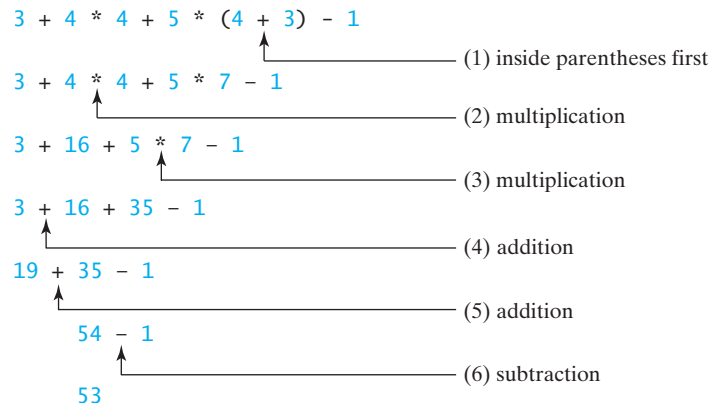
evaluating an expression

Though Java has its own way to evaluate an expression behind the scene, the result of a Java expression and its corresponding arithmetic expression are the same. Therefore, you can safely apply the arithmetic rule for evaluating a Java expression. Operators contained within pairs of parentheses are evaluated first. Parentheses can be nested, in which case the expression in the inner parentheses is evaluated first. When more than one operator is used in an expression, the following operator precedence rule is used to determine the order of evaluation.

operator precedence rule

- Multiplication, division, and remainder operators are applied first. If an expression contains several multiplication, division, and remainder operators, they are applied from left to right.
- Addition and subtraction operators are applied last. If an expression contains several addition and subtraction operators, they are applied from left to right.

Here is an example of how an expression is evaluated:



Listing 2.5 gives a program that converts a Fahrenheit degree to Celsius using the formula $celsius = \frac{5}{9}(fahrenheit - 32)$.

LISTING 2.5 FahrenheitToCelsius.java

```

1  import java.util.Scanner;
2
3  public class FahrenheitToCelsius {
4      public static void main(String[] args) {
5          Scanner input = new Scanner(System.in);
6
7          System.out.print("Enter a degree in Fahrenheit: ");
    
```

```

8     double fahrenheit = input.nextDouble();
9
10    // Convert Fahrenheit to Celsius
11    double celsius = (5.0 / 9) * (fahrenheit - 32);
12    System.out.println("Fahrenheit " + fahrenheit + " is " +
13                       celsius + " in Celsius");
14 }
15 }

```

divide

Enter a degree in Fahrenheit: 100
 Fahrenheit 100.0 is 37.77777777777778 in Celsius



line#	fahrenheit	celsius
8	100	
11		37.77777777777778



Be careful when applying division. Division of two integers yields an integer in Java. $\frac{5}{9}$ is translated to `5.0 / 9` instead of `5 / 9` in line 11, because `5 / 9` yields `0` in Java.

integer vs. decimal division

2.17 How would you write the following arithmetic expression in Java?

$$\frac{4}{3(r + 34)} - 9(a + bc) + \frac{3 + d(2 + a)}{a + bd}$$



MyProgrammingLab™

2.12 Case Study: Displaying the Current Time

You can invoke `System.currentTimeMillis()` to return the current time.

The problem is to develop a program that displays the current time in GMT (Greenwich Mean Time) in the format hour:minute:second, such as 13:19:8.

The `currentTimeMillis` method in the `System` class returns the current time in milliseconds elapsed since the time `00:00:00` on January 1, 1970 GMT, as shown in Figure 2.2. This time is known as the *UNIX epoch*. The epoch is the point when time starts, and `1970` was the year when the UNIX operating system was formally introduced.



VideoNote

Use operators / and %

`currentTimeMillis`

UNIX epoch

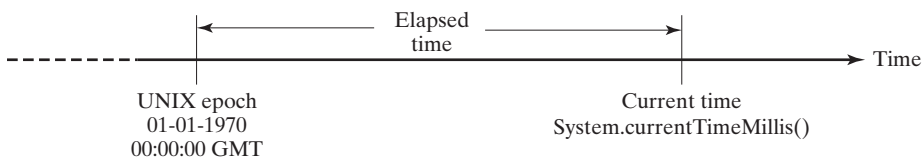


FIGURE 2.2 The `System.currentTimeMillis()` returns the number of milliseconds since the UNIX epoch.

You can use this method to obtain the current time, and then compute the current second, minute, and hour as follows.

1. Obtain the total milliseconds since midnight, January 1, 1970, in `totalMilliseconds` by invoking `System.currentTimeMillis()` (e.g., `1203183068328` milliseconds).

2. Obtain the total seconds `totalSeconds` by dividing `totalMilliseconds` by `1000` (e.g., `1203183068328` milliseconds / `1000` = `1203183068` seconds).
3. Compute the current second from `totalSeconds % 60` (e.g., `1203183068` seconds % `60` = `8`, which is the current second).
4. Obtain the total minutes `totalMinutes` by dividing `totalSeconds` by `60` (e.g., `1203183068` seconds / `60` = `20053051` minutes).
5. Compute the current minute from `totalMinutes % 60` (e.g., `20053051` minutes % `60` = `31`, which is the current minute).
6. Obtain the total hours `totalHours` by dividing `totalMinutes` by `60` (e.g., `20053051` minutes / `60` = `334217` hours).
7. Compute the current hour from `totalHours % 24` (e.g., `334217` hours % `24` = `17`, which is the current hour).

Listing 2.6 gives the complete program.

LISTING 2.6 ShowCurrentTime.java

```

1  public class ShowCurrentTime {
2      public static void main(String[] args) {
3          // Obtain the total milliseconds since midnight, Jan 1, 1970
4          long totalMilliseconds = System.currentTimeMillis();
5
6          // Obtain the total seconds since midnight, Jan 1, 1970
7          long totalSeconds = totalMilliseconds / 1000;
8
9          // Compute the current second in the minute in the hour
10         long currentSecond = totalSeconds % 60;
11
12         // Obtain the total minutes
13         long totalMinutes = totalSeconds / 60;
14
15         // Compute the current minute in the hour
16         long currentMinute = totalMinutes % 60;
17
18         // Obtain the total hours
19         long totalHours = totalMinutes / 60;
20
21         // Compute the current hour
22         long currentHour = totalHours % 24;
23
24         // Display results
25         System.out.println("Current time is " + currentHour + ":"
26             + currentMinute + ":" + currentSecond + " GMT");
27     }
28 }

```



Current time is 17:31:8 GMT

Line 4 invokes `System.currentTimeMillis()` to obtain the current time in milliseconds as a long value. Thus, all the variables are declared as the long type in this program. The seconds, minutes, and hours are extracted from the current time using the `/` and `%` operators (lines 6–22).

line#	4	7	10	13	16	19	22
variables							
totalMilliseconds	1203183068328						
totalSeconds		1203183068					
currentSecond			8				
totalMinutes				20053051			
currentMinute					31		
totalHours						334217	
currentHour							17



In the sample run, a single digit **8** is displayed for the second. The desirable output would be **08**. This can be fixed by using a function that formats a single digit with a prefix **0** (see Exercise 5.37).

2.13 Augmented Assignment Operators

The operators **+**, **-**, *****, **/**, and **%** can be combined with the assignment operator to form augmented operators.



Very often the current value of a variable is used, modified, and then reassigned back to the same variable. For example, the following statement increases the variable **count** by **1**:

```
count = count + 1;
```

Java allows you to combine assignment and addition operators using an augmented (or compound) assignment operator. For example, the preceding statement can be written as:

```
count += 1;
```

The **+=** is called the *addition assignment operator*. Table 2.4 shows other augmented assignment operators.

TABLE 2.4 Augmented Assignment Operators

Operator	Name	Example	Equivalent
+=	Addition assignment	i += 8	i = i + 8
-=	Subtraction assignment	i -= 8	i = i - 8
*=	Multiplication assignment	i *= 8	i = i * 8
/=	Division assignment	i /= 8	i = i / 8
%=	Remainder assignment	i %= 8	i = i % 8

**Caution**

There are no spaces in the augmented assignment operators. For example, `+ =` should be `+=`.

**Note**

Like the assignment operator (`=`), the operators (`+=`, `--`, `*=`, `/=`, `%=`) can be used to form an assignment statement as well as an expression. For example, in the following code, `x += 2` is a statement in the first line and an expression in the second line.

```
x += 2; // Statement
System.out.println(x += 2); // Expression
```

2.14 Increment and Decrement Operators

**Key Point**

The increment (`++`) and decrement (`--`) operators are for incrementing and decrementing a variable by 1.

increment operator (`++`)
decrement operator (`--`)

The `++` and `--` are two shorthand operators for incrementing and decrementing a variable by **1**. These are handy, because that's often how much the value needs to be changed in many programming tasks. For example, the following code increments **i** by **1** and decrements **j** by **1**.

```
int i = 3, j = 3;
i++; // i becomes 4
j--; // j becomes 2
```

postincrement
postdecrement

`i++` is pronounced as **i** plus plus and `i--` as **i** minus minus. These operators are known as *postfix increment* (or postincrement) and *postfix decrement* (or postdecrement), because the operators `++` and `--` are placed after the variable. These operators can also be placed before the variable. For example,

```
int i = 3, j = 3;
++i; // i becomes 4
--j; // j becomes 2
```

preincrement
predecrement

`++i` increments **i** by **1** and `--j` decrements **j** by **1**. These operators are known as *prefix increment* (or preincrement) and *prefix decrement* (or predecrement).

As you see, the effect of `i++` and `++i` or `i--` and `--i` are the same in the preceding examples. However, their effects are different when they are used in statements that do more than just increment and decrement. Table 2.5 describes their differences and gives examples.

TABLE 2.5 Increment and Decrement Operators

Operator	Name	Description	Example (assume $i = 1$)
<code>++var</code>	preincrement	Increment var by 1 , and use the new var value in the statement	<code>int j = ++i;</code> // j is 2, i is 2
<code>var++</code>	postincrement	Increment var by 1 , but use the original var value in the statement	<code>int j = i++;</code> // j is 1, i is 2
<code>--var</code>	predecrement	Decrement var by 1 , and use the new var value in the statement	<code>int j = --i;</code> // j is 0, i is 0
<code>var--</code>	postdecrement	Decrement var by 1 , and use the original var value in the statement	<code>int j = i--;</code> // j is 1, i is 0

Here are additional examples to illustrate the differences between the prefix form of `++` (or `--`) and the postfix form of `++` (or `--`). Consider the following code:

```
int i = 10;
int newNum = 10 * i++;
```

Same effect as

```
int newNum = 10 * i;
i = i + 1;
```

```
System.out.print("i is " + i
+ ", newNum is " + newNum);
```

```
i is 11, newNum is 100
```



In this case, `i` is incremented by `1`, then the *old* value of `i` is used in the multiplication. So `newNum` becomes `100`. If `i++` is replaced by `++i` as follows,

```
int i = 10;
int newNum = 10 * (++i);
```

Same effect as

```
i = i + 1;
int newNum = 10 * i;
```

```
System.out.print("i is " + i
+ ", newNum is " + newNum);
```

```
i is 11, newNum is 110
```



`i` is incremented by `1`, and the new value of `i` is used in the multiplication. Thus `newNum` becomes `110`.

Here is another example:

```
double x = 1.0;
double y = 5.0;
double z = x-- + (++y);
```

After all three lines are executed, `y` becomes `6.0`, `z` becomes `7.0`, and `x` becomes `0.0`.



Tip

Using increment and decrement operators makes expressions short, but it also makes them complex and difficult to read. Avoid using these operators in expressions that modify multiple variables or the same variable multiple times, such as this one: `int k = ++i + i`.

2.18 Which of these statements are true?

- Any expression can be used as a statement.
- The expression `x++` can be used as a statement.
- The statement `x = x + 5` is also an expression.
- The statement `x = y = x = 0` is illegal.

2.19 Assume that `int a = 1` and `double d = 1.0`, and that each expression is independent. What are the results of the following expressions?

```
a = 46 / 9;
a = 46 % 9 + 4 * 4 - 2;
a = 45 + 43 % 5 * (23 * 3 % 2);
a %= 3 / a + 3;
d = 4 + d * d + 4;
d += 1.5 * 3 + (++a);
d -= 1.5 * 3 + a++;
```



Check
Point
MyProgrammingLab™

- 2.20** How do you obtain the current minute using the `System.currentTimeMillis()` method?

2.15 Numeric Type Conversions



Floating-point numbers can be converted into integers using explicit casting.

Can you perform binary operations with two operands of different types? Yes. If an integer and a floating-point number are involved in a binary operation, Java automatically converts the integer to a floating-point value. So, `3 * 4.5` is same as `3.0 * 4.5`.

You can always assign a value to a numeric variable whose type supports a larger range of values; thus, for instance, you can assign a `long` value to a `float` variable. You cannot, however, assign a value to a variable of a type with a smaller range unless you use *type casting*. *Casting* is an operation that converts a value of one data type into a value of another data type. Casting a type with a small range to a type with a larger range is known as *widening a type*. Casting a type with a large range to a type with a smaller range is known as *narrowing a type*. Java will automatically widen a type, but you must narrow a type explicitly.

The syntax for casting a type is to specify the target type in parentheses, followed by the variable's name or the value to be cast. For example, the following statement

```
System.out.println((int)1.7);
```

displays `1`. When a `double` value is cast into an `int` value, the fractional part is truncated.

The following statement

```
System.out.println((double)1 / 2);
```

displays `0.5`, because `1` is cast to `1.0` first, then `1.0` is divided by `2`. However, the statement

```
System.out.println(1 / 2);
```

displays `0`, because `1` and `2` are both integers and the resulting value should also be an integer.

casting
widening a type
narrowing a type

possible loss of precision



Caution

Casting is necessary if you are assigning a value to a variable of a smaller type range, such as assigning a `double` value to an `int` variable. A compile error will occur if casting is not used in situations of this kind. However, be careful when using casting, as loss of information might lead to inaccurate results.



Note

Casting does not change the variable being cast. For example, `d` is not changed after casting in the following code:

```
double d = 4.5;
int i = (int)d; // i becomes 4, but d is still 4.5
```



Note

In Java, an augmented expression of the form `x1 op= x2` is implemented as `x1 = (T)(x1 op x2)`, where `T` is the type for `x1`. Therefore, the following code is correct.

```
int sum = 0;
sum += 4.5; // sum becomes 4 after this statement
```

`sum += 4.5` is equivalent to `sum = (int)(sum + 4.5)`.

casting in an augmented
expression

**Note**

To assign a variable of the **int** type to a variable of the **short** or **byte** type, explicit casting must be used. For example, the following statements have a compile error:

```
int i = 1;
byte b = i; // Error because explicit casting is required
```

However, so long as the integer literal is within the permissible range of the target variable, explicit casting is not needed to assign an integer literal to a variable of the **short** or **byte** type (see Section 2.10, Numeric Literals).

The program in Listing 2.7 displays the sales tax with two digits after the decimal point.

LISTING 2.7 SalesTax.java

```
1  import java.util.Scanner;
2
3  public class SalesTax {
4      public static void main(String[] args) {
5          Scanner input = new Scanner(System.in);
6
7          System.out.print("Enter purchase amount: ");
8          double purchaseAmount = input.nextDouble();
9
10         double tax = purchaseAmount * 0.06;
11         System.out.println("Sales tax is $" + (int)(tax * 100) / 100.0);
12     }
13 }
```

casting

Enter purchase amount: 197.55
Sales tax is \$11.85



line#	purchaseAmount	tax	output
8	197.55		
10		11.853	
11			11.85



The variable **purchaseAmount** is **197.55** (line 8). The sales tax is **6%** of the purchase, so the **tax** is evaluated as **11.853** (line 10). Note that

formatting numbers

```
tax * 100 is 1185.3
(int)(tax * 100) is 1185
(int)(tax * 100) / 100.0 is 11.85
```

So, the statement in line 11 displays the tax **11.85** with two digits after the decimal point.

- 2.21** Can different types of numeric values be used together in a computation?
- 2.22** What does an explicit casting from a **double** to an **int** do with the fractional part of the **double** value? Does casting change the variable being cast?
- 2.23** Show the following output:

```
float f = 12.5F;
int i = (int)f;
```



Check
Point
MyProgrammingLab™

```
System.out.println("f is " + f);
System.out.println("i is " + i);
```

- 2.24** If you change `(int)(tax * 100) / 100.0` to `(int)(tax * 100) / 100` in line 11 in Listing 2.7, what will be the output for the input purchase amount of **197.556**?

2.16 Software Development Process



The software development life cycle is a multi-stage process that includes requirements specification, analysis, design, implementation, testing, deployment, and maintenance.



VideoNote

Software development process

Developing a software product is an engineering process. Software products, no matter how large or how small, have the same life cycle: requirements specification, analysis, design, implementation, testing, deployment, and maintenance, as shown in Figure 2.3.

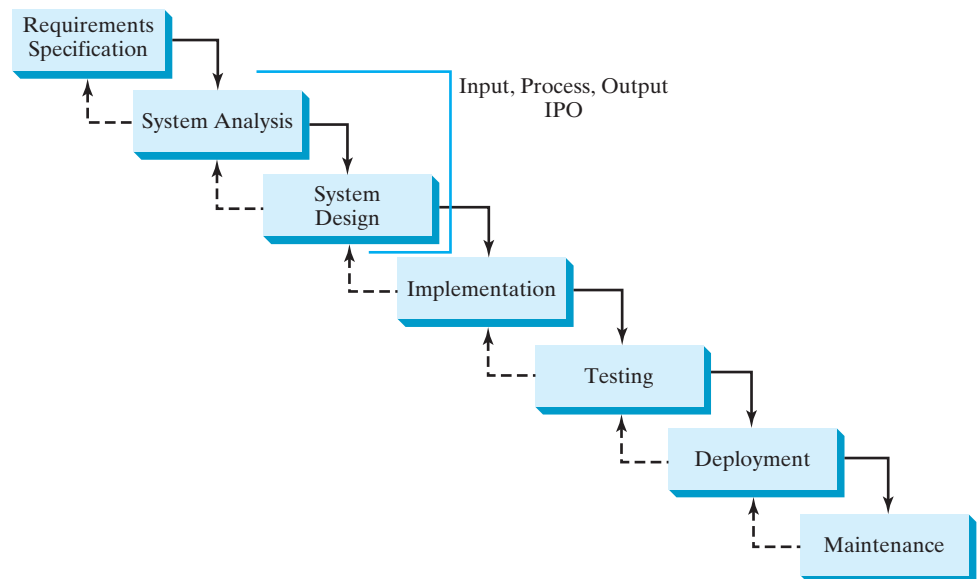


FIGURE 2.3 At any stage of the software development life cycle, it may be necessary to go back to a previous stage to correct errors or deal with other issues that might prevent the software from functioning as expected.

requirements specification

Requirements specification is a formal process that seeks to understand the problem that the software will address and to document in detail what the software system needs to do. This phase involves close interaction between users and developers. Most of the examples in this book are simple, and their requirements are clearly stated. In the real world, however, problems are not always well defined. Developers need to work closely with their customers (the individuals or organizations that will use the software) and study the problem carefully to identify what the software needs to do.

system analysis

System analysis seeks to analyze the data flow and to identify the system's input and output. When you do analysis, it helps to identify what the output is first, and then figure out what input data you need in order to produce the output.

system design

System design is to design a process for obtaining the output from the input. This phase involves the use of many levels of abstraction to break down the problem into manageable components and design strategies for implementing each component. You can view each component as a subsystem that performs a specific function of the system. The essence of system analysis and design is input, process, and output (IPO).

IPO

Implementation involves translating the system design into programs. Separate programs are written for each component and then integrated to work together. This phase requires the use of a programming language such as Java. The implementation involves coding, self-testing, and debugging (that is, finding errors, called *bugs*, in the code). implementation

Testing ensures that the code meets the requirements specification and weeds out bugs. An independent team of software engineers not involved in the design and implementation of the product usually conducts such testing. testing

Deployment makes the software available for use. Depending on the type of the software, it may be installed on each user's machine or installed on a server accessible on the Internet. deployment

Maintenance is concerned with updating and improving the product. A software product must continue to perform and improve in an ever-evolving environment. This requires periodic upgrades of the product to fix newly discovered bugs and incorporate changes. maintenance

To see the software development process in action, we will now create a program that computes loan payments. The loan can be a car loan, a student loan, or a home mortgage loan. For an introductory programming course, we focus on requirements specification, analysis, design, implementation, and testing.



VideoNote

Compute loan payments

Stage 1: Requirements Specification

The program must satisfy the following requirements:

- It must let the user enter the interest rate, the loan amount, and the number of years for which payments will be made.
- It must compute and display the monthly payment and total payment amounts.

Stage 2: System Analysis

The output is the monthly payment and total payment, which can be obtained using the following formulas:

$$\text{monthlyPayment} = \frac{\text{loanAmount} \times \text{monthlyInterestRate}}{1 - \frac{1}{(1 + \text{monthlyInterestRate})^{\text{numberOfYears} \times 12}}}$$

$$\text{totalPayment} = \text{monthlyPayment} \times \text{numberOfYears} \times 12$$

So, the input needed for the program is the monthly interest rate, the length of the loan in years, and the loan amount.



Note

The requirements specification says that the user must enter the annual interest rate, the loan amount, and the number of years for which payments will be made. During analysis, however, it is possible that you may discover that input is not sufficient or that some values are unnecessary for the output. If this happens, you can go back and modify the requirements specification.



Note

In the real world, you will work with customers from all walks of life. You may develop software for chemists, physicists, engineers, economists, and psychologists, and of course you will not have (or need) complete knowledge of all these fields. Therefore, you don't have to know how formulas are derived, but given the monthly interest rate, the number of years, and the loan amount, you can compute the monthly payment in this program. You will, however, need to communicate with customers and understand how a mathematical model works for the system.

Stage 3: System Design

During system design, you identify the steps in the program.

- Step 1. Prompt the user to enter the annual interest rate, the number of years, and the loan amount.
- Step 2. The input for the annual interest rate is a number in percent format, such as 4.5%. The program needs to convert it into a decimal by dividing it by **100**. To obtain the monthly interest rate from the annual interest rate, divide it by **12**, since a year has 12 months. So, to obtain the monthly interest rate in decimal format, you need to divide the annual interest rate in percentage by **1200**. For example, if the annual interest rate is 4.5%, then the monthly interest rate is $4.5/1200 = 0.00375$.
- Step 3. Compute the monthly payment using the preceding formula.
- Step 4. Compute the total payment, which is the monthly payment multiplied by **12** and multiplied by the number of years.
- Step 5. Display the monthly payment and total payment.

Stage 4: Implementation

Math.pow(a, b) method

Implementation is also known as *coding* (writing the code). In the formula, you have to compute $(1 + \text{monthlyInterestRate})^{\text{numberOfYears} \times 12}$, which can be obtained using **Math.pow(1 + monthlyInterestRate, numberOfYears * 12)**.

Listing 2.8 gives the complete program.

LISTING 2.8 ComputeLoan.java

```

import class
1  import java.util.Scanner;
2
3  public class ComputeLoan {
4      public static void main(String[] args) {
5          // Create a Scanner
create a Scanner
6          Scanner input = new Scanner(System.in);
7
8          // Enter annual interest rate in percentage, e.g., 7.25%
enter interest rate
9          System.out.print("Enter annual interest rate, e.g., 7.25%: ");
10         double annualInterestRate = input.nextDouble();
11
12         // Obtain monthly interest rate
13         double monthlyInterestRate = annualInterestRate / 1200;
14
15         // Enter number of years
enter years
16         System.out.print(
17             "Enter number of years as an integer, e.g., 5: ");
18         int numberOfYears = input.nextInt();
19
20         // Enter loan amount
enter loan amount
21         System.out.print("Enter loan amount, e.g., 120000.95: ");
22         double loanAmount = input.nextDouble();
23
24         // Calculate payment
monthlyPayment
25         double monthlyPayment = loanAmount * monthlyInterestRate / (1
26             - 1 / Math.pow(1 + monthlyInterestRate, numberOfYears * 12));
totalPayment
27         double totalPayment = monthlyPayment * numberOfYears * 12;
28
29         // Display results

```



```

30     System.out.println("The monthly payment is $" +
31         (int)(monthlyPayment * 100) / 100.0);           casting
32     System.out.println("The total payment is $" +
33         (int)(totalPayment * 100) / 100.0);           casting
34 }
35 }

```

```

Enter annual interest rate, e.g., 5.75%: 5.75 
Enter number of years as an integer, e.g., 5: 15 
Enter loan amount, e.g., 120000.95: 250000 
The monthly payment is $2076.02
The total payment is $373684.53

```



	line#	10	13	18	22	25	27
variables							
annualInterestRate		5.75					
monthlyInterestRate			0.004791666666				
numberOfYears				15			
loanAmount					250000		
monthlyPayment						2076.0252175	
totalPayment							373684.539



Line 10 reads the annual interest rate, which is converted into the monthly interest rate in line 13.

Choose the most appropriate data type for the variable. For example, `numberOfYears` is best declared as an `int` (line 18), although it could be declared as a `long`, `float`, or `double`. Note that `byte` might be the most appropriate for `numberOfYears`. For simplicity, however, the examples in this book will use `int` for integer and `double` for floating-point values.

The formula for computing the monthly payment is translated into Java code in lines 25–27.

Casting is used in lines 31 and 33 to obtain a new `monthlyPayment` and `totalPayment` with two digits after the decimal points.

The program uses the `Scanner` class, imported in line 1. The program also uses the `Math` class, and you might be wondering why that class isn't imported into the program. The `Math` class is in the `java.lang` package, and all classes in the `java.lang` package are implicitly imported. Therefore, you don't need to explicitly import the `Math` class.

`java.lang` package

Stage 5: Testing

After the program is implemented, test it with some sample input data and verify whether the output is correct. Some of the problems may involve many cases, as you will see in later chapters. For these types of problems, you need to design test data that cover all cases.



Tip

The system design phase in this example identified several steps. It is a good approach to developing and testing these steps incrementally by adding them one at a time. This approach makes it much easier to pinpoint problems and debug the program.

incremental development and testing



2.25 How would you write the following arithmetic expression?

$$\frac{-b + \sqrt{b^2 - 4ac}}{2a}$$

MyProgrammingLab™

2.17 Character Data Type and Operations



A character data type represents a single character.

char type

In addition to processing numeric values, you can process characters in Java. The character data type, **char**, is used to represent a single character. A character literal is enclosed in single quotation marks. Consider the following code:

```
char letter = 'A';
char numChar = '4';
```

The first statement assigns character **A** to the **char** variable **letter**. The second statement assigns digit character **4** to the **char** variable **numChar**.

char literal



Caution

A string literal must be enclosed in quotation marks (" "). A character literal is a single character enclosed in single quotation marks (' '). Therefore, "A" is a string, but 'A' is a character.

2.17.1 Unicode and ASCII code

encoding

Computers use binary numbers internally. A character is stored in a computer as a sequence of 0s and 1s. Mapping a character to its binary representation is called *encoding*. There are different ways to encode a character. How characters are encoded is defined by an *encoding scheme*.

Unicode

Java supports *Unicode*, an encoding scheme established by the Unicode Consortium to support the interchange, processing, and display of written texts in the world's diverse languages. Unicode was originally designed as a 16-bit character encoding. The primitive data type **char** was intended to take advantage of this design by providing a simple data type that could hold any character. However, it turned out that the 65,536 characters possible in a 16-bit encoding are not sufficient to represent all the characters in the world. The Unicode standard therefore has been extended to allow up to 1,112,064 characters. Those characters that go beyond the original 16-bit limit are called *supplementary characters*. Java supports the supplementary characters. The processing and representing of supplementary characters are beyond the scope of this book. For simplicity, this book considers only the original 16-bit Unicode characters. These characters can be stored in a **char** type variable.

original Unicode

A 16-bit Unicode takes two bytes, preceded by **\u**, expressed in four hexadecimal digits that run from **\u0000** to **\uFFFF**. Hexadecimal numbers are introduced in Appendix F, Number Systems. For example, the English word **welcome** is translated into Chinese using two characters, 欢迎. The Unicodes of these two characters are **\u6B22\u8FCE**.

supplementary Unicode

Listing 2.9 gives a program that displays two Chinese characters and three Greek letters.

LISTING 2.9 DisplayUnicode.java

```
1 import javax.swing.JOptionPane;
2
3 public class DisplayUnicode {
4     public static void main(String[] args) {
5         JOptionPane.showMessageDialog(null,
6             "\u6B22\u8FCE \u03b1 \u03b2 \u03b3",
7             "\u6B22\u8FCE Welcome",
```



```

8     JOptionPane.INFORMATION_MESSAGE);
9 }
10 }

```

If no Chinese font is installed on your system, you will not be able to see the Chinese characters. The Unicodes for the Greek letters α β γ are `\u03b1` `\u03b2` `\u03b3`.

Most computers use *ASCII* (*American Standard Code for Information Interchange*), a 7-bit encoding scheme for representing all uppercase and lowercase letters, digits, punctuation marks, and control characters. Unicode includes ASCII code, with `\u0000` to `\u007F` corresponding to the 128 ASCII characters. (See Appendix B for a list of ASCII characters and their decimal and hexadecimal codes.) You can use ASCII characters such as `'X'`, `'1'`, and `'$'` in a Java program as well as Unicodes. Thus, for example, the following statements are equivalent:

```

char letter = 'A';
char letter = '\u0041'; // Character A's Unicode is 0041

```

Both statements assign character **A** to the `char` variable `letter`.



Note

The increment and decrement operators can also be used on `char` variables to get the next or preceding Unicode character. For example, the following statements display character `b`.

```

char ch = 'a';
System.out.println(++ch);

```

`char` increment and decrement

2.17.2 Escape Characters

Suppose you want to print a message with quotation marks in the output. Can you write a statement like this?

```
System.out.println("He said "Java is fun"");
```

No, this statement has a compile error. The compiler thinks the second quotation character is the end of the string and does not know what to do with the rest of the characters.

To overcome this problem, Java uses a special notation to represent special characters, as shown in Table 2.6. This special notation, called an *escape character*, consists of a backslash (`\`) followed by a character or a character sequence. For example, `\t` is an escape character for the Tab character and an escape character such as `\u03b1` is used to represent a Unicode. The symbols in an escape character are interpreted as a whole rather than individually.

So, now you can print the quoted message using the following statement:

```
System.out.println("He said \"Java is fun\"");
```

The output is

```
He said "Java is fun"
```

Note that the symbols `\` and `"` together represent one character.

2.17.3 Casting between `char` and Numeric Types

A `char` can be cast into any numeric type, and vice versa. When an integer is cast into a `char`, only its lower 16 bits of data are used; the other part is ignored. For example:

```

char ch = (char)0XAB0041; // The lower 16 bits hex code 0041 is
                        // assigned to ch
System.out.println(ch); // ch is character A

```

TABLE 2.6 Escape Characters

<i>Escape Character</i>	<i>Name</i>	<i>Unicode Code</i>	<i>Decimal Value</i>
<code>\b</code>	Backspace	<code>\u0008</code>	8
<code>\t</code>	Tab	<code>\u0009</code>	9
<code>\n</code>	Linefeed	<code>\u000A</code>	10
<code>\f</code>	Formfeed	<code>\u000C</code>	12
<code>\r</code>	Carriage Return	<code>\u000D</code>	13
<code>\\</code>	Backslash	<code>\u005C</code>	92
<code>\"</code>	Double Quote	<code>\u0022</code>	34

When a floating-point value is cast into a `char`, the floating-point value is first cast into an `int`, which is then cast into a `char`.

```
char ch = (char)65.25; // Decimal 65 is assigned to ch
System.out.println(ch); // ch is character A
```

When a `char` is cast into a numeric type, the character's Unicode is cast into the specified numeric type.

```
int i = (int)'A'; // The Unicode of character A is assigned to i
System.out.println(i); // i is 65
```

Implicit casting can be used if the result of a casting fits into the target variable. Otherwise, explicit casting must be used. For example, since the Unicode of `'a'` is `97`, which is within the range of a byte, these implicit castings are fine:

```
byte b = 'a';
int i = 'a';
```

But the following casting is incorrect, because the Unicode `\uFFFF4` cannot fit into a byte:

```
byte b = '\uFFFF4';
```

To force this assignment, use explicit casting, as follows:

```
byte b = (byte)\uFFFF4';
```

Any positive integer between `0` and `FFFF` in hexadecimal can be cast into a character implicitly. Any number not in this range must be cast into a `char` explicitly.

numeric operators on
characters



Note

All numeric operators can be applied to `char` operands. A `char` operand is automatically cast into a number if the other operand is a number or a character. If the other operand is a string, the character is concatenated with the string. For example, the following statements

```
int i = '2' + '3'; // (int)'2' is 50 and (int)'3' is 51
System.out.println("i is " + i); // i is 101
```

```

int j = 2 + 'a'; // (int)'a' is 97
System.out.println("j is " + j); // j is 99
System.out.println(j + " is the Unicode for character "
    + (char)j); // j is the Unicode for character c
System.out.println("Chapter " + '2');

display

i is 101
j is 99
99 is the Unicode for character c
Chapter 2

```



Note

The Unicodes for lowercase letters are consecutive integers starting from the Unicode for 'a', then for 'b', 'c', . . . , and 'z'. The same is true for the uppercase letters. Furthermore, the Unicode for 'a' is greater than the Unicode for 'A', so 'a' - 'A' is the same as 'b' - 'B'. For a lowercase letter *ch*, its corresponding uppercase letter is `(char)('A' + (ch - 'a'))`.

2.17.4 Case Study: Counting Monetary Units

Suppose you want to develop a program that changes a given amount of money into smaller monetary units. The program lets the user enter an amount as a `double` value representing a total in dollars and cents, and outputs a report listing the monetary equivalent in the maximum number of dollars, quarters, dimes, nickels, and pennies, in this order, to result in the minimum number of coins, as shown in the sample run.

Here are the steps in developing the program:

1. Prompt the user to enter the amount as a decimal number, such as `11.56`.
2. Convert the amount (e.g., `11.56`) into cents (`1156`).
3. Divide the cents by `100` to find the number of dollars. Obtain the remaining cents using the cents remainder `100`.
4. Divide the remaining cents by `25` to find the number of quarters. Obtain the remaining cents using the remaining cents remainder `25`.
5. Divide the remaining cents by `10` to find the number of dimes. Obtain the remaining cents using the remaining cents remainder `10`.
6. Divide the remaining cents by `5` to find the number of nickels. Obtain the remaining cents using the remaining cents remainder `5`.
7. The remaining cents are the pennies.
8. Display the result.

The complete program is given in Listing 2.10.

LISTING 2.10 ComputeChange.java

```

1  import java.util.Scanner;
2
3  public class ComputeChange {
4      public static void main(String[] args) {
5          // Create a Scanner
6          Scanner input = new Scanner(System.in);
7
8          // Receive the amount
9          System.out.print(

```

import class

The variable `amount` stores the amount entered from the console (line 11). This variable is not changed, because the amount has to be used at the end of the program to display the results. The program introduces the variable `remainingAmount` (line 13) to store the changing remaining amount.

The variable `amount` is a `double` decimal representing dollars and cents. It is converted to an `int` variable `remainingAmount`, which represents all the cents. For instance, if `amount` is `11.56`, then the initial `remainingAmount` is `1156`. The division operator yields the integer part of the division, so `1156 / 100` is `11`. The remainder operator obtains the remainder of the division, so `1156 % 100` is `56`.

The program extracts the maximum number of singles from the remaining amount and obtains a new remaining amount in the variable `remainingAmount` (lines 16–17). It then extracts the maximum number of quarters from `remainingAmount` and obtains a new `remainingAmount` (lines 20–21). Continuing the same process, the program finds the maximum number of dimes, nickels, and pennies in the remaining amount.

One serious problem with this example is the possible loss of precision when casting a `double` amount to an `int remainingAmount`. This could lead to an inaccurate result. If you try to enter the amount `10.03`, `10.03 * 100` becomes `1002.9999999999999`. You will find that the program displays `10` dollars and `2` pennies. To fix the problem, enter the amount as an integer value representing cents (see Exercise 2.24).

loss of precision

As shown in the sample run, `0` dimes, `1` nickels, and `1` pennies are displayed in the result. It would be better not to display `0` dimes, and to display `1` nickel and `1` penny using the singular forms of the words. You will learn how to use selection statements to modify this program in the next chapter (see Exercise 3.7).

2.26 Use print statements to find out the ASCII code for `'1'`, `'A'`, `'B'`, `'a'`, and `'b'`. Use print statements to find out the character for the decimal codes `40`, `59`, `79`, `85`, and `90`. Use print statements to find out the character for the hexadecimal code `40`, `5A`, `71`, `72`, and `7A`.



MyProgrammingLab™

2.27 Which of the following are correct literals for characters?

`'1'`, `'\u345dE'`, `'\u3fFa'`, `'\b'`, `'\t'`

2.28 How do you display the characters `\` and `"`?

2.29 Evaluate the following:

```
int i = '1';
int j = '1' + '2' * ('4' - '3') + 'b' / 'a';
int k = 'a';
char c = 90;
```

2.30 Can the following conversions involving casting be allowed? If so, find the converted result.

```
char c = 'A';
int i = (int)c;
```

```
float f = 1000.34f;
int i = (int)f;
```

```
double d = 1000.34;
int i = (int)d;
```

```
int i = 97;
char c = (char)i;
```

2.31 Show the output of the following program:

```
public class Test {
    public static void main(String[] args) {
        char x = 'a';
        char y = 'c';

        System.out.println(++x);
        System.out.println(y++);
        System.out.println(x - y);
    }
}
```

2.18 The String Type



A string is a sequence of characters.

The **char** type represents only one character. To represent a string of characters, use the data type called **String**. For example, the following code declares the message to be a string with the value "Welcome to Java".

```
String message = "Welcome to Java";
```

String is a predefined class in the Java library, just like the classes **System**, **JOptionPane**, and **Scanner**. The **String** type is not a primitive type. It is known as a *reference type*. Any Java class can be used as a reference type for a variable. Reference data types will be thoroughly discussed in Chapter 8, Objects and Classes. For the time being, you need to know only how to declare a **String** variable, how to assign a string to the variable, and how to concatenate strings.

As first shown in Listing 2.1, two strings can be concatenated. The plus sign (+) is the concatenation operator if one of the operands is a string. If one of the operands is a nonstring (e.g., a number), the nonstring value is converted into a string and concatenated with the other string. Here are some examples:

```
// Three strings are concatenated
String message = "Welcome " + "to " + "Java";

// String Chapter is concatenated with number 2
String s = "Chapter" + 2; // s becomes Chapter2

// String Supplement is concatenated with character B
String s1 = "Supplement" + 'B'; // s1 becomes SupplementB
```

If neither of the operands is a string, the plus sign (+) is the addition operator that adds two numbers.

The augmented += operator can also be used for string concatenation. For example, the following code appends the string "and Java is fun" with the string "Welcome to Java" in **message**.

```
message += " and Java is fun";
```

So the new **message** is "Welcome to Java and Java is fun".

If **i = 1** and **j = 2**, what is the output of the following statement?

```
System.out.println("i + j is " + i + j);
```

The output is "i + j is 12" because "i + j is " is concatenated with the value of **i** first. To force **i + j** to be executed first, enclose **i + j** in the parentheses, as follows:

```
System.out.println("i + j is " + (i + j));
```

concatenate strings and numbers

To read a string from the console, invoke the `next()` method on a **Scanner** object. For example, the following code reads three strings from the keyboard:

```
Scanner input = new Scanner(System.in);
System.out.println("Enter three words separated by spaces: ");
String s1 = input.next();
String s2 = input.next();
String s3 = input.next();
System.out.println("s1 is " + s1);
System.out.println("s2 is " + s2);
System.out.println("s3 is " + s3);
```

```
Enter three words separated by spaces: Welcome to Java ↵ Enter
s1 is Welcome
s2 is to
s3 is Java
```



The `next()` method reads a string that ends with a whitespace character. The characters ' ', '\t', '\f', '\r', or '\n' are known as *whitespace characters*.

whitespace character

You can use the `nextLine()` method to read an entire line of text. The `nextLine()` method reads a string that ends with the *Enter* key pressed. For example, the following statements read a line of text.

```
Scanner input = new Scanner(System.in);
System.out.println("Enter a line: ");
String s = input.nextLine();
System.out.println("The line entered is " + s);
```

```
Enter a line: Welcome to Java ↵ Enter
The line entered is Welcome to Java
```



Important Caution

To avoid input errors, do not use `nextLine()` after `nextByte()`, `nextShort()`, `nextInt()`, `nextLong()`, `nextFloat()`, `nextDouble()`, or `next()`. The reasons will be explained in Section 14.11.3, "How Does **Scanner** Work?"

avoid input errors

2.32 Show the output of the following statements (write a program to verify your results):

```
System.out.println("1" + 1);
System.out.println('1' + 1);
System.out.println("1" + 1 + 1);
System.out.println("1" + (1 + 1));
System.out.println('1' + 1 + 1);
```



MyProgrammingLab™

2.33 Evaluate the following expressions (write a program to verify your results):

```
1 + "Welcome " + 1 + 1
1 + "Welcome " + (1 + 1)
1 + "Welcome " + ('\u0001' + 1)
1 + "Welcome " + 'a' + 1
```

2.19 Getting Input from Input Dialogs



An input dialog box prompts the user to enter an input graphically.

JOptionPane class

You can obtain input from the console. Alternatively, you can obtain input from an input dialog box by invoking the `JOptionPane.showInputDialog` method, as shown in Figure 2.4.

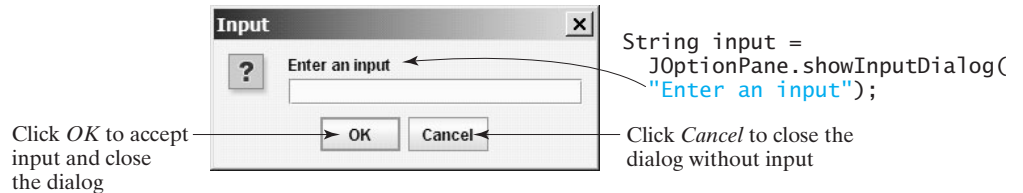


FIGURE 2.4 The input dialog box enables the user to enter a string.

When this method is executed, a dialog is displayed to enable you to enter an input value. After entering a string, click *OK* to accept the input and close the dialog box. The input is returned from the method as a string.

showInputDialog method

There are several ways to use the `showInputDialog` method. For the time being, you need to know only two ways to invoke it.

One is to use a statement like this one:

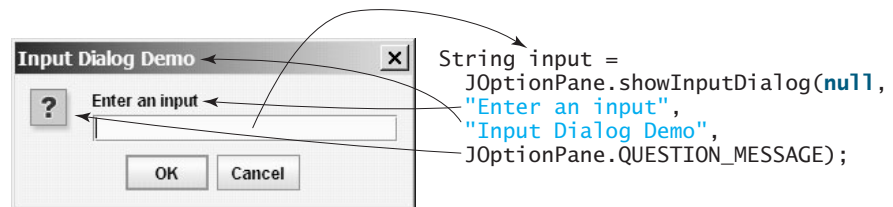
```
JOptionPane.showInputDialog(x);
```

where **x** is a string for the prompting message.

The other is to use a statement such as the following:

```
String string = JOptionPane.showInputDialog(null, x,
    y, JOptionPane.QUESTION_MESSAGE);
```

where **x** is a string for the prompting message and **y** is a string for the title of the input dialog box, as shown in the example below.



2.19.1 Converting Strings to Numbers

The input returned from the input dialog box is a string. If you enter a numeric value such as **123**, it returns **"123"**. You have to convert a string into a number to obtain the input as a number.

Integer.parseInt method

To convert a string into an **int** value, use the `Integer.parseInt` method, as follows:

```
int intValue = Integer.parseInt(intString);
```

where **intString** is a numeric string such as **123**.

Double.parseDouble method

To convert a string into a **double** value, use the `Double.parseDouble` method, as follows:

```
double doubleValue = Double.parseDouble(doubleString);
```

where **doubleString** is a numeric string such as **123.45**.

The `Integer` and `Double` classes are both included in the `java.lang` package, and thus they are automatically imported.

2.19.2 Using Input Dialog Boxes

Having learned how to read input from an input dialog box, you can rewrite the program in Listing 2.8, `ComputeLoan.java`, to read from input dialog boxes rather than from the console. Listing 2.11 gives the complete program. Figure 2.5 shows a sample run of the program.

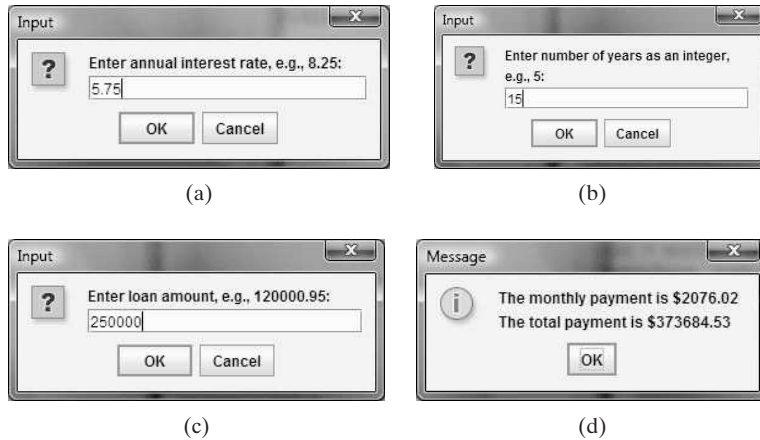


FIGURE 2.5 The program accepts the annual interest rate (a), number of years (b), and loan amount (c), then displays the monthly payment and total payment (d).

LISTING 2.11 `ComputeLoanUsingInputDialog.java`

```

1  import javax.swing.JOptionPane;
2
3  public class ComputeLoanUsingInputDialog {
4      public static void main(String[] args) {
5          // Enter annual interest rate
6          String annualInterestRateString = JOptionPane.showInputDialog(   enter interest rate
7              "Enter annual interest rate, for example, 8.25:");
8
9          // Convert string to double
10         double annualInterestRate =                                     convert string to double
11             Double.parseDouble(annualInterestRateString);
12
13         // Obtain monthly interest rate
14         double monthlyInterestRate = annualInterestRate / 1200;
15
16         // Enter number of years
17         String numberOfYearsString = JOptionPane.showInputDialog(
18             "Enter number of years as an integer, for example, 5:");
19
20         // Convert string to int
21         int numberOfYears = Integer.parseInt(numberOfYearsString);
22
23         // Enter loan amount
24         String loanString = JOptionPane.showInputDialog(
25             "Enter loan amount, for example, 120000.95:");
26
27         // Convert string to double
28         double loanAmount = Double.parseDouble(loanString);
29

```

72 Chapter 2 Elementary Programming

```
monthlyPayment    30    // Calculate payment
                  31    double monthlyPayment = loanAmount * monthlyInterestRate / (1
totalPayment      32    - 1 / Math.pow(1 + monthlyInterestRate, numberOfYears * 12));
                  33    double totalPayment = monthlyPayment * numberOfYears * 12;
                  34
preparing output  35    // Format to keep two digits after the decimal point
                  36    monthlyPayment = (int)(monthlyPayment * 100) / 100.0;
                  37    totalPayment = (int)(totalPayment * 100) / 100.0;
                  38
                  39    // Display results
                  40    String output = "The monthly payment is $" + monthlyPayment +
                  41    "\n\nThe total payment is $" + totalPayment;
                  42    JOptionPane.showMessageDialog(null, output);
                  43    }
                  44 }
```

The `showInputDialog` method in lines 6–7 displays an input dialog. Enter the interest rate as a double value and click *OK* to accept the input. The value is returned as a string that is assigned to the `String` variable `annualInterestRateString`. The `Double.parseDouble` (`annualInterestRateString`) (line 11) is used to convert the string into a `double` value.

JOptionPane or Scanner?



Pedagogical Note

For obtaining input you can use either `JOptionPane` or `Scanner`—whichever is more convenient. For consistency and simplicity, the examples in this book use `Scanner` for getting input. You can easily revise the examples using `JOptionPane` for getting input.



2.34 Why do you have to import `JOptionPane` but not the `Math` class?

2.35 How do you prompt the user to enter an input using a dialog box?

2.36 How do you convert a string to an integer? How do you convert a string to a double?

MyProgrammingLab™

KEY TERMS

algorithm	34	increment operator (++)	54
assignment operator (=)	42	incremental development	
assignment statement	42	and testing	37
byte type	45	int type	45
casting	56	IPO	39
char type	62	literal	48
constant	43	long type	45
data type	35	narrowing (of types)	56
declare variables	35	operands	46
decrement operator (--)	54	operator	46
double type	45	overflow	45
encoding	62	postdecrement	54
escape character	63	postincrement	54
expression	42	predecrement	54
final keyword	43	preincrement	54
float type	45	primitive data type	35
floating-point number	35	pseudocode	34
identifier	40	requirements specification	58

scope of a variable	42	Unicode	62
short type	45	UNIX epoch	51
supplementary Unicode	62	variable	35
system analysis	58	whitespace character	69
system design	58	widening (of types)	56
underflow	46		

CHAPTER SUMMARY

1. *Identifiers* are names for naming elements such as variables, constants, methods, classes, packages in a program.
2. An identifier is a sequence of characters that consists of letters, digits, underscores (`_`), and dollar signs (`$`). An identifier must start with a letter or an underscore. It cannot start with a digit. An identifier cannot be a reserved word. An identifier can be of any length.
3. *Variables* are used to store data in a program.
4. To declare a variable is to tell the compiler what type of data a variable can hold.
5. In Java, the equal sign (`=`) is used as the *assignment operator*.
6. A variable declared in a method must be assigned a value before it can be used.
7. A *named constant* (or simply a *constant*) represents permanent data that never changes.
8. A named constant is declared by using the keyword `final`.
9. Java provides four integer types (`byte`, `short`, `int`, and `long`) that represent integers of four different sizes.
10. Java provides two *floating-point types* (`float` and `double`) that represent floating-point numbers of two different precisions.
11. Java provides *operators* that perform numeric operations: `+` (addition), `-` (subtraction), `*` (multiplication), `/` (division), and `%` (remainder).
12. Integer arithmetic (`/`) yields an integer result.
13. The numeric operators in a Java expression are applied the same way as in an arithmetic expression.
14. Java provides the augmented assignment operators `+=` (addition assignment), `-=` (subtraction assignment), `*=` (multiplication assignment), `/=` (division assignment), and `%=` (remainder assignment).
15. The *increment operator* (`++`) and the *decrement operator* (`--`) increment or decrement a variable by `1`.
16. When evaluating an expression with values of mixed types, Java automatically converts the operands to appropriate types.
17. You can explicitly convert a value from one type to another using the `(type)value` notation.

18. *Casting* a variable of a type with a small range to a variable of a type with a larger range is known as *widening a type*.
19. Casting a variable of a type with a large range to a variable of a type with a smaller range is known as *narrowing a type*.
20. Widening a type can be performed automatically without explicit casting. Narrowing a type must be performed explicitly.
21. The character type `char` represents a single character.
22. An *escape character* is a notation for representing a special character. An escape character consists of a backslash (`\`) followed by a character or a character sequence.
23. The characters `' '`, `\t`, `\f`, `\r`, and `\n` are known as the whitespace characters.
24. In computer science, midnight of January 1, 1970, is known as the *UNIX epoch*.

TEST QUESTIONS

Do the test questions for this chapter online at www.cs.armstrong.edu/liang/intro9e/test.html.

MyProgrammingLab™

PROGRAMMING EXERCISES

sample runs



Note

You can run all exercises by downloading `exercise9e.zip` from www.cs.armstrong.edu/liang/intro9e/exercise9e.zip and use the command `java -cp exercise9e.zip Exercisei_j` to run `Exercisei_j`. For example, to run Exercise 2.1, use

```
java -cp exercise9e.zip Exercise02_01
```

This will give you an idea how the program runs.

learn from examples



Debugging TIP

The compiler usually gives a reason for a syntax error. If you don't know how to correct it, compare your program closely, character by character, with similar examples in the text.

document analysis and design



Pedagogical Note

Instructors may ask you to document your analysis and design for selected exercises. Use your own words to analyze the problem, including the input, output, and what needs to be computed, and describe how to solve the problem in pseudocode.

Sections 2.2–2.12

- 2.1 (*Convert Celsius to Fahrenheit*) Write a program that reads a Celsius degree in a `double` value from the console, then converts it to Fahrenheit and displays the result. The formula for the conversion is as follows:

$$\text{fahrenheit} = (9 / 5) * \text{celsius} + 32$$

Hint: In Java, `9 / 5` is `1`, but `9.0 / 5` is `1.8`.

Here is a sample run:

```
Enter a degree in Celsius: 43 ↵Enter
43 Celsius is 109.4 Fahrenheit
```



- 2.2** (*Compute the volume of a cylinder*) Write a program that reads in the radius and length of a cylinder and computes the area and volume using the following formulas:

```
area = radius * radius * π
volume = area * length
```

Here is a sample run:

```
Enter the radius and length of a cylinder: 5.5 12 ↵Enter
The area is 95.0331
The volume is 1140.4
```



- 2.3** (*Convert feet into meters*) Write a program that reads a number in feet, converts it to meters, and displays the result. One foot is **0.305** meter. Here is a sample run:

```
Enter a value for feet: 16.5 ↵Enter
16.5 feet is 5.0325 meters
```



- 2.4** (*Convert pounds into kilograms*) Write a program that converts pounds into kilograms. The program prompts the user to enter a number in pounds, converts it to kilograms, and displays the result. One pound is **0.454** kilograms. Here is a sample run:

```
Enter a number in pounds: 55.5 ↵Enter
55.5 pounds is 25.197 kilograms
```



- *2.5** (*Financial application: calculate tips*) Write a program that reads the subtotal and the gratuity rate, then computes the gratuity and total. For example, if the user enters **10** for subtotal and **15%** for gratuity rate, the program displays **\$1.5** as gratuity and **\$11.5** as total. Here is a sample run:

```
Enter the subtotal and a gratuity rate: 10 15 ↵Enter
The gratuity is $1.5 and total is $11.5
```



- **2.6** (*Sum the digits in an integer*) Write a program that reads an integer between **0** and **1000** and adds all the digits in the integer. For example, if an integer is **932**, the sum of all its digits is **14**.

Hint: Use the **%** operator to extract digits, and use the **/** operator to remove the extracted digit. For instance, **932 % 10 = 2** and **932 / 10 = 93**.

Here is a sample run:

```
Enter a number between 0 and 1000: 999 ↵Enter
The sum of the digits is 27
```



- *2.7** (*Find the number of years*) Write a program that prompts the user to enter the minutes (e.g., 1 billion), and displays the number of years and days for the minutes. For simplicity, assume a year has **365** days. Here is a sample run:



```
Enter the number of minutes: 1000000000 
1000000000 minutes is approximately 1902 years and 214 days
```

- *2.8** (*Current time*) Listing 2.6, ShowCurrentTime.java, gives a program that displays the current time in GMT. Revise the program so that it prompts the user to enter the time zone offset to GMT and displays the time in the specified time zone. Here is a sample run:



```
Enter the time zone offset to GMT: -5 
The current time is 4:50:34
```

- 2.9** (*Physics: acceleration*) Average acceleration is defined as the change of velocity divided by the time taken to make the change, as shown in the following formula:

$$a = \frac{v_1 - v_0}{t}$$

Write a program that prompts the user to enter the starting velocity v_0 in meters/second, the ending velocity v_1 in meters/second, and the time span t in seconds, and displays the average acceleration. Here is a sample run:



```
Enter v0, v1, and t: 5.5 50.9 4.5 
The average acceleration is 10.0889
```

- 2.10** (*Science: calculating energy*) Write a program that calculates the energy needed to heat water from an initial temperature to a final temperature. Your program should prompt the user to enter the amount of water in kilograms and the initial and final temperatures of the water. The formula to compute the energy is

$$Q = M * (\text{finalTemperature} - \text{initialTemperature}) * 4184$$

where **M** is the weight of water in kilograms, temperatures are in degrees Celsius, and energy **Q** is measured in joules. Here is a sample run:



```
Enter the amount of water in kilograms: 55.5 
Enter the initial temperature: 3.5 
Enter the final temperature: 10.5 
The energy needed is 1625484.0
```

- 2.11** (*Population projection*) Rewrite Exercise 1.11 to prompt the user to enter the number of years and displays the population after the number of years. Here is a sample run of the program:


```
Enter the number of years: 5 ↵ Enter
The population in 5 years is 325932970
```



- 2.12** (*Physics: finding runway length*) Given an airplane's acceleration a and take-off speed v , you can compute the minimum runway length needed for an airplane to take off using the following formula:

$$\text{length} = \frac{v^2}{2a}$$

Write a program that prompts the user to enter v in meters/second (m/s) and the acceleration a in meters/second squared (m/s²), and displays the minimum runway length. Here is a sample run:

```
Enter speed and acceleration: 60 3.5 ↵ Enter
The minimum runway length for this airplane is 514.286
```



- **2.13** (*Financial application: compound value*) Suppose you save \$100 each month into a savings account with the annual interest rate 5%. Thus, the monthly interest rate is $0.05/12 = 0.00417$. After the first month, the value in the account becomes

$$100 * (1 + 0.00417) = 100.417$$

After the second month, the value in the account becomes

$$(100 + 100.417) * (1 + 0.00417) = 201.252$$

After the third month, the value in the account becomes

$$(100 + 201.252) * (1 + 0.00417) = 302.507$$

and so on.

Write a program that prompts the user to enter a monthly saving amount and displays the account value after the sixth month. (In Exercise 4.30, you will use a loop to simplify the code and display the account value for any month.)

```
Enter the monthly saving amount: 100 ↵ Enter
After the sixth month, the account value is $608.81
```



- *2.14** (*Health application: computing BMI*) Body Mass Index (BMI) is a measure of health on weight. It can be calculated by taking your weight in kilograms and dividing by the square of your height in meters. Write a program that prompts the user to enter a weight in pounds and height in inches and displays the BMI. Note that one pound is **0.45359237** kilograms and one inch is **0.0254** meters. Here is a sample run:



VideoNote
Compute BMI



```
Enter weight in pounds: 95.5 ↵Enter
Enter height in inches: 50 ↵Enter
BMI is 26.8573
```

- *2.15** (*Geometry: area of a triangle*) Write a program that prompts the user to enter three points (x_1, y_1) , (x_2, y_2) , (x_3, y_3) of a triangle and displays its area. The formula for computing the area of a triangle is

$$s = (side1 + side2 + side3)/2;$$

$$area = \sqrt{s(s - side1)(s - side2)(s - side3)}$$

Here is a sample run:



```
Enter three points for a triangle: 1.5 -3.4 4.6 5 9.5 -3.4 ↵Enter
The area of the triangle is 33.6
```

- 2.16** (*Geometry: area of a hexagon*) Write a program that prompts the user to enter the side of a hexagon and displays its area. The formula for computing the area of a hexagon is

$$Area = \frac{3\sqrt{3}}{2}s^2,$$

where s is the length of a side. Here is a sample run:



```
Enter the side: 5.5 ↵Enter
The area of the hexagon is 78.5895
```

- *2.17** (*Science: wind-chill temperature*) How cold is it outside? The temperature alone is not enough to provide the answer. Other factors including wind speed, relative humidity, and sunshine play important roles in determining coldness outside. In 2001, the National Weather Service (NWS) implemented the new wind-chill temperature to measure the coldness using temperature and wind speed. The formula is:

$$t_{wc} = 35.74 + 0.6215t_a - 35.75v^{0.16} + 0.4275t_av^{0.16}$$

where t_a is the outside temperature measured in degrees Fahrenheit and v is the speed measured in miles per hour. t_{wc} is the wind-chill temperature. The formula cannot be used for wind speeds below 2 mph or temperatures below -58°F or above 41°F .

Write a program that prompts the user to enter a temperature between -58°F and 41°F and a wind speed greater than or equal to 2 and displays the wind-chill temperature. Use `Math.pow(a, b)` to compute $v^{0.16}$. Here is a sample run:



```
Enter the temperature in Fahrenheit: 5.3 ↵Enter
Enter the wind speed in miles per hour: 6 ↵Enter
The wind chill index is -5.56707
```

2.18 (*Print a table*) Write a program that displays the following table:

a	b	pow(a, b)
1	2	1
2	3	8
3	4	81
4	5	1024
5	6	15625

2.19 (*Geometry: distance of two points*) Write a program that prompts the user to enter two points (**x1**, **y1**) and (**x2**, **y2**) and displays their distance between them. The formula for computing the distance is $\sqrt{(x_2 - x_1)^2 + (y_2 - y_1)^2}$. Note that you can use **Math.pow(a, 0.5)** to compute \sqrt{a} . Here is a sample run:

```
Enter x1 and y1: 1.5 -3.4 ↵ Enter
Enter x2 and y2: 4 5 ↵ Enter
The distance between the two points is 8.764131445842194
```



Sections 2.13–2.16

***2.20** (*Financial application: calculate interest*) If you know the balance and the annual percentage interest rate, you can compute the interest on the next monthly payment using the following formula:

$$\text{interest} = \text{balance} \times (\text{annualInterestRate} / 1200)$$

Write a program that reads the balance and the annual percentage interest rate and displays the interest for the next month. Here is a sample run:

```
Enter balance and interest rate (e.g., 3 for 3%): 1000 3.5 ↵ Enter
The interest is 2.91667
```



***2.21** (*Financial application: calculate future investment value*) Write a program that reads in investment amount, annual interest rate, and number of years, and displays the future investment value using the following formula:

$$\text{futureInvestmentValue} = \text{investmentAmount} \times (1 + \text{monthlyInterestRate})^{\text{numberOfYears} \times 12}$$

For example, if you enter amount **1000**, annual interest rate **3.25%**, and number of years **1**, the future investment value is **1032.98**.

Here is a sample run:

```
Enter investment amount: 1000 ↵ Enter
Enter annual interest rate in percentage: 4.25 ↵ Enter
Enter number of years: 1 ↵ Enter
Accumulated value is $1043.34
```



Sections 2.17–2.18

- 2.22** (*Random character*) Write a program that displays a random uppercase letter using the `System.currentTimeMillis()` method.
- 2.23** (*Find the character of an ASCII code*) Write a program that receives an ASCII code (an integer between 0 and 127) and displays its character. For example, if the user enters `97`, the program displays character `a`. Here is a sample run:



```
Enter an ASCII code: 69 [Enter]
The character is E
```

- *2.24** (*Financial application: monetary units*) Rewrite Listing 2.10, `ComputeChange.java`, to fix the possible loss of accuracy when converting a `double` value to an `int` value. Enter the input as an integer whose last two digits represent the cents. For example, the input `1156` represents `11` dollars and `56` cents.
- *2.25** (*Financial application: payroll*) Write a program that reads the following information and prints a payroll statement:

```
Employee's name (e.g., Smith)
Number of hours worked in a week (e.g., 10)
Hourly pay rate (e.g., 6.75)
Federal tax withholding rate (e.g., 20%)
State tax withholding rate (e.g., 9%)
```



```
Enter employee's name: Smith [Enter]
Enter number of hours worked in a week: 10 [Enter]
Enter hourly pay rate: 6.75 [Enter]
Enter federal tax withholding rate: 0.20 [Enter]
Enter state tax withholding rate: 0.09 [Enter]
```

```
Employee Name: Smith
Hours Worked: 10.0
Pay Rate: $6.75
Gross Pay: $67.5
Deductions:
    Federal Withholding (20.0%): $13.5
    State Withholding (9.0%): $6.07
    Total Deduction: $19.57
Net Pay: $47.92
```

Section 2.19

- *2.26** (*Use input dialog*) Rewrite Listing 2.10, `ComputeChange.java`, using input and output dialog boxes.
- *2.27** (*Financial application: payroll*) Rewrite Exercise 2.25 using GUI input and output dialog boxes.

SELECTIONS

Objectives

- To declare **boolean** variables and write Boolean expressions using comparison operators (§3.2).
- To implement selection control using one-way **if** statements (§3.3).
- To program using one-way **if** statements (**GuessBirthday**) (§3.4).
- To implement selection control using two-way **if-else** statements (§3.5).
- To implement selection control using nested **if** and multi-way **if** statements (§3.6).
- To avoid common errors in **if** statements (§3.7).
- To generate random numbers using the **Math.random()** method (§3.8).
- To program using selection statements for a variety of examples (**SubtractionQuiz**, **BMI**, **ComputeTax**) (§§3.8–3.10).
- To combine conditions using logical operators (**&&**, **||**, and **!**) (§3.11).
- To program using selection statements with combined conditions (**LeapYear**, **Lottery**) (§§3.12–3.13).
- To implement selection control using **switch** statements (§3.14).
- To write expressions using the conditional operator (§3.15).
- To format output using the **System.out.printf** method (§3.16).
- To examine the rules governing operator precedence and associativity (§3.17).
- To get user confirmation using confirmation dialogs (§3.18).
- To apply common techniques to debug errors (§3.19).



3.1 Introduction



The program can decide which statements to execute based on a condition.

problem

If you enter a negative value for **radius** in Listing 2.2, `ComputeAreaWithConsoleInput.java`, the program displays an invalid result. If the radius is negative, you don't want the program to compute the area. How can you deal with this situation?

selection statements

Like all high-level programming languages, Java provides *selection statements*: statements that let you choose actions with two or more alternative courses. You can use the following selection statement to replace lines 12–17 in Listing 2.2:

```
if (radius < 0) {
    System.out.println("Incorrect input");
}
else {
    area = radius * radius * 3.14159;
    System.out.println("Area is " + area);
}
```

Boolean expression
Boolean value

Selection statements use conditions that are Boolean expressions. A *Boolean expression* is an expression that evaluates to a *Boolean value*: **true** or **false**. We now introduce Boolean types and comparison operators.

3.2 boolean Data Type



A boolean data type declares a variable with the value either true or false.

boolean data type
comparison operators

How do you compare two values, such as whether a radius is greater than **0**, equal to **0**, or less than **0**? Java provides six *comparison operators* (also known as *relational operators*), shown in Table 3.1, which can be used to compare two values (assume radius is **5** in the table).

TABLE 3.1 Comparison Operators

Java Operator	Mathematics Symbol	Name	Example (radius is 5)	Result
<	<	less than	radius < 0	false
<=	≤	less than or equal to	radius <= 0	false
>	>	greater than	radius > 0	true
>=	≥	greater than or equal to	radius >= 0	true
==	=	equal to	radius == 0	false
!=	≠	not equal to	radius != 0	true

compare characters



Note

You can also compare characters. Comparing characters is the same as comparing their Unicodes. For example, **a** is larger than **A** because the Unicode of **a** is larger than the Unicode of **A**. See Appendix B, The ASCII Character Set, to find the order of characters.

== vs. =



Caution

The equality comparison operator is two equal signs (**==**), not a single equal sign (**=**). The latter symbol is for assignment.

The result of the comparison is a Boolean value: **true** or **false**. For example, the following statement displays **true**:

```
double radius = 1;
System.out.println(radius > 0);
```

A variable that holds a Boolean value is known as a *Boolean variable*. The **boolean** data type is used to declare Boolean variables. A **boolean** variable can hold one of the two values: **true** or **false**. For example, the following statement assigns **true** to the variable **lightsOn**:

```
boolean lightsOn = true;
```

true and **false** are literals, just like a number such as **10**. They are reserved words and cannot be used as identifiers in your program.

Suppose you want to develop a program to let a first-grader practice addition. The program randomly generates two single-digit integers, **number1** and **number2**, and displays to the student a question such as “What is 1 + 7?”, as shown in the sample run in Listing 3.1. After the student types the answer, the program displays a message to indicate whether it is true or false.

There are several ways to generate random numbers. For now, generate the first integer using **System.currentTimeMillis() % 10** and the second using **System.currentTimeMillis() / 7 % 10**. Listing 3.1 gives the program. Lines 5–6 generate two numbers, **number1** and **number2**. Line 14 obtains an answer from the user. The answer is graded in line 18 using a Boolean expression **number1 + number2 == answer**.

LISTING 3.1 AdditionQuiz.java

```
1 import java.util.Scanner;
2
3 public class AdditionQuiz {
4     public static void main(String[] args) {
5         int number1 = (int)(System.currentTimeMillis() % 10);
6         int number2 = (int)(System.currentTimeMillis() / 7 % 10);
7
8         // Create a Scanner
9         Scanner input = new Scanner(System.in);
10
11        System.out.print(
12            "What is " + number1 + " + " + number2 + "? ");
13
14        int answer = input.nextInt();
15
16        System.out.println(
17            number1 + " + " + number2 + " = " + answer + " is " +
18            (number1 + number2 == answer));
19    }
20 }
```

Boolean variable

Boolean literals



VideoNote

Program addition quiz

generate number1

generate number2

show question

display result

```
What is 1 + 7? 8  Enter
1 + 7 = 8 is true
```



```
What is 4 + 8? 9  Enter
4 + 8 = 9 is false
```



line#	number1	number2	answer	output
5	4			
6		8		
14			9	
16				4 + 8 = 9 is false



MyProgrammingLab™

- 3.1** List six comparison operators.
3.2 Show the printout of the following statements:

```
System.out.println('a' < 'b');
System.out.println('a' <= 'A');
System.out.println('a' > 'b');
System.out.println('a' >= 'A');
System.out.println('a' == 'a');
System.out.println('a' != 'b');
```

- 3.3** Can the following conversions involving casting be allowed? If so, find the converted result.

```
boolean b = true;
i = (int)b;

int i = 1;
boolean b = (boolean)i;
```

3.3 if Statements



An *if* statement executes the statements if the condition is true.

The preceding program displays a message such as “6 + 2 = 7 is false.” If you wish the message to be “6 + 2 = 7 is incorrect,” you have to use a selection statement to make this minor change.

Java has several types of selection statements: one-way **if** statements, two-way **if-else** statements, nested **if** statements, **switch** statements, and conditional expressions.

A one-way **if** statement executes an action if and only if the condition is **true**. The syntax for a one-way **if** statement is:

```
if (boolean-expression) {
    statement(s);
}
```

The flowchart in Figure 3.1 illustrates how Java executes the syntax of an **if** statement. A *flowchart* is a diagram that describes an algorithm or process, showing the steps as boxes of various kinds, and their order by connecting these with arrows. Process operations are represented in these boxes, and arrows connecting them represent the flow of control. A diamond box is used to denote a Boolean condition and a rectangle box is for representing statements.

If the **boolean-expression** evaluates to **true**, the statements in the block are executed. As an example, see the following code:

```
if (radius >= 0) {
    area = radius * radius * PI;
    System.out.println("The area for the circle of radius " +
        radius + " is " + area);
}
```

The flowchart of the preceding statement is shown in Figure 3.1b. If the value of **radius** is greater than or equal to **0**, then the **area** is computed and the result is displayed; otherwise, the two statements in the block will not be executed.

The **boolean-expression** is enclosed in parentheses. For example, the code in (a) below is wrong. It should be corrected, as shown in (b).

why if statement?

if statement

flowchart

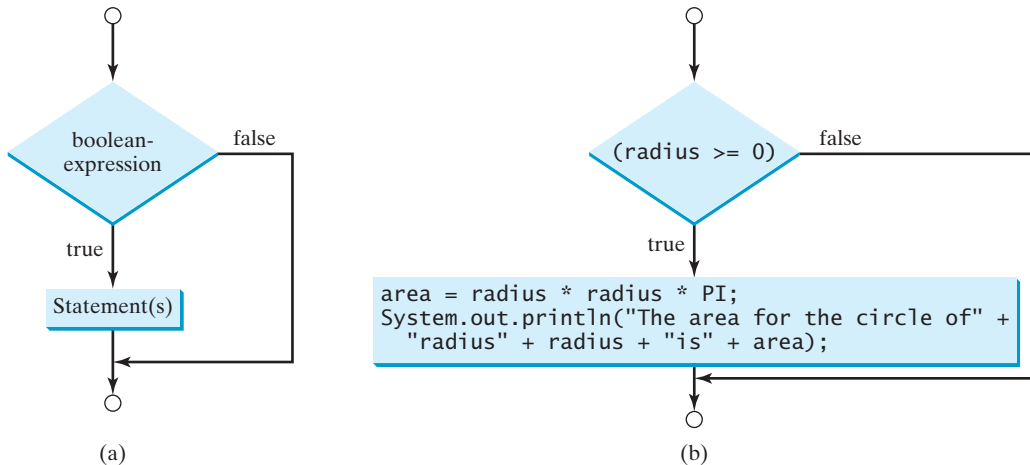


FIGURE 3.1 An `if` statement executes statements if the `boolean-expression` evaluates to `true`.

<pre>if i > 0 { System.out.println("i is positive"); }</pre>	<pre>if (i > 0) { System.out.println("i is positive"); }</pre>
(a) Wrong	(b) Correct

The block braces can be omitted if they enclose a single statement. For example, the following statements are equivalent.

<pre>if (i > 0) { System.out.println("i is positive"); }</pre>	<u>Equivalent</u>	<pre>if (i > 0) System.out.println("i is positive");</pre>
(a)		(b)



Note

Omitting braces makes the code shorter, but it is prone to errors. It is a common mistake to forget the braces when you go back to modify the code that omits the braces.

Omitting braces or not

Listing 3.2 gives a program that prompts the user to enter an integer. If the number is a multiple of 5, the program displays **HiFive**. If the number is divisible by 2, it displays **HiEven**.

LISTING 3.2 SimpleIfDemo.java

```

1  import java.util.Scanner;
2
3  public class SimpleIfDemo {
4      public static void main(String[] args) {
5          Scanner input = new Scanner(System.in);
6          System.out.println("Enter an integer: ");
7          int number = input.nextInt();           enter input
8
9          if (number % 5 == 0)                   check 5
10             System.out.println("HiFive");
11
12         if (number % 2 == 0)                   check even
13             System.out.println("HiEven");
14     }
15 }
```



```
Enter an integer: 4 [Enter]
HiEven
```



```
Enter an integer: 30 [Enter]
HiFive
HiEven
```

The program prompts the user to enter an integer (lines 6–7) and displays **HiFive** if it is divisible by 5 (lines 9–10) and **HiEven** if it is divisible by 2 (lines 12–13).



3.4 Write an **if** statement that assigns **1** to **x** if **y** is greater than **0**.

3.5 Write an **if** statement that increases pay by 3% if **score** is greater than **90**.

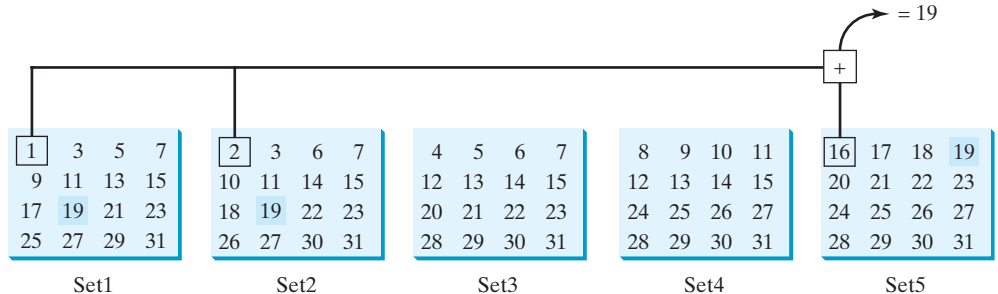
MyProgrammingLab™

3.4 Case Study: Guessing Birthdays



Guessing birthdays is an interesting problem with a simple programming solution.

You can find out the date of the month when your friend was born by asking five questions. Each question asks whether the day is in one of the five sets of numbers.



The birthday is the sum of the first numbers in the sets where the day appears. For example, if the birthday is **19**, it appears in Set1, Set2, and Set5. The first numbers in these three sets are **1**, **2**, and **16**. Their sum is **19**.

Listing 3.3 gives a program that prompts the user to answer whether the day is in Set1 (lines 41–44), in Set2 (lines 50–53), in Set3 (lines 59–62), in Set4 (lines 68–71), and in Set5 (lines 77–80). If the number is in the set, the program adds the first number in the set to **day** (lines 47, 56, 65, 74, 83).

LISTING 3.3 GuessBirthday.java

```
1 import java.util.Scanner;
2
3 public class GuessBirthday {
4     public static void main(String[] args) {
5         String set1 =
6             " 1 3 5 7\n" +
```



```

67 // Prompt the user to answer questions
68 System.out.print("\nIs your birthday in Set4?\n");
69 System.out.print(set4);
70 System.out.print("\nEnter 0 for No and 1 for Yes: ");
71 answer = input.nextInt();
72
in Set4? 73 if (answer == 1)
74     day += 8;
75
76 // Prompt the user to answer questions
77 System.out.print("\nIs your birthday in Set5?\n");
78 System.out.print(set5);
79 System.out.print("\nEnter 0 for No and 1 for Yes: ");
80 answer = input.nextInt();
81
in Set5? 82 if (answer == 1)
83     day += 16;
84
85 System.out.println("\nYour birthday is " + day + "!");
86 }
87 }

```



```

Is your birthday in Set1?
 1  3  5  7
 9 11 13 15
17 19 21 23
25 27 29 31
Enter 0 for No and 1 for Yes: 1 ↵Enter

Is your birthday in Set2?
 2  3  6  7
10 11 14 15
18 19 22 23
26 27 30 31
Enter 0 for No and 1 for Yes: 1 ↵Enter

Is your birthday in Set3?
 4  5  6  7
12 13 14 15
20 21 22 23
28 29 30 31
Enter 0 for No and 1 for Yes: 0 ↵Enter

Is your birthday in Set4?
 8  9 10 11
12 13 14 15
24 25 26 27
28 29 30 31
Enter 0 for No and 1 for Yes: 0 ↵Enter

Is your birthday in Set5?
16 17 18 19
20 21 22 23
24 25 26 27
28 29 30 31
Enter 0 for No and 1 for Yes: 1 ↵Enter
Your birthday is 19!

```



line#	day	answer	output
35	0		
44		1	
47	1		
53		1	
56	3		
62		0	
71		0	
80		1	
83	19		
85			Your birthday is 19!

This game is easy to program. You may wonder how the game was created. The mathematics behind the game is actually quite simple. The numbers are not grouped together by accident—the way they are placed in the five sets is deliberate. The starting numbers in the five sets are **1**, **2**, **4**, **8**, and **16**, which correspond to **1**, **10**, **100**, **1000**, and **10000** in binary (binary numbers are introduced in Appendix F, Number Systems). A binary number for decimal integers between **1** and **31** has at most five digits, as shown in Figure 3.2a. Let it be $b_5b_4b_3b_2b_1$. Thus, $b_5b_4b_3b_2b_1 = b_50000 + b_4000 + b_300 + b_20 + b_1$, as shown in Figure 3.2b. If a day's binary number has a digit **1** in b_k , the number should appear in Set k . For example, number **19** is binary **10011**, so it appears in Set1, Set2, and Set5. It is binary **1 + 10 + 10000 = 10011** or decimal **1 + 2 + 16 = 19**. Number **31** is binary **11111**, so it appears in Set1, Set2, Set3, Set4, and Set5. It is binary **1 + 10 + 100 + 1000 + 10000 = 11111** or decimal **1 + 2 + 4 + 8 + 16 = 31**.

mathematics behind the game

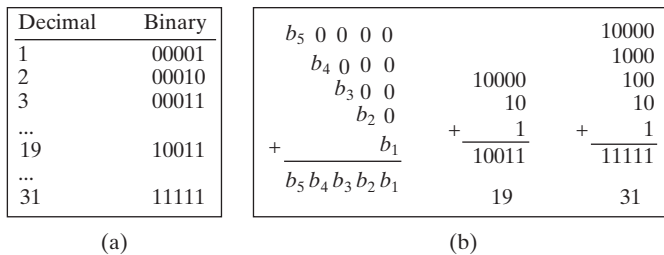


FIGURE 3.2 (a) A number between **1** and **31** can be represented using a 5-digit binary number. (b) A 5-digit binary number can be obtained by adding binary numbers **1**, **10**, **100**, **1000**, or **10000**.

3.5 Two-Way **if-else** Statements

An **if-else** statement decides which statements to execute based on whether the condition is true or false.



A one-way **if** statement takes an action if the specified condition is **true**. If the condition is **false**, nothing is done. But what if you want to take alternative actions when the condition is **false**? You can use a two-way **if-else** statement. The actions that a two-way **if-else** statement specifies differ based on whether the condition is **true** or **false**.

Here is the syntax for a two-way **if-else** statement:

```
if (boolean-expression) {
    statement(s)-for-the-true-case;
}
else {
    statement(s)-for-the-false-case;
}
```

The flowchart of the statement is shown in Figure 3.3.

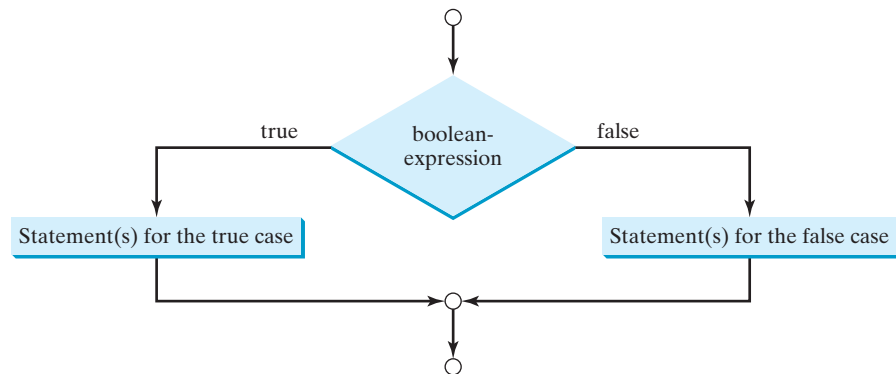


FIGURE 3.3 An **if-else** statement executes statements for the true case if the **Boolean-expression** evaluates to **true**; otherwise, statements for the false case are executed.

If the **boolean-expression** evaluates to **true**, the statement(s) for the true case are executed; otherwise, the statement(s) for the false case are executed. For example, consider the following code:

two-way if-else statement

```
if (radius >= 0) {
    area = radius * radius * PI;
    System.out.println("The area for the circle of radius " +
        radius + " is " + area);
}
else {
    System.out.println("Negative input");
}
```

If **radius >= 0** is **true**, **area** is computed and displayed; if it is **false**, the message **"Negative input"** is displayed.

As usual, the braces can be omitted if there is only one statement within them. The braces enclosing the **System.out.println("Negative input")** statement can therefore be omitted in the preceding example.

Here is another example of using the **if-else** statement. The example checks whether a number is even or odd, as follows:

```
if (number % 2 == 0)
    System.out.println(number + " is even.");
else
    System.out.println(number + " is odd.");
```

- 3.6** Write an **if** statement that increases **pay** by 3% if **score** is greater than 90, otherwise increases **pay** by 1%.
- 3.7** What is the printout of the code in (a) and (b) if **number** is 30? What if **number** is 35?



MyProgrammingLab™

```
if (number % 2 == 0)
    System.out.println(number + " is even.");

System.out.println(number + " is odd.");
```

(a)

```
if (number % 2 == 0)
    System.out.println(number + " is even.");
else
    System.out.println(number + " is odd.");
```

(b)

3.6 Nested **if** and Multi-Way **if-else** Statements

An **if** statement can be inside another **if** statement to form a nested **if** statement.



The statement in an **if** or **if-else** statement can be any legal Java statement, including another **if** or **if-else** statement. The inner **if** statement is said to be *nested* inside the outer **if** statement. The inner **if** statement can contain another **if** statement; in fact, there is no limit to the depth of the nesting. For example, the following is a nested **if** statement:

nested if statement

```
if (i > k) {
    if (j > k)
        System.out.println("i and j are greater than k");
}
else
    System.out.println("i is less than or equal to k");
```

The **if (j > k)** statement is nested inside the **if (i > k)** statement.

The nested **if** statement can be used to implement multiple alternatives. The statement given in Figure 3.4a, for instance, assigns a letter grade to the variable **grade** according to the score, with multiple alternatives.

```
if (score >= 90.0)
    grade = 'A';
else
    if (score >= 80.0)
        grade = 'B';
    else
        if (score >= 70.0)
            grade = 'C';
        else
            if (score >= 60.0)
                grade = 'D';
            else
                grade = 'F';
```

(a)

Equivalent

This is better

```
if (score >= 90.0)
    grade = 'A';
else if (score >= 80.0)
    grade = 'B';
else if (score >= 70.0)
    grade = 'C';
else if (score >= 60.0)
    grade = 'D';
else
    grade = 'F';
```

(b)

FIGURE 3.4 A preferred format for multiple alternatives is shown in (b) using a multi-way **if-else** statement.

The execution of this **if** statement proceeds as shown in Figure 3.5. The first condition (**score >= 90.0**) is tested. If it is **true**, the grade becomes **A**. If it is **false**, the second condition (**score >= 80.0**) is tested. If the second condition is **true**, the grade becomes **B**. If that condition is **false**, the third condition and the rest of the conditions (if necessary) are tested until a condition is met or all of the conditions prove to be **false**. If all of the conditions are **false**, the grade becomes **F**. Note that a condition is tested only when all of the conditions that come before it are **false**.

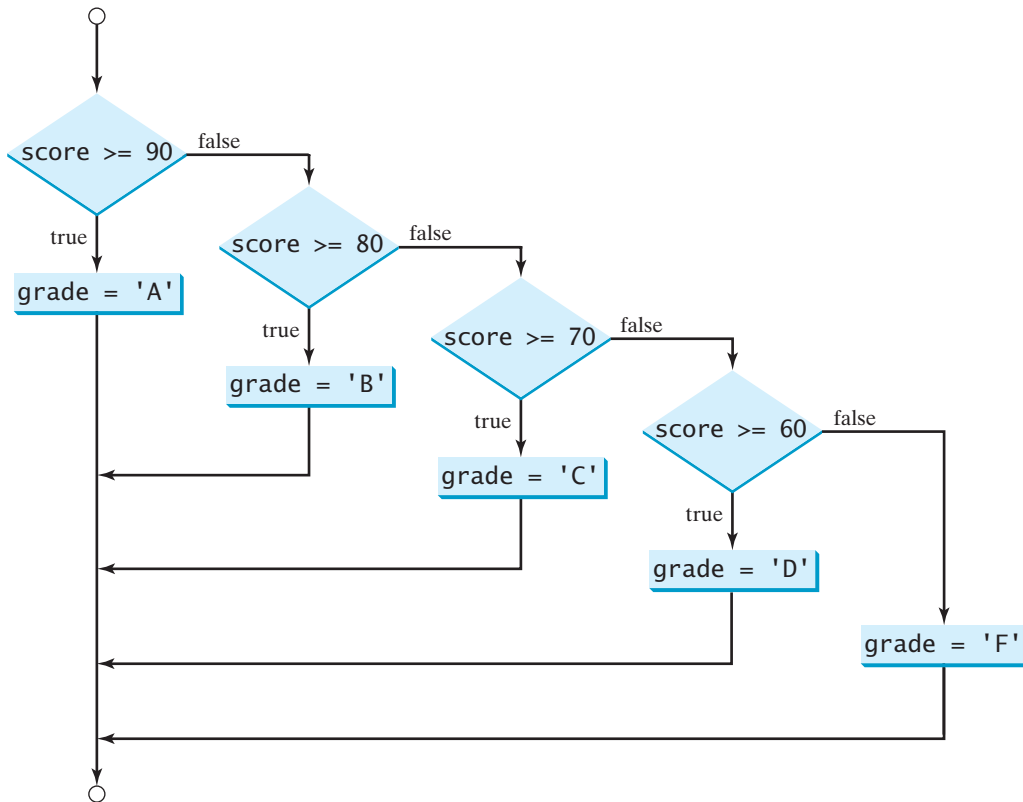


FIGURE 3.5 You can use a multi-way **if-else** statement to assign a grade.

The **if** statement in Figure 3.4a is equivalent to the **if** statement in Figure 3.4b. In fact, Figure 3.4b is the preferred coding style for multiple alternative **if** statements. This style, called *multi-way if-else statements*, avoids deep indentation and makes the program easy to read.

multi-way if statement



MyProgrammingLab™

- 3.8** Suppose $x = 3$ and $y = 2$; show the output, if any, of the following code. What is the output if $x = 3$ and $y = 4$? What is the output if $x = 2$ and $y = 2$? Draw a flowchart of the code.

```

if (x > 2) {
    if (y > 2) {
        z = x + y;
        System.out.println("z is " + z);
    }
}
else
    System.out.println("x is " + x);
  
```

- 3.9** Suppose $x = 2$ and $y = 3$. Show the output, if any, of the following code. What is the output if $x = 3$ and $y = 2$? What is the output if $x = 3$ and $y = 3$? (*Hint*: Indent the statement correctly first.)

```

if (x > 2)
    if (y > 2) {
        int z = x + y;
        System.out.println("z is " + z);
    }
else
    System.out.println("x is " + x);
  
```


3.10 What is wrong in the following code?

```

if (score >= 60.0)
    grade = 'D';
else if (score >= 70.0)
    grade = 'C';
else if (score >= 80.0)
    grade = 'B';
else if (score >= 90.0)
    grade = 'A';
else
    grade = 'F';

```

3.7 Common Errors in Selection Statements

Forgetting necessary braces, ending an `if` statement in the wrong place, mistaking `==` for `=`, and dangling `else` clauses are common errors in selection statements.



The following errors are common among new programmers.

Common Error 1: Forgetting Necessary Braces

The braces can be omitted if the block contains a single statement. However, forgetting the braces when they are needed for grouping multiple statements is a common programming error. If you modify the code by adding new statements in an `if` statement without braces, you will have to insert the braces. For example, the following code in (a) is wrong. It should be written with braces to group multiple statements, as shown in (b).

```

if (radius >= 0)
    area = radius * radius * PI;
    System.out.println("The area "
        + " is " + area);

```

(a) Wrong

```

if (radius >= 0) {
    area = radius * radius * PI;
    System.out.println("The area "
        + " is " + area);
}

```

(b) Correct

Common Error 2: Wrong Semicolon at the `if` Line

Adding a semicolon at the end of an `if` line, as shown in (a) below, is a common mistake.

Logic error

```

if (radius >= 0);
{
    area = radius * radius * PI;
    System.out.println("The area "
        + " is " + area);
}

```

(a)

Equivalent

Empty block

```

if (radius >= 0) {};
{
    area = radius * radius * PI;
    System.out.println("The area "
        + " is " + area);
}

```

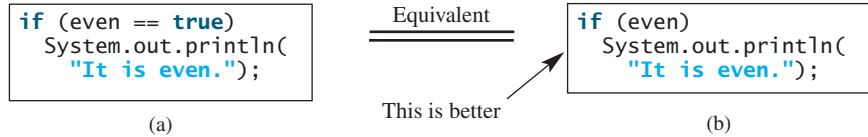
(b)

This mistake is hard to find, because it is neither a compile error nor a runtime error; it is a logic error. The code in (a) is equivalent to that in (b) with an empty block.

This error often occurs when you use the next-line block style. Using the end-of-line block style can help prevent this error.

Common Error 3: Redundant Testing of Boolean Values

To test whether a **boolean** variable is **true** or **false** in a test condition, it is redundant to use the equality comparison operator like the code in (a):



Instead, it is better to test the **boolean** variable directly, as shown in (b). Another good reason for doing this is to avoid errors that are difficult to detect. Using the **=** operator instead of the **==** operator to compare the equality of two items in a test condition is a common error. It could lead to the following erroneous statement:

```

if (even = true)
    System.out.println("It is even.");

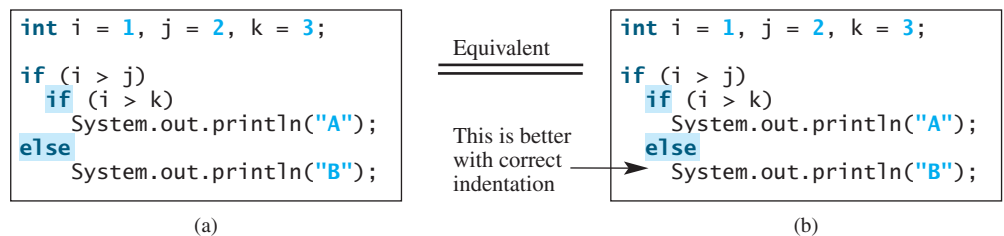
```

This statement does not have compile errors. It assigns **true** to **even**, so that **even** is always **true**.

Common Error 4: Dangling else Ambiguity

The code in (a) below has two **if** clauses and one **else** clause. Which **if** clause is matched by the **else** clause? The indentation indicates that the **else** clause matches the first **if** clause. However, the **else** clause actually matches the second **if** clause. This situation is known as the *dangling else ambiguity*. The **else** clause always matches the most recent unmatched **if** clause in the same block. So, the statement in (a) is equivalent to the code in (b).

dangling else ambiguity



Since **(i > j)** is false, nothing is displayed from the statements in (a) and (b). To force the **else** clause to match the first **if** clause, you must add a pair of braces:

```

int i = 1, j = 2, k = 3;

if (i > j) {
    if (i > k)
        System.out.println("A");
}
else
    System.out.println("B");

```

This statement displays **B**.

**Tip**

Often new programmers write the code that assigns a test condition to a **boolean** variable like the code in (a):

assign boolean variable

```
if (number % 2 == 0)
    even = true;
else
    even = false;
```

(a)

Equivalent

=====

This is shorter

```
boolean even
    = number % 2 == 0;
```

(b)

The code can be simplified by assigning the test value directly to the variable, as shown in (b).

3.11 Which of the following statements are equivalent? Which ones are correctly indented?



MyProgrammingLab™

```
if (i > 0) if
(j > 0)
x = 0; else
if (k > 0) y = 0;
else z = 0;
```

(a)

```
if (i > 0) {
    if (j > 0)
        x = 0;
    else if (k > 0)
        y = 0;
}
else
    z = 0;
```

(b)

```
if (i > 0)
    if (j > 0)
        x = 0;
    else if (k > 0)
        y = 0;
    else
        z = 0;
```

(c)

```
if (i > 0)
    if (j > 0)
        x = 0;
    else if (k > 0)
        y = 0;
else
    z = 0;
```

(d)

3.12 Rewrite the following statement using a Boolean expression:

```
if (count % 10 == 0)
    newLine = true;
else
    newLine = false;
```

3.13 Are the following statements correct? Which one is better?

```
if (age < 16)
    System.out.println
        ("Cannot get a driver's license");
if (age >= 16)
    System.out.println
        ("Can get a driver's license");
```

(a)

```
if (age < 16)
    System.out.println
        ("Cannot get a driver's license");
else
    System.out.println
        ("Can get a driver's license");
```

(b)

3.14 What is the output of the following code if **number** is 14, 15, and 30?

```
if (number % 2 == 0)
    System.out.println
        (number + " is even");
if (number % 5 == 0)
    System.out.println
        (number + " is multiple of 5");
```

(a)

```
if (number % 2 == 0)
    System.out.println
        (number + " is even");
else if (number % 5 == 0)
    System.out.println
        (number + " is multiple of 5");
```

(b)

3.8 Generating Random Numbers



You can use `Math.random()` to obtain a random double value between `0.0` and `1.0`, excluding `1.0`.



VideoNote

Program subtraction quiz

random() method

Suppose you want to develop a program for a first-grader to practice subtraction. The program randomly generates two single-digit integers, `number1` and `number2`, with `number1 >= number2`, and it displays to the student a question such as “What is $9 - 2$?” After the student enters the answer, the program displays a message indicating whether it is correct.

The previous programs generate random numbers using `System.currentTimeMillis()`. A better approach is to use the `random()` method in the `Math` class. Invoking this method returns a random double value `d` such that $0.0 \leq d < 1.0$. Thus, `(int)(Math.random() * 10)` returns a random single-digit integer (i.e., a number between `0` and `9`).

The program can work as follows:

1. Generate two single-digit integers into `number1` and `number2`.
2. If `number1 < number2`, swap `number1` with `number2`.
3. Prompt the student to answer, “What is `number1 - number2`?”
4. Check the student’s answer and display whether the answer is correct.

The complete program is shown in Listing 3.4.

LISTING 3.4 SubtractionQuiz.java

```

1  import java.util.Scanner;
2
3  public class SubtractionQuiz {
4      public static void main(String[] args) {
5          // 1. Generate two random single-digit integers
6          int number1 = (int)(Math.random() * 10);
7          int number2 = (int)(Math.random() * 10);
8
9          // 2. If number1 < number2, swap number1 with number2
10         if (number1 < number2) {
11             int temp = number1;
12             number1 = number2;
13             number2 = temp;
14         }
15
16         // 3. Prompt the student to answer "What is number1 - number2?"
17         System.out.print
18             ("What is " + number1 + " - " + number2 + "? ");
19         Scanner input = new Scanner(System.in);
20         int answer = input.nextInt();
21
22         // 4. Grade the answer and display the result
23         if (number1 - number2 == answer)
24             System.out.println("You are correct!");
25         else
26             System.out.println("Your answer is wrong\n" + number1 + " - "
27                 + number2 + " is " + (number1 - number2));
28     }
29 }

```

random number

get answer

check the answer



What is 6 - 6? 0
You are correct!

What is 9 - 2? 5
 Your answer is wrong
 9 - 2 is 7



line#	number1	number2	temp	answer	output
6	2				
7		9			
11			2		
12	9				
13		2			
20				5	
26					Your answer is wrong 9 - 2 should be 7

To swap two variables `number1` and `number2`, a temporary variable `temp` (line 11) is used to first hold the value in `number1`. The value in `number2` is assigned to `number1` (line 12), and the value in `temp` is assigned to `number2` (line 13).

3.15 Which of the following is a possible output from invoking `Math.random()`?

`323.4`, `0.5`, `34`, `1.0`, `0.0`, `0.234`

- 3.16**
- How do you generate a random integer `i` such that $0 \leq i < 20$?
 - How do you generate a random integer `i` such that $10 \leq i < 20$?
 - How do you generate a random integer `i` such that $10 \leq i \leq 50$?



MyProgrammingLab™

3.9 Case Study: Computing Body Mass Index

You can use nested `if` statements to write a program that interprets body mass index.

Body Mass Index (BMI) is a measure of health based on height and weight. It can be calculated by taking your weight in kilograms and dividing it by the square of your height in meters. The interpretation of BMI for people 20 years or older is as follows:



BMI	Interpretation
Below 18.5	Underweight
18.5–24.9	Normal
25.0–29.9	Overweight
Above 30.0	Obese

Write a program that prompts the user to enter a weight in pounds and height in inches and displays the BMI. Note that one pound is `0.45359237` kilograms and one inch is `0.0254` meters. Listing 3.5 gives the program.

LISTING 3.5 ComputeAndInterpretBMI.java

```

1  import java.util.Scanner;
2
3  public class ComputeAndInterpretBMI {
4      public static void main(String[] args) {
5          Scanner input = new Scanner(System.in);
6
7          // Prompt the user to enter weight in pounds
8          System.out.print("Enter weight in pounds: ");
input weight 9          double weight = input.nextDouble();
10
11         // Prompt the user to enter height in inches
input height 12         System.out.print("Enter height in inches: ");
13         double height = input.nextDouble();
14
15         final double KILOGRAMS_PER_POUND = 0.45359237; // Constant
16         final double METERS_PER_INCH = 0.0254; // Constant
17
18         // Compute BMI
compute bmi 19         double weightInKilograms = weight * KILOGRAMS_PER_POUND;
20         double heightInMeters = height * METERS_PER_INCH;
21         double bmi = weightInKilograms /
22             (heightInMeters * heightInMeters);
23
24         // Display result
display output 25         System.out.println("BMI is " + bmi);
26         if (bmi < 18.5)
27             System.out.println("Underweight");
28         else if (bmi < 25)
29             System.out.println("Normal");
30         else if (bmi < 30)
31             System.out.println("Overweight");
32         else
33             System.out.println("Obese");
34     }
35 }

```



```

Enter weight in pounds: 146 ↵
Enter height in inches: 70 ↵
BMI is 20.948603801493316
Normal

```



line#	weight	height	weightInKilograms	heightInMeters	bmi	output
9	146					
13		70				
19			66.22448602			
20				1.778		
21					20.9486	
25						BMI is 20.95
31						Normal

The constants `KILOGRAMS_PER_POUND` and `METERS_PER_INCH` are defined in lines 15–16. Using constants here makes programs easy to read.

3.10 Case Study: Computing Taxes

You can use nested `if` statements to write a program for computing taxes.

The United States federal personal income tax is calculated based on filing status and taxable income. There are four filing statuses: single filers, married filing jointly or qualified widow(er), married filing separately, and head of household. The tax rates vary every year. Table 3.2 shows the rates for 2009. If you are, say, single with a taxable income of \$10,000, the first \$8,350 is taxed at 10% and the other \$1,650 is taxed at 15%, so, your total tax is \$1,082.50.



VideoNote

Use multi-way `if-else` statements

TABLE 3.2 2009 U.S. Federal Personal Tax Rates

Marginal Tax Rate	Single	Married Filing Jointly or Qualifying Widow(er)	Married Filing Separately	Head of Household
10%	\$0 – \$8,350	\$0 – \$16,700	\$0 – \$8,350	\$0 – \$11,950
15%	\$8,351 – \$33,950	\$16,701 – \$67,900	\$8,351 – \$33,950	\$11,951 – \$45,500
25%	\$33,951 – \$82,250	\$67,901 – \$137,050	\$33,951 – \$68,525	\$45,501 – \$117,450
28%	\$82,251 – \$171,550	\$137,051 – \$208,850	\$68,526 – \$104,425	\$117,451 – \$190,200
33%	\$171,551 – \$372,950	\$208,851 – \$372,950	\$104,426 – \$186,475	\$190,201 – \$372,950
35%	\$372,951 +	\$372,951 +	\$186,476 +	\$372,951 +

You are to write a program to compute personal income tax. Your program should prompt the user to enter the filing status and taxable income and compute the tax. Enter **0** for single filers, **1** for married filing jointly or qualified widow(er), **2** for married filing separately, and **3** for head of household.

Your program computes the tax for the taxable income based on the filing status. The filing status can be determined using `if` statements outlined as follows:

```

if (status == 0) {
    // Compute tax for single filers
}
else if (status == 1) {
    // Compute tax for married filing jointly or qualifying widow(er)
}
else if (status == 2) {
    // Compute tax for married filing separately
}
else if (status == 3) {
    // Compute tax for head of household
}
else {
    // Display wrong status
}

```

For each filing status there are six tax rates. Each rate is applied to a certain amount of taxable income. For example, of a taxable income of \$400,000 for single filers, \$8,350 is taxed at 10%, (\$33,950 – \$8,350) at 15%, (\$82,250 – \$33,950) at 25%, (\$171,550 – \$82,250) at 28%, (\$372,950 – \$171,550) at 33%, and (\$400,000 – \$372,950) at 35%.

Listing 3.6 gives the solution for computing taxes for single filers. The complete solution is left as an exercise.

LISTING 3.6 ComputeTax.java

```

1  import java.util.Scanner;
2
3  public class ComputeTax {
4      public static void main(String[] args) {
5          // Create a Scanner
6          Scanner input = new Scanner(System.in);
7
8          // Prompt the user to enter filing status
9          System.out.print(
10             "(0-single filer, 1-married jointly or qualifying widow(er),
11             + "\n2-married separately, 3-head of household)\n" +
12             "Enter the filing status: ");
input status
13         int status = input.nextInt();
14
15         // Prompt the user to enter taxable income
16         System.out.print("Enter the taxable income: ");
input income
17         double income = input.nextDouble();
18
19         // Compute tax
20         double tax = 0;
compute tax
21
22         if (status == 0) { // Compute tax for single filers
23             if (income <= 8350)
24                 tax = income * 0.10;
25             else if (income <= 33950)
26                 tax = 8350 * 0.10 + (income - 8350) * 0.15;
27             else if (income <= 82250)
28                 tax = 8350 * 0.10 + (33950 - 8350) * 0.15 +
29                 (income - 33950) * 0.25;
30             else if (income <= 171550)
31                 tax = 8350 * 0.10 + (33950 - 8350) * 0.15 +
32                 (82250 - 33950) * 0.25 + (income - 82250) * 0.28;
33             else if (income <= 372950)
34                 tax = 8350 * 0.10 + (33950 - 8350) * 0.15 +
35                 (82250 - 33950) * 0.25 + (171550 - 82250) * 0.28 +
36                 (income - 171550) * 0.33;
37             else
38                 tax = 8350 * 0.10 + (33950 - 8350) * 0.15 +
39                 (82250 - 33950) * 0.25 + (171550 - 82250) * 0.28 +
40                 (372950 - 171550) * 0.33 + (income - 372950) * 0.35;
41         }
42         else if (status == 1) { // Left as exercise
43             // Compute tax for married file jointly or qualifying widow(er)
44         }
45         else if (status == 2) { // Compute tax for married separately
46             // Left as exercise
47         }
48         else if (status == 3) { // Compute tax for head of household
49             // Left as exercise
50         }
51         else {
52             System.out.println("Error: invalid status");
53             System.exit(1);
54         }
55
56         // Display the result
57         System.out.println("Tax is " + (int)(tax * 100) / 100.0);
58     }
59 }
exit program
display output

```




```
(0-single filer, 1-married jointly or qualifying widow(er),
2-married separately, 3-head of household)
Enter the filing status: 0 [Enter]
Enter the taxable income: 400000 [Enter]
Tax is 117683.5
```



line#	status	income	tax	output
13	0			
17		400000		
20			0	
38			117683.5	
57				Tax is 117683.5

The program receives the filing status and taxable income. The multi-way **if-else** statements (lines 22, 42, 45, 48, 51) check the filing status and compute the tax based on the filing status.

System.exit(status) (line 53) is defined in the **System** class. Invoking this method terminates the program. The status **0** indicates that the program is terminated normally. A nonzero status code indicates abnormal termination.

System.exit(status)

An initial value of **0** is assigned to **tax** (line 20). A compile error would occur if it had no initial value, because all of the other statements that assign values to **tax** are within the **if** statement. The compiler thinks that these statements may not be executed and therefore reports a compile error.

To test a program, you should provide the input that covers all cases. For this program, your input should cover all statuses (**0, 1, 2, 3**). For each status, test the tax for each of the six brackets. So, there are a total of 24 cases.

test all cases



Tip

For all programs, you should write a small amount of code and test it before moving on to add more code. This is called *incremental development and testing*. This approach makes testing easier, because the errors are likely in the new code you just added.

incremental development and testing

3.17 Are the following two statements equivalent?



MyProgrammingLab™

```
if (income <= 10000)
    tax = income * 0.1;
else if (income <= 20000)
    tax = 1000 +
        (income - 10000) * 0.15;
```

```
if (income <= 10000)
    tax = income * 0.1;
else if (income > 10000 &&
        income <= 20000)
    tax = 1000 +
        (income - 10000) * 0.15;
```

3.11 Logical Operators

The logical operators **!**, **&&**, **||**, and **^** can be used to create a compound Boolean expression.



Sometimes, whether a statement is executed is determined by a combination of several conditions. You can use logical operators to combine these conditions to form a compound Boolean expression. *Logical operators*, also known as *Boolean operators*, operate on Boolean values

to create a new Boolean value. Table 3.3 lists the Boolean operators. Table 3.4 defines the not (!) operator, which negates **true** to **false** and **false** to **true**. Table 3.5 defines the and (&&) operator. The and (&&) of two Boolean operands is **true** if and only if both operands are **true**. Table 3.6 defines the or (||) operator. The or (||) of two Boolean operands is **true** if at least one of the operands is **true**. Table 3.7 defines the exclusive or (^) operator. The exclusive or (^) of two Boolean operands is **true** if and only if the two operands have different Boolean values. Note that $p1 \wedge p2$ is the same as $p1 \neq p2$.

TABLE 3.3 Boolean Operators

Operator	Name	Description
!	not	logical negation
&&	and	logical conjunction
	or	logical disjunction
^	exclusive or	logical exclusion

TABLE 3.4 Truth Table for Operator !

p	!p	Example (assume age = 24, gender = 'F')
true	false	!(age > 18) is false, because (age > 18) is true.
false	true	!(gender == 'M') is true, because (gender == 'M') is false.

TABLE 3.5 Truth Table for Operator &&

p ₁	p ₂	p ₁ && p ₂	Example (assume age = 24, gender = 'F')
false	false	false	(age > 18) && (gender == 'F') is true, because (age > 18) and (gender == 'F') are both true.
false	true	false	
true	false	false	(age > 18) && (gender != 'F') is false, because (gender != 'F') is false.
true	true	true	

TABLE 3.6 Truth Table for Operator ||

p ₁	p ₂	p ₁ p ₂	Example (assume age = 24, gender = 'F')
false	false	false	(age > 34) (gender == 'F') is true, because (gender == 'F') is true.
false	true	true	
true	false	true	(age > 34) (gender == 'M') is false, because (age > 34) and (gender == 'M') are both false.
true	true	true	

TABLE 3.7 Truth Table for Operator \wedge

p_1	p_2	$p_1 \wedge p_2$	Example (assume age = 24, gender = 'F')
false	false	false	$(\text{age} > 34) \wedge (\text{gender} == \text{'F'})$ is true , because $(\text{age} > 34)$ is false but $(\text{gender} == \text{'F'})$ is true .
false	true	true	
true	false	true	$(\text{age} > 34) \wedge (\text{gender} == \text{'M'})$ is false , because $(\text{age} > 34)$ and $(\text{gender} == \text{'M'})$ are both false .
true	true	false	

Listing 3.7 gives a program that checks whether a number is divisible by 2 and 3, by 2 or 3, and by 2 or 3 but not both:

LISTING 3.7 TestBooleanOperators.java

```

1  import java.util.Scanner;
2
3  public class TestBooleanOperators {
4      public static void main(String[] args) {
5          // Create a Scanner
6          Scanner input = new Scanner(System.in);
7
8          // Receive an input
9          System.out.print("Enter an integer: ");
10         int number = input.nextInt();
11
12         if (number % 2 == 0 && number % 3 == 0)
13             System.out.println(number + " is divisible by 2 and 3.");
14
15         if (number % 2 == 0 || number % 3 == 0)
16             System.out.println(number + " is divisible by 2 or 3.");
17
18         if (number % 2 == 0 ^ number % 3 == 0)
19             System.out.println(number +
20                 " is divisible by 2 or 3, but not both.");
21     }
22 }

```

import class

input

and

or

exclusive or

```

Enter an integer: 4
4 is divisible by 2 or 3.
4 is divisible by 2 or 3, but not both.

```



```

Enter an integer: 18
18 is divisible by 2 and 3.
18 is divisible by 2 or 3.

```



$(\text{number} \% 2 == 0 \ \&\& \ \text{number} \% 3 == 0)$ (line 12) checks whether the number is divisible by both 2 and 3. $(\text{number} \% 2 == 0 \ || \ \text{number} \% 3 == 0)$ (line 15) checks whether the number is divisible by 2 and/or by 3. $(\text{number} \% 2 == 0 \ \wedge \ \text{number} \% 3 == 0)$ (line 18) checks whether the number is divisible by 2 or 3, but not both.

**Caution**

In mathematics, the expression

$$1 \leq \text{numberOfDaysInAMonth} \leq 31$$

incompatible operands

is correct. However, it is incorrect in Java, because `1 <= numberOfDaysInAMonth` is evaluated to a `boolean` value, which cannot be compared with `31`. Here, two operands (a `boolean` value and a numeric value) are *incompatible*. The correct expression in Java is

```
(1 <= numberOfDaysInAMonth) && (numberOfDaysInAMonth <= 31)
```

cannot cast `boolean`**Note**

As shown in the preceding chapter, a `char` value can be cast into an `int` value, and vice versa. A `boolean` value, however, cannot be cast into a value of another type, nor can a value of another type be cast into a `boolean` value.

De Morgan's law

**Note**

De Morgan's law, named after Indian-born British mathematician and logician Augustus De Morgan (1806–1871), can be used to simplify Boolean expressions. The law states:

```
!(condition1 && condition2) is the same as
!condition1 || !condition2
!(condition1 || condition2) is the same as
!condition1 && !condition2
```

For example,

```
!(number % 2 == 0 && number % 3 == 0)
```

can be simplified using an equivalent expression:

```
(number % 2 != 0 || number % 3 != 0)
```

As another example,

```
!(number == 2 || number == 3)
```

is better written as

```
number != 2 && number != 3
```

conditional operator
short-circuit operator

If one of the operands of an `&&` operator is `false`, the expression is `false`; if one of the operands of an `||` operator is `true`, the expression is `true`. Java uses these properties to improve the performance of these operators. When evaluating `p1 && p2`, Java first evaluates `p1` and then, if `p1` is `true`, evaluates `p2`; if `p1` is `false`, it does not evaluate `p2`. When evaluating `p1 || p2`, Java first evaluates `p1` and then, if `p1` is `false`, evaluates `p2`; if `p1` is `true`, it does not evaluate `p2`. Therefore, `&&` is referred to as the *conditional* or *short-circuit AND* operator, and `||` is referred to as the *conditional* or *short-circuit OR* operator. Java also provides the conditional AND (`&`) and OR (`|`) operators, which are covered in Supplement III.C and III.D for advanced readers.

**Check
Point**

MyProgrammingLab™

3.18 Assuming that `x` is `1`, show the result of the following Boolean expressions.

```
(true) && (3 > 4)
!(x > 0) && (x > 0)
(x > 0) || (x < 0)

(x != 0) || (x == 0)
(x >= 0) || (x < 0)
(x != 1) == !(x == 1)
```

3.19 Write a Boolean expression that evaluates to `true` if a number stored in variable `num` is between `1` and `100`.

3.20 Write a Boolean expression that evaluates to `true` if a number stored in variable `num` is between `1` and `100` or the number is negative.

3.21 Assume that **x** and **y** are **int** type. Which of the following are legal Java expressions?

```
x > y > 0
x = y && y
x /= y
x or y
x and y
(x != 0) || (x = 0)
```

3.22 Suppose that **x** is **1**. What is **x** after the evaluation of the following expression?

- `(x >= 1) && (x++ > 1)`
- `(x > 1) && (x++ > 1)`

3.23 What is the value of the expression `ch >= 'A' && ch <= 'Z'` if **ch** is 'A', 'p', 'E', or '5'?

3.24 Suppose, when you run the program, you enter input `2 3 6` from the console. What is the output?

```
public class Test {
    public static void main(String[] args) {
        java.util.Scanner input = new java.util.Scanner(System.in);
        double x = input.nextDouble();
        double y = input.nextDouble();
        double z = input.nextDouble();

        System.out.println("(x < y && y < z) is " + (x < y && y < z));
        System.out.println("(x < y || y < z) is " + (x < y || y < z));
        System.out.println("! (x < y) is " + !(x < y));
        System.out.println("(x + y < z) is " + (x + y < z));
        System.out.println("(x + y < z) is " + (x + y < z));
    }
}
```

3.25 Write a Boolean expression that evaluates **true** if **age** is greater than **13** and less than **18**.

3.26 Write a Boolean expression that evaluates **true** if **weight** is greater than **50** pounds or height is greater than **60** inches.

3.27 Write a Boolean expression that evaluates **true** if **weight** is greater than **50** pounds and height is greater than **60** inches.

3.28 Write a Boolean expression that evaluates **true** if either **weight** is greater than **50** pounds or height is greater than **60** inches, but not both.

3.12 Case Study: Determining Leap Year

A year is a leap year if it is divisible by 4 but not by 100, or if it is divisible by 400.

You can use the following Boolean expressions to check whether a year is a leap year:

```
// A leap year is divisible by 4
boolean isLeapYear = (year % 4 == 0);

// A leap year is divisible by 4 but not by 100
isLeapYear = isLeapYear && (year % 100 != 0);

// A leap year is divisible by 4 but not by 100 or divisible by 400
isLeapYear = isLeapYear || (year % 400 == 0);
```

Or you can combine all these expressions into one like this:

```
isLeapYear = (year % 4 == 0 && year % 100 != 0) || (year % 400 == 0);
```



Listing 3.8 gives the program that lets the user enter a year and checks whether it is a leap year.

LISTING 3.8 LeapYear.java

```

1  import java.util.Scanner;
2
3  public class LeapYear {
4      public static void main(String[] args) {
5          // Create a Scanner
6          Scanner input = new Scanner(System.in);
7          System.out.print("Enter a year: ");
8          int year = input.nextInt();
9
10         // Check if the year is a leap year
11         boolean isLeapYear =
12             (year % 4 == 0 && year % 100 != 0) || (year % 400 == 0);
13
14         // Display the result
15         System.out.println(year + " is a leap year? " + isLeapYear);
16     }
17 }

```

input

leap year?

display result



Enter a year: 2012 Enter
2008 is a leap year? true



Enter a year: 1900 Enter
1900 is a leap year? false



Enter a year: 2002 Enter
2002 is a leap year? false

3.13 Case Study: Lottery



The lottery program involves generating random numbers, comparing digits, and using Boolean operators.

Suppose you want to develop a program to play lottery. The program randomly generates a lottery of a two-digit number, prompts the user to enter a two-digit number, and determines whether the user wins according to the following rules:

1. If the user input matches the lottery number in the exact order, the award is \$10,000.
2. If all the digits in the user input match all the digits in the lottery number, the award is \$3,000.
3. If one digit in the user input matches a digit in the lottery number, the award is \$1,000.

The complete program is shown in Listing 3.9.

LISTING 3.9 Lottery.java

```

1  import java.util.Scanner;
2
3  public class Lottery {
4      public static void main(String[] args) {
5          // Generate a lottery number

```

```

6      int lottery = (int)(Math.random() * 100);
7
8      // Prompt the user to enter a guess
9      Scanner input = new Scanner(System.in);
10     System.out.print("Enter your lottery pick (two digits): ");
11     int guess = input.nextInt();
12
13     // Get digits from lottery
14     int lotteryDigit1 = lottery / 10;
15     int lotteryDigit2 = lottery % 10;
16
17     // Get digits from guess
18     int guessDigit1 = guess / 10;
19     int guessDigit2 = guess % 10;
20
21     System.out.println("The lottery number is " + lottery);
22
23     // Check the guess
24     if (guess == lottery)
25         System.out.println("Exact match: you win $10,000");
26     else if (guessDigit2 == lotteryDigit1
27             && guessDigit1 == lotteryDigit2)
28         System.out.println("Match all digits: you win $3,000");
29     else if (guessDigit1 == lotteryDigit1
30             || guessDigit1 == lotteryDigit2
31             || guessDigit2 == lotteryDigit1
32             || guessDigit2 == lotteryDigit2)
33         System.out.println("Match one digit: you win $1,000");
34     else
35         System.out.println("Sorry, no match");
36 }
37 }

```

generate a lottery number

enter a guess

exact match?

match all digits?

match one digit?

```

Enter your lottery pick (two digits): 45 
The lottery number is 12
Sorry, no match

```



```

Enter your lottery pick: 23 
The lottery number is 34
Match one digit: you win $1,000

```



line#	6	11	14	15	18	19	33
variable							
lottery	34						
guess		23					
lotteryDigit1			3				
lotteryDigit2				4			
guessDigit1					2		
guessDigit2						3	
Output							Match one digit: you win \$1,000



The program generates a lottery using the `random()` method (line 6) and prompts the user to enter a guess (line 11). Note that `guess % 10` obtains the last digit from `guess` and `guess / 10` obtains the first digit from `guess`, since `guess` is a two-digit number (lines 18–19).

The program checks the guess against the lottery number in this order:

1. First, check whether the guess matches the lottery exactly (line 24).
2. If not, check whether the reversal of the guess matches the lottery (lines 26–27).
3. If not, check whether one digit is in the lottery (lines 29–32).
4. If not, nothing matches and display "Sorry, no match" (lines 34–35).

3.14 switch Statements



A **switch** statement executes statements based on the value of a variable or an expression.

The **if** statement in Listing 3.6, `ComputeTax.java`, makes selections based on a single **true** or **false** condition. There are four cases for computing taxes, which depend on the value of **status**. To fully account for all the cases, nested **if** statements were used. Overuse of nested **if** statements makes a program difficult to read. Java provides a **switch** statement to simplify coding for multiple conditions. You can write the following **switch** statement to replace the nested **if** statement in Listing 3.6:

```
switch (status) {
    case 0: compute tax for single filers;
           break;
    case 1: compute tax for married jointly or qualifying widow(er);
           break;
    case 2: compute tax for married filing separately;
           break;
    case 3: compute tax for head of household;
           break;
    default: System.out.println("Error: invalid status");
            System.exit(1);
}
```

The flowchart of the preceding **switch** statement is shown in Figure 3.6.

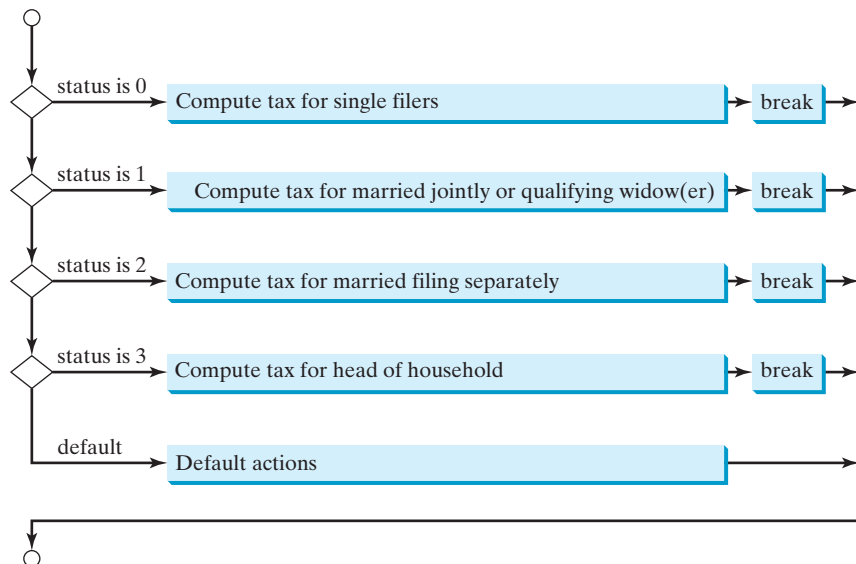


FIGURE 3.6 The **switch** statement checks all cases and executes the statements in the matched case.

This statement checks to see whether the status matches the value **0**, **1**, **2**, or **3**, in that order. If matched, the corresponding tax is computed; if not matched, a message is displayed. Here is the full syntax for the **switch** statement:

```
switch (switch-expression) {
    case value1: statement(s)1;
                break;
    case value2: statement(s)2;
                break;
    ...
    case valueN: statement(s)N;
                break;
    default:    statement(s)-for-default;
}
```

switch statement

The **switch** statement observes the following rules:

- The **switch-expression** must yield a value of **char**, **byte**, **short**, **int**, or **String** type and must always be enclosed in parentheses. (Using **String** type in the **switch** expression is new in JDK 7.)
- The **value1**, . . . , and **valueN** must have the same data type as the value of the **switch-expression**. Note that **value1**, . . . , and **valueN** are constant expressions, meaning that they cannot contain variables, such as **1 + x**.
- When the value in a **case** statement matches the value of the **switch-expression**, the statements *starting from this case* are executed until either a **break** statement or the end of the **switch** statement is reached.
- The **default** case, which is optional, can be used to perform actions when none of the specified cases matches the **switch-expression**.
- The keyword **break** is optional. The **break** statement immediately ends the **switch** statement.



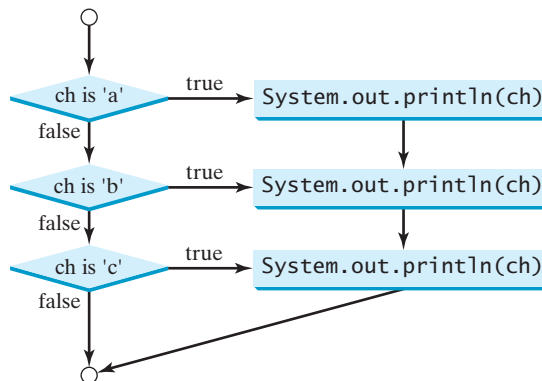
Caution

Do not forget to use a **break** statement when one is needed. Once a case is matched, the statements starting from the matched case are executed until a **break** statement or the end of the **switch** statement is reached. This is referred to as *fall-through* behavior. For example, the following code displays the character **a** three times if **ch** is **a**:

without break

fall-through behavior

```
switch (ch) {
    case 'a': System.out.println(ch);
    case 'b': System.out.println(ch);
    case 'c': System.out.println(ch);
}
```



Tip

To avoid programming errors and improve code maintainability, it is a good idea to put a comment in a case clause if **break** is purposely omitted.

Now let us write a program to find out the Chinese Zodiac sign for a given year. The Chinese Zodiac is based on a twelve-year cycle, with each year represented by an animal—monkey, rooster, dog, pig, rat, ox, tiger, rabbit, dragon, snake, horse, or sheep—in this cycle, as shown in Figure 3.7.

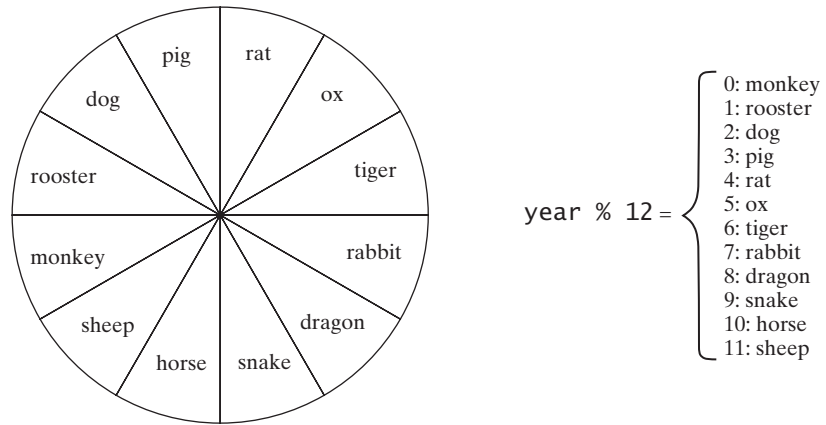


FIGURE 3.7 The Chinese Zodiac is based on a twelve-year cycle.

Note that `year % 12` determines the Zodiac sign. 1900 is the year of the rat because `1900 % 12` is 4. Listing 3.10 gives a program that prompts the user to enter a year and displays the animal for the year.

LISTING 3.10 ChineseZodiac.java

```

1  import java.util.Scanner;
2
3  public class ChineseZodiac {
4      public static void main(String[] args) {
5          Scanner input = new Scanner(System.in);
6
7          System.out.print("Enter a year: ");
8          int year = input.nextInt();
9
10         switch (year % 12) {
11             case 0: System.out.println("monkey"); break;
12             case 1: System.out.println("rooster"); break;
13             case 2: System.out.println("dog"); break;
14             case 3: System.out.println("pig"); break;
15             case 4: System.out.println("rat"); break;
16             case 5: System.out.println("ox"); break;
17             case 6: System.out.println("tiger"); break;
18             case 7: System.out.println("rabbit"); break;
19             case 8: System.out.println("dragon"); break;
20             case 9: System.out.println("snake"); break;
21             case 10: System.out.println("horse"); break;
22             case 11: System.out.println("sheep");
23         }
24     }
25 }

```

enter year

determine Zodiac sign



Enter a year: 1963
rabbit



Enter a year: 1877
 oX

3.29 What data types are required for a **switch** variable? If the keyword **break** is not used after a case is processed, what is the next statement to be executed? Can you convert a **switch** statement to an equivalent **if** statement, or vice versa? What are the advantages of using a **switch** statement?



MyProgrammingLab™

3.30 What is **y** after the following **switch** statement is executed? Rewrite the code using the **if-else** statement.

```
x = 3; y = 3;
switch (x + 3) {
    case 6: y = 1;
    default: y += 1;
}
```

3.31 What is **x** after the following **if-else** statement is executed? Use a **switch** statement to rewrite it and draw the flowchart for the new **switch** statement.

```
int x = 1, a = 3;
if (a == 1)
    x += 5;
else if (a == 2)
    x += 10;
else if (a == 3)
    x += 16;
else if (a == 4)
    x += 34;
```

3.32 Write a **switch** statement that assigns a **String** variable **dayName** with Sunday, Monday, Tuesday, Wednesday, Thursday, Friday, Saturday, if **day** is **0, 1, 2, 3, 4, 5, 6**, accordingly.

3.15 Conditional Expressions

A conditional expression evaluates an expression based on a condition.



You might want to assign a value to a variable that is restricted by certain conditions. For example, the following statement assigns **1** to **y** if **x** is greater than **0**, and **-1** to **y** if **x** is less than or equal to **0**.

```
if (x > 0)
    y = 1;
else
    y = -1;
```

Alternatively, as in the following example, you can use a conditional expression to achieve the same result.

```
y = (x > 0) ? 1 : -1;
```

Conditional expressions are in a completely different style, with no explicit **if** in the statement. The syntax is:

conditional expression

```
boolean-expression ? expression1 : expression2;
```

The result of this conditional expression is **expression1** if **boolean-expression** is true; otherwise the result is **expression2**.

Suppose you want to assign the larger number of variable **num1** and **num2** to **max**. You can simply write a statement using the conditional expression:

```
max = (num1 > num2) ? num1 : num2;
```

For another example, the following statement displays the message “num is even” if **num** is even, and otherwise displays “num is odd.”

```
System.out.println((num % 2 == 0) ? "num is even" : "num is odd");
```

As you can see from these examples, conditional expressions enable you to write short and concise code.



Note

The symbols **?** and **:** appear together in a conditional expression. They form a conditional operator called a *ternary operator* because it uses three operands. It is the only ternary operator in Java.



MyProgrammingLab™

3.33 Suppose that, when you run the following program, you enter input **2 3 6** from the console. What is the output?

```
public class Test {
    public static void main(String[] args) {
        java.util.Scanner input = new java.util.Scanner(System.in);
        double x = input.nextDouble();
        double y = input.nextDouble();
        double z = input.nextDouble();

        System.out.println((x < y && y < z) ? "sorted" : "not sorted");
    }
}
```

3.34 Rewrite the following **if** statements using the conditional operator.

```
if (ages >= 16)
    ticketPrice = 20;
else
    ticketPrice = 10;
```

```
if (count % 10 == 0)
    System.out.print(count + "\n");
else
    System.out.print(count);
```

3.35 Rewrite the following conditional expressions using **if-else** statements.

- score = (x > 10) ? 3 * scale : 4 * scale;
- tax = (income > 10000) ? income * 0.2 : income * 0.17 + 1000;
- System.out.println((number % 3 == 0) ? i : j);

3.16 Formatting Console Output



You can use the **System.out.printf** method to display formatted output on the console.

Often it is desirable to display numbers in a certain format. For example, the following code computes interest, given the amount and the annual interest rate.

```
double amount = 12618.98;
double interestRate = 0.0013;
```

```
double interest = amount * interestRate;
System.out.println("Interest is " + interest);
```



```
Interest is 16.404674
```

Because the interest amount is currency, it is desirable to display only two digits after the decimal point. To do this, you can write the code as follows:

```
double amount = 12618.98;
double interestRate = 0.0013;
double interest = amount * interestRate;
System.out.println("Interest is "
    + (int)(interest * 100) / 100.0);
```

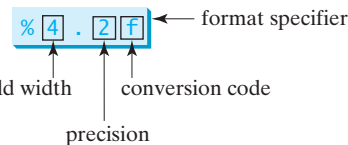


```
Interest is 16.4
```

However, the format is still not correct. There should be two digits after the decimal point: **16.40** rather than **16.4**. You can fix it by using the `printf` method, like this:

`printf`

```
double amount = 12618.98;
double interestRate = 0.0013;
double interest = amount * interestRate;
System.out.printf("Interest is %4.2f", interest);
```



```
Interest is 16.40
```



The syntax to invoke this method is

```
System.out.printf(format, item1, item2, ..., itemk)
```

where **format** is a string that may consist of substrings and format specifiers.

A *format specifier* specifies how an item should be displayed. An item may be a numeric value, a character, a Boolean value, or a string. A simple format specifier consists of a percent sign (%) followed by a conversion code. Table 3.8 lists some frequently used simple format specifiers.

`format specifier`

TABLE 3.8 Frequently Used Format Specifiers

Format Specifier	Output	Example
<code>%b</code>	a Boolean value	true or false
<code>%c</code>	a character	'a'
<code>%d</code>	a decimal integer	200
<code>%f</code>	a floating-point number	45.460000
<code>%e</code>	a number in standard scientific notation	4.556000e+01
<code>%s</code>	a string	"Java is cool"

Here is an example:

```
int count = 5;
double amount = 45.56;
System.out.printf("count is %d and amount is %f", count, amount);
```

display count is 5 and amount is 45.560000

Items must match the format specifiers in order, in number, and in exact type. For example, the format specifier for **count** is **%d** and for **amount** is **%f**. By default, a floating-point value is displayed with six digits after the decimal point. You can specify the width and precision in a format specifier, as shown in the examples in Table 3.9.

TABLE 3.9 Examples of Specifying Width and Precision

Example	Output
%5c	Output the character and add four spaces before the character item, because the width is 5.
%6b	Output the Boolean value and add one space before the false value and two spaces before the true value.
%5d	Output the integer item with width at least 5. If the number of digits in the item is <5, add spaces before the number. If the number of digits in the item is >5, the width is automatically increased.
%10.2f	Output the floating-point item with width at least 10 including a decimal point and two digits after the point. Thus there are 7 digits allocated before the decimal point. If the number of digits before the decimal point in the item is <7, add spaces before the number. If the number of digits before the decimal point in the item is >7, the width is automatically increased.
%10.2e	Output the floating-point item with width at least 10 including a decimal point, two digits after the point and the exponent part. If the displayed number in scientific notation has width less than 10, add spaces before the number.
%12s	Output the string with width at least 12 characters. If the string item has fewer than 12 characters, add spaces before the string. If the string item has more than 12 characters, the width is automatically increased.

If an item requires more spaces than the specified width, the width is automatically increased. For example, the following code

```
System.out.printf("%3d#%2s#%3.2f\n", 1234, "Java", 51.6653);
```

displays

```
1234#Java#51.67
```

The specified width for **int** item **1234** is **3**, which is smaller than its actual size **4**. The width is automatically increased to **4**. The specified width for string item **Java** is **2**, which is smaller than its actual size **4**. The width is automatically increased to **4**. The specified width for **double** item **51.6653** is **3**, but it needs width 5 to display 51.67, so the width is automatically increased to **5**.

By default, the output is right justified. You can put the minus sign (-) in the format specifier to specify that the item is left justified in the output within the specified field. For example, the following statements

```
System.out.printf("%8d%8s%8.1f\n", 1234, "Java", 5.63);
System.out.printf("%-8d%-8s%-8.1f \n", 1234, "Java", 5.63);
```

display

```

|← 8 →|← 8 →|← 8 →|
□□□□ 1234 □□□□ Java □□□□ 5.6
1234 □□□□ Java □□□□ 5.6 □□□□
```

where the square box (□) denotes a blank space.



Caution

The items must match the format specifiers in exact type. The item for the format specifier `%f` or `%e` must be a floating-point type value such as `40.0`, not `40`. Thus, an `int` variable cannot match `%f` or `%e`.



Tip

The `%` sign denotes a format specifier. To output a literal `%` in the format string, use `%%`.

- 3.36** What are the format specifiers for outputting a Boolean value, a character, a decimal integer, a floating-point number, and a string?
- 3.37** What is wrong in the following statements?
- `System.out.printf("%5d %d", 1, 2, 3);`
 - `System.out.printf("%5d %f", 1);`
 - `System.out.printf("%5d %f", 1, 2);`
- 3.38** Show the output of the following statements.
- `System.out.printf("amount is %f %e\n", 32.32, 32.32);`
 - `System.out.printf("amount is %5.4f %5.4e\n", 32.32, 32.32);`
 - `System.out.printf("%6b\n", (1 > 2));`
 - `System.out.printf("%6s\n", "Java");`
 - `System.out.printf("%-6b%s\n", (1 > 2), "Java");`
 - `System.out.printf("%6b%-8s\n", (1 > 2), "Java");`



Check
Point

MyProgrammingLab™

3.17 Operator Precedence and Associativity

Operator precedence and associativity determine the order in which operators are evaluated.



Key
Point

Section 2.11 introduced operator precedence involving arithmetic operators. This section discusses operator precedence in more details. Suppose that you have this expression:

```
3 + 4 * 4 > 5 * (4 + 3) - 1 && (4 - 3 > 5)
```

What is its value? What is the execution order of the operators?


The expression in the parentheses is evaluated first. (Parentheses can be nested, in which case the expression in the inner parentheses is executed first.) When evaluating an expression without

parentheses, the operators are applied according to the precedence rule and the associativity rule.

The precedence rule defines precedence for operators, as shown in Table 3.10, which contains the operators you have learned so far. Operators are listed in decreasing order of precedence from top to bottom. The logical operators have lower precedence than the relational operators and the relational operators have lower precedence than the arithmetic operators. Operators with the same precedence appear in the same group. (See Appendix C, *Operator Precedence Chart*, for a complete list of Java operators and their precedence.)

operator precedence

TABLE 3.10 Operator Precedence Chart

Precedence	Operator
	var++ and var-- (Postfix)
	+ , - (Unary plus and minus), ++var and --var (Prefix)
	(type) (Casting)
	! (Not)
	* , / , % (Multiplication, division, and remainder)
	+ , - (Binary addition and subtraction)
	< , <= , > , >= (Comparison)
	== , != (Equality)
	^ (Exclusive OR)
	&& (AND)
	 (OR)
	= , += , -= , *= , /= , %= (Assignment operator)

operator associativity

If operators with the same precedence are next to each other, their *associativity* determines the order of evaluation. All binary operators except assignment operators are *left associative*. For example, since **+** and **-** are of the same precedence and are left associative, the expression

$$a - b + c - d \quad \underline{\underline{\text{is equivalent to}}} \quad ((a - b) + c) - d$$

Assignment operators are *right associative*. Therefore, the expression

$$a = b += c = 5 \quad \underline{\underline{\text{is equivalent to}}} \quad a = (b += (c = 5))$$

Suppose **a**, **b**, and **c** are **1** before the assignment; after the whole expression is evaluated, **a** becomes **6**, **b** becomes **6**, and **c** becomes **5**. Note that left associativity for the assignment operator would not make sense.



Note

Java has its own way to evaluate an expression internally. The result of a Java evaluation is the same as that of its corresponding arithmetic evaluation. Advanced readers may refer to Supplement III.B for more discussions on how an expression is evaluated in Java *behind the scenes*.

behind the scenes

3.39 List the precedence order of the Boolean operators. Evaluate the following expressions:

```
true || true && false
true && true || false
```



MyProgrammingLab™

3.40 True or false? All the binary operators except = are left associative.

3.41 Evaluate the following expressions:

```
2 * 2 - 3 > 2 && 4 - 2 > 5
2 * 2 - 3 > 2 || 4 - 2 > 5
```

3.42 Is $(x > 0 \ \&\& \ x < 10)$ the same as $((x > 0) \ \&\& \ (x < 10))$? Is $(x > 0 \ || \ x < 10)$ the same as $((x > 0) \ || \ (x < 10))$? Is $(x > 0 \ || \ x < 10 \ \&\& \ y < 0)$ the same as $(x > 0 \ || \ (x < 10 \ \&\& \ y < 0))$?

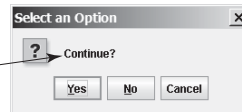
3.18 Confirmation Dialogs

You can use a confirmation dialog to obtain a confirmation from the user.



You have used `showMessageDialog` to display a message dialog box and `showInputDialog` to display an input dialog box. Occasionally it is useful to answer a question with a confirmation dialog box. A confirmation dialog can be created using the following statement:

```
int option =
    JOptionPane.showConfirmDialog
        (null, "Continue");
```



When a button is clicked, the method returns an option value. The value is `JOptionPane.YES_OPTION` (0) for the *Yes* button, `JOptionPane.NO_OPTION` (1) for the *No* button, and `JOptionPane.CANCEL_OPTION` (2) for the *Cancel* button.

You may rewrite the guess-birthday program in Listing 3.3 using confirmation dialog boxes, as shown in Listing 3.11. Figure 3.8 shows a sample run of the program for the day 19.

LISTING 3.11 GuessBirthdayUsingConfirmationDialog.java

```
1 import javax.swing.JOptionPane; import class
2
3 public class GuessBirthdayUsingConfirmationDialog {
4     public static void main(String[] args) {
5         String set1 = set1
6             " 1 3 5 7\n" +
7             " 9 11 13 15\n" +
8             "17 19 21 23\n" +
9             "25 27 29 31";
10
11         String set2 = set2
12             " 2 3 6 7\n" +
13             "10 11 14 15\n" +
14             "18 19 22 23\n" +
15             "26 27 30 31";
16
```

```

set3          17      String set3 =
              18      " 4 5 6 7\n" +
              19      "12 13 14 15\n" +
              20      "20 21 22 23\n" +
              21      "28 29 30 31";
              22
set4          23      String set4 =
              24      " 8 9 10 11\n" +
              25      "12 13 14 15\n" +
              26      "24 25 26 27\n" +
              27      "28 29 30 31";
              28
set5          29      String set5 =
              30      "16 17 18 19\n" +
              31      "20 21 22 23\n" +
              32      "24 25 26 27\n" +
              33      "28 29 30 31";
              34
              35      int day = 0;
              36
confirmation dialog 37      // Prompt the user to answer questions
              38      int answer = JOptionPane.showConfirmDialog(null,
              39      "Is your birthday in these numbers?\n" + set1);
              40
in set1?      41      if (answer == JOptionPane.YES_OPTION)
              42          day += 1;
              43
              44      answer = JOptionPane.showConfirmDialog(null,
              45      "Is your birthday in these numbers?\n" + set2);
              46
in set2?      47      if (answer == JOptionPane.YES_OPTION)
              48          day += 2;
              49
              50      answer = JOptionPane.showConfirmDialog(null,
              51      "Is your birthday in these numbers?\n" + set3);
              52
in set3?      53      if (answer == JOptionPane.YES_OPTION)
              54          day += 4;
              55
              56      answer = JOptionPane.showConfirmDialog(null,
              57      "Is your birthday in these numbers?\n" + set4);
              58
in set4?      59      if (answer == JOptionPane.YES_OPTION)
              60          day += 8;
              61
              62      answer = JOptionPane.showConfirmDialog(null,
              63      "Is your birthday in these numbers?\n" + set5);
              64
in set5?      65      if (answer == JOptionPane.YES_OPTION)
              66          day += 16;
              67
              68      JOptionPane.showMessageDialog(null, "Your birthday is " +
              69      day + "!");
              70  }
              71  }

```

The program displays confirmation dialog boxes to prompt the user to answer whether a number is in Set1 (line 38), Set2 (line 44), Set3 (line 50), Set4 (line 56), and Set5 (line 62). If the answer is Yes, the first number in the set is added to `day` (lines 42, 48, 54, 60, and 66).

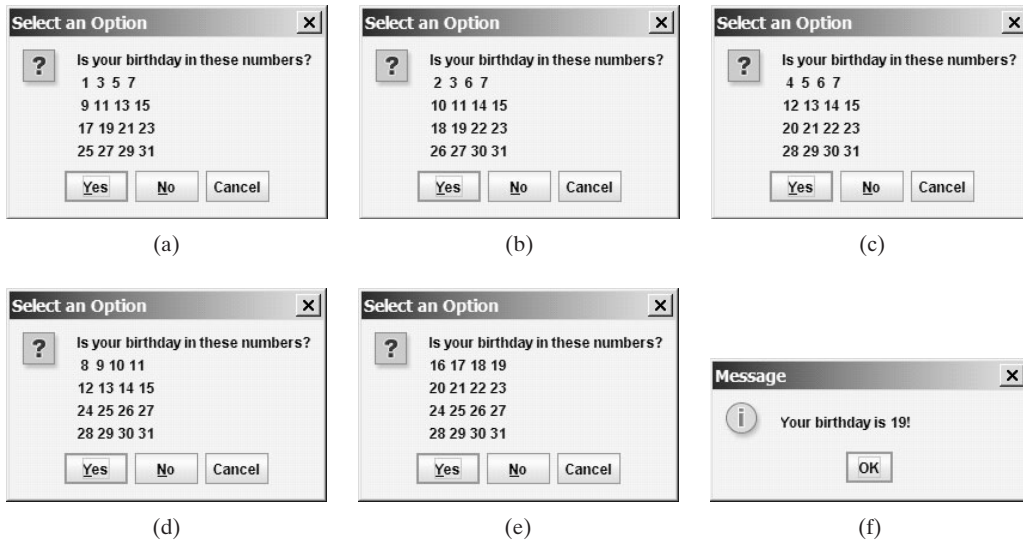


FIGURE 3.8 Click Yes in (a), Yes in (b), No in (c), No in (d), and Yes in (e).

3.43 How do you display a confirmation dialog? What value is returned when invoking `JOptionPane.showConfirmDialog`?



3.19 Debugging

Debugging is the process of finding and fixing errors in a program.

As mentioned in Section 1.11.1, syntax errors are easy to find and easy to correct because the compiler gives indications as to where the errors came from and why they are there. Runtime errors are not difficult to find either, because the Java interpreter displays them on the console when the program aborts. Finding logic errors, on the other hand, can be very challenging.

Logic errors are called *bugs*. The process of finding and correcting errors is called *debugging*. A common approach to debugging is to use a combination of methods to help pinpoint the part of the program where the bug is located. You can *hand-trace* the program (i.e., catch errors by reading the program), or you can insert print statements in order to show the values of the variables or the execution flow of the program. These approaches might work for debugging a short, simple program, but for a large, complex program, the most effective approach is to use a debugger utility.

JDK includes a command-line debugger, `jdb`, which is invoked with a class name. `jdb` is itself a Java program, running its own copy of Java interpreter. All the Java IDE tools, such as Eclipse and NetBeans, include integrated debuggers. The debugger utilities let you follow the execution of a program. They vary from one system to another, but they all support most of the following helpful features.

- **Executing a single statement at a time:** The debugger allows you to execute one statement at a time so that you can see the effect of each statement.
- **Tracing into or stepping over a method:** If a method is being executed, you can ask the debugger to enter the method and execute one statement at a time in the method, or you can ask it to step over the entire method. You should step over the entire method if you know that the method works. For example, always step over system-supplied methods, such as `System.out.println`.



bugs
debugging
hand-traces

- **Setting breakpoints:** You can also set a breakpoint at a specific statement. Your program pauses when it reaches a breakpoint. You can set as many breakpoints as you want. Breakpoints are particularly useful when you know where your program error starts. You can set a breakpoint at that statement and have the program execute until it reaches the breakpoint.
- **Displaying variables:** The debugger lets you select several variables and display their values. As you trace through a program, the content of a variable is continuously updated.
- **Displaying call stacks:** The debugger lets you trace all of the method calls. This feature is helpful when you need to see a large picture of the program-execution flow.
- **Modifying variables:** Some debuggers enable you to modify the value of a variable when debugging. This is convenient when you want to test a program with different samples but do not want to leave the debugger.

debugging in IDE

**Tip**

If you use an IDE such as Eclipse or NetBeans, please refer to *Learning Java Effectively with Eclipse/NetBeans* in Supplements II.C and II.E on the Companion Website. The supplement shows you how to use a debugger to trace programs and how debugging can help in learning Java effectively.

KEY TERMS

Boolean expression	82	flowchart	84
boolean data type	82	format specifier	113
Boolean value	82	operator associativity	116
conditional operator	104	operator precedence	116
dangling else ambiguity	94	selection statement	82
debugging	119	short-circuit operator	104
fall-through behavior	109		

CHAPTER SUMMARY

1. A **boolean** type variable can store a **true** or **false** value.
2. The relational operators (**<**, **<=**, **==**, **!=**, **>**, **>=**) work with numbers and characters, and yield a Boolean value.
3. The Boolean operators **&&**, **||**, **!**, and **^** operate with Boolean values and variables.
4. When evaluating **p1 && p2**, Java first evaluates **p1** and then evaluates **p2** if **p1** is **true**; if **p1** is **false**, it does not evaluate **p2**. When evaluating **p1 || p2**, Java first evaluates **p1** and then evaluates **p2** if **p1** is **false**; if **p1** is **true**, it does not evaluate **p2**. Therefore, **&&** is referred to as the *conditional* or *short-circuit AND operator*, and **||** is referred to as the *conditional* or *short-circuit OR operator*.
5. *Selection statements* are used for programming with alternative courses of actions. There are several types of selection statements: **if** statements, two-way **if-else** statements, nested **if** statements, multi-way **if-else** statements, **switch** statements, and conditional expressions.

6. The various **if** statements all make control decisions based on a *Boolean expression*. Based on the **true** or **false** evaluation of the expression, these statements take one of two possible courses.
7. The **switch** statement makes control decisions based on a switch expression of type **char**, **byte**, **short**, **int**, or **String**.
8. The keyword **break** is optional in a **switch** statement, but it is normally used at the end of each case in order to skip the remainder of the **switch** statement. If the **break** statement is not present, the next **case** statement will be executed.
9. The operators in expressions are evaluated in the order determined by the rules of parentheses, *operator precedence*, and *operator associativity*.
10. Parentheses can be used to force the order of evaluation to occur in any sequence.
11. Operators with higher precedence are evaluated earlier. For operators of the same precedence, their associativity determines the order of evaluation.
12. All binary operators except assignment operators are left-associative; assignment operators are right-associative.

TEST QUESTIONS

Do the test questions for this chapter online at www.cs.armstrong.edu/liang/intro9e/test.html.

PROGRAMMING EXERCISES

MyProgrammingLab™



Pedagogical Note

For each exercise, carefully analyze the problem requirements and design strategies for solving the problem before coding.

think before coding



Debugging Tip

Before you ask for help, read and explain the program to yourself, and trace it using several representative inputs by hand or using an IDE debugger. You learn how to program by debugging your own mistakes.

learn from mistakes

Section 3.2

- *3.1** (*Algebra: solve quadratic equations*) The two roots of a quadratic equation $ax^2 + bx + c = 0$ can be obtained using the following formula:

$$r_1 = \frac{-b + \sqrt{b^2 - 4ac}}{2a} \quad \text{and} \quad r_2 = \frac{-b - \sqrt{b^2 - 4ac}}{2a}$$

$b^2 - 4ac$ is called the discriminant of the quadratic equation. If it is positive, the equation has two real roots. If it is zero, the equation has one root. If it is negative, the equation has no real roots.

Write a program that prompts the user to enter values for a , b , and c and displays the result based on the discriminant. If the discriminant is positive, display two roots. If the discriminant is **0**, display one root. Otherwise, display “The equation has no real roots”.

Note that you can use `Math.pow(x, 0.5)` to compute \sqrt{x} . Here are some sample runs.



Enter a, b, c: 1.0 3 1
The roots are -0.381966 and -2.61803



Enter a, b, c: 1 2.0 1
The root is -1



Enter a, b, c: 1 2 3
The equation has no real roots

3.2 (*Game: add three numbers*) The program in Listing 3.1 generates two integers and prompts the user to enter the sum of these two integers. Revise the program to generate three single-digit integers and prompt the user to enter the sum of these three integers.

Sections 3.3–3.8

***3.3** (*Algebra: solve 2×2 linear equations*) You can use Cramer's rule to solve the following 2×2 system of linear equation:

$$\begin{array}{l} ax + by = e \\ cx + dy = f \end{array} \quad x = \frac{ed - bf}{ad - bc} \quad y = \frac{af - ec}{ad - bc}$$

Write a program that prompts the user to enter a , b , c , d , e , and f and displays the result. If $ad - bc$ is 0, report that “The equation has no solution”.



Enter a, b, c, d, e, f: 9.0 4.0 3.0 -5.0 -6.0 -21.0
x is -2.0 and y is 3.0



Enter a, b, c, d, e, f: 1.0 2.0 2.0 4.0 4.0 5.0
The equation has no solution

****3.4** (*Game: learn addition*) Write a program that generates two integers under 100 and prompts the user to enter the sum of these two integers. The program then reports true if the answer is correct, false otherwise. The program is similar to Listing 3.1.

***3.5** (*Find future dates*) Write a program that prompts the user to enter an integer for today's day of the week (Sunday is 0, Monday is 1, . . . , and Saturday is 6). Also prompt the user to enter the number of days after today for a future day and display the future day of the week. Here is a sample run:



Enter today's day: 1
Enter the number of days elapsed since today: 3
Today is Monday and the future day is Thursday

```

Enter today's day: 0 [Enter]
Enter the number of days elapsed since today: 31 [Enter]
Today is Sunday and the future day is Wednesday
    
```



- *3.6** (*Health application: BMI*) Revise Listing 3.5, `ComputeAndInterpretBMI.java`, to let the user enter weight, feet, and inches. For example, if a person is 5 feet and 10 inches, you will enter 5 for feet and 10 for inches. Here is a sample run:

```

Enter weight in pounds: 140 [Enter]
Enter feet: 5 [Enter]
Enter inches: 10 [Enter]
BMI is 20.087702275404553
Normal
    
```



- 3.7** (*Financial application: monetary units*) Modify Listing 2.10, `ComputeChange.java`, to display the nonzero denominations only, using singular words for single units such as 1 dollar and 1 penny, and plural words for more than one unit such as 2 dollars and 3 pennies.



VideoNote

Sort three integers

- *3.8** (*Sort three integers*) Write a program that sorts three integers. The integers are entered from the input dialogs and stored in variables `num1`, `num2`, and `num3`, respectively. The program sorts the numbers so that $num1 \leq num2 \leq num3$.

- **3.9** (*Business: check ISBN-10*) An **ISBN-10** (International Standard Book Number) consists of 10 digits: $d_1d_2d_3d_4d_5d_6d_7d_8d_9d_{10}$. The last digit, d_{10} , is a checksum, which is calculated from the other nine digits using the following formula:

$$(d_1 \times 1 + d_2 \times 2 + d_3 \times 3 + d_4 \times 4 + d_5 \times 5 + d_6 \times 6 + d_7 \times 7 + d_8 \times 8 + d_9 \times 9) \% 11$$

If the checksum is 10, the last digit is denoted as X according to the ISBN-10 convention. Write a program that prompts the user to enter the first 9 digits and displays the 10-digit ISBN (including leading zeros). Your program should read the input as an integer. Here are sample runs:

```

Enter the first 9 digits of an ISBN as integer: 013601267 [Enter]
The ISBN-10 number is 0136012671
    
```



```

Enter the first 9 digits of an ISBN as integer: 013031997 [Enter]
The ISBN-10 number is 013031997X
    
```



- 3.10** (*Game: addition quiz*) Listing 3.4, `SubtractionQuiz.java`, randomly generates a subtraction question. Revise the program to randomly generate an addition question with two integers less than 100.

Sections 3.9–3.19

- *3.11** (*Find the number of days in a month*) Write a program that prompts the user to enter the month and year and displays the number of days in the month. For

example, if the user entered month **2** and year **2012**, the program should display that February 2012 had 29 days. If the user entered month **3** and year **2015**, the program should display that March 2015 had 31 days.

3.12 (*Check a number*) Write a program that prompts the user to enter an integer and checks whether the number is divisible by both 5 and 6, or neither of them, or just one of them. Here are some sample runs for inputs **10**, **30**, and **23**.

```
10 is divisible by 5 or 6, but not both
30 is divisible by both 5 and 6
23 is not divisible by either 5 or 6
```

***3.13** (*Financial application: compute taxes*) Listing 3.6, `ComputeTax.java`, gives the source code to compute taxes for single filers. Complete Listing 3.6 to give the complete source code.

3.14 (*Game: heads or tails*) Write a program that lets the user guess whether the flip of a coin results in heads or tails. The program randomly generates an integer **0** or **1**, which represents head or tail. The program prompts the user to enter a guess and reports whether the guess is correct or incorrect.

****3.15** (*Game: lottery*) Revise Listing 3.9, `Lottery.java`, to generate a lottery of a three-digit number. The program prompts the user to enter a three-digit number and determines whether the user wins according to the following rules:

1. If the user input matches the lottery number in the exact order, the award is \$10,000.
2. If all the digits in the user input match all the digits in the lottery number, the award is \$3,000.
3. If one digit in the user input matches a digit in the lottery number, the award is \$1,000.

3.16 (*Random character*) Write a program that displays a random uppercase letter using the `Math.random()` method.

***3.17** (*Game: scissor, rock, paper*) Write a program that plays the popular scissor-rock-paper game. (A scissor can cut a paper, a rock can knock a scissor, and a paper can wrap a rock.) The program randomly generates a number **0**, **1**, or **2** representing scissor, rock, and paper. The program prompts the user to enter a number **0**, **1**, or **2** and displays a message indicating whether the user or the computer wins, loses, or draws. Here are sample runs:



```
scissor (0), rock (1), paper (2): 1 
The computer is scissor. You are rock. You won
```



```
scissor (0), rock (1), paper (2): 2 
The computer is paper. You are paper too. It is a draw
```

***3.18** (*Use the input dialog box*) Rewrite Listing 3.8, `LeapYear.java`, using the input dialog box.

****3.19** (*Compute the perimeter of a triangle*) Write a program that reads three edges for a triangle and computes the perimeter if the input is valid. Otherwise, display that the input is invalid. The input is valid if the sum of every pair of two edges is greater than the remaining edge.

- *3.20** (*Science: wind-chill temperature*) Programming Exercise 2.17 gives a formula to compute the wind-chill temperature. The formula is valid for temperatures in the range between -58°F and 41°F and wind speed greater than or equal to 2. Write a program that prompts the user to enter a temperature and a wind speed. The program displays the wind-chill temperature if the input is valid; otherwise, it displays a message indicating whether the temperature and/or wind speed is invalid.

Comprehensive

- **3.21** (*Science: day of the week*) Zeller's congruence is an algorithm developed by Christian Zeller to calculate the day of the week. The formula is

$$h = \left(q + \frac{26(m+1)}{10} + k + \frac{k}{4} + \frac{j}{4} + 5j \right) \% 7$$

where

- **h** is the day of the week (0: Saturday, 1: Sunday, 2: Monday, 3: Tuesday, 4: Wednesday, 5: Thursday, 6: Friday).
- **q** is the day of the month.
- **m** is the month (3: March, 4: April, . . . , 12: December). January and February are counted as months 13 and 14 of the previous year.
- **j** is the century (i.e., $\frac{\text{year}}{100}$).
- **k** is the year of the century (i.e., $\text{year} \% 100$).

Note that the division in the formula performs an integer division. Write a program that prompts the user to enter a year, month, and day of the month, and displays the name of the day of the week. Here are some sample runs:

```
Enter year: (e.g., 2012): 2015 ↵Enter
Enter month: 1-12: 1 ↵Enter
Enter the day of the month: 1-31: 25 ↵Enter
Day of the week is Sunday
```



```
Enter year: (e.g., 2012): 2012 ↵Enter
Enter month: 1-12: 5 ↵Enter
Enter the day of the month: 1-31: 12 ↵Enter
Day of the week is Saturday
```



(*Hint:* January and February are counted as 13 and 14 in the formula, so you need to convert the user input 1 to 13 and 2 to 14 for the month and change the year to the previous year.)

- **3.22** (*Geometry: point in a circle?*) Write a program that prompts the user to enter a point (x, y) and checks whether the point is within the circle centered at $(0, 0)$ with radius 10. For example, $(4, 5)$ is inside the circle and $(9, 9)$ is outside the circle, as shown in Figure 3.9a.



VideoNote
Check point location

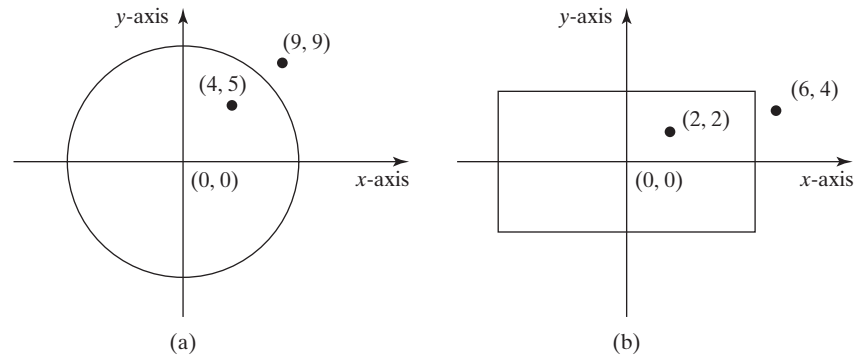


FIGURE 3.9 (a) Points inside and outside of the circle. (b) Points inside and outside of the rectangle.

(Hint: A point is in the circle if its distance to $(0, 0)$ is less than or equal to 10 . The formula for computing the distance is $\sqrt{(x_2 - x_1)^2 + (y_2 - y_1)^2}$. Test your program to cover all cases.) Two sample runs are shown below.



Enter a point with two coordinates: 4 5
Point (4.0, 5.0) is in the circle



Enter a point with two coordinates: 9 9
Point (9.0, 9.0) is not in the circle

****3.23** (Geometry: point in a rectangle?) Write a program that prompts the user to enter a point (x, y) and checks whether the point is within the rectangle centered at $(0, 0)$ with width 10 and height 5 . For example, $(2, 2)$ is inside the rectangle and $(6, 4)$ is outside the rectangle, as shown in Figure 3.9b. (Hint: A point is in the rectangle if its horizontal distance to $(0, 0)$ is less than or equal to $10 / 2$ and its vertical distance to $(0, 0)$ is less than or equal to $5.0 / 2$. Test your program to cover all cases.) Here are two sample runs.



Enter a point with two coordinates: 2 2
Point (2.0, 2.0) is in the rectangle



Enter a point with two coordinates: 6 4
Point (6.0, 4.0) is not in the rectangle

****3.24** (Game: pick a card) Write a program that simulates picking a card from a deck of 52 cards. Your program should display the rank (Ace, 2, 3, 4, 5, 6, 7, 8, 9, 10, Jack, Queen, King) and suit (Clubs, Diamonds, Hearts, Spades) of the card. Here is a sample run of the program:



The card you picked is Jack of Hearts

***3.25** (Geometry: intersecting point) Two points on line 1 are given as (x_1, y_1) and (x_2, y_2) and on line 2 as (x_3, y_3) and (x_4, y_4) , as shown in Figure 3.10a–b.

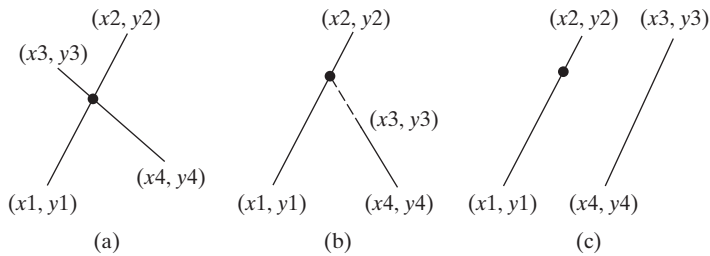


FIGURE 3.10 Two lines intersect in (a and b) and two lines are parallel in (c).

The intersecting point of the two lines can be found by solving the following linear equation:

$$(y_1 - y_2)x - (x_1 - x_2)y = (y_1 - y_2)x_1 - (x_1 - x_2)y_1$$

$$(y_3 - y_4)x - (x_3 - x_4)y = (y_3 - y_4)x_3 - (x_3 - x_4)y_3$$

This linear equation can be solved using Cramer's rule (see Exercise 3.3). If the equation has no solutions, the two lines are parallel (Figure 3.10c). Write a program that prompts the user to enter four points and displays the intersecting point. Here are sample runs:

```
Enter x1, y1, x2, y2, x3, y3, x4, y4: 2 2 5 -1.0 4.0 2.0 -1.0 -2.0 ↵ Enter
The intersecting point is at (2.88889, 1.1111)
```



```
Enter x1, y1, x2, y2, x3, y3, x4, y4: 2 2 7 6.0 4.0 2.0 -1.0 -2.0 ↵ Enter
The two lines are parallel
```

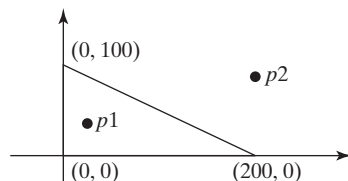


3.26 (Use the `&&`, `||` and `^` operators) Write a program that prompts the user to enter an integer and determines whether it is divisible by 5 and 6, whether it is divisible by 5 or 6, and whether it is divisible by 5 or 6, but not both. Here is a sample run of this program:

```
Enter an integer: 10 ↵ Enter
Is 10 divisible by 5 and 6? false
Is 10 divisible by 5 or 6? true
Is 10 divisible by 5 or 6, but not both? true
```



****3.27** (Geometry: points in triangle?) Suppose a right triangle is placed in a plane as shown below. The right-angle point is placed at $(0, 0)$, and the other two points are placed at $(200, 0)$, and $(0, 100)$. Write a program that prompts the user to enter a point with x - and y -coordinates and determines whether the point is inside the triangle. Here are the sample runs:





```
Enter a point's x- and y-coordinates: 100.5 25.5 ↵ Enter
The point is in the triangle
```



```
Enter a point's x- and y-coordinates: 100.5 50.5 ↵ Enter
The point is not in the triangle
```

****3.28** (*Geometry: two rectangles*) Write a program that prompts the user to enter the center x-, y-coordinates, width, and height of two rectangles and determines whether the second rectangle is inside the first or overlaps with the first, as shown in Figure 3.11. Test your program to cover all cases.

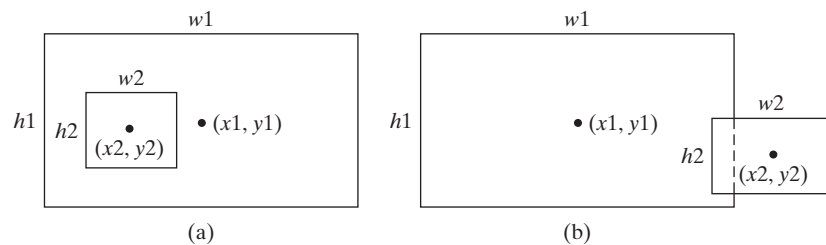


FIGURE 3.11 (a) A rectangle is inside another one. (b) A rectangle overlaps another one.

Here are the sample runs:



```
Enter r1's center x-, y-coordinates, width, and height: 2.5 4 2.5 43 ↵ Enter
Enter r2's center x-, y-coordinates, width, and height: 1.5 5 0.5 3 ↵ Enter
r2 is inside r1
```



```
Enter r1's center x-, y-coordinates, width, and height: 1 2 3 5.5 ↵ Enter
Enter r2's center x-, y-coordinates, width, and height: 3 4 4.5 5 ↵ Enter
r2 overlaps r1
```



```
Enter r1's center x-, y-coordinates, width, and height: 1 2 3 3 ↵ Enter
Enter r2's center x-, y-coordinates, width, and height: 40 45 3 2 ↵ Enter
r2 does not overlap r1
```

****3.29** (*Geometry: two circles*) Write a program that prompts the user to enter the center coordinates and radii of two circles and determines whether the second circle is inside the first or overlaps with the first, as shown in Figure 3.12. (*Hint*: circle2 is inside circle1 if the distance between the two centers $\leq |r_1 - r_2|$ and circle2 overlaps circle1 if the distance between the two centers $\leq r_1 + r_2$. Test your program to cover all cases.)

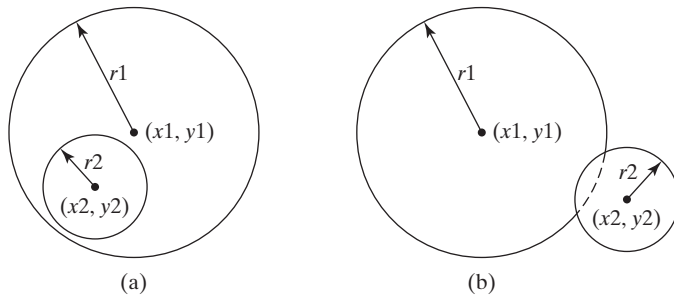


FIGURE 3.12 (a) A circle is inside another circle. (b) A circle overlaps another circle.

Here are the sample runs:

```
Enter circle1's center x-, y-coordinates, and radius: 0.5 5.1 13 ↵ Enter
Enter circle2's center x-, y-coordinates, and radius: 1 1.7 4.5 ↵ Enter
circle2 is inside circle1
```



```
Enter circle1's center x-, y-coordinates, and radius: 3.4 5.7 5.5 ↵ Enter
Enter circle2's center x-, y-coordinates, and radius: 6.7 3.5 3 ↵ Enter
circle2 overlaps circle1
```



```
Enter circle1's center x-, y-coordinates, and radius: 3.4 5.5 1 ↵ Enter
Enter circle2's center x-, y-coordinates, and radius: 5.5 7.2 1 ↵ Enter
circle2 does not overlap circle1
```



***3.30** (*Current time*) Revise Programming Exercise 2.8 to display the hour using a 12-hour clock. Here is a sample run:

```
Enter the time zone offset to GMT: -5 ↵ Enter
The current time is 4:50:34 AM
```



***3.31** (*Financials: currency exchange*) Write a program that prompts the user to enter the exchange rate from currency in U.S. dollars to Chinese RMB. Prompt the user to enter **0** to convert from U.S. dollars to Chinese RMB and **1** to convert from Chinese RMB and U.S. dollars. Prompt the user to enter the amount in U.S. dollars or Chinese RMB to convert it to Chinese RMB or U.S. dollars, respectively. Here are the sample runs:

```
Enter the exchange rate from dollars to RMB: 6.81 ↵ Enter
Enter 0 to convert dollars to RMB and 1 vice versa: 0 ↵ Enter
Enter the dollar amount: 100 ↵ Enter
$100.0 is 681.0 yuan
```





```
Enter the exchange rate from dollars to RMB: 6.81 ↵Enter
Enter 0 to convert dollars to RMB and 1 vice versa: 1 ↵Enter
Enter the RMB amount: 10000 ↵Enter
10000.0 yuan is $1468.43
```



```
Enter the exchange rate from dollars to RMB: 6.81 ↵Enter
Enter 0 to convert dollars to RMB and 1 vice versa: 5 ↵Enter
Incorrect input
```

***3.32** (*Geometry: point position*) Given a directed line from point $p_0(x_0, y_0)$ to $p_1(x_1, y_1)$, you can use the following condition to decide whether a point $p_2(x_2, y_2)$ is on the left of the line, on the right, or on the same line (see Figure 3.13):

$$(x_1 - x_0) * (y_2 - y_0) - (x_2 - x_0) * (y_1 - y_0) \begin{cases} > 0 & p_2 \text{ is on the left side of the line} \\ = 0 & p_2 \text{ is on the same line} \\ < 0 & p_2 \text{ is on the right side of the line} \end{cases}$$

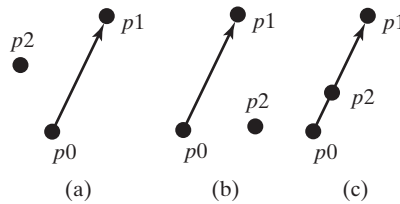


FIGURE 3.13 (a) p_2 is on the left of the line. (b) p_2 is on the right of the line. (c) p_2 is on the same line.

Write a program that prompts the user to enter the three points for p_0 , p_1 , and p_2 and displays whether p_2 is on the left of the line from p_0 to p_1 , to the right, or on the same line. Here are some sample runs:



```
Enter three points for p0, p1, and p2: 4.4 2 6.5 9.5 -5 4 ↵Enter
p2 is on the left side of the line
```



```
Enter three points for p0, p1, and p2: 1 1 5 5 2 2 ↵Enter
p2 is on the same line
```



```
Enter three points for p0, p1, and p2: 3.4 2 6.5 9.5 5 2.5 ↵Enter
p2 is on the right side of the line
```

***3.33** (*Financial: compare costs*) Suppose you shop for rice in two different packages. You would like to write a program to compare the cost. The program prompts the user to enter the weight and price of the each package and displays the one with the better price. Here is a sample run:

```
Enter weight and price for package 1: 50 24.59 ↵ Enter
Enter weight and price for package 2: 25 11.99 ↵ Enter
Package 1 has a better price.
```



- *3.34** (*Geometry: point on line segment*) Exercise 3.32 shows how to test whether a point is on an unbounded line. Revise Exercise 3.32 to test whether a point is on a line segment. Write a program that prompts the user to enter the three points for p_0 , p_1 , and p_2 and displays whether p_2 is on the line segment from p_0 to p_1 . Here are some sample runs:

```
Enter three points for p0, p1, and p2: 1 1 2.5 2.5 1.5 1.5 ↵ Enter
(1.5, 1.5) is on the line segment from (1.0, 1.0) to (2.5, 2.5)
```



```
Enter three points for p0, p1, and p2: 1 1 2 2 3.5 3.5 ↵ Enter
(3.5, 3.5) is not on the line segment from (1.0, 1.0) to (2.0, 2.0)
```



- *3.35** (*Decimal to hex*) Write a program that prompts the user to enter an integer between 0 and 15 and displays its corresponding hex number. Here are some sample runs:

```
Enter a decimal value (0 to 15): 11 ↵ Enter
The hex value is B
```



```
Enter a decimal value (0 to 15): 5 ↵ Enter
The hex value is 5
```



```
Enter a decimal value (0 to 15): 31 ↵ Enter
Invalid input
```



This page intentionally left blank

LOOPS

Objectives

- To write programs for executing statements repeatedly using a **while** loop (§4.2).
- To follow the loop design strategy to develop loops (§§4.2.1–4.2.3).
- To control a loop with a sentinel value (§4.2.4).
- To obtain large input from a file using input redirection rather than typing from the keyboard (§4.2.5).
- To write loops using **do-while** statements (§4.3).
- To write loops using **for** statements (§4.4).
- To discover the similarities and differences of three types of loop statements (§4.5).
- To write nested loops (§4.6).
- To learn the techniques for minimizing numerical errors (§4.7).
- To learn loops from a variety of examples (**GCD**, **FutureTuition**, **MonteCarloSimulation**) (§4.8).
- To implement program control with **break** and **continue** (§4.9).
- To write a program that displays prime numbers (§4.10).
- To control a loop with a confirmation dialog (§4.11).



4.1 Introduction



A loop can be used to tell a program to execute statements repeatedly.

problem

Suppose that you need to display a string (e.g., **Welcome to Java!**) a hundred times. It would be tedious to have to write the following statement a hundred times:

```
100 times {
    System.out.println("Welcome to Java!");
    System.out.println("Welcome to Java!");
    ...
    System.out.println("Welcome to Java!");
}
```

loop

So, how do you solve this problem?

Java provides a powerful construct called a *loop* that controls how many times an operation or a sequence of operations is performed in succession. Using a loop statement, you simply tell the computer to display a string a hundred times without having to code the print statement a hundred times, as follows:

```
int count = 0;
while (count < 100) {
    System.out.println("Welcome to Java!");
    count++;
}
```

The variable **count** is initially **0**. The loop checks whether **count < 100** is **true**. If so, it executes the loop body to display the message **Welcome to Java!** and increments **count** by **1**. It repeatedly executes the loop body until **count < 100** becomes **false**. When **count < 100** is **false** (i.e., when **count** reaches **100**), the loop terminates and the next statement after the loop statement is executed.

Loops are constructs that control repeated executions of a block of statements. The concept of looping is fundamental to programming. Java provides three types of loop statements: **while** loops, **do-while** loops, and **for** loops.

4.2 The while Loop



A while loop executes statements repeatedly while the condition is true.

The syntax for the **while** loop is:

while loop

```
while (loop-continuation-condition) {
    // Loop body
    Statement(s);
}
```

loop body

iteration

loop-continuation-
condition

Figure 4.1a shows the **while**-loop flowchart. The part of the loop that contains the statements to be repeated is called the *loop body*. A one-time execution of a loop body is referred to as an *iteration* (or *repetition*) of the loop. Each loop contains a *loop-continuation-condition*, a Boolean expression that controls the execution of the body. It is evaluated each time to determine if the loop body is executed. If its evaluation is **true**, the loop body is executed; if its evaluation is **false**, the entire loop terminates and the program control turns to the statement that follows the **while** loop.

The loop for displaying **Welcome to Java!** a hundred times introduced in the preceding section is an example of a **while** loop. Its flowchart is shown in Figure 4.1b. The

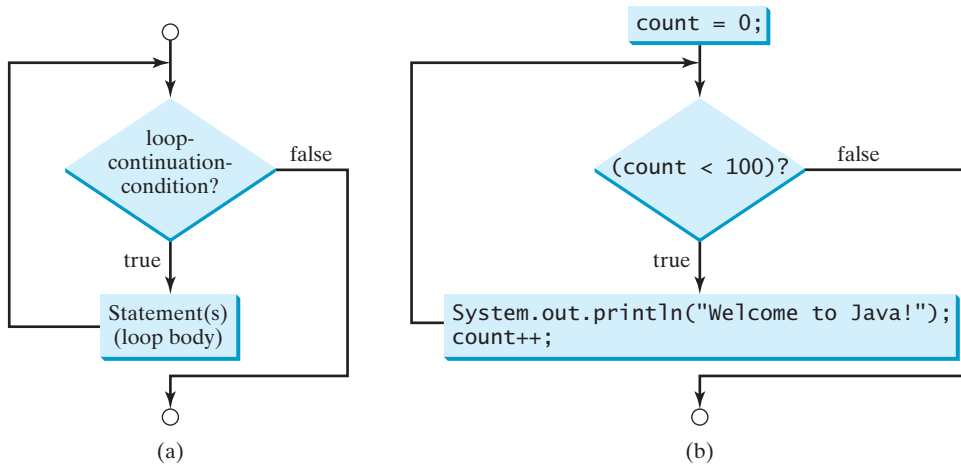


FIGURE 4.1 The `while` loop repeatedly executes the statements in the loop body when the **loop-continuation-condition** evaluates to **true**.

loop-continuation-condition is `count < 100` and the loop body contains the following two statements:

```

int count = 0;
while (count < 100) {
    System.out.println("Welcome to Java!");
    count++;
}

```

loop-continuation-condition

} loop body

In this example, you know exactly how many times the loop body needs to be executed because the control variable `count` is used to count the number of executions. This type of loop is known as a *counter-controlled loop*.

counter-controlled loop



Note

The **loop-continuation-condition** must always appear inside the parentheses. The braces enclosing the loop body can be omitted only if the loop body contains one or no statement.

Here is another example to help understand how a loop works.

```

int sum = 0, i = 1;
while (i < 10) {
    sum = sum + i;
    i++;
}
System.out.println("sum is " + sum); // sum is 45

```

If `i < 10` is **true**, the program adds `i` to `sum`. Variable `i` is initially set to `1`, then is incremented to `2`, `3`, and up to `10`. When `i` is `10`, `i < 10` is **false**, so the loop exits. Therefore, the sum is `1 + 2 + 3 + ... + 9 = 45`.

What happens if the loop is mistakenly written as follows?

```

int sum = 0, i = 1;
while (i < 10) {
    sum = sum + i;
}

```

This loop is infinite, because `i` is always `1` and `i < 10` will always be `true`.

infinite loop



Note

Make sure that the **loop-continuation-condition** eventually becomes **false** so that the loop will terminate. A common programming error involves *infinite loops* (i. e., the loop runs forever). If your program takes an unusually long time to run and does not stop, it may have an infinite loop. If you are running the program from the command window, press `CTRL+C` to stop it.

off-by-one error



Caution

Programmers often make the mistake of executing a loop one more or less time. This is commonly known as the *off-by-one error*. For example, the following loop displays **Welcome to Java** 101 times rather than 100 times. The error lies in the condition, which should be `count < 100` rather than `count <= 100`.

```
int count = 0;
while (count <= 100) {
    System.out.println("Welcome to Java!");
    count++;
}
```

Recall that Listing 3.1, `AdditionQuiz.java`, gives a program that prompts the user to enter an answer for a question on addition of two single digits. Using a loop, you can now rewrite the program to let the user repeatedly enter a new answer until it is correct, as shown in Listing 4.1.

LISTING 4.1 RepeatAdditionQuiz.java

generate number1
generate number2

show question

get first answer

check answer

read an answer

```
1 import java.util.Scanner;
2
3 public class RepeatAdditionQuiz {
4     public static void main(String[] args) {
5         int number1 = (int)(Math.random() % 10);
6         int number2 = (int)(Math.random() % 10);
7
8         // Create a Scanner
9         Scanner input = new Scanner(System.in);
10
11        System.out.print(
12            "What is " + number1 + " + " + number2 + "? ";
13        int answer = input.nextInt();
14
15        while (number1 + number2 != answer) {
16            System.out.print("Wrong answer. Try again. What is "
17                + number1 + " + " + number2 + "? ");
18            answer = input.nextInt();
19        }
20
21        System.out.println("You got it!");
22    }
23 }
```



```
What is 5 + 9? 12 ↵
Wrong answer. Try again. What is 5 + 9? 34 ↵
Wrong answer. Try again. What is 5 + 9? 14 ↵
You got it!
```

The loop in lines 15–19 repeatedly prompts the user to enter an `answer` when `number1 + number2 != answer` is `true`. Once `number1 + number2 != answer` is `false`, the loop exits.

4.2.1 Case Study: Guessing Numbers

The problem is to guess what number a computer has in mind. You will write a program that randomly generates an integer between `0` and `100`, inclusive. The program prompts the user to enter a number continuously until the number matches the randomly generated number. For each user input, the program tells the user whether the input is too low or too high, so the user can make the next guess intelligently. Here is a sample run:



VideoNote
Guess a number



```

Guess a magic number between 0 and 100
Enter your guess: 50 ↵
Your guess is too high
Enter your guess: 25 ↵
Your guess is too low
Enter your guess: 42 ↵
Your guess is too high
Enter your guess: 39 ↵
Yes, the number is 39

```

The magic number is between `0` and `100`. To minimize the number of guesses, enter `50` first. If your guess is too high, the magic number is between `0` and `49`. If your guess is too low, the magic number is between `51` and `100`. So, you can eliminate half of the numbers from further consideration after one guess.

intelligent guess

How do you write this program? Do you immediately begin coding? No. It is important to *think before coding*. Think how you would solve the problem without writing a program. You need first to generate a random number between `0` and `100`, inclusive, then to prompt the user to enter a guess, and then to compare the guess with the random number.

think before coding

It is a good practice to *code incrementally* one step at a time. For programs involving loops, if you don't know how to write a loop right away, you may first write the code for executing the loop one time, and then figure out how to repeatedly execute the code in a loop. For this program, you may create an initial draft, as shown in Listing 4.2.

code incrementally

LISTING 4.2 `GuessNumberOneTime.java`

```

1  import java.util.Scanner;
2
3  public class GuessNumberOneTime {
4      public static void main(String[] args) {
5          // Generate a random number to be guessed
6          int number = (int)(Math.random() * 101);
7
8          Scanner input = new Scanner(System.in);
9          System.out.println("Guess a magic number between 0 and 100");
10
11         // Prompt the user to guess the number
12         System.out.print("\nEnter your guess: ");
13         int guess = input.nextInt();
14
15         if (guess == number)
16             System.out.println("Yes, the number is " + number);
17         else if (guess > number)
18             System.out.println("Your guess is too high");
19         else

```

generate a number

enter a guess

correct guess?

too high?

```

too low?      20         System.out.println("Your guess is too low");
              21     }
              22     }

```

When you run this program, it prompts the user to enter a guess only once. To let the user enter a guess repeatedly, you may put the code in lines 11–20 in a loop as follows:

```

while (true) {
    // Prompt the user to guess the number
    System.out.print("\nEnter your guess: ");
    guess = input.nextInt();

    if (guess == number)
        System.out.println("Yes, the number is " + number);
    else if (guess > number)
        System.out.println("Your guess is too high");
    else
        System.out.println("Your guess is too low");
} // End of loop

```

This loop repeatedly prompts the user to enter a guess. However, this loop is not correct, because it never terminates. When `guess` matches `number`, the loop should end. So, the loop can be revised as follows:

```

while (guess != number) {
    // Prompt the user to guess the number
    System.out.print("\nEnter your guess: ");
    guess = input.nextInt();

    if (guess == number)
        System.out.println("Yes, the number is " + number);
    else if (guess > number)
        System.out.println("Your guess is too high");
    else
        System.out.println("Your guess is too low");
} // End of loop

```

The complete code is given in Listing 4.3.

LISTING 4.3 GuessNumber.java

```

1  import java.util.Scanner;
2
3  public class GuessNumber {
4      public static void main(String[] args) {
5          // Generate a random number to be guessed
generate a number 6          int number = (int)(Math.random() * 101);
7
8          Scanner input = new Scanner(System.in);
9          System.out.println("Guess a magic number between 0 and 100");
10
11         int guess = -1;
12         while (guess != number) {
13             // Prompt the user to guess the number
14             System.out.print("\nEnter your guess: ");
enter a guess      15             guess = input.nextInt();
16
17             if (guess == number)
18                 System.out.println("Yes, the number is " + number);
19             else if (guess > number)

```

```

20     System.out.println("Your guess is too high");           too high?
21     else
22     System.out.println("Your guess is too low");           too low?
23 } // End of loop
24 }
25 }

```

	line#	number	guess	output
	6	39		
iteration 1	11		-1	
	15		50	
	20			Your guess is too high
iteration 2	15		25	
	22			Your guess is too low
iteration 3	15		42	
	20			Your guess is too high
iteration 4	15		39	
	18			Yes, the number is 39

The program generates the magic number in line 6 and prompts the user to enter a guess continuously in a loop (lines 12–23). For each guess, the program checks whether the guess is correct, too high, or too low (lines 17–22). When the guess is correct, the program exits the loop (line 12). Note that **guess** is initialized to **-1**. Initializing it to a value between **0** and **100** would be wrong, because that could be the number to be guessed.

4.2.2 Loop Design Strategies

Writing a correct loop is not an easy task for novice programmers. Consider three steps when writing a loop.

Step 1: Identify the statements that need to be repeated.

Step 2: Wrap these statements in a loop like this:

```

while (true) {
    Statements;
}

```

Step 3: Code the **loop-continuation-condition** and add appropriate statements for controlling the loop.

```

while (loop-continuation-condition) {
    Statements;
    Additional statements for controlling the loop;
}

```

4.2.3 Case Study: Multiple Subtraction Quiz

The Math subtraction learning tool program in Listing 3.4, `SubtractionQuiz.java`, generates just one question for each run. You can use a loop to generate questions repeatedly. How do you write the code to generate five questions? Follow the loop design strategy. First identify the statements that need to be repeated. These are the statements for obtaining two random numbers, prompting



the user with a subtraction question, and grading the question. Second, wrap the statements in a loop. Third, add a loop control variable and the **loop-continuation-condition** to execute the loop five times.

Listing 4.4 gives a program that generates five questions and, after a student answers all five, reports the number of correct answers. The program also displays the time spent on the test and lists all the questions.

LISTING 4.4 SubtractionQuizLoop.java

```

1  import java.util.Scanner;
2
3  public class SubtractionQuizLoop {
4      public static void main(String[] args) {
5          final int NUMBER_OF_QUESTIONS = 5; // Number of questions
6          int correctCount = 0; // Count the number of correct answers
7          int count = 0; // Count the number of questions
8          long startTime = System.currentTimeMillis();
9          String output = " "; // output string is initially empty
10         Scanner input = new Scanner(System.in);
11
12         while (count < NUMBER_OF_QUESTIONS) {
13             // 1. Generate two random single-digit integers
14             int number1 = (int)(Math.random() * 10);
15             int number2 = (int)(Math.random() * 10);
16
17             // 2. If number1 < number2, swap number1 with number2
18             if (number1 < number2) {
19                 int temp = number1;
20                 number1 = number2;
21                 number2 = temp;
22             }
23
24             // 3. Prompt the student to answer "What is number1 - number2?"
25             System.out.print(
26                 "What is " + number1 + " - " + number2 + "? ";
27             int answer = input.nextInt();
28
29             // 4. Grade the answer and display the result
30             if (number1 - number2 == answer) {
31                 System.out.println("You are correct!");
32                 correctCount++; // Increase the correct answer count
33             }
34             else
35                 System.out.println("Your answer is wrong.\n" + number1
36                     + " - " + number2 + " should be " + (number1 - number2));
37
38             // Increase the question count
39             count++;
40
41             output += "\n" + number1 + "-" + number2 + "=" + answer +
42                 ((number1 - number2 == answer) ? " correct" : " wrong");
43         }
44
45         long endTime = System.currentTimeMillis();
46         long testTime = endTime - startTime;
47
48         System.out.println("Correct count is " + correctCount +
49             "\nTest time is " + testTime / 1000 + " seconds\n" + output);
50     }
51 }

```

get start time

loop

display a question

grade an answer

increase correct count

increase control variable

prepare output

end loop

get end time

test time

display result



```

What is 9 - 2? 7 ↵ Enter
You are correct!

What is 3 - 0? 3 ↵ Enter
You are correct!

What is 3 - 2? 1 ↵ Enter
You are correct!

What is 7 - 4? 4 ↵ Enter
Your answer is wrong.

7 - 4 should be 3
What is 7 - 5? 4 ↵ Enter

Your answer is wrong.
7 - 5 should be 2

Correct count is 3
Test time is 1021 seconds

9-2=7 correct
3-0=3 correct
3-2=1 correct
7-4=4 wrong
7-5=4 wrong

```

The program uses the control variable `count` to control the execution of the loop. `count` is initially `0` (line 7) and is increased by `1` in each iteration (line 39). A subtraction question is displayed and processed in each iteration. The program obtains the time before the test starts in line 8 and the time after the test ends in line 45, and computes the test time in line 46. The test time is in milliseconds and is converted to seconds in line 49.

4.2.4 Controlling a Loop with a Sentinel Value

Another common technique for controlling a loop is to designate a special value when reading and processing a set of values. This special input value, known as a *sentinel value*, signifies the end of the input. A loop that uses a sentinel value to control its execution is called a *sentinel-controlled loop*.

sentinel value

sentinel-controlled loop

Listing 4.5 writes a program that reads and calculates the sum of an unspecified number of integers. The input `0` signifies the end of the input. Do you need to declare a new variable for each input value? No. Just use one variable named `data` (line 12) to store the input value and use a variable named `sum` (line 15) to store the total. Whenever a value is read, assign it to `data` and, if it is not zero, add it to `sum` (line 17).

LISTING 4.5 SentinelValue.java

```

1  import java.util.Scanner;
2
3  public class SentinelValue {
4      /** Main method */
5      public static void main(String[] args) {
6          // Create a Scanner
7          Scanner input = new Scanner(System.in);
8
9          // Read an initial data
10         System.out.print(
11             "Enter an integer (the input ends if it is 0): ";
12         int data = input.nextInt();

```

input

```

13
14 // Keep reading data until the input is 0
15 int sum = 0;
loop 16 while (data != 0) {
17     sum += data;
18
19     // Read the next data
20     System.out.print(
21         "Enter an integer (the input ends if it is 0): ";
22     data = input.nextInt();
23 }
24
end of loop
25 System.out.println("The sum is " + sum);
26 }
27 }
display result

```



```

Enter an integer (the input ends if it is 0): 2 [Enter]
Enter an integer (the input ends if it is 0): 3 [Enter]
Enter an integer (the input ends if it is 0): 4 [Enter]
Enter an integer (the input ends if it is 0): 0 [Enter]
The sum is 9

```



	line#	data	sum	output
	12	2		
	15		0	
iteration 1	17		2	
	22	3		
iteration 2	17		5	
	22	4		
iteration 3	17		9	
	22	0		
	25			The sum is 9

If **data** is not **0**, it is added to **sum** (line 17) and the next item of input data is read (lines 20–22). If **data** is **0**, the loop body is no longer executed and the **while** loop terminates. The input value **0** is the sentinel value for this loop. Note that if the first input read is **0**, the loop never executes, and the resulting sum is **0**.



Caution

Don't use floating-point values for equality checking in a loop control. Because floating-point values are approximations for some values, using them could result in imprecise counter values and inaccurate results.

Consider the following code for computing $1 + 0.9 + 0.8 + \dots + 0.1$:

```

double item = 1; double sum = 0;
while (item != 0) { // No guarantee item will be 0
    sum += item;
    item -= 0.1;
}
System.out.println(sum);

```

Variable `item` starts with `1` and is reduced by `0.1` every time the loop body is executed. The loop should terminate when `item` becomes `0`. However, there is no guarantee that `item` will be exactly `0`, because the floating-point arithmetic is approximated. This loop seems okay on the surface, but it is actually an infinite loop.

numeric error

4.2.5 Input and Output Redirections

In the preceding example, if you have a large number of data to enter, it would be cumbersome to type from the keyboard. You can store the data separated by whitespaces in a text file, say `input.txt`, and run the program using the following command:

```
java SentinelValue < input.txt
```

This command is called *input redirection*. The program takes the input from the file `input.txt` rather than having the user type the data from the keyboard at runtime. Suppose the contents of the file are

```
2 3 4 5 6 7 8 9 12 23 32
23 45 67 89 92 12 34 35 3 1 2 4 0
```

The program should get `sum` to be `518`.

Similarly, there is *output redirection*, which sends the output to a file rather than displaying it on the console. The command for output redirection is:

```
java ClassName > output.txt
```

Input and output redirection can be used in the same command. For example, the following command gets input from `input.txt` and sends output to `output.txt`:

```
java SentinelValue < input.txt > output.txt
```

Try running the program to see what contents are in `output.txt`.

- 4.1** Analyze the following code. Is `count < 100` always `true`, always `false`, or sometimes `true` or sometimes `false` at Point A, Point B, and Point C?

```
int count = 0;
while (count < 100) {
    // Point A
    System.out.println("Welcome to Java!\n");
    count++;
    // Point B
}
// Point C
```



MyProgrammingLab

- 4.2** What is wrong if `guess` is initialized to `0` in line 11 in Listing 4.3?
- 4.3** How many times are the following loop bodies repeated? What is the printout of each loop?

```
int i = 1;
while (i < 10)
    if (i % 2 == 0)
        System.out.println(i);
```

(a)

```
int i = 1;
while (i < 10)
    if (i % 2 == 0)
        System.out.println(i++);
```

(b)

```
int i = 1;
while (i < 10)
    if ((i++) % 2 == 0)
        System.out.println(i);
```

(c)

4.4 Suppose the input is **2 3 4 5 0**. What is the output of the following code?

```
import java.util.Scanner;

public class Test {
    public static void main(String[] args) {

        Scanner input = new Scanner(System.in);

        int number, max;
        number = input.nextInt();
        max = number;

        while (number != 0) {
            number = input.nextInt();
            if (number > max)
                max = number;
        }

        System.out.println("max is " + max);
        System.out.println("number " + number);
    }
}
```

4.5 What is the output of the following code? Explain the reason.

```
int x = 80000000;

while (x > 0)
    x++;

System.out.println("x is " + x);
```

4.3 The do-while Loop



A **do-while** loop is the same as a **while** loop except that it executes the loop body first and then checks the loop continuation condition.

The **do-while** loop is a variation of the **while** loop. Its syntax is:

```
do {
    // Loop body;
    Statement(s);
} while (loop-continuation-condition);
```

Its execution flowchart is shown in Figure 4.2.

The loop body is executed first, and then the **loop-continuation-condition** is evaluated. If the evaluation is **true**, the loop body is executed again; if it is **false**, the **do-while** loop terminates. The difference between a **while** loop and a **do-while** loop is the order in which the **loop-continuation-condition** is evaluated and the loop body executed. You can write a loop using either the **while** loop or the **do-while** loop. Sometimes one is a more convenient choice than the other. For example, you can rewrite the **while** loop in Listing 4.5 using a **do-while** loop, as shown in Listing 4.6.

LISTING 4.6 TestDoWhile.java

```
1 import java.util.Scanner;
2
3 public class TestDoWhile {
```

do-while loop

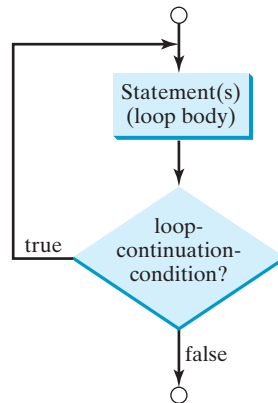


FIGURE 4.2 The **do-while** loop executes the loop body first, then checks the **loop-continuation-condition** to determine whether to continue or terminate the loop.

```

4  /** Main method */
5  public static void main(String[] args) {
6      int data;
7      int sum = 0;
8
9      // Create a Scanner
10     Scanner input = new Scanner(System.in);
11
12     // Keep reading data until the input is 0
13     do {
14         // Read the next data
15         System.out.print(
16             "Enter an integer (the input ends if it is 0): ";
17         data = input.nextInt();
18
19         sum += data;
20     } while (data != 0);
21
22     System.out.println("The sum is " + sum);
23 }
24 }
  
```

loop

end loop



```

Enter an integer (the input ends if it is 0): 3 ↵ Enter
Enter an integer (the input ends if it is 0): 5 ↵ Enter
Enter an integer (the input ends if it is 0): 6 ↵ Enter
Enter an integer (the input ends if it is 0): 0 ↵ Enter
The sum is 14
  
```



Tip

Use the **do-while** loop if you have statements inside the loop that must be executed *at least once*, as in the case of the **do-while** loop in the preceding **TestDownWhile** program. These statements must appear before the loop as well as inside it if you use a **while** loop.



- 4.6** Suppose the input is **2 3 4 5 0**. What is the output of the following code?

```
import java.util.Scanner;

public class Test {
    public static void main(String[] args) {
        Scanner input = new Scanner(System.in);

        int number, max;
        number = input.nextInt();
        max = number;

        do {
            number = input.nextInt();
            if (number > max)
                max = number;
        } while (number != 0);

        System.out.println("max is " + max);
        System.out.println("number " + number);
    }
}
```

- 4.7** What are the differences between a **while** loop and a **do-while** loop? Convert the following **while** loop into a **do-while** loop.

```
Scanner input = new Scanner(System.in);
int sum = 0;
System.out.println("Enter an integer " +
    "(the input ends if it is 0)");
int number = input.nextInt();
while (number != 0) {
    sum += number;
    System.out.println("Enter an integer " +
        "(the input ends if it is 0)");
    number = input.nextInt();
}
```

4.4 The for Loop



A **for** loop has a concise syntax for writing loops.

Often you write a loop in the following common form:

```
i = initialValue; // Initialize loop control variable
while (i < endValue) {
    // Loop body
    ...
    i++; // Adjust loop control variable
}
```

A **for** loop can be used to simplify the preceding loop as:

```
for (i = initialValue; i < endValue; i++) {
    // Loop body
    ...
}
```

In general, the syntax of a **for** loop is:

```
for (initial-action; loop-continuation-condition;
      action-after-each-iteration) {
    // Loop body;
    Statement(s);
}
```

for loop

The flowchart of the **for** loop is shown in Figure 4.3a.

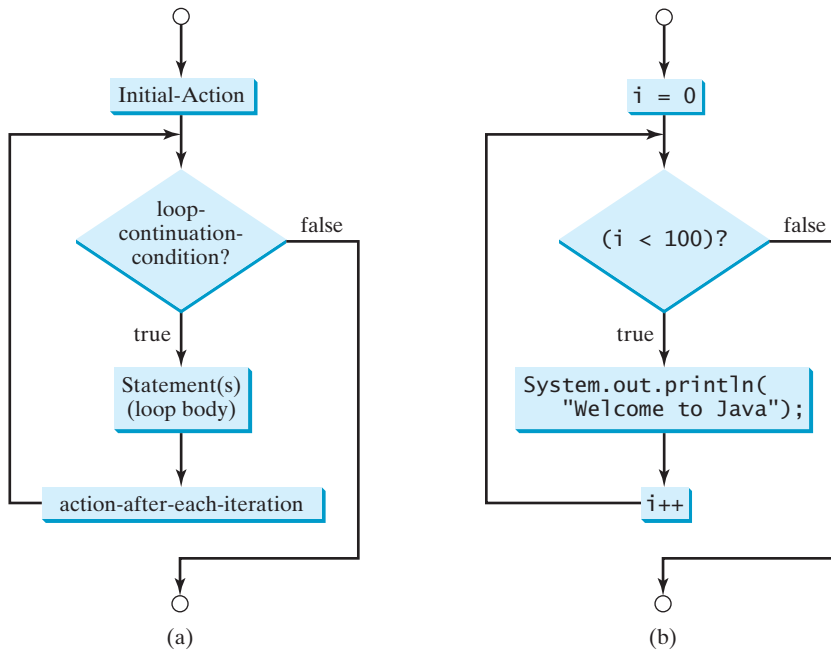


FIGURE 4.3 A **for** loop performs an initial action once, then repeatedly executes the statements in the loop body, and performs an action after an iteration when the **loop-continuation-condition** evaluates to **true**.

The **for** loop statement starts with the keyword **for**, followed by a pair of parentheses enclosing the control structure of the loop. This structure consists of **initial-action**, **loop-continuation-condition**, and **action-after-each-iteration**. The control structure is followed by the loop body enclosed inside braces. The **initial-action**, **loop-continuation-condition**, and **action-after-each-iteration** are separated by semicolons.

A **for** loop generally uses a variable to control how many times the loop body is executed and when the loop terminates. This variable is referred to as a *control variable*. The **initial-action** often initializes a control variable, the **action-after-each-iteration** usually increments or decrements the control variable, and the **loop-continuation-condition** tests whether the control variable has reached a termination value. For example, the following **for** loop prints **Welcome to Java!** a hundred times:

control variable

```
int i;
for (i = 0; i < 100; i++) {
    System.out.println("Welcome to Java!");
}
```

The flowchart of the statement is shown in Figure 4.3b. The **for** loop initializes **i** to **0**, then repeatedly executes the **println** statement and evaluates **i++** while **i** is less than **100**.

initial-action

The **initial-action**, **i = 0**, initializes the control variable, **i**. The **loop-continuation-condition**, **i < 100**, is a Boolean expression. The expression is evaluated right after the initialization and at the beginning of each iteration. If this condition is **true**, the loop body is executed. If it is **false**, the loop terminates and the program control turns to the line following the loop.

action-after-each-iteration

The **action-after-each-iteration**, **i++**, is a statement that adjusts the control variable. This statement is executed after each iteration and increments the control variable. Eventually, the value of the control variable should force the **loop-continuation-condition** to become **false**; otherwise, the loop is infinite.

The loop control variable can be declared and initialized in the **for** loop. Here is an example:

```
for (int i = 0; i < 100; i++) {
    System.out.println("Welcome to Java!");
}
```

omitting braces

If there is only one statement in the loop body, as in this example, the braces can be omitted.

declare control variable



Tip

The control variable must be declared inside the control structure of the loop or before the loop. If the loop control variable is used only in the loop, and not elsewhere, it is good programming practice to declare it in the **initial-action** of the **for** loop. If the variable is declared inside the loop control structure, it cannot be referenced outside the loop. In the preceding code, for example, you cannot reference **i** outside the **for** loop, because it is declared inside the **for** loop.

for loop variations



Note

The **initial-action** in a **for** loop can be a list of zero or more comma-separated variable declaration statements or assignment expressions. For example:

```
for (int i = 0, j = 0; (i + j < 10); i++, j++) {
    // Do something
}
```

The **action-after-each-iteration** in a **for** loop can be a list of zero or more comma-separated statements. For example:

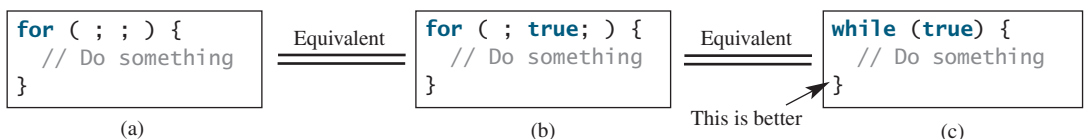
```
for (int i = 1; i < 100; System.out.println(i), i++);
```

This example is correct, but it is a bad example, because it makes the code difficult to read. Normally, you declare and initialize a control variable as an initial action and increment or decrement the control variable as an action after each iteration.



Note

If the **loop-continuation-condition** in a **for** loop is omitted, it is implicitly **true**. Thus the statement given below in (a), which is an infinite loop, is the same as in (b). To avoid confusion, though, it is better to use the equivalent loop in (c).





4.8 Do the following two loops result in the same value in **sum**?

```
for (int i = 0; i < 10; ++i) {
    sum += i;
}
```

(a)

```
for (int i = 0; i < 10; i++) {
    sum += i;
}
```

(b)

4.9 What are the three parts of a **for** loop control? Write a **for** loop that prints the numbers from **1** to **100**.

4.10 Suppose the input is **2 3 4 5 0**. What is the output of the following code?

```
import java.util.Scanner;

public class Test {
    public static void main(String[] args) {
        Scanner input = new Scanner(System.in);

        int number, sum = 0, count;

        for (count = 0; count < 5; count++) {
            number = input.nextInt();
            sum += number;
        }

        System.out.println("sum is " + sum);
        System.out.println("count is " + count);
    }
}
```

4.11 What does the following statement do?

```
for ( ; ; ) {
    // Do something
}
```

4.12 If a variable is declared in the **for** loop control, can it be used after the loop exits?

4.13 Convert the following **for** loop statement to a **while** loop and to a **do-while** loop:

```
long sum = 0;
for (int i = 0; i <= 1000; i++)
    sum = sum + i;
```

4.14 Count the number of iterations in the following loops.

```
int count = 0;
while (count < n) {
    count++;
}
```

(a)

```
for (int count = 0;
     count <= n; count++) {
}
```

(b)

```
int count = 5;
while (count < n) {
    count++;
}
```

(c)

```
int count = 5;
while (count < n) {
    count = count + 3;
}
```

(d)

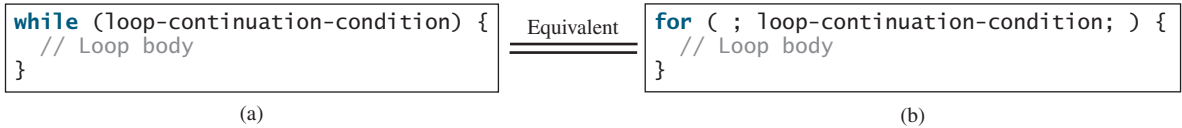
4.5 Which Loop to Use?



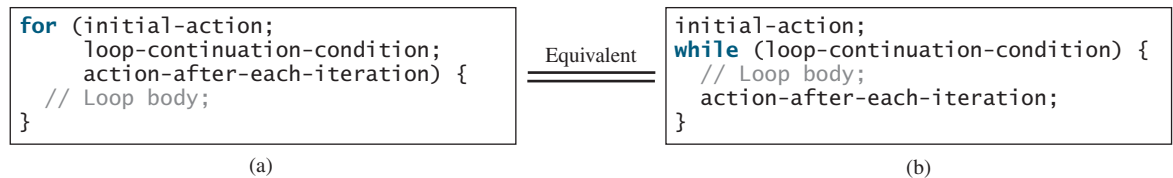
You can use a **for** loop, a **while** loop, or a **do-while** loop, whichever is convenient.

pretest loop
posttest loop

The **while** loop and **for** loop are called *pretest loops* because the continuation condition is checked before the loop body is executed. The **do-while** loop is called a *posttest loop* because the condition is checked after the loop body is executed. The three forms of loop statements—**while**, **do-while**, and **for**—are expressively equivalent; that is, you can write a loop in any of these three forms. For example, a **while** loop in (a) in the following figure can always be converted into the **for** loop in (b).



A **for** loop in (a) in the next figure can generally be converted into the **while** loop in (b) except in certain special cases (see Checkpoint Question 4.23 for such a case).

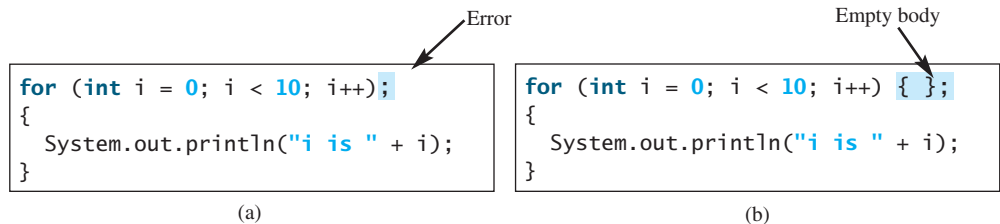


Use the loop statement that is most intuitive and comfortable for you. In general, a **for** loop may be used if the number of repetitions is known in advance, as, for example, when you need to display a message a hundred times. A **while** loop may be used if the number of repetitions is not fixed, as in the case of reading the numbers until the input is 0. A **do-while** loop can be used to replace a **while** loop if the loop body has to be executed before the continuation condition is tested.

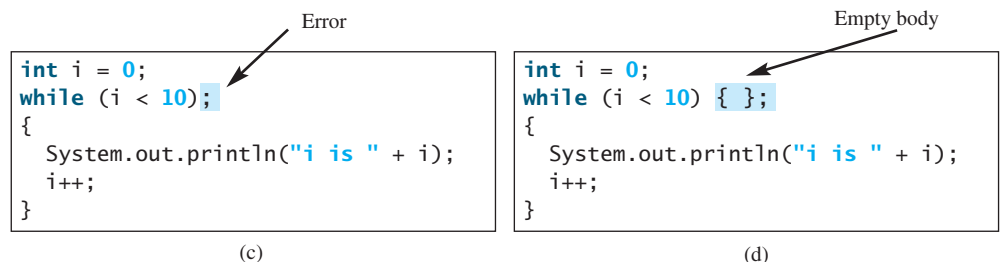


Caution

Adding a semicolon at the end of the **for** clause before the loop body is a common mistake, as shown below in (a). In (a), the semicolon signifies the end of the loop prematurely. The loop body is actually empty, as shown in (b). (a) and (b) are equivalent. Both are incorrect.



Similarly, the loop in (c) is also wrong. (c) is equivalent to (d). Both are incorrect.



These errors often occur when you use the next-line block style. Using the end-of-line block style can avoid errors of this type.

In the case of the **do-while** loop, the semicolon is needed to end the loop.

```
int i = 0;
do {
    System.out.println("i is " + i);
    i++;
} while (i < 10);
```

Correct

4.15 Can you convert a **for** loop to a **while** loop? List the advantages of using **for** loops.

4.16 Can you always convert a **while** loop into a **for** loop? Convert the following **while** loop into a **for** loop.

```
int i = 1;
int sum = 0;
while (sum < 10000) {
    sum = sum + i;
    i++;
}
```

4.17 Identify and fix the errors in the following code:

```
1 public class Test {
2     public void main(String[] args) {
3         for (int i = 0; i < 10; i++);
4             sum += i;
5
6         if (i < j);
7             System.out.println(i)
8         else
9             System.out.println(j);
10
11        while (j < 10);
12        {
13            j++;
14        }
15
16        do {
17            j++;
18        } while (j < 10)
19    }
20 }
```

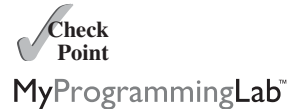
4.18 What is wrong with the following programs?

```
1 public class ShowErrors {
2     public static void main(String[] args) {
3         int i;
4         int j = 5;
5
6         if (j > 3)
7             System.out.println(i + 4);
8     }
9 }
```

(a)

```
1 public class ShowErrors {
2     public static void main(String[] args) {
3         for (int i = 0; i < 10; i++);
4             System.out.println(i + 4);
5     }
6 }
```

(b)



4.6 Nested Loops



A loop can be nested inside another loop.

Nested loops consist of an outer loop and one or more inner loops. Each time the outer loop is repeated, the inner loops are reentered, and started anew.

Listing 4.7 presents a program that uses nested **for** loops to display a multiplication table.

nested loop

LISTING 4.7 MultiplicationTable.java

table title

outer loop

inner loop

```

1  public class MultiplicationTable {
2      /** Main method */
3      public static void main(String[] args) {
4          // Display the table heading
5          System.out.println("          Multiplication Table");
6
7          // Display the number title
8          System.out.print("          ");
9          for (int j = 1; j <= 9; j++)
10             System.out.print("    " + j);
11
12         System.out.println("\n-----");
13
14         // Display table body
15         for (int i = 1; i <= 9; i++) {
16             System.out.print(i + " | ");
17             for (int j = 1; j <= 9; j++) {
18                 // Display the product and align properly
19                 System.out.printf("%4d", i * j);
20             }
21             System.out.println();
22         }
23     }
24 }

```



Multiplication Table									
	1	2	3	4	5	6	7	8	9
1	1	2	3	4	5	6	7	8	9
2	2	4	6	8	10	12	14	16	18
3	3	6	9	12	15	18	21	24	27
4	4	8	12	16	20	24	28	32	36
5	5	10	15	20	25	30	35	40	45
6	6	12	18	24	30	36	42	48	54
7	7	14	21	28	35	42	49	56	63
8	8	16	24	32	40	48	56	64	72
9	9	18	27	36	45	54	63	72	81

The program displays a title (line 5) on the first line in the output. The first **for** loop (lines 9–10) displays the numbers **1** through **9** on the second line. A dashed (–) line is displayed on the third line (line 12).

The next loop (lines 15–22) is a nested **for** loop with the control variable **i** in the outer loop and **j** in the inner loop. For each **i**, the product **i * j** is displayed on a line in the inner loop, with **j** being **1, 2, 3, ..., 9**.

**Note**

Be aware that a nested loop may take a long time to run. Consider the following loop nested in three levels:

```
for (int i = 0; i < 10000; i++)
    for (int j = 0; j < 10000; j++)
        for (int k = 0; k < 10000; k++)
            Perform an action
```

The action is performed one trillion times. If it takes 1 microsecond to perform the action, the total time to run the loop would be more than 277 hours. Note that 1 microsecond is one millionth (10^{-6}) of a second.

4.19 How many times is the `println` statement executed?

```
for (int i = 0; i < 10; i++)
    for (int j = 0; j < i; j++)
        System.out.println(i * j)
```



MyProgrammingLab™

4.20 Show the output of the following programs. (*Hint*: Draw a table and list the variables in the columns to trace these programs.)

```
public class Test {
    /** Main method */
    public static void main(String[] args) {
        for (int i = 1; i < 5; i++) {
            int j = 0;
            while (j < i) {
                System.out.print(j + " ");
                j++;
            }
        }
    }
}
```

(a)

```
public class Test {
    /** Main method */
    public static void main(String[] args) {
        int i = 0;
        while (i < 5) {
            for (int j = i; j > 1; j--)
                System.out.print(j + " ");
            System.out.println("*****");
            i++;
        }
    }
}
```

(b)

```
public class Test {
    public static void main(String[] args) {
        int i = 5;
        while (i >= 1) {
            int num = 1;
            for (int j = 1; j <= i; j++) {
                System.out.print(num + "xxx");
                num *= 2;
            }

            System.out.println();
            i--;
        }
    }
}
```

(c)

```
public class Test {
    public static void main(String[] args) {
        int i = 1;
        do {
            int num = 1;
            for (int j = 1; j <= i; j++) {
                System.out.print(num + "G");
                num += 2;
            }

            System.out.println();
            i++;
        } while (i <= 5);
    }
}
```

(d)

4.7 Minimizing Numeric Errors



Using floating-point numbers in the loop continuation condition may cause numeric errors.

Numeric errors involving floating-point numbers are inevitable. This section discusses how to minimize such errors through an example.

Listing 4.8 presents an example summing a series that starts with **0.01** and ends with **1.0**. The numbers in the series will increment by **0.01**, as follows: **0.01 + 0.02 + 0.03**, and so on.

LISTING 4.8 TestSum.java

```

1 public class TestSum {
2     public static void main(String[] args) {
3         // Initialize sum
4         float sum = 0;
5
6         // Add 0.01, 0.02, ..., 0.99, 1 to sum
7         for (float i = 0.01f; i <= 1.0f; i = i + 0.01f)
8             sum += i;
9
10        // Display result
11        System.out.println("The sum is " + sum);
12    }
13 }
```

loop



The sum is 50.499985

The **for** loop (lines 7–8) repeatedly adds the control variable **i** to **sum**. This variable, which begins with **0.01**, is incremented by **0.01** after each iteration. The loop terminates when **i** exceeds **1.0**.

The **for** loop initial action can be any statement, but it is often used to initialize a control variable. From this example, you can see that a control variable can be a **float** type. In fact, it can be any data type.

The exact **sum** should be **50.50**, but the answer is **50.499985**. The result is imprecise because computers use a fixed number of bits to represent floating-point numbers, and thus they cannot represent some floating-point numbers exactly. If you change **float** in the program to **double**, as follows, you should see a slight improvement in precision, because a **double** variable holds 64 bits, whereas a **float** variable holds 32 bits.

```

// Initialize sum
double sum = 0;

// Add 0.01, 0.02, ..., 0.99, 1 to sum
for (double i = 0.01; i <= 1.0; i = i + 0.01)
    sum += i;
```

However, you will be stunned to see that the result is actually **49.50000000000003**. What went wrong? If you display **i** for each iteration in the loop, you will see that the last **i** is slightly larger than **1** (not exactly **1**). This causes the last **i** not to be added into **sum**. The fundamental problem is that the floating-point numbers are represented by approximation. To fix the problem, use an integer count to ensure that all the numbers are added to **sum**. Here is the new loop:

```

double currentValue = 0.01;

for (int count = 0; count < 100; count++) {
```



VideoNote

Minimize numeric errors

double precision

numeric error

```

    sum += currentValue;
    currentValue += 0.01;
}

```

After this loop, `sum` is `50.50000000000003`. This loop adds the numbers from smallest to biggest. What happens if you add numbers from biggest to smallest (i.e., `1.0`, `0.99`, `0.98`, . . . , `0.02`, `0.01` in this order) as follows:

```

double currentValue = 1.0;

for (int count = 0; count < 100; count++) {
    sum += currentValue;
    currentValue -= 0.01;
}

```

After this loop, `sum` is `50.49999999999995`. Adding from biggest to smallest is less accurate than adding from smallest to biggest. This phenomenon is an artifact of the finite-precision arithmetic. Adding a very small number to a very big number can have no effect if the result requires more precision than the variable can store. For example, the inaccurate result of `100000000.0 + 0.000000001` is `100000000.0`. To obtain more accurate results, carefully select the order of computation. Adding smaller numbers before bigger numbers is one way to minimize errors.

avoiding numeric error

4.8 Case Studies

Loops are fundamental in programming. The ability to write loops is essential in learning Java programming.



If you can write programs using loops, you know how to program! For this reason, this section presents three additional examples of solving problems using loops.

4.8.1 Case Study: Finding the Greatest Common Divisor

The greatest common divisor (gcd) of the two integers `4` and `2` is `2`. The greatest common divisor of the two integers `16` and `24` is `8`. How do you find the greatest common divisor? Let the two input integers be `n1` and `n2`. You know that number `1` is a common divisor, but it may not be the greatest common divisor. So, you can check whether `k` (for `k = 2, 3, 4`, and so on) is a common divisor for `n1` and `n2`, until `k` is greater than `n1` or `n2`. Store the common divisor in a variable named `gcd`. Initially, `gcd` is `1`. Whenever a new common divisor is found, it becomes the new gcd. When you have checked all the possible common divisors from `2` up to `n1` or `n2`, the value in variable `gcd` is the greatest common divisor. The idea can be translated into the following loop:

gcd

```

int gcd = 1; // Initial gcd is 1
int k = 2; // Possible gcd

while (k <= n1 && k <= n2) {
    if (n1 % k == 0 && n2 % k == 0)
        gcd = k; // Update gcd
    k++; // Next possible gcd
}

```

```
// After the loop, gcd is the greatest common divisor for n1 and n2
```

Listing 4.9 presents the program that prompts the user to enter two positive integers and finds their greatest common divisor.

LISTING 4.9 GreatestCommonDivisor.java

```

1  import java.util.Scanner;
2
3  public class GreatestCommonDivisor {
4      /** Main method */
5      public static void main(String[] args) {
6          // Create a Scanner
7          Scanner input = new Scanner(System.in);
8
9          // Prompt the user to enter two integers
10         System.out.print("Enter first integer: ");
input    11         int n1 = input.nextInt();
input    12         System.out.print("Enter second integer: ");
13         int n2 = input.nextInt();
14
gcd       15         int gcd = 1; // Initial gcd is 1
16         int k = 2; // Possible gcd
check divisor 17         while (k <= n1 && k <= n2) {
18             if (n1 % k == 0 && n2 % k == 0)
19                 gcd = k; // Update gcd
20             k++;
21         }
22
output   23         System.out.println("The greatest common divisor for " + n1 +
24             " and " + n2 + " is " + gcd);
25     }
26 }

```



```

Enter first integer: 125 ↵ Enter
Enter second integer: 2525 ↵ Enter
The greatest common divisor for 125 and 2525 is 25

```

think before you type

How would you write this program? Would you immediately begin to write the code? No. It is important to *think before you type*. Thinking enables you to generate a logical solution for the problem without concern about how to write the code. Once you have a logical solution, type the code to translate the solution into a Java program. The translation is not unique. For example, you could use a **for** loop to rewrite the code as follows:

```

for (int k = 2; k <= n1 && k <= n2; k++) {
    if (n1 % k == 0 && n2 % k == 0)
        gcd = k;
}

```

multiple solutions

A problem often has multiple solutions, and the gcd problem can be solved in many ways. Programming Exercise 4.14 suggests another solution. A more efficient solution is to use the classic Euclidean algorithm (see www.cut-the-knot.org/blue/Euclid.shtml for more information).

erroneous solutions

You might think that a divisor for a number **n1** cannot be greater than **n1 / 2** and would attempt to improve the program using the following loop:

```

for (int k = 2; k <= n1 / 2 && k <= n2 / 2; k++) {
    if (n1 % k == 0 && n2 % k == 0)
        gcd = k;
}

```


This revision is wrong. Can you find the reason? See Checkpoint Question 4.21 for the answer.

4.8.2 Case Study: Predicting the Future Tuition

Suppose that the tuition for a university is **\$10,000** this year and tuition increases **7%** every year. In how many years will the tuition be doubled?

Before you can write a program to solve this problem, first consider how to solve it by hand. The tuition for the second year is the tuition for the first year * **1.07**. The tuition for a future year is the tuition of its preceding year * **1.07**. Thus, the tuition for each year can be computed as follows:

```
double tuition = 10000;   int year = 0;   // Year 0
tuition = tuition * 1.07; year++;         // Year 1
tuition = tuition * 1.07; year++;         // Year 2
tuition = tuition * 1.07; year++;         // Year 3
...
```

Keep computing the tuition for a new year until it is at least **20000**. By then you will know how many years it will take for the tuition to be doubled. You can now translate the logic into the following loop:

```
double tuition = 10000;   // Year 0
int year = 0;
while (tuition < 20000) {
    tuition = tuition * 1.07;
    year++;
}
```

The complete program is shown in Listing 4.10.

LISTING 4.10 FutureTuition.java

```
1 public class FutureTuition {
2     public static void main(String[] args) {
3         double tuition = 10000;   // Year 0
4         int year = 0;
5         while (tuition < 20000) {
6             tuition = tuition * 1.07;
7             year++;
8         }
9
10        System.out.println("Tuition will be doubled in "
11            + year + " years");
12        System.out.printf("Tuition will be %.2f in %1d years",
13            tuition, year);
14    }
15 }
```

loop
next year's tuition

```
Tuition will be doubled in 11 years
Tuition will be $21048.52 in 11 years
```

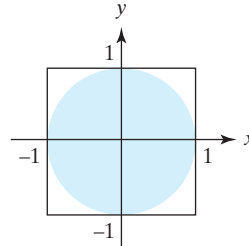


The **while** loop (lines 5–8) is used to repeatedly compute the tuition for a new year. The loop terminates when the tuition is greater than or equal to **20000**.

4.8.3 Case Study: Monte Carlo Simulation

Monte Carlo simulation uses random numbers and probability to solve problems. This method has a wide range of applications in computational mathematics, physics, chemistry, and finance. This section gives an example of using Monte Carlo simulation for estimating π .

To estimate π using the Monte Carlo method, draw a circle with its bounding square as shown below.



Assume the radius of the circle is **1**. Therefore, the circle area is π and the square area is **4**. Randomly generate a point in the square. The probability for the point to fall in the circle is $\text{circleArea} / \text{squareArea} = \pi / 4$.

Write a program that randomly generates 1,000,000 points in the square and let **numberOfHits** denote the number of points that fall in the circle. Thus, **numberOfHits** is approximately $1000000 * (\pi / 4)$. π can be approximated as $4 * \text{numberOfHits} / 1000000$. The complete program is shown in Listing 4.11.

LISTING 4.11 MonteCarloSimulation.java

```

1  public class MonteCarloSimulation {
2      public static void main(String[] args) {
3          final int NUMBER_OF_TRIALS = 1000000;
4          int numberOfHits = 0;
5
6          for (int i = 0; i < NUMBER_OF_TRIALS; i++) {
7              double x = Math.random() * 2.0 - 1;
8              double y = Math.random() * 2.0 - 1;
9              if (x * x + y * y <= 1)
10                 numberOfHits++;
11         }
12
13         double pi = 4.0 * numberOfHits / NUMBER_OF_TRIALS;
14         System.out.println("PI is " + pi);
15     }
16 }

```

generate random points

check inside circle

estimate pi



PI is 3.14124

The program repeatedly generates a random point (x, y) in the square in lines 7–8:

```

double x = Math.random() * 2.0 - 1;
double y = Math.random() * 2.0 - 1;

```

If $x^2 + y^2 \leq 1$, the point is inside the circle and **numberOfHits** is incremented by **1**. π is approximately $4 * \text{numberOfHits} / \text{NUMBER_OF_TRIALS}$ (line 13).

4.21 Will the program work if `n1` and `n2` are replaced by `n1 / 2` and `n2 / 2` in line 17 in Listing 4.9?



MyProgrammingLab™

4.9 Keywords *break* and *continue*

The *break* and *continue* keywords provide additional controls in a loop.



Pedagogical Note

Two keywords, *break* and *continue*, can be used in loop statements to provide additional controls. Using *break* and *continue* can simplify programming in some cases. Overusing or improperly using them, however, can make programs difficult to read and debug. (Note to instructors: You may skip this section without affecting students' understanding of the rest of the book.)

You have used the keyword *break* in a *switch* statement. You can also use *break* in a loop to immediately terminate the loop. Listing 4.12 presents a program to demonstrate the effect of using *break* in a loop.

break statement

LISTING 4.12 TestBreak.java

```

1 public class TestBreak {
2     public static void main(String[] args) {
3         int sum = 0;
4         int number = 0;
5
6         while (number < 20) {
7             number++;
8             sum += number;
9             if (sum >= 100)
10                break;
11        }
12
13        System.out.println("The number is " + number);
14        System.out.println("The sum is " + sum);
15    }
16 }
```

break

```
The number is 14
The sum is 105
```



The program in Listing 4.12 adds integers from **1** to **20** in this order to *sum* until *sum* is greater than or equal to **100**. Without the *if* statement (line 9), the program calculates the sum of the numbers from **1** to **20**. But with the *if* statement, the loop terminates when *sum* becomes greater than or equal to **100**. Without the *if* statement, the output would be:

```
The number is 20
The sum is 210
```



You can also use the *continue* keyword in a loop. When it is encountered, it ends the current iteration and program control goes to the end of the loop body. In other words, *continue* breaks out of an iteration while the *break* keyword breaks out of a loop. Listing 4.13 presents a program to demonstrate the effect of using *continue* in a loop.

continue statement

LISTING 4.13 TestContinue.java

```

1 public class TestContinue {
2     public static void main(String[] args) {
3         int sum = 0;
4         int number = 0;
5
6         while (number < 20) {
7             number++;
8             if (number == 10 || number == 11)
9                 continue;
10            sum += number;
11        }
12
13        System.out.println("The sum is " + sum);
14    }
15 }

```

continue



The sum is 189

The program in Listing 4.13 adds integers from **1** to **20** except **10** and **11** to **sum**. With the **if** statement in the program (line 8), the **continue** statement is executed when **number** becomes **10** or **11**. The **continue** statement ends the current iteration so that the rest of the statement in the loop body is not executed; therefore, **number** is not added to **sum** when it is **10** or **11**. Without the **if** statement in the program, the output would be as follows:



The sum is 210

In this case, all of the numbers are added to **sum**, even when **number** is **10** or **11**. Therefore, the result is **210**, which is **21** more than it was with the **if** statement.

**Note**

The **continue** statement is always inside a loop. In the **while** and **do-while** loops, the **loop-continuation-condition** is evaluated immediately after the **continue** statement. In the **for** loop, the **action-after-each-iteration** is performed, then the **loop-continuation-condition** is evaluated, immediately after the **continue** statement.

You can always write a program without using **break** or **continue** in a loop (see Checkpoint Question 4.24). In general, though, using **break** and **continue** is appropriate if it simplifies coding and makes programs easier to read.

Suppose you need to write a program to find the smallest factor other than **1** for an integer **n** (assume **n >= 2**). You can write a simple and intuitive code using the **break** statement as follows:

```

int factor = 2;
while (factor <= n) {
    if (n % factor == 0)
        break;
    factor++;
}

```

```
System.out.println("The smallest factor other than 1 for "
    + n + " is " + factor);
```

You may rewrite the code without using **break** as follows:

```
boolean found = false;
int factor = 2;
while (factor <= n && !found) {
    if (n % factor == 0)
        found = true;
    else
        factor++;
}
System.out.println("The smallest factor other than 1 for "
    + n + " is " + factor);
```

Obviously, the **break** statement makes this program simpler and easier to read in this case. However, you should use **break** and **continue** with caution. Too many **break** and **continue** statements will produce a loop with many exit points and make the program difficult to read.



Note

Some programming languages have a **goto** statement. The **goto** statement indiscriminately transfers control to any statement in the program and executes it. This makes your program vulnerable to errors. The **break** and **continue** statements in Java are different from **goto** statements. They operate only in a loop or a **switch** statement. The **break** statement breaks out of the loop, and the **continue** statement breaks out of the current iteration in the loop.

goto

4.22 What is the keyword **break** for? What is the keyword **continue** for? Will the following programs terminate? If so, give the output.



MyProgrammingLab™

```
int balance = 10;
while (true) {
    if (balance < 9)
        break;
    balance = balance - 9;
}
System.out.println("Balance is "
    + balance);
```

(a)

```
int balance = 10;
while (true) {
    if (balance < 9)
        continue;
    balance = balance - 9;
}
System.out.println("Balance is "
    + balance);
```

(b)

4.23 The **for** loop on the left is converted into the **while** loop on the right. What is wrong? Correct it.

```
for (int i = 0; i < 4; i++) {
    if (i % 3 == 0) continue;
    sum += i;
}
```

Converted
Wrong conversion

```
int i = 0;
while (i < 4) {
    if (i % 3 == 0) continue;
    sum += i;
    i++;
}
```

- 4.24** Rewrite the programs `TestBreak` and `TestContinue` in Listings 4.12 and 4.13 without using `break` and `continue`.
- 4.25** After the `break` statement in (a) is executed in the following loop, which statement is executed? Show the output. After the `continue` statement in (b) is executed in the following loop, which statement is executed? Show the output.

```
for (int i = 1; i < 4; i++) {
    for (int j = 1; j < 4; j++) {
        if (i * j > 2)
            break;

        System.out.println(i * j);
    }

    System.out.println(i);
}
```

(a)

```
for (int i = 1; i < 4; i++) {
    for (int j = 1; j < 4; j++) {
        if (i * j > 2)
            continue;

        System.out.println(i * j);
    }

    System.out.println(i);
}
```

(b)

4.10 Case Study: Displaying Prime Numbers



This section presents a program that displays the first fifty prime numbers in five lines, each containing ten numbers.

An integer greater than **1** is *prime* if its only positive divisor is **1** or itself. For example, **2**, **3**, **5**, and **7** are prime numbers, but **4**, **6**, **8**, and **9** are not.

The problem is to display the first 50 prime numbers in five lines, each of which contains ten numbers. The problem can be broken into the following tasks:

- Determine whether a given number is prime.
- For `number = 2, 3, 4, 5, 6, ...`, test whether it is prime.
- Count the prime numbers.
- Display each prime number, and display ten numbers per line.

Obviously, you need to write a loop and repeatedly test whether a new `number` is prime. If the `number` is prime, increase the count by **1**. The `count` is **0** initially. When it reaches **50**, the loop terminates.

Here is the algorithm for the problem:

```
Set the number of prime numbers to be printed as
  a constant NUMBER_OF_PRIMES;
Use count to track the number of prime numbers and
  set an initial count to 0;
Set an initial number to 2;
```

```
while (count < NUMBER_OF_PRIMES) {
    Test whether number is prime;

    if number is prime {
        Display the prime number and increase the count;
    }

    Increment number by 1;
}
```

To test whether a number is prime, check whether it is divisible by **2, 3, 4**, and so on up to **number/2**. If a divisor is found, the number is not a prime. The algorithm can be described as follows:

```
Use a boolean variable isPrime to denote whether
the number is prime; Set isPrime to true initially;

for (int divisor = 2; divisor <= number / 2; divisor++) {
    if (number % divisor == 0) {
        Set isPrime to false
        Exit the loop;
    }
}
```

The complete program is given in Listing 4.14.

LISTING 4.14 PrimeNumber.java

```
1 public class PrimeNumber {
2     public static void main(String[] args) {
3         final int NUMBER_OF_PRIMES = 50; // Number of primes to display
4         final int NUMBER_OF_PRIMES_PER_LINE = 10; // Display 10 per line
5         int count = 0; // Count the number of prime numbers
6         int number = 2; // A number to be tested for primeness
7
8         System.out.println("The first 50 prime numbers are \n");
9
10        // Repeatedly find prime numbers
11        while (count < NUMBER_OF_PRIMES) {                                count prime numbers
12            // Assume the number is prime
13            boolean isPrime = true; // Is the current number prime?
14
15            // Test whether number is prime
16            for (int divisor = 2; divisor <= number / 2; divisor++) {      check primeness
17                if (number % divisor == 0) { // If true, number is not prime
18                    isPrime = false; // Set isPrime to false
19                    break; // Exit the for loop                               exit loop
20                }
21            }
22
23            // Display the prime number and increase the count
24            if (isPrime) {                                                display if prime
25                count++; // Increase the count
26
27                if (count % NUMBER_OF_PRIMES_PER_LINE == 0) {
28                    // Display the number and advance to the new line
29                    System.out.println(number);
30                }
31                else
32                    System.out.print(number + " ");
33            }
34
35            // Check if the next number is prime
36            number++;
37        }
38    }
39 }
```



```
The first 50 prime numbers are
2 3 5 7 11 13 17 19 23 29
31 37 41 43 47 53 59 61 67 71
73 79 83 89 97 101 103 107 109 113
127 131 137 139 149 151 157 163 167 173
179 181 191 193 197 199 211 223 227 229
```

subproblem

This is a complex program for novice programmers. The key to developing a programmatic solution for this problem, and for many other problems, is to break it into subproblems and develop solutions for each of them in turn. Do not attempt to develop a complete solution in the first trial. Instead, begin by writing the code to determine whether a given number is prime, then expand the program to test whether other numbers are prime in a loop.

To determine whether a number is prime, check whether it is divisible by a number between **2** and **number/2** inclusive (lines 16–21). If so, it is not a prime number (line 18); otherwise, it is a prime number. For a prime number, display it. If the count is divisible by **10** (lines 27–30), advance to a new line. The program ends when the count reaches **50**.

The program uses the **break** statement in line 19 to exit the **for** loop as soon as the number is found to be a nonprime. You can rewrite the loop (lines 16–21) without using the **break** statement, as follows:

```
for (int divisor = 2; divisor <= number / 2 && isPrime;
    divisor++) {
    // If true, the number is not prime
    if (number % divisor == 0) {
        // Set isPrime to false, if the number is not prime
        isPrime = false;
    }
}
```

However, using the **break** statement makes the program simpler and easier to read in this case.

4.1.1 Controlling a Loop with a Confirmation Dialog



You can use a confirmation dialog to prompt the user to confirm whether to continue or exit a loop.

confirmation dialog

A sentinel-controlled loop can be implemented using a confirmation dialog. The answers *Yes* or *No* continue or terminate the loop. The template of the loop may look as follows:

```
int option = JOptionPane.YES_OPTION;
while (option == JOptionPane.YES_OPTION) {
    System.out.println("continue loop");
    option = JOptionPane.showConfirmDialog(null, "Continue?");
}
```

Listing 4.15 rewrites Listing 4.5, `SentinelValue.java`, using a confirmation dialog box. A sample run is shown in Figure 4.4.

LISTING 4.15 SentinelValueUsingConfirmationDialog.java

```
1 import javax.swing.JOptionPane;
2
3 public class SentinelValueUsingConfirmationDialog {
4     public static void main(String[] args) {
5         int sum = 0;
```



```

6
7 // Keep reading data until the user answers No
8 int option = JOptionPane.YES_OPTION;
9 while (option == JOptionPane.YES_OPTION) {
10 // Read the next data
11 String dataString = JOptionPane.showInputDialog(
12     "Enter an integer: ");
13 int data = Integer.parseInt(dataString);
14
15 sum += data;
16
17 option = JOptionPane.showConfirmDialog(null, "Continue?");
18 }
19
20 JOptionPane.showMessageDialog(null, "The sum is " + sum);
21 }
22 }

```

confirmation option
check option
input dialog
confirmation dialog
message dialog

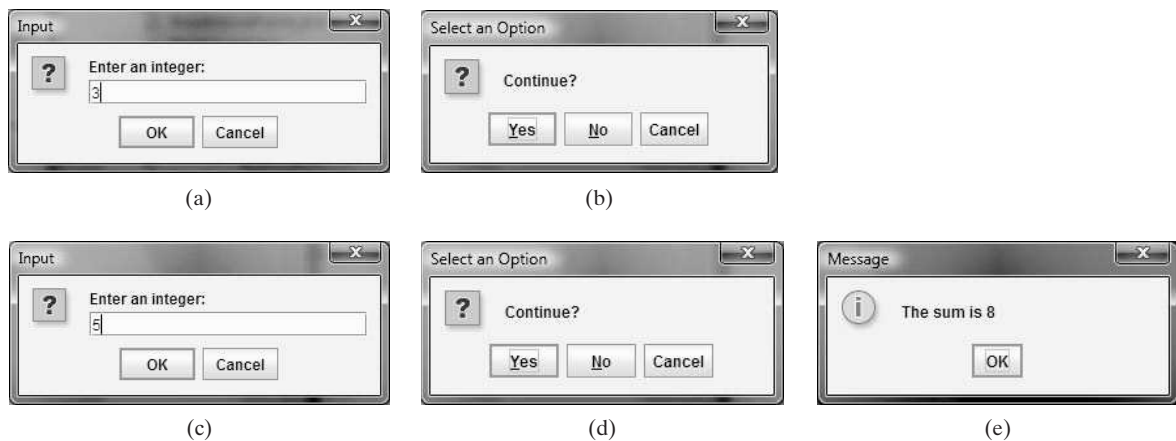


FIGURE 4.4 The user enters 3 in (a), clicks Yes in (b), enters 5 in (c), clicks No in (d), and the result is shown in (e).

The program displays an input dialog to prompt the user to enter an integer (line 11) and adds it to `sum` (line 15). Line 17 displays a confirmation dialog to let the user decide whether to continue the input. If the user clicks *Yes*, the loop continues; otherwise, the loop exits. Finally, the program displays the result in a message dialog box (line 20).

The `showConfirmDialog` method (line 17) returns an integer `JOptionPane.YES_OPTION`, `JOptionPane.NO_OPTION`, or `JOptionPane.CANCEL_OPTION`, if the user clicks *Yes*, *No*, or *Cancel*. The return value is assigned to the variable `option` (line 17). If this value is `JOptionPane.YES_OPTION`, the loop continues (line 9).

KEY TERMS

break statement	159	loop body	134
continue statement	159	nested loop	152
do-while loop	144	off-by-one error	136
for loop	147	output redirection	143
infinite loop	136	posttest loop	150
input redirection	143	pretest loop	150
iteration	134	sentinel value	141
loop	134	while loop	134

CHAPTER SUMMARY

1. There are three types of repetition statements: the **while** loop, the **do-while** loop, and the **for** loop.
2. The part of the loop that contains the statements to be repeated is called the *loop body*.
3. A one-time execution of a loop body is referred to as an *iteration of the loop*.
4. An *infinite loop* is a loop statement that executes infinitely.
5. In designing loops, you need to consider both the *loop control structure* and the loop body.
6. The **while** loop checks the **loop-continuation-condition** first. If the condition is **true**, the loop body is executed; if it is **false**, the loop terminates.
7. The **do-while** loop is similar to the **while** loop, except that the **do-while** loop executes the loop body first and then checks the **loop-continuation-condition** to decide whether to continue or to terminate.
8. The **while** loop and the **do-while** loop often are used when the number of repetitions is not predetermined.
9. A *sentinel value* is a special value that signifies the end of the loop.
10. The **for** loop generally is used to execute a loop body a predictable number of times; this number is not determined by the loop body.
11. The **for** loop control has three parts. The first part is an initial action that often initializes a control variable. The second part, the **loop-continuation-condition**, determines whether the loop body is to be executed. The third part is executed after each iteration and is often used to adjust the control variable. Usually, the loop control variables are initialized and changed in the control structure.
12. The **while** loop and **for** loop are called *pretest loops* because the continuation condition is checked before the loop body is executed.
13. The **do-while** loop is called a *posttest loop* because the condition is checked after the loop body is executed.
14. Two keywords, **break** and **continue**, can be used in a loop.
15. The **break** keyword immediately ends the innermost loop, which contains the break.
16. The **continue** keyword only ends the current iteration.

TEST QUESTIONS

Do the test questions for this chapter online at www.cs.armstrong.edu/liang/intro9e/test.html.

PROGRAMMING EXERCISES



Pedagogical Note

Read each problem several times until you understand it. Think how to solve the problem before starting to write code. Translate your logic into a program.

A problem often can be solved in many different ways. Students are encouraged to explore various solutions.

MyProgrammingLab™

read and think before coding

explore solutions

Sections 4.2–4.7

- *4.1** (*Count positive and negative numbers and compute the average of numbers*) Write a program that reads an unspecified number of integers, determines how many positive and negative values have been read, and computes the total and average of the input values (not counting zeros). Your program ends with the input **0**. Display the average as a floating-point number. Here is a sample run:

```
Enter an integer, the input ends if it is 0: 1 2 -1 3 0 ↵ Enter
The number of positives is 3
The number of negatives is 1
The total is 5
The average is 1.25
```



```
Enter an integer, the input ends if it is 0: 0 ↵ Enter
No numbers are entered except 0
```



- 4.2** (*Repeat additions*) Listing 4.4, `SubtractionQuizLoop.java`, generates five random subtraction questions. Revise the program to generate ten random addition questions for two integers between **1** and **15**. Display the correct count and test time.
- 4.3** (*Conversion from kilograms to pounds*) Write a program that displays the following table (note that **1** kilogram is **2.2** pounds):

Kilograms	Pounds
1	2.2
3	6.6
...	
197	433.4
199	437.8

- 4.4** (*Conversion from miles to kilometers*) Write a program that displays the following table (note that 1 mile is 1.609 kilometers):

Miles	Kilometers
1	1.609
2	3.218
...	
9	14.481
10	16.090

- 4.5** (*Conversion from kilograms to pounds and pounds to kilograms*) Write a program that displays the following two tables side by side (note that 1 kilogram is 2.2 pounds and that 1 pound is .453 kilograms):

Kilograms	Pounds		Pounds	Kilograms
1	2.2		20	9.09
3	6.6		25	11.36
...				
197	433.4		510	231.82
199	437.8		515	234.09

- 4.6** (*Conversion from miles to kilometers*) Write a program that displays the following two tables side by side (note that 1 mile is 1.609 kilometers and that 1 kilometer is .621 miles):

Miles	Kilometers		Kilometers	Miles
1	1.609		20	12.430
2	3.218		25	15.538
...				
9	14.481		60	37.290
10	16.090		65	40.398

- **4.7** (*Financial application: compute future tuition*) Suppose that the tuition for a university is \$10,000 this year and increases 5% every year. Write a program that computes the tuition in ten years and the total cost of four years' worth of tuition starting ten years from now.
- 4.8** (*Find the highest score*) Write a program that prompts the user to enter the number of students and each student's name and score, and finally displays the name of the student with the highest score.
- *4.9** (*Find the two highest scores*) Write a program that prompts the user to enter the number of students and each student's name and score, and finally displays the student with the highest score and the student with the second-highest score.
- 4.10** (*Find numbers divisible by 5 and 6*) Write a program that displays all the numbers from 100 to 1,000, ten per line, that are divisible by 5 and 6. Numbers are separated by exactly one space.
- 4.11** (*Find numbers divisible by 5 or 6, but not both*) Write a program that displays all the numbers from 100 to 200, ten per line, that are divisible by 5 or 6, but not both. Numbers are separated by exactly one space.
- 4.12** (*Find the smallest n such that $n^2 > 12,000$*) Use a **while** loop to find the smallest integer n such that n^2 is greater than 12,000.
- 4.13** (*Find the largest n such that $n^3 < 12,000$*) Use a **while** loop to find the largest integer n such that n^3 is less than 12,000.

Sections 4.8–4.10

- *4.14** (*Compute the greatest common divisor*) Another solution for Listing 4.9 to find the greatest common divisor of two integers $n1$ and $n2$ is as follows: First find d to be the minimum of $n1$ and $n2$, then check whether d , $d-1$, $d-2$, ..., 2 , or 1 is a divisor for both $n1$ and $n2$ in this order. The first such common divisor is the greatest common divisor for $n1$ and $n2$. Write a program that prompts the user to enter two positive integers and displays the gcd.
- *4.15** (*Display the ASCII character table*) Write a program that prints the characters in the ASCII character table from **!** to **~**. Display ten characters per line. The ASCII table is shown in Appendix B. Characters are separated by exactly one space.
- *4.16** (*Find the factors of an integer*) Write a program that reads an integer and displays all its smallest factors in increasing order. For example, if the input integer is **120**, the output should be as follows: **2, 2, 2, 3, 5**.
- **4.17** (*Display pyramid*) Write a program that prompts the user to enter an integer from **1** to **15** and displays a pyramid, as shown in the following sample run:



```

Enter the number of lines: 7 
      1
     2 1 2
    3 2 1 2 3
   4 3 2 1 2 3 4
  5 4 3 2 1 2 3 4 5
 6 5 4 3 2 1 2 3 4 5 6
7 6 5 4 3 2 1 2 3 4 5 6 7
    
```

***4.18** (Display four patterns using loops) Use nested loops that display the following patterns in four separate programs:

Pattern A	Pattern B	Pattern C	Pattern D
1	1 2 3 4 5 6	1	1 2 3 4 5 6
1 2	1 2 3 4 5	2 1	1 2 3 4 5
1 2 3	1 2 3 4	3 2 1	1 2 3 4
1 2 3 4	1 2 3	4 3 2 1	1 2 3
1 2 3 4 5	1 2	5 4 3 2 1	1 2
1 2 3 4 5 6	1	6 5 4 3 2 1	1

****4.19** (Display numbers in a pyramid pattern) Write a nested **for** loop that prints the following output:

```

      1
     1 2 1
    1 2 4 2 1
   1 2 4 8 4 2 1
  1 2 4 8 16 8 4 2 1
 1 2 4 8 16 32 16 8 4 2 1
1 2 4 8 16 32 64 32 16 8 4 2 1
    
```

***4.20** (Display prime numbers between 2 and 1,000) Modify Listing 4.14 to display all the prime numbers between 2 and 1,000, inclusive. Display eight prime numbers per line. Numbers are separated by exactly one space.

Comprehensive

****4.21** (Financial application: compare loans with various interest rates) Write a program that lets the user enter the loan amount and loan period in number of years and displays the monthly and total payments for each interest rate starting from 5% to 8%, with an increment of 1/8. Here is a sample run:

```

Loan Amount: 10000 
Number of Years: 5 
Interest Rate    Monthly Payment    Total Payment
5.000%          188.71              11322.74
5.125%          189.28              11357.13
5.250%          189.85              11391.59
...
7.875%          202.17              12129.97
8.000%          202.76              12165.83
    
```



For the formula to compute monthly payment, see Listing 2.8, ComputeLoan.java.



VideoNote
Display loan schedule

****4.22** (*Financial application: loan amortization schedule*) The monthly payment for a given loan pays the principal and the interest. The monthly interest is computed by multiplying the monthly interest rate and the balance (the remaining principal). The principal paid for the month is therefore the monthly payment minus the monthly interest. Write a program that lets the user enter the loan amount, number of years, and interest rate and displays the amortization schedule for the loan. Here is a sample run:



```

Loan Amount: 10000  Enter
Number of Years: 1  Enter
Annual Interest Rate: 7  Enter

Monthly Payment: 865.26
Total Payment: 10383.21

Payment#    Interest    Principal    Balance
1           58.33       806.93       9193.07
2           53.62       811.64       8381.43
...
11          10.0        855.26       860.27
12           5.01       860.25       0.01

```

**Note**

The balance after the last payment may not be zero. If so, the last payment should be the normal monthly payment plus the final balance.

Hint: Write a loop to display the table. Since the monthly payment is the same for each month, it should be computed before the loop. The balance is initially the loan amount. For each iteration in the loop, compute the interest and principal, and update the balance. The loop may look like this:

```

for (i = 1; i <= numberOfYears * 12; i++) {
    interest = monthlyInterestRate * balance;
    principal = monthlyPayment - interest;
    balance = balance - principal;
    System.out.println(i + "\t\t" + interest
        + "\t\t" + principal + "\t\t" + balance);
}

```

***4.23** (*Obtain more accurate results*) In computing the following series, you will obtain more accurate results by computing from right to left rather than from left to right:

$$1 + \frac{1}{2} + \frac{1}{3} + \dots + \frac{1}{n}$$

Write a program that computes the results of the summation of the preceding series from left to right and from right to left with $n = 50000$.

***4.24** (*Sum a series*) Write a program to sum the following series:

$$\frac{1}{3} + \frac{3}{5} + \frac{5}{7} + \frac{7}{9} + \frac{9}{11} + \frac{11}{13} + \dots + \frac{95}{97} + \frac{97}{99}$$



VideoNote
Sum a series

****4.25** (Compute π) You can approximate π by using the following series:

$$\pi = 4 \left(1 - \frac{1}{3} + \frac{1}{5} - \frac{1}{7} + \frac{1}{9} - \frac{1}{11} + \dots + \frac{(-1)^{i+1}}{2i-1} \right)$$

Write a program that displays the π value for $i = 10000, 20000, \dots$, and **100000**.

****4.26** (Compute e) You can approximate e using the following series:

$$e = 1 + \frac{1}{1!} + \frac{1}{2!} + \frac{1}{3!} + \frac{1}{4!} + \dots + \frac{1}{i!}$$

Write a program that displays the e value for $i = 10000, 20000, \dots$, and **100000**. (*Hint*: Because $i! = i \times (i-1) \times \dots \times 2 \times 1$, then

$$\frac{1}{i!} \text{ is } \frac{1}{i(i-1)!}$$

Initialize e and $item$ to be **1** and keep adding a new $item$ to e . The new item is the previous item divided by i for $i = 2, 3, 4, \dots$)

****4.27** (Display leap years) Write a program that displays all the leap years, ten per line, in the twenty-first century (from 2001 to 2100), separated by exactly one space.

****4.28** (Display the first days of each month) Write a program that prompts the user to enter the year and first day of the year, and displays the first day of each month in the year on the console. For example, if the user entered the year **2013**, and **2** for Tuesday, January 1, 2013, your program should display the following output:

```
January 1, 2013 is Tuesday
...
December 1, 2013 is Sunday
```

****4.29** (Display calendars) Write a program that prompts the user to enter the year and first day of the year and displays the calendar table for the year on the console. For example, if the user entered the year **2013**, and **2** for Tuesday, January 1, 2013, your program should display the calendar for each month in the year, as follows:

January 2013						
Sun	Mon	Tue	Wed	Thu	Fri	Sat
		1	2	3	4	5
6	7	8	9	10	11	12
13	14	15	16	17	18	19
20	21	22	23	24	25	26
27	28	29	30	31		
:						
:						
December 2013						
Sun	Mon	Tue	Wed	Thu	Fri	Sat
1	2	3	4	5	6	7
8	9	10	11	12	13	14
15	16	17	18	19	20	21
22	23	24	25	26	27	28
29	30	31				

- *4.30** (*Financial application: compound value*) Suppose you save \$100 each month into a savings account with the annual interest rate 5%. So, the monthly interest rate is $0.05 / 12 = 0.00417$. After the first month, the value in the account becomes

$$100 * (1 + 0.00417) = 100.417$$

After the second month, the value in the account becomes

$$(100 + 100.417) * (1 + 0.00417) = 201.252$$

After the third month, the value in the account becomes

$$(100 + 201.252) * (1 + 0.00417) = 302.507$$

and so on.

Write a program that prompts the user to enter an amount (e.g., **100**), the annual interest rate (e.g., **5**), and the number of months (e.g., **6**) and displays the amount in the savings account after the given month.

- *4.31** (*Financial application: compute CD value*) Suppose you put \$10,000 into a CD with an annual percentage yield of 5.75%. After one month, the CD is worth

$$10000 + 10000 * 5.75 / 1200 = 10047.91$$

After two months, the CD is worth

$$10047.91 + 10047.91 * 5.75 / 1200 = 10096.06$$

After three months, the CD is worth

$$10096.06 + 10096.06 * 5.75 / 1200 = 10144.43$$

and so on.

Write a program that prompts the user to enter an amount (e.g., **10000**), the annual percentage yield (e.g., **5.75**), and the number of months (e.g., **18**) and displays a table as shown in the sample run.



```
Enter the initial deposit amount: 10000 ↵Enter
Enter annual percentage yield: 5.75 ↵Enter
Enter maturity period (number of months): 18 ↵Enter
```

```
Month CD Value
1      10047.91
2      10096.06
...
17     10846.56
18     10898.54
```

- **4.32** (*Game: lottery*) Revise Listing 3.9, Lottery.java, to generate a lottery of a two-digit number. The two digits in the number are distinct. (*Hint*: Generate the first digit. Use a loop to continuously generate the second digit until it is different from the first digit.)

- **4.33** (*Perfect number*) A positive integer is called a *perfect number* if it is equal to the sum of all of its positive divisors, excluding itself. For example, 6 is the first perfect number because $6 = 3 + 2 + 1$. The next is $28 = 14 + 7 + 4 + 2 + 1$. There are four perfect numbers less than 10,000. Write a program to find all these four numbers.
- ***4.34** (*Game: scissor, rock, paper*) Exercise 3.17 gives a program that plays the scissor-rock-paper game. Revise the program to let the user continuously play until either the user or the computer wins more than two times.
- *4.35** (*Summation*) Write a program to compute the following summation.
- $$\frac{1}{1 + \sqrt{2}} + \frac{1}{\sqrt{2} + \sqrt{3}} + \frac{1}{\sqrt{3} + \sqrt{4}} + \dots + \frac{1}{\sqrt{624} + \sqrt{625}}$$
- **4.36** (*Business application: checking ISBN*) Use loops to simplify Exercise 3.9.
- **4.37** (*Decimal to binary*) Write a program that prompts the user to enter a decimal integer and displays its corresponding binary value. Don't use Java's `Integer.toString(int)` in this program.
- **4.38** (*Decimal to hex*) Write a program that prompts the user to enter a decimal integer and displays its corresponding hexadecimal value. Don't use Java's `Integer.toHexString(int)` in this program.
- *4.39** (*Financial application: find the sales amount*) You have just started a sales job in a department store. Your pay consists of a base salary and a commission. The base salary is \$5,000. The scheme shown below is used to determine the commission rate.

Sales Amount	Commission Rate
\$0.01–\$5,000	8 percent
\$5,000.01–\$10,000	10 percent
\$10,000.01 and above	12 percent

Your goal is to earn \$30,000 a year. Write a program that finds out the minimum number of sales you have to generate in order to make \$30,000.

- 4.40** (*Simulation: heads or tails*) Write a program that simulates flipping a coin one million times and displays the number of heads and tails.
- **4.41** (*Occurrence of max numbers*) Write a program that reads integers, finds the largest of them, and counts its occurrences. Assume that the input ends with number 0. Suppose that you entered `3 5 2 5 5 5 0`; the program finds that the largest is 5 and the occurrence count for 5 is 4.
- (*Hint:* Maintain two variables, `max` and `count`. `max` stores the current max number, and `count` stores its occurrences. Initially, assign the first number to `max` and 1 to `count`. Compare each subsequent number with `max`. If the number is greater than `max`, assign it to `max` and reset `count` to 1. If the number is equal to `max`, increment `count` by 1.)

```
Enter numbers: 3 5 2 5 5 5 0 →Enter
The largest number is 5
The occurrence count of the largest number is 4
```

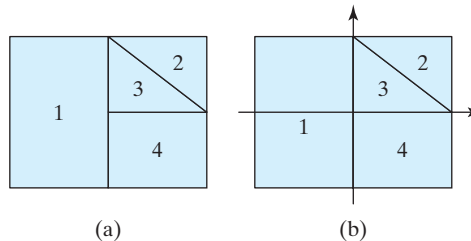


- *4.42** (*Financial application: find the sales amount*) Rewrite Exercise 4.39 as follows:
- Use a **for** loop instead of a **do-while** loop.
 - Let the user enter **COMMISSION_SOUGHT** instead of fixing it as a constant.
- *4.43** (*Simulation: clock countdown*) Write a program that prompts the user to enter the number of seconds, displays a message at every second, and terminates when the time expires. Here is a sample run:



```
Enter the number of seconds: 3 [Enter]
2 seconds remaining
1 second remaining
Stopped
```

- **4.44** (*Monte Carlo simulation*) A square is divided into four smaller regions as shown below in (a). If you throw a dart into the square 1,000,000 times, what is the probability for a dart to fall into an odd-numbered region? Write a program to simulate the process and display the result.
- (*Hint: Place the center of the square in the center of a coordinate system, as shown in (b). Randomly generate a point in the square and count the number of times for a point to fall into an odd-numbered region.*)



- *4.45** (*Math: combinations*) Write a program that displays all possible combinations for picking two numbers from integers **1** to **7**. Also display the total number of all combinations.



```
1 2
1 3
...
...

The total number of all combinations is 21
```

- *4.46** (*Computer architecture: bit-level operations*) A **short** value is stored in **16** bits. Write a program that prompts the user to enter a short integer and displays the **16** bits for the integer. Here are sample runs:



```
Enter an integer: 5 [Enter]
The bits are 0000000000000101
```

```
Enter an integer: -5 
The bits are 1111111111111011
```



(Hint: You need to use the bitwise right shift operator (>>) and the bitwise AND operator (&), which are covered in Appendix G, Bitwise Operations.)

****4.47** (Statistics: compute mean and standard deviation) In business applications, you are often asked to compute the mean and standard deviation of data. The mean is simply the average of the numbers. The standard deviation is a statistic that tells you how tightly all the various data are clustered around the mean in a set of data. For example, what is the average age of the students in a class? How close are the ages? If all the students are the same age, the deviation is 0.

Write a program that prompts the user to enter ten numbers, and displays the mean and standard deviations of these numbers using the following formula:

$$mean = \frac{\sum_{i=1}^n x_i}{n} = \frac{x_1 + x_2 + \dots + x_n}{n} \quad deviation = \sqrt{\frac{\sum_{i=1}^n x_i^2 - \frac{\left(\sum_{i=1}^n x_i\right)^2}{n}}{n - 1}}$$

Here is a sample run:

```
Enter ten numbers: 1 2 3 4.5 5.6 6 7 8 9 10 
The mean is 5.61
The standard deviation is 2.99794
```



This page intentionally left blank

METHODS

Objectives

- To define methods with formal parameters (§5.2).
- To invoke methods with actual parameters (i.e., arguments) (§5.2).
- To define methods with a return value (§5.3).
- To define methods without a return value (§5.4).
- To pass arguments by value (§5.5).
- To develop reusable code that is modular, easy to read, easy to debug, and easy to maintain (§5.6).
- To write a method that converts decimals to hexadecimals (§5.7).
- To use method overloading and understand ambiguous overloading (§5.8).
- To determine the scope of variables (§5.9).
- To solve mathematics problems using the methods in the **Math** class (§§5.10–5.11).
- To apply the concept of method abstraction in software development (§5.12).
- To design and implement methods using stepwise refinement (§5.12).



5.1 Introduction



Methods can be used to define reusable code and organize and simplify code.

problem

Suppose that you need to find the sum of integers from **1** to **10**, from **20** to **37**, and from **35** to **49**, respectively. You may write the code as follows:

```
int sum = 0;
for (int i = 1; i <= 10; i++)
    sum += i;
System.out.println("Sum from 1 to 10 is " + sum);

sum = 0;
for (int i = 20; i <= 37; i++)
    sum += i;
System.out.println("Sum from 20 to 37 is " + sum);

sum = 0;
for (int i = 35; i <= 49; i++)
    sum += i;
System.out.println("Sum from 35 to 49 is " + sum);
```

why methods?

You may have observed that computing these sums from **1** to **10**, from **20** to **37**, and from **35** to **49** are very similar except that the starting and ending integers are different. Wouldn't it be nice if we could write the common code once and reuse it? We can do so by defining a method and invoking it.

The preceding code can be simplified as follows:

define sum method

```
1 public static int sum(int i1, int i2) {
2     int result = 0;
3     for (int i = i1; i <= i2; i++)
4         result += i;
5
6     return result;
7 }
```

main method
invoke sum

```
8
9 public static void main(String[] args) {
10     System.out.println("Sum from 1 to 10 is " + sum(1, 10));
11     System.out.println("Sum from 20 to 37 is " + sum(20, 37));
12     System.out.println("Sum from 35 to 49 is " + sum(35, 49));
13 }
```

method

Lines 1–7 define the method named **sum** with two parameters **i1** and **i2**. The statements in the **main** method invoke **sum(1, 10)** to compute the sum from **1** to **10**, **sum(20, 37)** to compute the sum from **20** to **37**, and **sum(35, 49)** to compute the sum from **35** to **49**.

A *method* is a collection of statements grouped together to perform an operation. In earlier chapters you have used predefined methods such as **System.out.println**, **JOptionPane.showMessageDialog**, **System.exit**, **Math.pow**, and **Math.random**. These methods are defined in the Java library. In this chapter, you will learn how to define your own methods and apply method abstraction to solve complex problems.

5.2 Defining a Method



A method definition consists of its method name, parameters, return value type, and body.

The syntax for defining a method is:

```
modifier returnType methodName(list of parameters) {
    // Method body;
}
```

Let's look at a method defined to find the larger between two integers. This method, named `max`, has two `int` parameters, `num1` and `num2`, the larger of which is returned by the method. Figure 5.1 illustrates the components of this method.

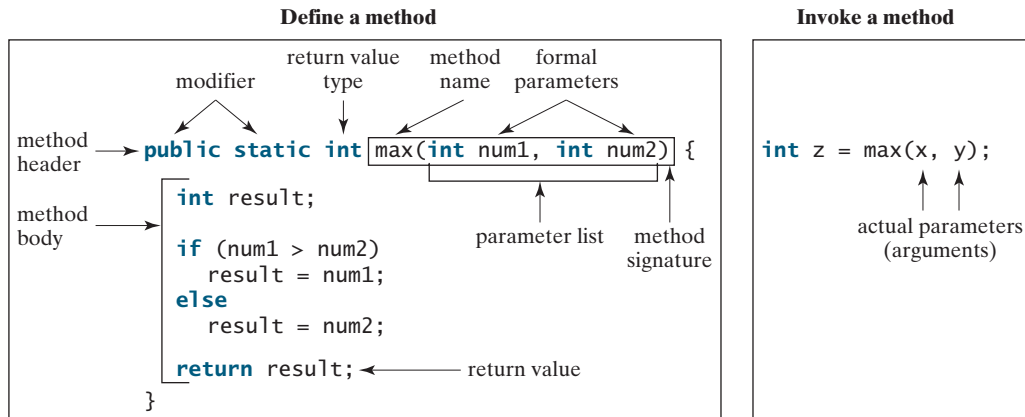


FIGURE 5.1 A method definition consists of a method header and a method body.

The *method header* specifies the *modifiers*, *return value type*, *method name*, and *parameters* of the method. The `static` modifier is used for all the methods in this chapter. The reason for using it will be discussed in Chapter 8, Objects and Classes.

A method may return a value. The *returnValueType* is the data type of the value the method returns. Some methods perform desired operations without returning a value. In this case, the *returnValueType* is the keyword `void`. For example, the *returnValueType* is `void` in the `main` method, as well as in `System.exit`, `System.out.println`, and `JOptionPane.showMessageDialog`. If a method returns a value, it is called a *value-returning method*, otherwise it is called a *void method*.

The variables defined in the method header are known as *formal parameters* or simply *parameters*. A parameter is like a placeholder: When a method is invoked, you pass a value to the parameter. This value is referred to as an *actual parameter* or *argument*. The *parameter list* refers to the method's type, order, and number of the parameters. The method name and the parameter list together constitute the *method signature*. Parameters are optional; that is, a method doesn't have to contain any parameters. For example, the `Math.random()` method has no parameters.

The method body contains a collection of statements that implement the method. The method body of the `max` method uses an `if` statement to determine which number is larger and return the value of that number. In order for a value-returning method to return a result, a return statement using the keyword `return` is *required*. The method terminates when a return statement is executed.



Note

Some programming languages refer to methods as *procedures* and *functions*. In those languages, a value-returning method is called a *function* and a void method is called a *procedure*.



Caution

In the method header, you need to declare each parameter separately. For instance, `max(int num1, int num2)` is correct, but `max(int num1, num2)` is wrong.

method header
modifier

value-returning method
void method
formal parameter
parameter
actual parameter
argument
parameter list
method signature

define vs. declare

**Note**

We say “*define* a method” and “*declare* a variable.” We are making a subtle distinction here. A definition defines what the defined item is, but a declaration usually involves allocating memory to store data for the declared item.

5.3 Calling a Method



Calling a method executes the code in the method.

In a method definition, you define what the method is to do. To execute the method, you have to *call* or *invoke* it. There are two ways to call a method, depending on whether the method returns a value or not.

If a method returns a value, a call to the method is usually treated as a value. For example,

```
int larger = max(3, 4);
```

calls `max(3, 4)` and assigns the result of the method to the variable `larger`. Another example of a call that is treated as a value is

```
System.out.println(max(3, 4));
```

which prints the return value of the method call `max(3, 4)`.

If a method returns `void`, a call to the method must be a statement. For example, the method `println` returns `void`. The following call is a statement:

```
System.out.println("Welcome to Java!");
```

**Note**

A value-returning method can also be invoked as a statement in Java. In this case, the caller simply ignores the return value. This is not often done, but it is permissible if the caller is not interested in the return value.

When a program calls a method, program control is transferred to the called method. A called method returns control to the caller when its return statement is executed or when its method-ending closing brace is reached.

Listing 5.1 shows a complete program that is used to test the `max` method.

**VideoNote**

Define/invoke max method

main method

invoke max

define method

LISTING 5.1 TestMax.java

```

1  public class TestMax {
2      /** Main method */
3      public static void main(String[] args) {
4          int i = 5;
5          int j = 2;
6          int k = max(i, j);
7          System.out.println("The maximum of " + i +
8              " and " + j + " is " + k);
9      }
10
11     /** Return the max of two numbers */
12     public static int max(int num1, int num2) {
13         int result;
14
15         if (num1 > num2)
16             result = num1;
17         else
18             result = num2;
19
20         return result;
21     }
22 }
```




The maximum of 5 and 2 is 5

	line#	i	j	k	num1	num2	result
	4	5					
	5		2				
Invoking max	12				5	2	
	13						undefined
	16						5
	6			5			

This program contains the **main** method and the **max** method. The **main** method is just like any other method except that it is invoked by the JVM to start the program. main method

The **main** method's header is always the same. Like the one in this example, it includes the modifiers **public** and **static**, return value type **void**, method name **main**, and a parameter of the **String[]** type. **String[]** indicates that the parameter is an array of **String**, a subject addressed in Chapter 6.

The statements in **main** may invoke other methods that are defined in the class that contains the **main** method or in other classes. In this example, the **main** method invokes **max(i, j)**, which is defined in the same class with the **main** method.

When the **max** method is invoked (line 6), variable **i**'s value **5** is passed to **num1**, and variable **j**'s value **2** is passed to **num2** in the **max** method. The flow of control transfers to the **max** method, and the **max** method is executed. When the **return** statement in the **max** method is executed, the **max** method returns the control to its caller (in this case the caller is the **main** method). This process is illustrated in Figure 5.2. max method

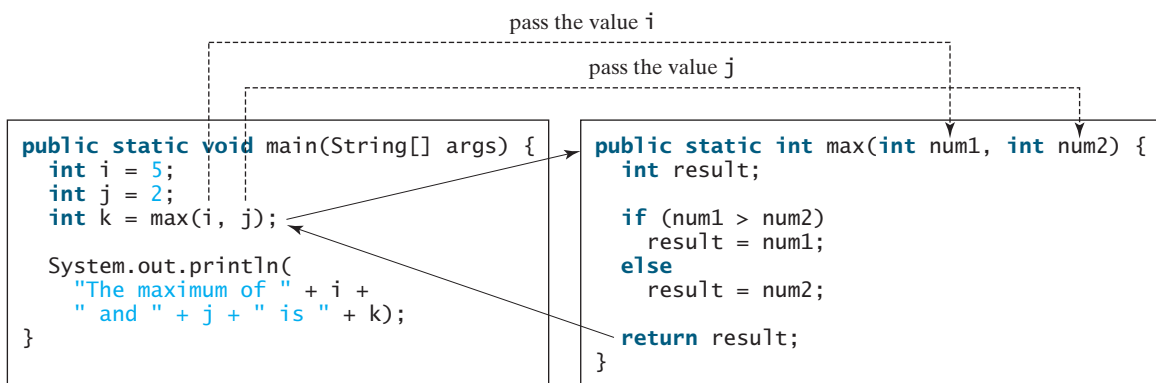
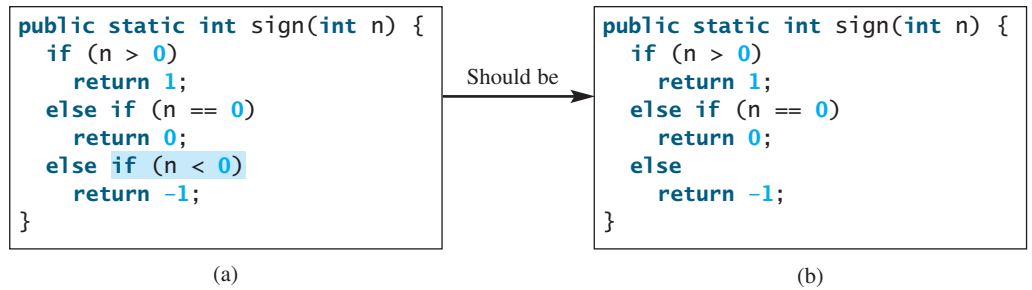


FIGURE 5.2 When the **max** method is invoked, the flow of control transfers to it. Once the **max** method is finished, it returns control back to the caller.



Caution

A **return** statement is required for a value-returning method. The method shown below in (a) is logically correct, but it has a compile error because the Java compiler thinks that this method might not return a value.



To fix this problem, delete `if (n < 0)` in (a), so the compiler will see a `return` statement to be reached regardless of how the `if` statement is evaluated.



Note

Methods enable code sharing and reuse. The `max` method can be invoked from any class, not just `TestMax`. If you create a new class, you can invoke the `max` method using `ClassName.methodName` (i.e., `TestMax.max`).

reusing method

activation record

call stack

Each time a method is invoked, the system creates an *activation record* (also called an *activation frame*) that stores parameters and variables for the method and places the activation record in an area of memory known as a *call stack*. A call stack is also known as an *execution stack*, *runtime stack*, or *machine stack*, and it is often shortened to just “the stack.” When a method calls another method, the caller’s activation record is kept intact, and a new activation record is created for the new method called. When a method finishes its work and returns to its caller, its activation record is removed from the call stack.

A call stack stores the activation records in a last-in, first-out fashion: The activation record for the method that is invoked last is removed first from the stack. For example, suppose method `m1` calls method `m2`, and then `m3`. The runtime system pushes `m1`’s activation record into the stack, then `m2`’s, and then `m3`’s. After `m3` is finished, its activation record is removed from the stack. After `m2` is finished, its activation record is removed from the stack. After `m1` is finished, its activation record is removed from the stack.

Understanding call stacks helps you to comprehend how methods are invoked. The variables defined in the `main` method in Listing 5.1 are `i`, `j`, and `k`. The variables defined in the `max` method are `num1`, `num2`, and `result`. The variables `num1` and `num2` are defined in the method signature and are parameters of the `max` method. Their values are passed through method invocation. Figure 5.3 illustrates the activation records for method calls in the stack.

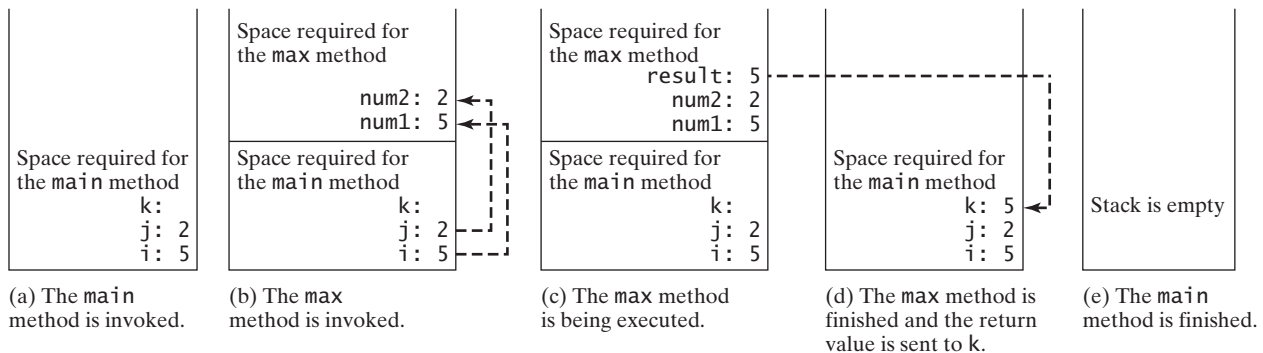


FIGURE 5.3 When the `max` method is invoked, the flow of control transfers to the `max` method. Once the `max` method is finished, it returns control back to the caller.

5.4 void Method Example

A **void** method does not return a value.

The preceding section gives an example of a value-returning method. This section shows how to define and invoke a **void** method. Listing 5.2 gives a program that defines a method named **printGrade** and invokes it to print the grade for a given score.

LISTING 5.2 TestVoidMethod.java

```

1  public class TestVoidMethod {
2      public static void main(String[] args) {
3          System.out.print("The grade is ");
4          printGrade(78.5);
5
6          System.out.print("The grade is ");
7          printGrade(59.5);
8      }
9
10     public static void printGrade(double score) {
11         if (score >= 90.0) {
12             System.out.println('A');
13         }
14         else if (score >= 80.0) {
15             System.out.println('B');
16         }
17         else if (score >= 70.0) {
18             System.out.println('C');
19         }
20         else if (score >= 60.0) {
21             System.out.println('D');
22         }
23         else {
24             System.out.println('F');
25         }
26     }
27 }

```



VideoNote

Use void method

main method

invoke printGrade

printGrade method

```

The grade is C
The grade is F

```



The **printGrade** method is a **void** method because it does not return any value. A call to a **void** method must be a statement. Therefore, it is invoked as a statement in line 4 in the **main** method. Like any Java statement, it is terminated with a semicolon.

To see the differences between a void and value-returning method, let's redesign the **printGrade** method to return a value. The new method, which we call **getGrade**, returns the grade as shown in Listing 5.3.

LISTING 5.3 TestReturnGradeMethod.java

```

1  public class TestReturnGradeMethod {
2      public static void main(String[] args) {
3          System.out.print("The grade is " + getGrade(78.5));
4          System.out.print("\n\nThe grade is " + getGrade(59.5));
5      }
6  }

```

main method

invoke getGrade

invoke void method

void vs. value-returned

getGrade method

```

7  public static char getGrade(double score) {
8      if (score >= 90.0)
9          return 'A';
10     else if (score >= 80.0)
11         return 'B';
12     else if (score >= 70.0)
13         return 'C';
14     else if (score >= 60.0)
15         return 'D';
16     else
17         return 'F';
18 }
19 }
```



```

The grade is C
The grade is F
```

The `getGrade` method defined in lines 7–18 returns a character grade based on the numeric score value. The caller invokes this method in lines 3–4.

The `getGrade` method can be invoked by a caller wherever a character may appear. The `printGrade` method does not return any value, so it must be invoked as a statement.

return in void method



Note

A `return` statement is not needed for a `void` method, but it can be used for terminating the method and returning to the method's caller. The syntax is simply

```
return;
```

This is not often done, but sometimes it is useful for circumventing the normal flow of control in a `void` method. For example, the following code has a `return` statement to terminate the method when the score is invalid.

```

public static void printGrade(double score) {
    if (score < 0 || score > 100) {
        System.out.println("Invalid score");
        return;
    }

    if (score >= 90.0) {
        System.out.println('A');
    }
    else if (score >= 80.0) {
        System.out.println('B');
    }
    else if (score >= 70.0) {
        System.out.println('C');
    }
    else if (score >= 60.0) {
        System.out.println('D');
    }
    else {
        System.out.println('F');
    }
}
```



- 5.1** What are the benefits of using a method?
- 5.2** How do you define a method? How do you invoke a method?
- 5.3** How do you simplify the `max` method in Listing 5.1 using the conditional operator?
- 5.4** True or false? A call to a method with a `void` return type is always a statement itself, but a call to a value-returning method cannot be a statement by itself.
- 5.5** What is the `return` type of a `main` method?
- 5.6** What would be wrong with not writing a `return` statement in a value-returning method? Can you have a `return` statement in a `void` method? Does the `return` statement in the following method cause syntax errors?

```
public static void xMethod(double x, double y) {
    System.out.println(x + y);
    return x + y;
}
```

- 5.7** Define the terms parameter, argument, and method signature.
- 5.8** Write method headers (not the bodies) for the following methods:
- Compute a sales commission, given the sales amount and the commission rate.
 - Display the calendar for a month, given the month and year.
 - Compute a square root of a number.
 - Test whether a number is even, and returning `true` if it is.
 - Display a message a specified number of times.
 - Compute the monthly payment, given the loan amount, number of years, and annual interest rate.
 - Find the corresponding uppercase letter, given a lowercase letter.
- 5.9** Identify and correct the errors in the following program:

```
1 public class Test {
2     public static method1(int n, m) {
3         n += m;
4         method2(3.4);
5     }
6
7     public static int method2(int n) {
8         if (n > 0) return 1;
9         else if (n == 0) return 0;
10        else if (n < 0) return -1;
11    }
12 }
```

- 5.10** Reformat the following program according to the programming style and documentation guidelines proposed in Section 1.10, Programming Style and Documentation. Use the next-line brace style.

```
public class Test {
    public static double method1(double i, double j)
    {
        while (i < j) {
            j--;
        }

        return j;
    }
}
```

5.5 Passing Parameters by Values



The arguments are passed by value to parameters when invoking a method.

parameter order association

The power of a method is its ability to work with parameters. You can use `println` to print any string and `max` to find the maximum of any two `int` values. When calling a method, you need to provide arguments, which must be given in the same order as their respective parameters in the method signature. This is known as *parameter order association*. For example, the following method prints a message `n` times:

```
public static void nPrintln(String message, int n) {
    for (int i = 0; i < n; i++)
        System.out.println(message);
}
```

You can use `nPrintln("Hello", 3)` to print `Hello` three times. The `nPrintln("Hello", 3)` statement passes the actual string parameter `Hello` to the parameter `message`, passes `3` to `n`, and prints `Hello` three times. However, the statement `nPrintln(3, "Hello")` would be wrong. The data type of `3` does not match the data type for the first parameter, `message`, nor does the second argument, `Hello`, match the second parameter, `n`.



Caution

The arguments must match the parameters in *order*, *number*, and *compatible type*, as defined in the method signature. Compatible type means that you can pass an argument to a parameter without explicit casting, such as passing an `int` value argument to a `double` value parameter.

pass-by-value

When you invoke a method with an argument, the value of the argument is passed to the parameter. This is referred to as *pass-by-value*. If the argument is a variable rather than a literal value, the value of the variable is passed to the parameter. The variable is not affected, regardless of the changes made to the parameter inside the method. As shown in Listing 5.4, the value of `x (1)` is passed to the parameter `n` to invoke the `increment` method (line 5). The parameter `n` is incremented by `1` in the method (line 10), but `x` is not changed no matter what the method does.

LISTING 5.4 Increment.java

invoke increment

increment n

```
1 public class Increment {
2     public static void main(String[] args) {
3         int x = 1;
4         System.out.println("Before the call, x is " + x);
5         increment(x);
6         System.out.println("After the call, x is " + x);
7     }
8
9     public static void increment(int n) {
10        n++;
11        System.out.println("n inside the method is " + n);
12    }
13 }
```



```
Before the call, x is 1
n inside the method is 2?
After the call, x is 1
```

Listing 5.5 gives another program that demonstrates the effect of passing by value. The program creates a method for swapping two variables. The `swap` method is invoked by passing two arguments. Interestingly, the values of the arguments are not changed after the method is invoked.

LISTING 5.5 TestPassByValue.java

```

1  public class TestPassByValue {
2      /** Main method */
3      public static void main(String[] args) {
4          // Declare and initialize variables
5          int num1 = 1;
6          int num2 = 2;
7
8          System.out.println("Before invoking the swap method, num1 is " +
9              num1 + " and num2 is " + num2);
10
11         // Invoke the swap method to attempt to swap two variables
12         swap(num1, num2);
13
14         System.out.println("After invoking the swap method, num1 is " +
15             num1 + " and num2 is " + num2);
16     }
17
18     /** Swap two variables */
19     public static void swap(int n1, int n2) {
20         System.out.println("\t\t\tInside the swap method");
21         System.out.println("\t\t\tBefore swapping, n1 is " + n1
22             + " and n2 is " + n2);
23
24         // Swap n1 with n2
25         int temp = n1;
26         n1 = n2;
27         n2 = temp;
28
29         System.out.println("\t\t\tAfter swapping, n1 is " + n1
30             + " and n2 is " + n2);
31     }
32 }

```

false swap



```

Before invoking the swap method, num1 is 1 and num2 is 2
Inside the swap method
  Before swapping, n1 is 1 and n2 is 2
  After swapping, n1 is 2 and n2 is 1
After invoking the swap method, num1 is 1 and num2 is 2

```

Before the `swap` method is invoked (line 12), `num1` is 1 and `num2` is 2. After the `swap` method is invoked, `num1` is still 1 and `num2` is still 2. Their values have not been swapped. As shown in Figure 5.4, the values of the arguments `num1` and `num2` are passed to `n1` and `n2`, but `n1` and `n2` have their own memory locations independent of `num1` and `num2`. Therefore, changes in `n1` and `n2` do not affect the contents of `num1` and `num2`.

Another twist is to change the parameter name `n1` in `swap` to `num1`. What effect does this have? No change occurs, because it makes no difference whether the parameter and the argument have the same name. The parameter is a variable in the method with its own memory space. The variable is allocated when the method is invoked, and it disappears when the method is returned to its caller.

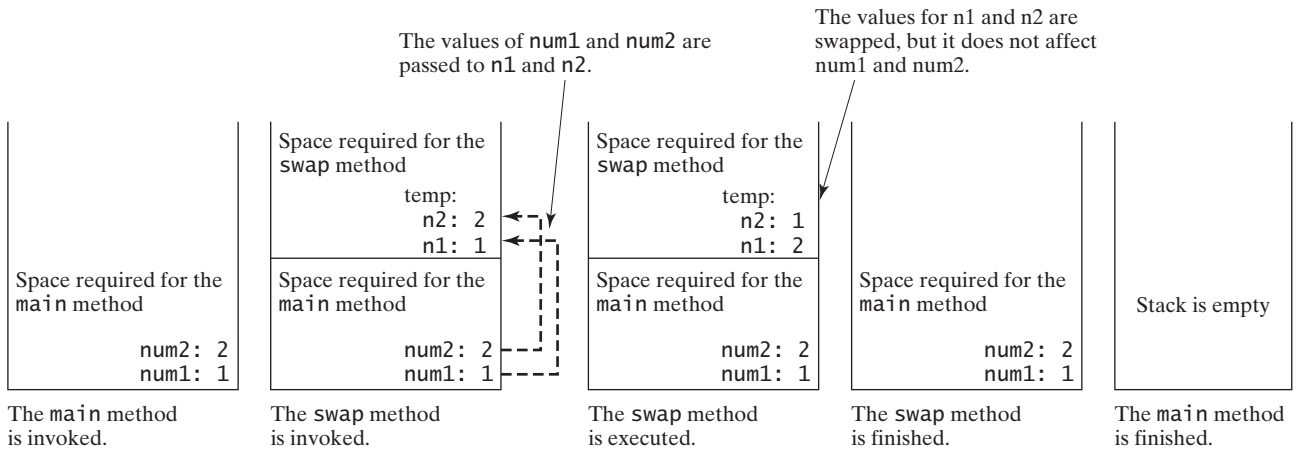


FIGURE 5.4 The values of the variables are passed to the method’s parameters.



Note

For simplicity, Java programmers often say *passing x to y*, which actually means *passing the value of argument x to parameter y*.



MyProgrammingLab™

5.11 How is an argument passed to a method? Can the argument have the same name as its parameter?

5.12 Identify and correct the errors in the following program:

```

1 public class Test {
2     public static void main(String[] args) {
3         nPrintln(5, "Welcome to Java!");
4     }
5
6     public static void nPrintln(String message, int n) {
7         int n = 1;
8         for (int i = 0; i < n; i++)
9             System.out.println(message);
10    }
11 }

```

5.13 What is pass-by-value? Show the result of the following programs.

```

public class Test {
    public static void main(String[] args) {
        int max = 0;
        max(1, 2, max);
        System.out.println(max);
    }

    public static void max(
        int value1, int value2, int max) {
        if (value1 > value2)
            max = value1;
        else
            max = value2;
    }
}

```

(a)

```

public class Test {
    public static void main(String[] args) {
        int i = 1;
        while (i <= 6) {
            method1(i, 2);
            i++;
        }

        public static void method1(
            int i, int num) {
            for (int j = 1; j <= i; j++) {
                System.out.print(num + " ");
                num *= 2;
            }

            System.out.println();
        }
    }
}

```

(b)


```

public class Test {
    public static void main(String[] args) {
        // Initialize times
        int times = 3;
        System.out.println("Before the call,"
            + " variable times is " + times);

        // Invoke nPrintln and display times
        nPrintln("Welcome to Java!", times);
        System.out.println("After the call,"
            + " variable times is " + times);
    }

    // Print the message n times
    public static void nPrintln(
        String message, int n) {
        while (n > 0) {
            System.out.println("n = " + n);
            System.out.println(message);
            n--;
        }
    }
}

```

(c)

```

public class Test {
    public static void main(String[] args) {
        int i = 0;
        while (i <= 4) {
            method1(i);
            i++;
        }

        System.out.println("i is " + i);
    }

    public static void method1(int i) {
        do {
            if (i % 3 != 0)
                System.out.print(i + " ");
            i--;
        }
        while (i >= 1);

        System.out.println();
    }
}

```

(d)

5.14 For (a) in the preceding question, show the contents of the activation records in the call stack just before the method `max` is invoked, just as `max` is entered, just before `max` is returned, and right after `max` is returned.

5.6 Modularizing Code

Modularizing makes the code easy to maintain and debug and enables the code to be reused.

Methods can be used to reduce redundant code and enable code reuse. Methods can also be used to modularize code and improve the quality of the program.

Listing 4.9 gives a program that prompts the user to enter two integers and displays their greatest common divisor. You can rewrite the program using a method, as shown in Listing 5.6.



VideoNote

Modularize code

LISTING 5.6 GreatestCommonDivisorMethod.java

```

1  import java.util.Scanner;
2
3  public class GreatestCommonDivisorMethod {
4      /** Main method */
5      public static void main(String[] args) {
6          // Create a Scanner
7          Scanner input = new Scanner(System.in);
8
9          // Prompt the user to enter two integers
10         System.out.print("Enter first integer: ");
11         int n1 = input.nextInt();
12         System.out.print("Enter second integer: ");
13         int n2 = input.nextInt();
14

```

```

15     System.out.println("The greatest common divisor for " + n1 +
16         " and " + n2 + " is " + gcd(n1, n2));
17 }
18
19 /** Return the gcd of two integers */
20 public static int gcd(int n1, int n2) {
21     int gcd = 1; // Initial gcd is 1
22     int k = 2; // Possible gcd
23
24     while (k <= n1 && k <= n2) {
25         if (n1 % k == 0 && n2 % k == 0)
26             gcd = k; // Update gcd
27         k++;
28     }
29
30     return gcd; // Return gcd
31 }
32 }

```

invoke gcd

compute gcd

return gcd



```

Enter first integer: 45 ↵
Enter second integer: 75 ↵
The greatest common divisor for 45 and 75 is 15

```

By encapsulating the code for obtaining the gcd in a method, this program has several advantages:

1. It isolates the problem for computing the gcd from the rest of the code in the main method. Thus, the logic becomes clear and the program is easier to read.
2. The errors on computing the gcd are confined in the `gcd` method, which narrows the scope of debugging.
3. The `gcd` method now can be reused by other programs.

Listing 5.7 applies the concept of code modularization to improve Listing 4.14, `PrimeNumber.java`.

LISTING 5.7 PrimeNumberMethod.java

```

1 public class PrimeNumberMethod {
2     public static void main(String[] args) {
3         System.out.println("The first 50 prime numbers are \n");
4         printPrimeNumbers(50);
5     }
6
7     public static void printPrimeNumbers(int numberOfPrimes) {
8         final int NUMBER_OF_PRIMES_PER_LINE = 10; // Display 10 per line
9         int count = 0; // Count the number of prime numbers
10        int number = 2; // A number to be tested for primeness
11
12        // Repeatedly find prime numbers
13        while (count < numberOfPrimes) {
14            // Print the prime number and increase the count
15            if (isPrime(number)) {
16                count++; // Increase the count
17

```

invoke printPrimeNumbers

printPrimeNumbers method

invoke isPrime

```

18     if (count % NUMBER_OF_PRIMES_PER_LINE == 0) {
19         // Print the number and advance to the new line
20         System.out.printf("%-5s\n", number);
21     }
22     else
23         System.out.printf("%-5s", number);
24 }
25
26 // Check whether the next number is prime
27 number++;
28 }
29 }
30
31 /** Check whether number is prime */
32 public static boolean isPrime(int number) {
33     for (int divisor = 2; divisor <= number / 2; divisor++) {
34         if (number % divisor == 0) { // If true, number is not prime
35             return false; // Number is not a prime
36         }
37     }
38
39     return true; // Number is prime
40 }
41 }

```

isPrime method

The first 50 prime numbers are

2	3	5	7	11	13	17	19	23	29
31	37	41	43	47	53	59	61	67	71
73	79	83	89	97	101	103	107	109	113
127	131	137	139	149	151	157	163	167	173
179	181	191	193	197	199	211	223	227	229



We divided a large problem into two subproblems: determining whether a number is a prime and printing the prime numbers. As a result, the new program is easier to read and easier to debug. Moreover, the methods `printPrimeNumbers` and `isPrime` can be reused by other programs.

5.7 Case Study: Converting Decimals to Hexadecimals

This section presents a program that converts a decimal number to a hexadecimal number.

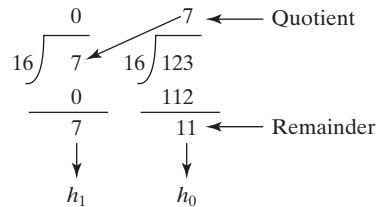


Hexadecimals are often used in computer systems programming (see Appendix F for an introduction to number systems). To convert a decimal number d to a hexadecimal number is to find the hexadecimal digits $h_n, h_{n-1}, h_{n-2}, \dots, h_2, h_1$, and h_0 such that

$$d = h_n \times 16^n + h_{n-1} \times 16^{n-1} + h_{n-2} \times 16^{n-2} + \dots + h_2 \times 16^2 + h_1 \times 16^1 + h_0 \times 16^0$$

These hexadecimal digits can be found by successively dividing d by 16 until the quotient is 0. The remainders are $h_0, h_1, h_2, \dots, h_{n-2}, h_{n-1}$, and h_n . The hexadecimal digits include the decimal digits 0, 1, 2, 3, 4, 5, 6, 7, 8, and 9, plus A, which is the decimal value 10; B, which is the decimal value 11; C, which is 12; D, which is 13; E, which is 14; and F, which is 15.

For example, the decimal number **123** is **7B** in hexadecimal. The conversion is done as follows. Divide **123** by **16**. The remainder is **11** (**B** in hexadecimal) and the quotient is **7**. Continue to divide **7** by **16**. The remainder is **7** and the quotient is **0**. Therefore **7B** is the hexadecimal number for **123**.



Listing 5.8 gives a program that prompts the user to enter a decimal number and converts it into a hex number as a string.

LISTING 5.8 Decimal2HexConversion.java

```

1  import java.util.Scanner;
2
3  public class Decimal2HexConversion {
4      /** Main method */
5      public static void main(String[] args) {
6          // Create a Scanner
7          Scanner input = new Scanner(System.in);
8
9          // Prompt the user to enter a decimal integer
10         System.out.print("Enter a decimal number: ");
11         int decimal = input.nextInt();
12
13         System.out.println("The hex number for decimal " +
14             decimal + " is " + decimalToHex(decimal));
15     }
16
17     /** Convert a decimal to a hex as a string */
18     public static String decimalToHex(int decimal) {
19         String hex = "";
20
21         while (decimal != 0) {
22             int hexValue = decimal % 16;
23             hex = toHexChar(hexValue) + hex;
24             decimal = decimal / 16;
25         }
26
27         return hex;
28     }
29
30     /** Convert an integer to a single hex digit in a character */
31     public static char toHexChar(int hexValue) {
32         if (hexValue <= 9 && hexValue >= 0)
33             return (char)(hexValue + '0');
34         else // hexValue <= 15 && hexValue >= 10
35             return (char)(hexValue - 10 + 'A');
36     }
37 }

```

input decimal

decimal to hex

get a hex char

get a letter



```
Enter a decimal number: 1234 
The hex number for decimal 1234 is 4D2
```

	line#	decimal	hex	hexValue	toHexChar(hexValue)
	19	1234	""		
iteration 1	22			2	
	23		"2"		2
	24	77			
iteration 2	22			13	
	23		"D2"		D
	24	4			
iteration 3	22			4	
	23		"4D2"		4
	24	0			

The program uses the `decimalToHex` method (lines 18–28) to convert a decimal integer to a hex number as a string. The method gets the remainder of the division of the decimal integer by `16` (line 22). The remainder is converted into a character by invoking the `toHexChar` method (line 23). The character is then appended to the hex string (line 23). The hex string is initially empty (line 19). Divide the decimal number by `16` to remove a hex digit from the number (line 24). The `decimalToHex` method repeatedly performs these operations in a loop until quotient becomes `0` (lines 21–25).

The `toHexChar` method (lines 31–36) converts a `hexValue` between `0` and `15` into a hex character. If `hexValue` is between `0` and `9`, it is converted to `(char)(hexValue + '0')` (line 33). Recall that when adding a character with an integer, the character's Unicode is used in the evaluation. For example, if `hexValue` is `5`, `(char)(hexValue + '0')` returns `5`. Similarly, if `hexValue` is between `10` and `15`, it is converted to `(char)(hexValue - 10 + 'A')` (line 35). For instance, if `hexValue` is `11`, `(char)(hexValue - 10 + 'A')` returns `B`.

- 5.15** What is the return value from invoking `toHexChar(5)`? What is the return value from invoking `toHexChar(15)`?
- 5.16** What is the return value from invoking `decimalToHex(245)`? What is the return value from invoking `decimalToHex(3245)`?



MyProgrammingLab™

5.8 Overloading Methods

Overloading methods enables you to define the methods with the same name as long as their signatures are different.



The `max` method that was used earlier works only with the `int` data type. But what if you need to determine which of two floating-point numbers has the maximum value? The solution is to create another method with the same name but different parameters, as shown in the following code:

```
public static double max(double num1, double num2) {
    if (num1 > num2)
        return num1;
    else
        return num2;
}
```

method overloading

If you call `max` with `int` parameters, the `max` method that expects `int` parameters will be invoked; if you call `max` with `double` parameters, the `max` method that expects `double` parameters will be invoked. This is referred to as *method overloading*; that is, two methods have the same name but different parameter lists within one class. The Java compiler determines which method to use based on the method signature.

Listing 5.9 is a program that creates three methods. The first finds the maximum integer, the second finds the maximum double, and the third finds the maximum among three double values. All three methods are named `max`.

LISTING 5.9 TestMethodOverloading.java

```

1  public class TestMethodOverloading {
2      /** Main method */
3      public static void main(String[] args) {
4          // Invoke the max method with int parameters
5          System.out.println("The maximum of 3 and 4 is "
6              + max(3, 4));
7
8          // Invoke the max method with the double parameters
9          System.out.println("The maximum of 3.0 and 5.4 is "
10             + max(3.0, 5.4));
11
12         // Invoke the max method with three double parameters
13         System.out.println("The maximum of 3.0, 5.4, and 10.14 is "
14             + max(3.0, 5.4, 10.14));
15     }
16
17     /** Return the max of two int values */
18     public static int max(int num1, int num2) {
19         if (num1 > num2)
20             return num1;
21         else
22             return num2;
23     }
24
25     /** Find the max of two double values */
26     public static double max(double num1, double num2) {
27         if (num1 > num2)
28             return num1;
29         else
30             return num2;
31     }
32
33     /** Return the max of three double values */
34     public static double max(double num1, double num2, double num3) {
35         return max(max(num1, num2), num3);
36     }
37 }

```

overloaded max

overloaded max

overloaded max



```

The maximum of 3 and 4 is 4
The maximum of 3.0 and 5.4 is 5.4
The maximum of 3.0, 5.4, and 10.14 is 10.14

```

When calling `max(3, 4)` (line 6), the `max` method for finding the maximum of two integers is invoked. When calling `max(3.0, 5.4)` (line 10), the `max` method for finding the maximum of two doubles is invoked. When calling `max(3.0, 5.4, 10.14)` (line 14), the `max` method for finding the maximum of three double values is invoked.

Can you invoke the `max` method with an `int` value and a `double` value, such as `max(2, 2.5)`? If so, which of the `max` methods is invoked? The answer to the first question is yes. The answer to the second question is that the `max` method for finding the maximum of two `double` values is invoked. The argument value `2` is automatically converted into a `double` value and passed to this method.

You may be wondering why the method `max(double, double)` is not invoked for the call `max(3, 4)`. Both `max(double, double)` and `max(int, int)` are possible matches for `max(3, 4)`. The Java compiler finds the most specific method for a method invocation. Since the method `max(int, int)` is more specific than `max(double, double)`, `max(int, int)` is used to invoke `max(3, 4)`.



Tip

Overloading methods can make programs clearer and more readable. Methods that perform the same function with different types of parameters should be given the same name.



Note

Overloaded methods must have different parameter lists. You cannot overload methods based on different modifiers or return types.



Note

Sometimes there are two or more possible matches for an invocation of a method, but the compiler cannot determine the most specific match. This is referred to as *ambiguous invocation*. Ambiguous invocation causes a compile error. Consider the following code:

ambiguous invocation

```
public class AmbiguousOverloading {
    public static void main(String[] args) {
        System.out.println(max(1, 2));
    }

    public static double max(int num1, double num2) {
        if (num1 > num2)
            return num1;
        else
            return num2;
    }

    public static double max(double num1, int num2) {
        if (num1 > num2)
            return num1;
        else
            return num2;
    }
}
```

Both `max(int, double)` and `max(double, int)` are possible candidates to match `max(1, 2)`. Because neither is more specific than the other, the invocation is ambiguous, resulting in a compile error.

- 5.17** What is method overloading? Is it permissible to define two methods that have the same name but different parameter types? Is it permissible to define two methods in a class that have identical method names and parameter lists but different return value types or different modifiers?
- 5.18** What is wrong in the following program?

```
public class Test {
    public static void method(int x) {
    }
}
```



MyProgrammingLab™

```
public static int method(int y) {
    return y;
}
}
```

5.19 Given two method definitions,

```
public static double m(double x, double y)
public static double m(int x, double y)
```

tell which of the two methods is invoked for:

- `double z = m(4, 5);`
- `double z = m(4, 5.4);`
- `double z = m(4.5, 5.4);`

5.9 The Scope of Variables



Key
Point

The scope of a variable is the part of the program where the variable can be referenced.

scope of a variable
local variable

Section 2.5 introduced the scope of a variable. This section discusses the scope of variables in more details. A variable defined inside a method is referred to as a *local variable*. The scope of a local variable starts from its declaration and continues to the end of the block that contains the variable. A local variable must be declared and assigned a value before it can be used.

A parameter is actually a local variable. The scope of a method parameter covers the entire method. A variable declared in the initial-action part of a **for**-loop header has its scope in the entire loop. However, a variable declared inside a **for**-loop body has its scope limited in the loop body from its declaration to the end of the block that contains the variable, as shown in Figure 5.5.

```
public static void method1() {
    .
    .
    for (int i = 1; i < 10; i++) {
        .
        .
        int j;
        .
        .
    }
}
```

FIGURE 5.5 A variable declared in the initial action part of a **for**-loop header has its scope in the entire loop.

You can declare a local variable with the same name in different blocks in a method, but you cannot declare a local variable twice in the same block or in nested blocks, as shown in Figure 5.6.

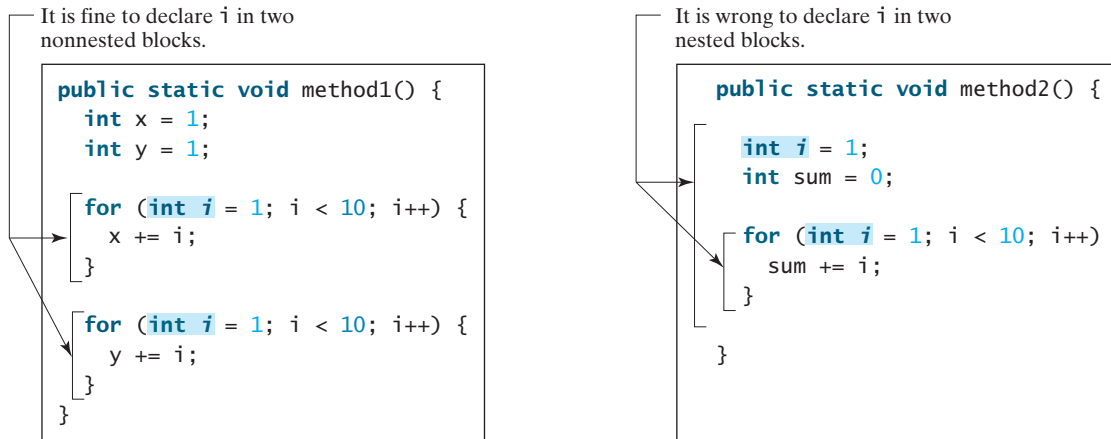


FIGURE 5.6 A variable can be declared multiple times in nonnested blocks, but only once in nested blocks.



Caution

Do not declare a variable inside a block and then attempt to use it outside the block. Here is an example of a common mistake:

```
for (int i = 0; i < 10; i++) {
}
```

```
System.out.println(i);
```

The last statement would cause a syntax error, because variable **i** is not defined outside of the **for** loop.

5.20 What is a local variable?

5.21 What is the scope of a local variable?



MyProgrammingLab™

5.10 The Math Class

The **Math** class contains the methods needed to perform basic mathematical functions.

You have already used the **pow(a, b)** method to compute a^b in Section 2.9.3, Exponent Operations, and the **Math.random()** method in Section 3.8, Generating Random Numbers. This section introduces other useful methods in the **Math** class. They can be categorized as *trigonometric methods*, *exponent methods*, and *service methods*. Service methods include the rounding, min, max, absolute, and random methods. In addition to methods, the **Math** class provides two useful **double** constants, **PI** and **E** (the base of natural logarithms). You can use these constants as **Math.PI** and **Math.E** in any program.



5.10.1 Trigonometric Methods

The **Math** class contains the following trigonometric methods:

```
/** Return the trigonometric sine of an angle in radians */
public static double sin(double radians)

/** Return the trigonometric cosine of an angle in radians */
public static double cos(double radians)

/** Return the trigonometric tangent of an angle in radians */
public static double tan(double radians)
```

```

/** Convert the angle in degrees to an angle in radians */
public static double toRadians(double degree)

/** Convert the angle in radians to an angle in degrees */
public static double toDegrees(double radians)

/** Return the angle in radians for the inverse of sin */
public static double asin(double a)

/** Return the angle in radians for the inverse of cos */
public static double acos(double a)

/** Return the angle in radians for the inverse of tan */
public static double atan(double a)

```

The parameter for `sin`, `cos`, and `tan` is an angle in radians. The return value for `asin`, `acos`, and `atan` is a degree in radians in the range between $-\pi/2$ and $\pi/2$. One degree is equal to $\pi/180$ in radians, 90 degrees is equal to $\pi/2$ in radians, and 30 degrees is equal to $\pi/6$ in radians.

For example,

```

Math.toDegrees(Math.PI / 2) returns 90.0
Math.toRadians(30) returns 0.5236 (same as  $\pi/6$ )
Math.sin(0) returns 0.0
Math.sin(Math.toRadians(270)) returns -1.0
Math.sin(Math.PI / 6) returns 0.5
Math.sin(Math.PI / 2) returns 1.0
Math.cos(0) returns 1.0
Math.cos(Math.PI / 6) returns 0.866
Math.cos(Math.PI / 2) returns 0
Math.asin(0.5) returns 0.523598333 (same as  $\pi/6$ )

```

5.10.2 Exponent Methods

There are five methods related to exponents in the `Math` class:

```

/** Return e raised to the power of x ( $e^x$ ) */
public static double exp(double x)

/** Return the natural logarithm of x ( $\ln(x) = \log_e(x)$ ) */
public static double log(double x)

/** Return the base 10 logarithm of x ( $\log_{10}(x)$ ) */
public static double log10(double x)

/** Return a raised to the power of b ( $a^b$ ) */
public static double pow(double a, double b)

/** Return the square root of x  $\sqrt{x}$  for  $x \geq 0$  */
public static double sqrt(double x)

```

For example,

```

Math.exp(1) returns 2.71828
Math.log(Math.E) returns 1.0
Math.log10(10) returns 1.0
Math.pow(2, 3) returns 8.0
Math.pow(3, 2) returns 9.0
Math.pow(3.5, 2.5) returns 22.91765

```

Math.sqrt(4) returns 2.0
 Math.sqrt(10.5) returns 3.24

5.10.3 The Rounding Methods

The **Math** class contains five rounding methods:

```
/** x is rounded up to its nearest integer. This integer is
 * returned as a double value. */
public static double ceil(double x)

/** x is rounded down to its nearest integer. This integer is
 * returned as a double value. */
public static double floor(double x)

/** x is rounded to its nearest integer. If x is equally close
 * to two integers, the even one is returned as a double. */
public static double rint(double x)

/** Return (int)Math.floor(x + 0.5). */
public static int round(float x)

/** Return (long)Math.floor(x + 0.5). */
public static long round(double x)
```

For example,

```
Math.ceil(2.1) returns 3.0
Math.ceil(2.0) returns 2.0
Math.ceil(-2.0) returns -2.0
Math.ceil(-2.1) returns -2.0
Math.floor(2.1) returns 2.0
Math.floor(2.0) returns 2.0
Math.floor(-2.0) returns -2.0
Math.floor(-2.1) returns -3.0
Math.rint(2.1) returns 2.0
Math.rint(-2.0) returns -2.0
Math.rint(-2.1) returns -2.0
Math.rint(2.5) returns 2.0
Math.rint(3.5) returns 4.0
Math.rint(-2.5) returns -2.0
Math.round(2.6f) returns 3 // Returns int
Math.round(2.0) returns 2 // Returns long
Math.round(-2.0f) returns -2 // Returns int
Math.round(-2.6) returns -3 // Returns long
Math.round(-2.4) returns -2 // Returns long
```

5.10.4 The **min**, **max**, and **abs** Methods

The **min** and **max** methods are overloaded to return the minimum and maximum numbers of two numbers (**int**, **long**, **float**, or **double**). For example, **max(3.4, 5.0)** returns **5.0**, and **min(3, 2)** returns **2**.

The **abs** method is overloaded to return the absolute value of the number (**int**, **long**, **float**, or **double**). For example,

```
Math.max(2, 3) returns 3
Math.max(2.5, 3) returns 3.0
Math.min(2.5, 3.6) returns 2.5
```

`Math.abs(-2)` returns **2**
`Math.abs(-2.1)` returns **2.1**

5.10.5 The `random` Method

You have used the `random()` method to generate a random **double** value greater than or equal to **0.0** and less than **1.0** ($0 \leq \text{Math.random}() < 1.0$). This method is very useful. You can use it to write a simple expression to generate random numbers in any range. For example,

`(int)(Math.random() * 10)` → Returns a random integer between **0** and **9**

`50 + (int)(Math.random() * 50)` → Returns a random integer between **50** and **99**

In general,

`a + Math.random() * b` → Returns a random number between **a** and **a + b**, excluding **a + b**



Tip

You can view the complete documentation for the `Math` class online at download.oracle.com/javase/7/docs/api/, as shown in Figure 5.7.



Note

Not all classes need a `main` method. The `Math` class and the `JOptionPane` class do not have `main` methods. These classes contain methods for other classes to use.

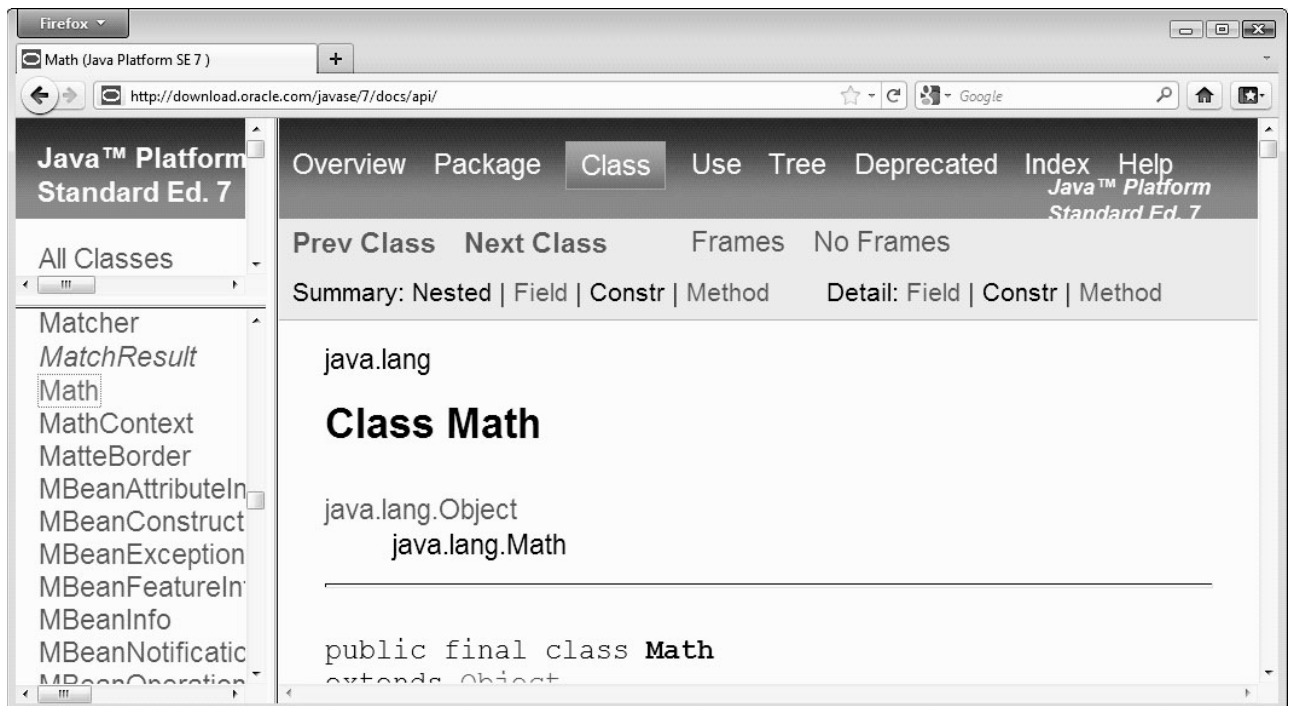


FIGURE 5.7 You can view the documentation for the Java API online.

- 5.22** True or false? The argument for trigonometric methods is an angle in radians.
- 5.23** Write an expression that obtains a random integer between **34** and **55**. Write an expression that obtains a random integer between **0** and **999**. Write an expression that obtains a random number between **5.5** and **55.5**. Write an expression that obtains a random lowercase letter.
- 5.24** Evaluate the following method calls:
- | | |
|---|--|
| a. <code>Math.sqrt(4)</code> | j. <code>Math.floor(-2.5)</code> |
| b. <code>Math.sin(2 * Math.PI)</code> | k. <code>Math.round(-2.5f)</code> |
| c. <code>Math.cos(2 * Math.PI)</code> | l. <code>Math.round(-2.5)</code> |
| d. <code>Math.pow(2, 2)</code> | m. <code>Math rint(2.5)</code> |
| e. <code>Math.log(Math.E)</code> | n. <code>Math.ceil(2.5)</code> |
| f. <code>Math.exp(1)</code> | o. <code>Math.floor(2.5)</code> |
| g. <code>Math.max(2, Math.min(3, 4))</code> | p. <code>Math.round(2.5f)</code> |
| h. <code>Math rint(-2.5)</code> | q. <code>Math.round(2.5)</code> |
| i. <code>Math.ceil(-2.5)</code> | r. <code>Math.round(Math.abs(-2.5))</code> |



5.1.1 Case Study: Generating Random Characters

A character is coded using an integer. Generating a random character is to generate an integer.



Computer programs process numerical data and characters. You have seen many examples that involve numerical data. It is also important to understand characters and how to process them. This section presents an example of generating random characters.

As introduced in Section 2.17, every character has a unique Unicode between **0** and **FFFF** in hexadecimal (**65535** in decimal). To generate a random character is to generate a random integer between **0** and **65535** using the following expression (note that since **0 <= Math.random() < 1.0**, you have to add **1** to **65535**):

```
(int)(Math.random() * (65535 + 1))
```

Now let's consider how to generate a random lowercase letter. The Unicodes for lowercase letters are consecutive integers starting from the Unicode for **a**, then that for **b**, **c**, . . . , and **z**. The Unicode for **a** is

```
(int)'a'
```

Thus, a random integer between `(int)'a'` and `(int)'z'` is

```
(int)((int)'a' + Math.random() * ((int)'z' - (int)'a' + 1))
```

As discussed in Section 2.17.3, all numeric operators can be applied to the **char** operands. The **char** operand is cast into a number if the other operand is a number or a character. Therefore, the preceding expression can be simplified as follows:

```
'a' + Math.random() * ('z' - 'a' + 1)
```

and a random lowercase letter is

```
(char>('a' + Math.random() * ('z' - 'a' + 1)))
```

Hence, a random character between any two characters `ch1` and `ch2` with `ch1 < ch2` can be generated as follows:

```
(char)(ch1 + Math.random() * (ch2 - ch1 + 1))
```

This is a simple but useful discovery. Listing 5.10 creates a class named `RandomCharacter` with five overloaded methods to get a certain type of character randomly. You can use these methods in your future projects.

LISTING 5.10 RandomCharacter.java

```

1  public class RandomCharacter {
2      /** Generate a random character between ch1 and ch2 */
getRandomCharacter 3      public static char getRandomCharacter(char ch1, char ch2) {
4          return (char)(ch1 + Math.random() * (ch2 - ch1 + 1));
5      }
6
getRandomLower 7      /** Generate a random lowercase letter */
CaseLetter() 8      public static char getRandomLowerCaseLetter() {
9          return getRandomCharacter('a', 'z');
10     }
11
getRandomUpper 12     /** Generate a random uppercase letter */
CaseLetter() 13     public static char getRandomUpperCaseLetter() {
14         return getRandomCharacter('A', 'Z');
15     }
16
getRandomDigit 17     /** Generate a random digit character */
Character() 18     public static char getRandomDigitCharacter() {
19         return getRandomCharacter('0', '9');
20     }
21
getRandomCharacter() 22     /** Generate a random character */
23     public static char getRandomCharacter() {
24         return getRandomCharacter('\u0000', '\uFFFF');
25     }
26 }

```

Listing 5.11 gives a test program that displays 175 random lowercase letters.

LISTING 5.11 TestRandomCharacter.java

```

1  public class TestRandomCharacter {
2      /** Main method */
constants 3      public static void main(String[] args) {
4          final int NUMBER_OF_CHARS = 175;
5          final int CHARS_PER_LINE = 25;
6
7          // Print random characters between 'a' and 'z', 25 chars per line
lower-case letter 8          for (int i = 0; i < NUMBER_OF_CHARS; i++) {
9              char ch = RandomCharacter.getRandomLowerCaseLetter();
10             if ((i + 1) % CHARS_PER_LINE == 0)
11                 System.out.println(ch);
12             else
13                 System.out.print(ch);
14         }
15     }
16 }

```



```
gmjsohezfkgtazqgmswfc\rao
pnrunulnwmaztlfjedmpchcif
\alqdgivxkxpbzularmqmbhikr
\bnrjlsopfxahssqhwuuljvbe
xbhdotzhpehbqmuwsfktwso\i
cbuwkzgxpmtzihgatdslvbwbz
bfesok\wbhnooygiigzdxuqni
```

Line 9 invokes `getRandomLowerCaseLetter()` defined in the `RandomCharacter` class. Note that `getRandomLowerCaseLetter()` does not have any parameters, but you still have to use the parentheses when defining and invoking the method.

parentheses required

5.12 Method Abstraction and Stepwise Refinement

The key to developing software is to apply the concept of abstraction.

You will learn many levels of abstraction from this book. *Method abstraction* is achieved by separating the use of a method from its implementation. The client can use a method without knowing how it is implemented. The details of the implementation are encapsulated in the method and hidden from the client who invokes the method. This is also known as *information hiding* or *encapsulation*. If you decide to change the implementation, the client program will not be affected, provided that you do not change the method signature. The implementation of the method is hidden from the client in a “black box,” as shown in Figure 5.8.



VideoNote

Stepwise refinement

method abstraction

information hiding

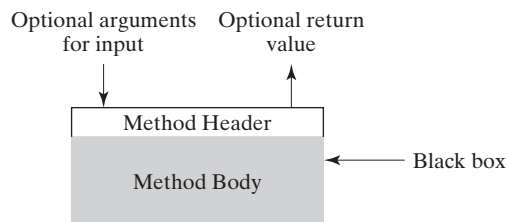


FIGURE 5.8 The method body can be thought of as a black box that contains the detailed implementation for the method.

You have already used the `System.out.print` method to display a string and the `max` method to find the maximum number. You know how to write the code to invoke these methods in your program, but as a user of these methods, you are not required to know how they are implemented.

The concept of method abstraction can be applied to the process of developing programs. When writing a large program, you can use the *divide-and-conquer* strategy, also known as *stepwise refinement*, to decompose it into subproblems. The subproblems can be further decomposed into smaller, more manageable problems.

Suppose you write a program that displays the calendar for a given month of the year. The program prompts the user to enter the year and the month, then displays the entire calendar for the month, as shown in the following sample run.

divide and conquer
stepwise refinement



```

Enter full year (e.g., 2012): 2012 ↵Enter
Enter month as a number between 1 and 12: 3 ↵Enter

      March 2012
-----
Sun Mon Tue Wed Thu Fri Sat
          1  2  3
  4  5  6  7  8  9 10
11 12 13 14 15 16 17
18 19 20 21 22 23 24
25 26 27 28 29 30 31

```

Let us use this example to demonstrate the divide-and-conquer approach.

5.12.1 Top-Down Design

How would you get started on such a program? Would you immediately start coding? Beginning programmers often start by trying to work out the solution to every detail. Although details are important in the final program, concern for detail in the early stages may block the problem-solving process. To make problem solving flow as smoothly as possible, this example begins by using method abstraction to isolate details from design and only later implements the details.

For this example, the problem is first broken into two subproblems: get input from the user, and print the calendar for the month. At this stage, you should be concerned with what the subproblems will achieve, not with how to get input and print the calendar for the month. You can draw a structure chart to help visualize the decomposition of the problem (see Figure 5.9a).

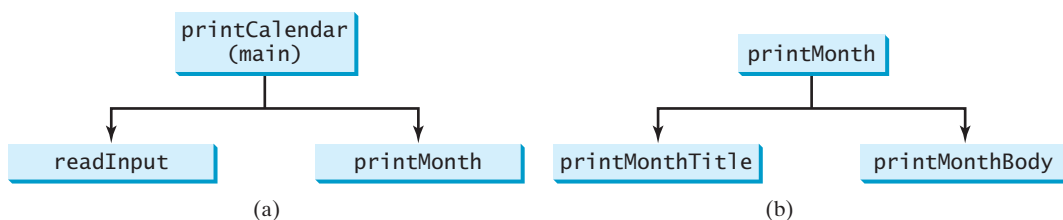


FIGURE 5.9 The structure chart shows that the `printCalendar` problem is divided into two subproblems, `readInput` and `printMonth` in (a), and that `printMonth` is divided into two smaller subproblems, `printMonthTitle` and `printMonthBody` in (b).

You can use `Scanner` to read input for the year and the month. The problem of printing the calendar for a given month can be broken into two subproblems: print the month title, and print the month body, as shown in Figure 5.9b. The month title consists of three lines: month and year, a dashed line, and the names of the seven days of the week. You need to get the month name (e.g., January) from the numeric month (e.g., 1). This is accomplished in `getMonthName` (see Figure 5.10a).

In order to print the month body, you need to know which day of the week is the first day of the month (`getStartDay`) and how many days the month has (`getNumberOfDaysInMonth`),

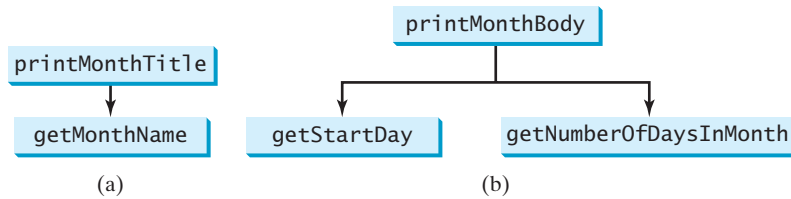


FIGURE 5.10 (a) To `printMonthTitle`, you need `getMonthName`. (b) The `printMonthBody` problem is refined into several smaller problems.

as shown in Figure 5.10b. For example, December 2013 has 31 days, and December 1, 2013, is a Sunday.

How would you get the start day for the first date in a month? There are several ways to do so. For now, we'll use an alternative approach. Assume you know that the start day for January 1, 1800, was a Wednesday (`START_DAY_FOR_JAN_1_1800 = 3`). You could compute the total number of days (`totalNumberOfDays`) between January 1, 1800, and the first date of the calendar month. The start day for the calendar month is $(\text{totalNumberOfDays} + \text{startDay1800}) \% 7$, since every week has seven days. Thus, the `getStartDay` problem can be further refined as `getTotalNumberOfDays`, as shown in Figure 5.11a.

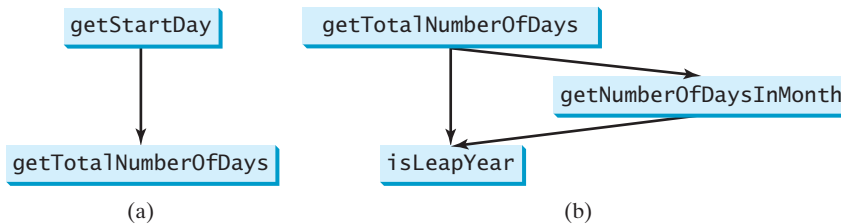


FIGURE 5.11 (a) To `getStartDay`, you need `getTotalNumberOfDays`. (b) The `getTotalNumberOfDays` problem is refined into two smaller problems.

To get the total number of days, you need to know whether the year is a leap year and the number of days in each month. Thus, `getTotalNumberOfDays` can be further refined into two subproblems: `isLeapYear` and `getNumberOfDaysInMonth`, as shown in Figure 5.11b. The complete structure chart is shown in Figure 5.12.

5.12.2 Top-Down and/or Bottom-Up Implementation

Now we turn our attention to implementation. In general, a subproblem corresponds to a method in the implementation, although some are so simple that this is unnecessary. You would need to decide which modules to implement as methods and which to combine in other methods. Decisions of this kind should be based on whether the overall program will be easier to read as a result of your choice. In this example, the subproblem `readInput` can be simply implemented in the `main` method.

You can use either a “top-down” or a “bottom-up” approach. The top-down approach implements one method in the structure chart at a time from the top to the bottom. *Stubs*—a simple but incomplete version of a method—can be used for the methods waiting to be implemented. The use of stubs enables you to quickly build the framework of the program. Implement the `main` method first, then use a stub for the `printMonth` method. For example,

top-down approach
stub

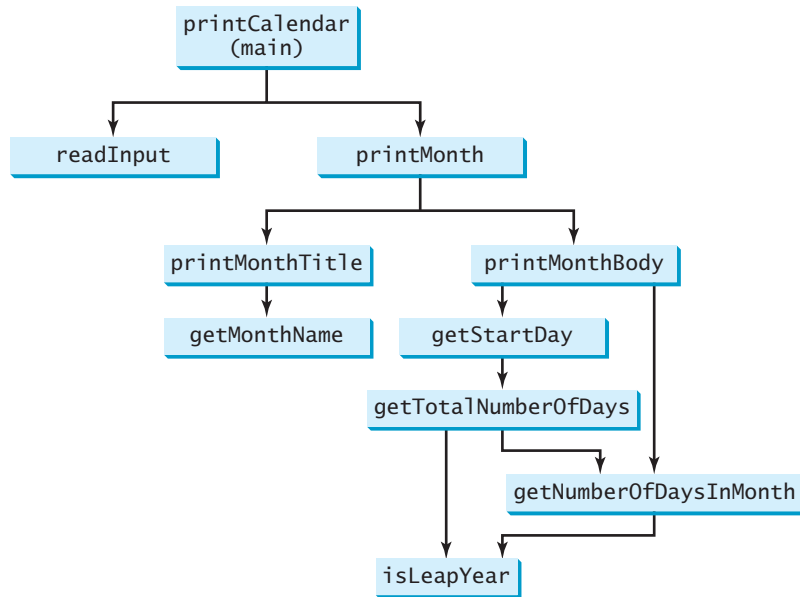


FIGURE 5.12 The structure chart shows the hierarchical relationship of the subproblems in the program.

let `printMonth` display the year and the month in the stub. Thus, your program may begin like this:

```

public class PrintCalendar {
    /** Main method */
    public static void main(String[] args) {
        Scanner input = new Scanner(System.in);

        // Prompt the user to enter year
        System.out.print("Enter full year (e.g., 2012): ");
        int year = input.nextInt();

        // Prompt the user to enter month
        System.out.print("Enter month as a number between 1 and 12: ");
        int month = input.nextInt();

        // Print calendar for the month of the year
        printMonth(year, month);
    }

    /** A stub for printMonth may look like this */
    public static void printMonth(int year, int month) {
        System.out.print(month + " " + year);
    }

    /** A stub for printMonthTitle may look like this */
    public static void printMonthTitle(int year, int month) {
    }

    /** A stub for getMonthBody may look like this */
    public static void printMonthBody(int year, int month) {
    }
}

```

```

/** A stub for getMonthName may look like this */
public static String getMonthName(int month) {
    return "January"; // A dummy value
}

/** A stub for getStartDay may look like this */
public static int getStartDay(int year, int month) {
    return 1; // A dummy value
}

/** A stub for getTotalNumberOfDays may look like this */
public static int getTotalNumberOfDays(int year, int month) {
    return 10000; // A dummy value
}

/** A stub for getNumberOfDaysInMonth may look like this */
public static int getNumberOfDaysInMonth(int year, int month) {
    return 31; // A dummy value
}

/** A stub for isLeapYear may look like this */
public static Boolean isLeapYear(int year) {
    return true; // A dummy value
}
}

```

Compile and test the program, and fix any errors. You can now implement the `printMonth` method. For methods invoked from the `printMonth` method, you can again use stubs.

The bottom-up approach implements one method in the structure chart at a time from the bottom to the top. For each method implemented, write a test program, known as the *driver*, to test it. The top-down and bottom-up approaches are equally good: Both approaches implement methods incrementally, help to isolate programming errors, and make debugging easy. They can be used together.

bottom-up approach
driver

5.12.3 Implementation Details

The `isLeapYear(int year)` method can be implemented using the following code from Section 3.12:

```
return (year % 400 == 0 || (year % 4 == 0 && year % 100 != 0));
```

Use the following facts to implement `getTotalNumberOfDaysInMonth(int year, int month)`:

- January, March, May, July, August, October, and December have 31 days.
- April, June, September, and November have 30 days.
- February has 28 days during a regular year and 29 days during a leap year. A regular year, therefore, has 365 days, a leap year 366 days.

To implement `getTotalNumberOfDays(int year, int month)`, you need to compute the total number of days (`totalNumberOfDays`) between January 1, 1800, and the first day of the calendar month. You could find the total number of days between the year 1800 and the calendar year and then figure out the total number of days prior to the calendar month in the calendar year. The sum of these two totals is `totalNumberOfDays`.

To print a body, first pad some space before the start day and then print the lines for every week.

The complete program is given in Listing 5.12.

LISTING 5.12 PrintCalendar.java

```

1  import java.util.Scanner;
2
3  public class PrintCalendar {
4      /** Main method */
5      public static void main(String[] args) {
6          Scanner input = new Scanner(System.in);
7
8          // Prompt the user to enter year
9          System.out.print("Enter full year (e.g., 2012): ");
10         int year = input.nextInt();
11
12         // Prompt the user to enter month
13         System.out.print("Enter month as a number between 1 and 12: ");
14         int month = input.nextInt();
15
16         // Print calendar for the month of the year
17         printMonth(year, month);
18     }
19
20     /** Print the calendar for a month in a year */
21     public static void printMonth(int year, int month) {
22         // Print the headings of the calendar
23         printMonthTitle(year, month);
24
25         // Print the body of the calendar
26         printMonthBody(year, month);
27     }
28
29     /** Print the month title, e.g., March 2012 */
30     public static void printMonthTitle(int year, int month) {
31         System.out.println("          " + getMonthName(month)
32             + " " + year);
33         System.out.println("-----");
34         System.out.println(" Sun Mon Tue Wed Thu Fri Sat");
35     }
36
37     /** Get the English name for the month */
38     public static String getMonthName(int month) {
39         String monthName = "";
40         switch (month) {
41             case 1: monthName = "January"; break;
42             case 2: monthName = "February"; break;
43             case 3: monthName = "March"; break;
44             case 4: monthName = "April"; break;
45             case 5: monthName = "May"; break;
46             case 6: monthName = "June"; break;
47             case 7: monthName = "July"; break;
48             case 8: monthName = "August"; break;
49             case 9: monthName = "September"; break;
50             case 10: monthName = "October"; break;
51             case 11: monthName = "November"; break;
52             case 12: monthName = "December";
53         }
54
55         return monthName;
56     }
57
58     /** Print month body */

```

```

59 public static void printMonthBody(int year, int month) {           printMonthBody
60 // Get start day of the week for the first date in the month
61 int startDay = getStartDay(year, month);
62
63 // Get number of days in the month
64 int numberOfDaysInMonth = getNumberOfDaysInMonth(year, month);
65
66 // Pad space before the first day of the month
67 int i = 0;
68 for (i = 0; i < startDay; i++)
69     System.out.print("  ");
70
71 for (i = 1; i <= numberOfDaysInMonth; i++) {
72     System.out.printf("%4d", i);
73
74     if ((i + startDay) % 7 == 0)
75         System.out.println();
76 }
77
78 System.out.println();
79 }
80
81 /** Get the start day of month/1/year */
82 public static int getStartDay(int year, int month) {           getStartDay
83     final int START_DAY_FOR_JAN_1_1800 = 3;
84     // Get total number of days from 1/1/1800 to month/1/year
85     int totalNumberOfDays = getTotalNumberOfDays(year, month);
86
87     // Return the start day for month/1/year
88     return (totalNumberOfDays + START_DAY_FOR_JAN_1_1800) % 7;
89 }
90
91 /** Get the total number of days since January 1, 1800 */
92 public static int getTotalNumberOfDays(int year, int month) {   getTotalNumberOfDays
93     int total = 0;
94
95     // Get the total days from 1800 to 1/1/year
96     for (int i = 1800; i < year; i++)
97         if (isLeapYear(i))
98             total = total + 366;
99         else
100            total = total + 365;
101
102     // Add days from Jan to the month prior to the calendar month
103     for (int i = 1; i < month; i++)
104         total = total + getNumberOfDaysInMonth(year, i);
105
106     return total;
107 }
108
109 /** Get the number of days in a month */
110 public static int getNumberOfDaysInMonth(int year, int month) {   getNumberOfDaysInMonth
111     if (month == 1 || month == 3 || month == 5 || month == 7 ||
112         month == 8 || month == 10 || month == 12)
113         return 31;
114
115     if (month == 4 || month == 6 || month == 9 || month == 11)
116         return 30;
117
118     if (month == 2) return isLeapYear(year) ? 29 : 28;

```

```

119
120     return 0; // If month is incorrect
121 }
122
123 /** Determine if it is a leap year */
isLeapYear public static boolean isLeapYear(int year) {
124     return year % 400 == 0 || (year % 4 == 0 && year % 100 != 0);
125 }
126 }
127 }

```

The program does not validate user input. For instance, if the user enters either a month not in the range between **1** and **12** or a year before **1800**, the program displays an erroneous calendar. To avoid this error, add an **if** statement to check the input before printing the calendar.

This program prints calendars for a month but could easily be modified to print calendars for a whole year. Although it can print months only after January **1800**, it could be modified to print months before **1800**.

5.12.4 Benefits of Stepwise Refinement

Stepwise refinement breaks a large problem into smaller manageable subproblems. Each subproblem can be implemented using a method. This approach makes the program easier to write, reuse, debug, test, modify, and maintain.

Simpler Program

The print calendar program is long. Rather than writing a long sequence of statements in one method, stepwise refinement breaks it into smaller methods. This simplifies the program and makes the whole program easier to read and understand.

Reusing Methods

Stepwise refinement promotes code reuse within a program. The **isLeapYear** method is defined once and invoked from the **getTotalNumberOfDays** and **getNumberOfDayInMonth** methods. This reduces redundant code.

Easier Developing, Debugging, and Testing

Since each subproblem is solved in a method, a method can be developed, debugged, and tested individually. This isolates the errors and makes developing, debugging, and testing easier.

When implementing a large program, use the top-down and/or bottom-up approach. Do not write the entire program at once. Using these approaches seems to take more development time (because you repeatedly compile and run the program), but it actually saves time and makes debugging easier.

Better Facilitating Teamwork

When a large problem is divided into subprograms, subproblems can be assigned to different programmers. This makes it easier for programmers to work in teams.

KEY TERMS

actual parameter	179	method overloading	194
ambiguous invocation	195	method signature	179
argument	179	modifier	179
divide and conquer	203	parameter	179
formal parameter (i.e., parameter)	179	pass-by-value	186
information hiding	203	scope of a variable	196
method	178	stepwise refinement	203
method abstraction	203	stub	205

CHAPTER SUMMARY

1. Making programs modular and reusable is one of the central goals in software engineering. Java provides many powerful constructs that help to achieve this goal. *Methods* are one such construct.
2. The method header specifies the *modifiers*, *return value type*, *method name*, and *parameters* of the method. The **static** modifier is used for all the methods in this chapter.
3. A method may return a value. The **returnValueType** is the data type of the value the method returns. If the method does not return a value, the **returnValueType** is the keyword **void**.
4. The *parameter list* refers to the type, order, and number of a method's parameters. The method name and the parameter list together constitute the *method signature*. Parameters are optional; that is, a method doesn't need to contain any parameters.
5. A return statement can also be used in a **void** method for terminating the method and returning to the method's caller. This is useful occasionally for circumventing the normal flow of control in a method.
6. The arguments that are passed to a method should have the same number, type, and order as the parameters in the method signature.
7. When a program calls a method, program control is transferred to the called method. A called method returns control to the caller when its return statement is executed or when its method-ending closing brace is reached.
8. A value-returning method can also be invoked as a statement in Java. In this case, the caller simply ignores the return value.
9. A method can be overloaded. This means that two methods can have the same name, as long as their method parameter lists differ.
10. A variable declared in a method is called a local variable. The *scope of a local variable* starts from its declaration and continues to the end of the block that contains the variable. A local variable must be declared and initialized before it is used.
11. *Method abstraction* is achieved by separating the use of a method from its implementation. The client can use a method without knowing how it is implemented. The details of the implementation are encapsulated in the method and hidden from the client who invokes the method. This is known as *information hiding* or *encapsulation*.
12. Method abstraction modularizes programs in a neat, hierarchical manner. Programs written as collections of concise methods are easier to write, debug, maintain, and modify than would otherwise be the case. This writing style also promotes method reusability.
13. When implementing a large program, use the top-down and/or bottom-up coding approach. Do not write the entire program at once. This approach may seem to take more time for coding (because you are repeatedly compiling and running the program), but it actually saves time and makes debugging easier.

TEST QUESTIONS

Do the test questions for this chapter online at www.cs.armstrong.edu/liang/intro9e/test.html.

Sections 5.2–5.9

- 5.1** (*Math: pentagonal numbers*) A pentagonal number is defined as $n(3n-1)/2$ for $n = 1, 2, \dots$, and so on. Therefore, the first few numbers are 1, 5, 12, 22, . . . Write a method with the following header that returns a pentagonal number:

```
public static int getPentagonalNumber(int n)
```

Write a test program that uses this method to display the first 100 pentagonal numbers with 10 numbers on each line.

- *5.2** (*Sum the digits in an integer*) Write a method that computes the sum of the digits in an integer. Use the following method header:

```
public static int sumDigits(long n)
```

For example, `sumDigits(234)` returns 9 (2 + 3 + 4). (*Hint:* Use the `%` operator to extract digits, and the `/` operator to remove the extracted digit. For instance, to extract 4 from 234, use `234 % 10` (= 4). To remove 4 from 234, use `234 / 10` (= 23). Use a loop to repeatedly extract and remove the digit until all the digits are extracted. Write a test program that prompts the user to enter an integer and displays the sum of all its digits.

- **5.3** (*Palindrome integer*) Write the methods with the following headers

```
// Return the reversal of an integer, i.e., reverse(456) returns 654
public static int reverse(int number)
```

```
// Return true if number is a palindrome
public static boolean isPalindrome(int number)
```

Use the `reverse` method to implement `isPalindrome`. A number is a palindrome if its reversal is the same as itself. Write a test program that prompts the user to enter an integer and reports whether the integer is a palindrome.

- *5.4** (*Display an integer reversed*) Write a method with the following header to display an integer in reverse order:

```
public static void reverse(int number)
```

For example, `reverse(3456)` displays 6543. Write a test program that prompts the user to enter an integer and displays its reversal.

- *5.5** (*Sort three numbers*) Write a method with the following header to display three numbers in increasing order:

```
public static void displaySortedNumbers(
    double num1, double num2, double num3)
```

Write a test program that prompts the user to enter three numbers and invokes the method to display them in increasing order.

- *5.6** (*Display patterns*) Write a method to display a pattern as follows:

```

          1
         2 1
        3 2 1
        ...
n n-1 ... 3 2 1
```



VideoNote

Reverse an integer

The method header is

```
public static void displayPattern(int n)
```

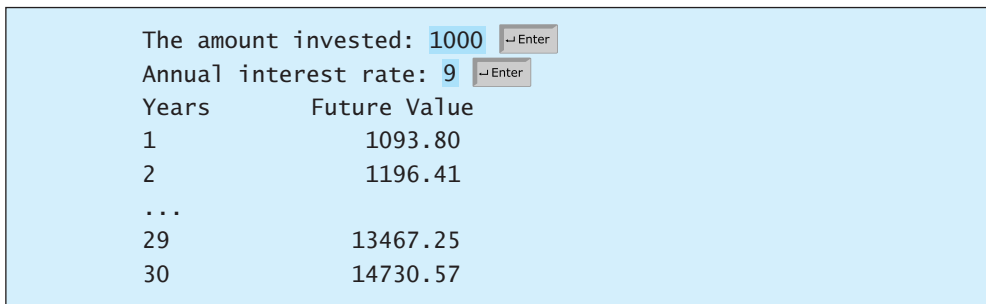
- *5.7** (*Financial application: compute the future investment value*) Write a method that computes future investment value at a given interest rate for a specified number of years. The future investment is determined using the formula in Programming Exercise 2.21.

Use the following method header:

```
public static double futureInvestmentValue(  
    double investmentAmount, double monthlyInterestRate, int years)
```

For example, `futureInvestmentValue(10000, 0.05/12, 5)` returns **12833.59**.

Write a test program that prompts the user to enter the investment amount (e.g., 1000) and the interest rate (e.g., 9%) and prints a table that displays future value for the years from 1 to 30, as shown below:



The screenshot shows a Java application window with a light blue background. It displays a text-based interface where the user has entered '1000' for the investment amount and '9' for the annual interest rate. Below the input fields, a table is printed showing the future value of the investment for each year from 1 to 30. The values increase over time, starting at 1093.80 for year 1 and reaching 14730.57 for year 30. There are three small 'Enter' buttons next to the input fields.

```
The amount invested: 1000 ↵ Enter
Annual interest rate: 9 ↵ Enter
Years      Future Value
1          1093.80
2          1196.41
...
29         13467.25
30         14730.57
```



- 5.8** (*Conversions between Celsius and Fahrenheit*) Write a class that contains the following two methods:

```
/** Convert from Celsius to Fahrenheit */  
public static double celsiusToFahrenheit(double celsius)  
  
/** Convert from Fahrenheit to Celsius */  
public static double fahrenheitToCelsius(double fahrenheit)
```

The formula for the conversion is:

$$\text{fahrenheit} = (9.0 / 5) * \text{celsius} + 32$$

$$\text{celsius} = (5.0 / 9) * (\text{fahrenheit} - 32)$$

Write a test program that invokes these methods to display the following tables:

Celsius	Fahrenheit	Fahrenheit	Celsius
40.0	104.0	120.0	48.89
39.0	102.2	110.0	43.33
...			
32.0	89.6	40.0	4.44
31.0	87.8	30.0	-1.11

- 5.9** (*Conversions between feet and meters*) Write a class that contains the following two methods:

```
/** Convert from feet to meters */  
public static double footToMeter(double foot)
```

```
/** Convert from meters to feet */
public static double meterToFoot(double meter)
```

The formula for the conversion is:

```
meter = 0.305 * foot
foot = 3.279 * meter
```

Write a test program that invokes these methods to display the following tables:

Feet	Meters	Meters	Feet
1.0	0.305	20.0	65.574
2.0	0.610	25.0	81.967
...			
9.0	2.745	60.0	196.721
10.0	3.050	65.0	213.115

5.10 (Use the `isPrime` Method) Listing 5.7, `PrimeNumberMethod.java`, provides the `isPrime(int number)` method for testing whether a number is prime. Use this method to find the number of prime numbers less than **10000**.

5.11 (Financial application: compute commissions) Write a method that computes the commission, using the scheme in Programming Exercise 4.39. The header of the method is as follows:

```
public static double computeCommission(double salesAmount)
```

Write a test program that displays the following table:

Sales Amount	Commission
10000	900.0
15000	1500.0
...	
95000	11100.0
100000	11700.0

5.12 (Display characters) Write a method that prints characters using the following header:

```
public static void printChars(char ch1, char ch2, int
    numberPerLine)
```

This method prints the characters between `ch1` and `ch2` with the specified numbers per line. Write a test program that prints ten characters per line from **1** to **Z**. Characters are separated by exactly one space.

***5.13** (Sum series) Write a method to compute the following series:

$$m(i) = \frac{1}{2} + \frac{2}{3} + \dots + \frac{i}{i+1}$$

Write a test program that displays the following table:

i	m(i)
1	0.5000
2	1.1667
...	
19	16.4023
20	17.3546

VideoNote
Estimate π

***5.14** (Estimate π) π can be computed using the following series:

$$m(i) = 4 \left(1 - \frac{1}{3} + \frac{1}{5} - \frac{1}{7} + \frac{1}{9} - \frac{1}{11} + \dots + \frac{(-1)^{i+1}}{2i-1} \right)$$

Write a method that returns **m(i)** for a given **i** and write a test program that displays the following table:

i	m(i)
1	4.0000
101	3.1515
201	3.1466
301	3.1449
401	3.1441
501	3.1436
601	3.1433
701	3.1430
801	3.1428
901	3.1427

***5.15** (Financial application: print a tax table) Listing 3.6 gives a program to compute tax. Write a method for computing tax using the following header:

```
public static double computetax(int status, double taxableIncome)
```

Use this method to write a program that prints a tax table for taxable income from \$50,000 to \$60,000 with intervals of \$50 for all the following statuses:

Taxable Income	Single	Married Joint or Qualifying Widow(er)	Married Separate	Head of a House
50000	8688	6665	8688	7352
50050	8700	6673	8700	7365
...				
59950	11175	8158	11175	9840
60000	11188	8165	11188	9852

***5.16** (Number of days in a year) Write a method that returns the number of days in a year using the following header:

```
public static int numberOfDaysInAYear(int year)
```

Write a test program that displays the number of days in year from 2000 to 2020.

Sections 5.10–5.11

***5.17** (Display matrix of 0s and 1s) Write a method that displays an n -by- n matrix using the following header:

```
public static void printMatrix(int n)
```

Each element is 0 or 1, which is generated randomly. Write a test program that prompts the user to enter **n** and displays an n -by- n matrix. Here is a sample run:

```
Enter n: 3 
0 1 0
0 0 0
1 1 1
```



- 5.18** (Use the `Math.sqrt` method) Write a program that prints the following table using the `sqrt` method in the `Math` class.

Number	SquareRoot
0	0.0000
2	1.4142
...	
18	4.2426
20	4.4721

- *5.19** (The `MyTriangle` class) Create a class named `MyTriangle` that contains the following two methods:

```
/** Return true if the sum of any two sides is
 * greater than the third side. */
public static boolean isValid(
    double side1, double side2, double side3)

/** Return the area of the triangle. */
public static double area(
    double side1, double side2, double side3)
```

Write a test program that reads three sides for a triangle and computes the area if the input is valid. Otherwise, it displays that the input is invalid. The formula for computing the area of a triangle is given in Programming Exercise 2.15.

- 5.20** (Use trigonometric methods) Print the following table to display the `sin` value and `cos` value of degrees from 0 to 360 with increments of 10 degrees. Round the value to keep four digits after the decimal point.

Degree	Sin	Cos
0	0.0000	1.0000
10	0.1736	0.9848
...		
350	-0.1736	0.9848
360	0.0000	1.0000

- *5.21** (Geometry: great circle distance) The great circle distance is the distance between two points on the surface of a sphere. Let (x_1, y_1) and (x_2, y_2) be the geographical latitude and longitude of two points. The great circle distance between the two points can be computed using the following formula:

$$d = \text{radius} \times \arccos(\sin(x_1) \times \sin(x_2) + \cos(x_1) \times \cos(x_2) \times \cos(y_1 - y_2))$$

Write a program that prompts the user to enter the latitude and longitude of two points on the earth in degrees and displays its great circle distance. The average earth radius is 6,371.01 km. Note that you need to convert the degrees into radians using the `Math.toRadians` method since the Java trigonometric methods use radians. The latitude and longitude degrees in the formula are for North and West. Use negative to indicate South and East degrees. Here is a sample run:



```
Enter point 1 (latitude and longitude) in degrees:
39.55 -116.25 ↵Enter
Enter point 2 (latitude and longitude) in degrees:
41.5 87.37 ↵Enter
The distance between the two points is 10691.79183231593 km
```

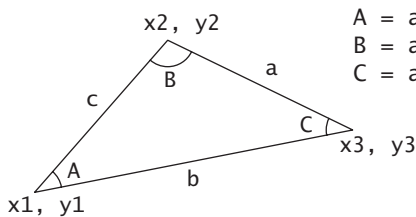
- **5.22** (Math: approximate the square root) There are several techniques for implementing the `sqrt` method in the `Math` class. One such technique is known as the *Babylonian method*. It approximates the square root of a number, `n`, by repeatedly performing a calculation using the following formula:

$$\text{nextGuess} = (\text{lastGuess} + n / \text{lastGuess}) / 2$$

When `nextGuess` and `lastGuess` are almost identical, `nextGuess` is the approximated square root. The initial guess can be any positive value (e.g., `1`). This value will be the starting value for `lastGuess`. If the difference between `nextGuess` and `lastGuess` is less than a very small number, such as `0.0001`, you can claim that `nextGuess` is the approximated square root of `n`. If not, `nextGuess` becomes `lastGuess` and the approximation process continues. Implement the following method that returns the square root of `n`.

```
public static double sqrt(long n)
```

- *5.23** (Geometry: display angles) Write a program that prompts the user to enter three points of a triangle and displays the angles in degrees. Round the value to keep two digits after the decimal point. The formula to compute angles A, B, and C are as follows:



$$A = \arccos((a * a - b * b - c * c) / (-2 * b * c))$$

$$B = \arccos((b * b - a * a - c * c) / (-2 * a * c))$$

$$C = \arccos((c * c - b * b - a * a) / (-2 * a * b))$$

Here is a sample run of the program:

```
Enter three points: 1 1 6.5 1 6.5 2.5 
The three angles are 15.26 90.0 74.74
```



Sections 5.10–5.12

- **5.24** (Display current date and time) Listing 2.6, `ShowCurrentTime.java`, displays the current time. Improve this example to display the current date and time. The calendar example in Listing 5.12, `PrintCalendar.java`, should give you some ideas on how to find the year, month, and day.
- **5.25** (Convert milliseconds to hours, minutes, and seconds) Write a method that converts milliseconds to hours, minutes, and seconds using the following header:

```
public static String convertMillis(long millis)
```

The method returns a string as `hours:minutes:seconds`. For example, `convertMillis(5500)` returns a string `0:0:5`, `convertMillis(100000)` returns a string `0:1:40`, and `convertMillis(555550000)` returns a string `154:19:10`.

Comprehensive

- **5.26** (*Palindromic prime*) A *palindromic prime* is a prime number and also palindromic. For example, 131 is a prime and also a palindromic prime, as are 313 and 757. Write a program that displays the first 100 palindromic prime numbers. Display 10 numbers per line, separated by exactly one space, as follows:

```
2 3 5 7 11 101 131 151 181 191
313 353 373 383 727 757 787 797 919 929
...
```

- **5.27** (*Emirp*) An *emirp* (prime spelled backward) is a nonpalindromic prime number whose reversal is also a prime. For example, 17 is a prime and 71 is a prime, so 17 and 71 are emirps. Write a program that displays the first 100 emirps. Display 10 numbers per line, separated by exactly one space, as follows:

```
13 17 31 37 71 73 79 97 107 113
149 157 167 179 199 311 337 347 359 389
...
```

- **5.28** (*Mersenne prime*) A prime number is called a *Mersenne prime* if it can be written in the form $2^p - 1$ for some positive integer p . Write a program that finds all Mersenne primes with $p \leq 31$ and displays the output as follows:

p	$2^p - 1$
2	3
3	7
5	31
...	

- **5.29** (*Twin primes*) Twin primes are a pair of prime numbers that differ by 2. For example, 3 and 5 are twin primes, 5 and 7 are twin primes, and 11 and 13 are twin primes. Write a program to find all twin primes less than 1,000. Display the output as follows:

```
(3, 5)
(5, 7)
...
```

- **5.30** (*Game: craps*) Craps is a popular dice game played in casinos. Write a program to play a variation of the game, as follows:

Roll two dice. Each die has six faces representing values 1, 2, . . . , and 6, respectively. Check the sum of the two dice. If the sum is 2, 3, or 12 (called *craps*), you lose; if the sum is 7 or 11 (called *natural*), you win; if the sum is another value (i.e., 4, 5, 6, 8, 9, or 10), a point is established. Continue to roll the dice until either a 7 or the same point value is rolled. If 7 is rolled, you lose. Otherwise, you win.

Your program acts as a single player. Here are some sample runs.



```
You rolled 5 + 6 = 11
You win
```

You rolled $1 + 2 = 3$
You lose



You rolled $4 + 4 = 8$
point is 8
You rolled $6 + 2 = 8$
You win



You rolled $3 + 2 = 5$
point is 5
You rolled $2 + 5 = 7$
You lose

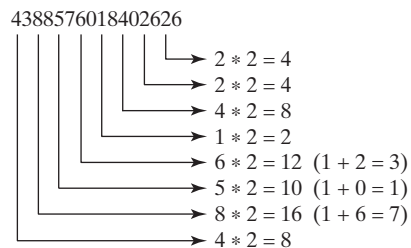


****5.31** (*Financial: credit card number validation*) Credit card numbers follow certain patterns. A credit card number must have between 13 and 16 digits. It must start with:

- 4 for Visa cards
- 5 for Master cards
- 37 for American Express cards
- 6 for Discover cards

In 1954, Hans Luhn of IBM proposed an algorithm for validating credit card numbers. The algorithm is useful to determine whether a card number is entered correctly or whether a credit card is scanned correctly by a scanner. Credit card numbers are generated following this validity check, commonly known as the *Luhn check* or the *Mod 10 check*, which can be described as follows (for illustration, consider the card number 4388576018402626):

1. Double every second digit from right to left. If doubling of a digit results in a two-digit number, add up the two digits to get a single-digit number.



2. Now add all single-digit numbers from Step 1.

$$4 + 4 + 8 + 2 + 3 + 1 + 7 + 8 = 37$$

3. Add all digits in the odd places from right to left in the card number.

$$6 + 6 + 0 + 8 + 0 + 7 + 8 + 3 = 38$$

4. Sum the results from Step 2 and Step 3.

$$37 + 38 = 75$$

5. If the result from Step 4 is divisible by 10, the card number is valid; otherwise, it is invalid. For example, the number 4388576018402626 is invalid, but the number 4388576018410707 is valid.

Write a program that prompts the user to enter a credit card number as a **long** integer. Display whether the number is valid or invalid. Design your program to use the following methods:

```

/** Return true if the card number is valid */
public static boolean isValid(long number)

/** Get the result from Step 2 */
public static int sumOfDoubleEvenPlace(long number)

/** Return this number if it is a single digit, otherwise,
 * return the sum of the two digits */
public static int getDigit(int number)

/** Return sum of odd-place digits in number */
public static int sumOfOddPlace(long number)

/** Return true if the digit d is a prefix for number */
public static boolean prefixMatched(long number, int d)

/** Return the number of digits in d */
public static int getSize(long d)

/** Return the first k number of digits from number. If the
 * number of digits in number is less than k, return number. */
public static long getPrefix(long number, int k)

```

Here are sample runs of the program:



```

Enter a credit card number as a long integer:
4388576018410707 ↵ Enter
4388576018410707 is valid

```



```

Enter a credit card number as a long integer:
4388576018402626 ↵ Enter
4388576018402626 is invalid

```

****5.32** (*Game: chance of winning at craps*) Revise Exercise 5.30 to run it 10,000 times and display the number of winning games.

****5.33** (*Current date and time*) Invoking `System.currentTimeMillis()` returns the elapsed time in milliseconds since midnight of January 1, 1970. Write a program that displays the date and time. Here is a sample run:



```

Current date and time is May 16, 2012 10:34:23

```


****5.34** (*Print calendar*) Programming Exercise 3.21 uses Zeller's congruence to calculate the day of the week. Simplify Listing 5.12, `PrintCalendar.java`, using Zeller's algorithm to get the start day of the month.

5.35 (*Geometry: area of a pentagon*) The area of a pentagon can be computed using the following formula:

$$\text{Area} = \frac{5 \times s^2}{4 \times \tan\left(\frac{\pi}{5}\right)}$$

Write a program that prompts the user to enter the side of a pentagon and displays the area. Here is a sample run:

```
Enter the side: 5.5 ↵ Enter
The area of the pentagon is 52.04444136781625
```



***5.36** (*Geometry: area of a regular polygon*) A regular polygon is an n -sided polygon in which all sides are of the same length and all angles have the same degree (i.e., the polygon is both equilateral and equiangular). The formula for computing the area of a regular polygon is

$$\text{Area} = \frac{n \times s^2}{4 \times \tan\left(\frac{\pi}{n}\right)}$$

Write a method that returns the area of a regular polygon using the following header:

```
public static double area(int n, double side)
```

Write a main method that prompts the user to enter the number of sides and the side of a regular polygon and displays its area. Here is a sample run:

```
Enter the number of sides: 5 ↵ Enter
Enter the side: 6.5 ↵ Enter
The area of the polygon is 72.69017017488385
```



5.37 (*Format an integer*) Write a method with the following header to format the integer with the specified width.

```
public static String format(int number, int width)
```

The method returns a string for the number with one or more prefix `0`s. The size of the string is the width. For example, `format(34, 4)` returns `0034` and `format(34, 5)` returns `00034`. If the number is longer than the width, the method returns the string representation for the number. For example, `format(34, 1)` returns `34`.

Write a test program that prompts the user to enter a number and its width and displays a string returned by invoking `format(number, width)`.

***5.38** (*Generate random characters*) Use the methods in `RandomCharacter` in Listing 5.10 to print 100 uppercase letters and then 100 single digits, printing ten per line.

5.39 (*Geometry: point position*) Programming Exercise 3.32 shows how to test whether a point is on the left side of a directed line, on the right, or on the same line. Write the methods with the following headers:

```
/** Return true if point (x2, y2) is on the left side of the
 * directed line from (x0, y0) to (x1, y1) */
public static boolean leftOfTheLine(double x0, double y0,
    double x1, double y1, double x2, double y2)

/** Return true if point (x2, y2) is on the same
 * line from (x0, y0) to (x1, y1) */
public static boolean onTheSameLine(double x0, double y0,
    double x1, double y1, double x2, double y2)

/** Return true if point (x2, y2) is on the
 * line segment from (x0, y0) to (x1, y1) */
public static boolean onTheLineSegment(double x0, double y0,
    double x1, double y1, double x2, double y2)
```

Write a program that prompts the user to enter the three points for `p0`, `p1`, and `p2` and displays whether `p2` is on the left of the line from `p0` to `p1`, right, the same line, or on the line segment. Here are some sample runs:



Enter three points for p0, p1, and p2: 1 1 2 2 1.5 1.5 ↵ Enter
(1.5, 1.5) is on the line segment from (1.0, 1.0) to (2.0, 2.0)



Enter three points for p0, p1, and p2: 1 1 2 2 3 3 ↵ Enter
(3.0, 3.0) is on the same line from (1.0, 1.0) to (2.0, 2.0)



Enter three points for p0, p1, and p2: 1 1 2 2 1 1.5 ↵ Enter
(1.0, 1.5) is on the left side of the line
from (1.0, 1.0) to (2.0, 2.0)



Enter three points for p0, p1, and p2: 1 1 2 2 1 -1 ↵ Enter
(1.0, -1.0) is on the right side of the line
from (1.0, 1.0) to (2.0, 2.0)

SINGLE-DIMENSIONAL ARRAYS

Objectives

- To describe why arrays are necessary in programming (§6.1).
- To declare array reference variables and create arrays (§§6.2.1–6.2.2).
- To obtain array size using `arrayRefVar.length` and know default values in an array (§6.2.3).
- To access array elements using indexed variables (§6.2.4).
- To declare, create, and initialize an array using an array initializer (§6.2.5).
- To program common array operations (displaying arrays, summing all elements, finding the minimum and maximum elements, random shuffling, and shifting elements) (§6.2.6).
- To simplify programming using the for-each loops (§6.2.7).
- To apply arrays in application development (`LottoNumbers`, `DeckOfCards`) (§§6.3–6.4).
- To copy contents from one array to another (§6.5).
- To develop and invoke methods with array arguments and return values (§§6.6–6.8).
- To define a method with a variable-length argument list (§6.9).
- To search elements using the linear (§6.10.1) or binary (§6.10.2) search algorithm.
- To sort an array using the selection sort approach (§6.11.1).
- To sort an array using the insertion sort approach (§6.11.2).
- To use the methods in the `java.util.Arrays` class (§6.12).



6.1 Introduction



A single array variable can reference a large collection of data.

problem
why array?

Often you will have to store a large number of values during the execution of a program. Suppose, for instance, that you need to read 100 numbers, compute their average, and find out how many numbers are above the average. Your program first reads the numbers and computes their average, then compares each number with the average to determine whether it is above the average. In order to accomplish this task, the numbers must all be stored in variables. You have to declare 100 variables and repeatedly write almost identical code 100 times. Writing a program this way would be impractical. So, how do you solve this problem?

what is array?

An efficient, organized approach is needed. Java and most other high-level languages provide a data structure, the *array*, which stores a fixed-size sequential collection of elements of the same type. In the present case, you can store all 100 numbers into an array and access them through a single array variable. The solution may look like this:

create array

```

1 public class AnalyzeNumbers {
2     public static void main(String[] args) {
3         final int NUMBER_OF_ELEMENTS = 100;
4         double[] numbers = new double[NUMBER_OF_ELEMENTS];
5         double sum = 0;
6
7         java.util.Scanner input = new java.util.Scanner(System.in);
8         for (int i = 0; i < NUMBER_OF_ELEMENTS; i++) {
9             System.out.print("Enter a new number: ");
10            numbers[i] = input.nextDouble();
11            sum += numbers[i];
12        }
13
14        double average = sum / NUMBER_OF_ELEMENTS;
15
16        int count = 0; // The number of elements above average
17        for (int i = 0; i < NUMBER_OF_ELEMENTS; i++)
18            if (numbers[i] > average)
19                count++;
20
21        System.out.println("Average is " + average);
22        System.out.println("Number of elements above the average "
23            + count);
24    }
25 }
```

numbers	array
numbers[0]:	<input type="text"/>
numbers[1]:	<input type="text"/>
numbers[2]:	<input type="text"/>
...	.
numbers[i]	.
...	.
numbers[97]:	<input type="text"/>
numbers[98]:	<input type="text"/>
numbers[99]:	<input type="text"/>

store number in array

get average

above average?

The program creates an array of **100** elements in line 4, stores numbers into the array in line 10, adds each number to **sum** in line 11, and obtains the average in line 14. It then compares each number in the array with the average to count the number of values above the average (lines 16–19).

This chapter introduces single-dimensional arrays. The next chapter will introduce two-dimensional and multidimensional arrays.

6.2 Array Basics



Once an array is created, its size is fixed. An array reference variable is used to access the elements in an array using an index.

index

An array is used to store a collection of data, but often we find it more useful to think of an array as a collection of variables of the same type. Instead of declaring individual variables, such as **number0**, **number1**, . . . , and **number99**, you declare one array variable such as **numbers** and use **numbers[0]**, **numbers[1]**, . . . , and **numbers[99]** to represent individual variables.

This section introduces how to declare array variables, create arrays, and process arrays using indexed variables.

6.2.1 Declaring Array Variables

To use an array in a program, you must declare a variable to reference the array and specify the array's *element type*. Here is the syntax for declaring an array variable:

```
elementType[] arrayRefVar;
```

element type

The **elementType** can be any data type, and all elements in the array will have the same data type. For example, the following code declares a variable **myList** that references an array of double elements.

```
double[] myList;
```



Note

You can also use **elementType arrayRefVar[]** to declare an array variable. This style comes from the C language and was adopted in Java to accommodate C programmers. The style **elementType[] arrayRefVar** is preferred.

preferred syntax

6.2.2 Creating Arrays

Unlike declarations for primitive data type variables, the declaration of an array variable does not allocate any space in memory for the array. It creates only a storage location for the reference to an array. If a variable does not contain a reference to an array, the value of the variable is **null**. You cannot assign elements to an array unless it has already been created. After an array variable is declared, you can create an array by using the **new** operator with the following syntax:

null

```
arrayRefVar = new elementType[arraySize];
```

new operator

This statement does two things: (1) it creates an array using **new elementType[arraySize]**; (2) it assigns the reference of the newly created array to the variable **arrayRefVar**.

Declaring an array variable, creating an array, and assigning the reference of the array to the variable can be combined in one statement as:

```
elementType[] arrayRefVar = new elementType[arraySize];
```

or

```
elementType arrayRefVar[] = new elementType[arraySize];
```

Here is an example of such a statement:

```
double[] myList = new double[10];
```

This statement declares an array variable, **myList**, creates an array of ten elements of **double** type, and assigns its reference to **myList**. To assign values to the elements, use the syntax:

```
arrayRefVar[index] = value;
```

For example, the following code initializes the array.

```
myList[0] = 5.6;
myList[1] = 4.5;
myList[2] = 3.3;
myList[3] = 13.2;
```

```

myList[4] = 4.0;
myList[5] = 34.33;
myList[6] = 34.0;
myList[7] = 45.45;
myList[8] = 99.993;
myList[9] = 11123;

```

This array is illustrated in Figure 6.1.

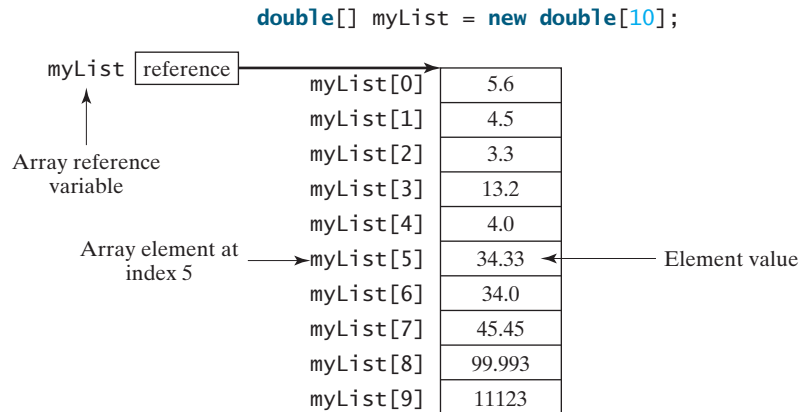


FIGURE 6.1 The array `myList` has ten elements of `double` type and `int` indices from `0` to `9`.



Note

An array variable that appears to hold an array actually contains a reference to that array. Strictly speaking, an array variable and an array are different, but most of the time the distinction can be ignored. Thus it is all right to say, for simplicity, that `myList` is an array, instead of stating, at greater length, that `myList` is a variable that contains a reference to an array of ten double elements.

array vs. array variable

6.2.3 Array Size and Default Values

array length

When space for an array is allocated, the array size must be given, specifying the number of elements that can be stored in it. The size of an array cannot be changed after the array is created. Size can be obtained using `arrayRefVar.length`. For example, `myList.length` is `10`.

default values

When an array is created, its elements are assigned the default value of `0` for the numeric primitive data types, `\u0000` for `char` types, and `false` for `boolean` types.

6.2.4 Array Indexed Variables

0 based

The array elements are accessed through the index. Array indices are `0` based; that is, they range from `0` to `arrayRefVar.length-1`. In the example in Figure 6.1, `myList` holds ten `double` values, and the indices are from `0` to `9`.

indexed variable

Each element in the array is represented using the following syntax, known as an *indexed variable*:

```
arrayRefVar[index];
```

For example, `myList[9]` represents the last element in the array `myList`.



Caution

Some programming languages use parentheses to reference an array element, as in `myList(9)`, but Java uses brackets, as in `myList[9]`.

After an array is created, an indexed variable can be used in the same way as a regular variable. For example, the following code adds the values in `myList[0]` and `myList[1]` to `myList[2]`.

```
myList[2] = myList[0] + myList[1];
```

The following loop assigns `0` to `myList[0]`, `1` to `myList[1]`, . . . , and `9` to `myList[9]`:

```
for (int i = 0; i < myList.length; i++) {
    myList[i] = i;
}
```

6.2.5 Array Initializers

Java has a shorthand notation, known as the *array initializer*, which combines the declaration, array initializer creation, and initialization of an array in one statement using the following syntax:

```
elementType[] arrayRefVar = {value0, value1, ..., valuek};
```

For example, the statement

```
double[] myList = {1.9, 2.9, 3.4, 3.5};
```

declares, creates, and initializes the array `myList` with four elements, which is equivalent to the following statements:

```
double[] myList = new double[4];
myList[0] = 1.9;
myList[1] = 2.9;
myList[2] = 3.4;
myList[3] = 3.5;
```



Caution

The `new` operator is not used in the array-initializer syntax. Using an array initializer, you have to declare, create, and initialize the array all in one statement. Splitting it would cause a syntax error. Thus, the next statement is wrong:

```
double[] myList;
myList = {1.9, 2.9, 3.4, 3.5};
```

6.2.6 Processing Arrays

When processing array elements, you will often use a `for` loop—for two reasons:

- All of the elements in an array are of the same type. They are evenly processed in the same fashion repeatedly using a loop.
- Since the size of the array is known, it is natural to use a `for` loop.

Assume the array is created as follows:

```
double[] myList = new double[10];
```

The following are some examples of processing arrays.

1. *Initializing arrays with input values:* The following loop initializes the array `myList` with user input values.

```
java.util.Scanner input = new java.util.Scanner(System.in);
System.out.print("Enter " + myList.length + " values: ");
for (int i = 0; i < myList.length; i++)
    myList[i] = input.nextDouble();
```

2. *Initializing arrays with random values:* The following loop initializes the array `myList` with random values between `0.0` and `100.0`, but less than `100.0`.

```
for (int i = 0; i < myList.length; i++) {
    myList[i] = Math.random() * 100;
}
```

3. *Displaying arrays:* To print an array, you have to print each element in the array using a loop like the following:

```
for (int i = 0; i < myList.length; i++) {
    System.out.print(myList[i] + " ");
}
```

print character array



Tip

For an array of the `char[]` type, it can be printed using one print statement. For example, the following code displays `Dallas`:

```
char[] city = {'D', 'a', 'l', 'l', 'a', 's'};
System.out.println(city);
```

4. *Summing all elements:* Use a variable named `total` to store the sum. Initially `total` is `0`. Add each element in the array to `total` using a loop like this:

```
double total = 0;
for (int i = 0; i < myList.length; i++) {
    total += myList[i];
}
```

5. *Finding the largest element:* Use a variable named `max` to store the largest element. Initially `max` is `myList[0]`. To find the largest element in the array `myList`, compare each element with `max`, and update `max` if the element is greater than `max`.

```
double max = myList[0];
for (int i = 1; i < myList.length; i++) {
    if (myList[i] > max) max = myList[i];
}
```

6. *Finding the smallest index of the largest element:* Often you need to locate the largest element in an array. If an array has more than one largest element, find the smallest index of such an element. Suppose the array `myList` is `{1, 5, 3, 4, 5, 5}`. The largest element is `5` and the smallest index for `5` is `1`. Use a variable named `max` to store the largest element and a variable named `indexOfMax` to denote the index of the largest element. Initially `max` is `myList[0]`, and `indexOfMax` is `0`. Compare each element in `myList` with `max`, and update `max` and `indexOfMax` if the element is greater than `max`.

```
double max = myList[0];
int indexOfMax = 0;
for (int i = 1; i < myList.length; i++) {
    if (myList[i] > max) {
        max = myList[i];
        indexOfMax = i;
    }
}
```



VideoNote

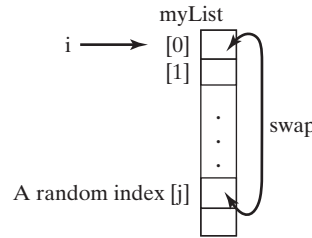
Random shuffling

7. *Random shuffling:* In many applications, you need to randomly reorder the elements in an array. This is called *shuffling*. To accomplish this, for each element

`myList[i]`, randomly generate an index `j` and swap `myList[i]` with `myList[j]`, as follows:

```
for (int i = 0; i < myList.length; i++) {
    // Generate an index j randomly
    int j = (int) (Math.random()
        * myList.length);

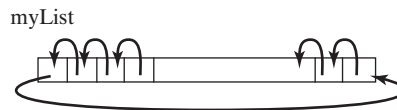
    // Swap myList[i] with myList[j]
    double temp = myList[i];
    myList[i] = myList[j];
    myList[j] = temp;
}
```



8. *Shifting elements*: Sometimes you need to shift the elements left or right. Here is an example of shifting the elements one position to the left and filling the last element with the first element:

```
double temp = myList[0]; // Retain the first element
```

```
// Shift elements left
for (int i = 1; i < myList.length; i++) {
    myList[i - 1] = myList[i];
}
```



```
// Move the first element to fill in the last position
myList[myList.length - 1] = temp;
```

9. *Simplifying coding*: Arrays can be used to greatly simplify coding for certain tasks. For example, suppose you wish to obtain the English name of a given month by its number. If the month names are stored in an array, the month name for a given month can be accessed simply via the index. The following code prompts the user to enter a month number and displays its month name:

```
String[] months = {"January", "February", ..., "December"};
System.out.print("Enter a month number (1 to 12): ");
int monthNumber = input.nextInt();
System.out.println("The month is " + months[monthNumber - 1]);
```

If you didn't use the `months` array, you would have to determine the month name using a lengthy multi-way `if-else` statement as follows:

```
if (monthNumber == 1)
    System.out.println("The month is January");
else if (monthNumber == 2)
    System.out.println("The month is February");
...
else
    System.out.println("The month is December");
```

6.2.7 for-each Loops

Java supports a convenient `for` loop, known as a *for-each loop* or *enhanced for loop*, which enables you to traverse the array sequentially without using an index variable. For example, the following code displays all the elements in the array `myList`:

```
for (double u: myList) {
    System.out.println(u);
}
```

You can read the code as “for each element **u** in **myList**, do the following.” Note that the variable, **u**, must be declared as the same type as the elements in **myList**.

In general, the syntax for a for-each loop is

```
for (elementType element: arrayRefVar) {
    // Process the element
}
```

You still have to use an index variable if you wish to traverse the array in a different order or change the elements in the array.



Caution

Accessing an array out of bounds is a common programming error that throws a runtime **ArrayIndexOutOfBoundsException**. To avoid it, make sure that you do not use an index beyond **arrayRefVar.length - 1**.

Programmers often mistakenly reference the first element in an array with index **1**, but it should be **0**. This is called the *off-by-one error*. Another common error in a loop is using **<=** where **<** should be used. For example, the following loop is wrong.

```
for (int i = 0; i <= list.length; i++)
    System.out.print(list[i] + " ");
```

The **<=** should be replaced by **<**.

ArrayIndexOutOfBoundsException

off-by-one error



MyProgrammingLab™

- 6.1 How do you declare an array reference variable and how do you create an array?
- 6.2 When is the memory allocated for an array?
- 6.3 What is the printout of the following code?

```
int x = 30;
int[] numbers = new int[x];
x = 60;
System.out.println("x is " + x);
System.out.println("The size of numbers is " + numbers.length);
```

- 6.4 Indicate **true** or **false** for the following statements:
 - Every element in an array has the same type.
 - The array size is fixed after an array reference variable is declared.
 - The array size is fixed after it is created.
 - The elements in an array must be a primitive data type.
- 6.5 Which of the following statements are valid?


```
int i = new int(30);
double d[] = new double[30];
char[] r = new char(1..30);
int i[] = (3, 4, 3, 2);
float f[] = {2.3, 4.5, 6.6};
char[] c = new char();
```
- 6.6 How do you access elements in an array? What is an array indexed variable?
- 6.7 What is the array index type? What is the lowest index? What is the representation of the third element in an array named **a**?
- 6.8 Write statements to do the following:
 - a. Create an array to hold **10** double values.
 - b. Assign the value **5.5** to the last element in the array.
 - c. Display the sum of the first two elements.
 - d. Write a loop that computes the sum of all elements in the array.

- e. Write a loop that finds the minimum element in the array.
- f. Randomly generate an index and display the element of this index in the array.
- g. Use an array initializer to create another array with the initial values 3.5, 5.5, 4.52, and 5.6.

6.9 What happens when your program attempts to access an array element with an invalid index?

6.10 Identify and fix the errors in the following code:

```

1 public class Test {
2     public static void main(String[] args) {
3         double[100] r;
4
5         for (int i = 0; i < r.length(); i++);
6             r(i) = Math.random * 100;
7     }
8 }
```

6.11 What is the output of the following code?

```

1 public class Test {
2     public static void main(String[] args) {
3         int list[] = {1, 2, 3, 4, 5, 6};
4         for (int i = 1; i < list.length; i++)
5             list[i] = list[i - 1];
6
7         for (int i = 0; i < list.length; i++)
8             System.out.print(list[i] + " ");
9     }
10 }
```

6.3 Case Study: Lotto Numbers

The problem is to write a program that checks if all the input numbers cover 1 to 99.

Each ticket for the Pick-10 lotto has 10 unique numbers ranging from 1 to 99. Suppose you buy a lot of tickets and like to have them cover all numbers from 1 to 99. Write a program that reads the ticket numbers from a file and checks whether all numbers are covered. Assume the last number in the file is 0. Suppose the file contains the numbers

```

80 3 87 62 30 90 10 21 46 27
12 40 83 9 39 88 95 59 20 37
80 40 87 67 31 90 11 24 56 77
11 48 51 42 8 74 1 41 36 53
52 82 16 72 19 70 44 56 29 33
54 64 99 14 23 22 94 79 55 2
60 86 34 4 31 63 84 89 7 78
43 93 97 45 25 38 28 26 85 49
47 65 57 67 73 69 32 71 24 66
92 98 96 77 6 75 17 61 58 13
35 81 18 15 5 68 91 50 76
0
```

Your program should display

```
The tickets cover all numbers
```

Suppose the file contains the numbers

```

11 48 51 42 8 74 1 41 36 53
52 82 16 72 19 70 44 56 29 33
0
```



VideoNote

Lotto numbers

Your program should display

The tickets don't cover all numbers

How do you mark a number as covered? You can create an array with **99 boolean** elements. Each element in the array can be used to mark whether a number is covered. Let the array be **isCovered**. Initially, each element is **false**, as shown in Figure 6.2a. Whenever a number is read, its corresponding element is set to **true**. Suppose the numbers entered are **1, 2, 3, 99, 0**. When number **1** is read, **isCovered[0]** is set to **true** (see Figure 6.2b). When number **2** is read, **isCovered[2 - 1]** is set to **true** (see Figure 6.2c). When number **3** is read, **isCovered[3 - 1]** is set to **true** (see Figure 6.2d). When number **99** is read, **isCovered[98]** is set to **true** (see Figure 6.2e).

	isCovered	isCovered	isCovered	isCovered	isCovered
[0]	false	true	true	true	true
[1]	false	false	true	true	true
[2]	false	false	false	true	true
[3]	false	false	false	false	false

[97]	false	false	false	false	false
[98]	false	false	false	false	true

(a) (b) (c) (d) (e)

FIGURE 6.2 If number **i** appears in a Lotto ticket, **isCovered[i-1]** is set to **true**.

The algorithm for the program can be described as follows:

```

for each number k read from the file,
    mark number k as covered by setting isCovered[k - 1] true;
if every isCovered[i] is true
    The tickets cover all numbers
else
    The tickets don't cover all numbers
  
```

The complete program is given in Listing 6.1.

LISTING 6.1 LottoNumbers.java

```

1  import java.util.Scanner;
2
3  public class LottoNumbers {
4      public static void main(String[] args) {
5          Scanner input = new Scanner(System.in);
6          boolean[] isCovered = new boolean[99]; // Default is false
7
8          // Read each number and mark its corresponding element covered
9          int number = input.nextInt();
10         while (number != 0) {
11             isCovered[number - 1] = true;
12             number = input.nextInt();
13         }
14
15     }
  
```

create and initialize array

read number

mark number covered

read number

```

15 // Check whether all covered
16 boolean allCovered = true; // Assume all covered initially
17 for (int i = 0; i < isCovered.length; i++)
18     if (!isCovered[i]) {
19         allCovered = false; // Find one number not covered
20         break;
21     }
22
23 // Display result
24 if (allCovered)
25     System.out.println("The tickets cover all numbers");
26 else
27     System.out.println("The tickets don't cover all numbers");
28 }
29 }

```

check allCovered?

Suppose you have created a text file named LottoNumbers.txt that contains the input data **2 5 6 5 4 3 23 43 2 0**. You can run the program using the following command:

```
java LottoNumbers < LottoNumbers.txt
```

The program can be traced as follows:

Line#	Representative elements in array isCovered							number	allCovered
	[1]	[2]	[3]	[4]	[5]	[22]	[42]		
6	false	false	false	false	false	false	false		
9								2	
11	true								
12								5	
11				true					
12								6	
11					true				
12								5	
11				true					
12								4	
11			true						
12								3	
11	true								
12								23	
11						true			
12								43	
11							true		
12								2	
11	true								
12								0	
16									true
18(i=0)									false



The program creates an array of **99 boolean** elements and initializes each element to **false** (line 6). It reads the first number from the file (line 9). The program then repeats the following operations in a loop:

- If the number is not zero, set its corresponding value in array **isCovered** to **true** (line 11);
- Read the next number (line 12).

When the input is **0**, the input ends. The program checks whether all numbers are covered in lines 16–21 and displays the result in lines 24–27.

6.4 Case Study: Deck of Cards



The problem is to create a program that will randomly select four cards from a deck of cards.

Say you want to write a program that will pick four cards at random from a deck of **52** cards. All the cards can be represented using an array named **deck**, filled with initial values **0** to **51**, as follows:

```
int[] deck = new int[52];

// Initialize cards
for (int i = 0; i < deck.length; i++)
    deck[i] = i;
```

Card numbers **0** to **12**, **13** to **25**, **26** to **38**, and **39** to **51** represent 13 Spades, 13 Hearts, 13 Diamonds, and 13 Clubs, respectively, as shown in Figure 6.3. **cardNumber / 13** determines the suit of the card and **cardNumber % 13** determines the rank of the card, as shown in Figure 6.4. After shuffling the array **deck**, pick the first four cards from **deck**. The program displays the cards from these four card numbers.

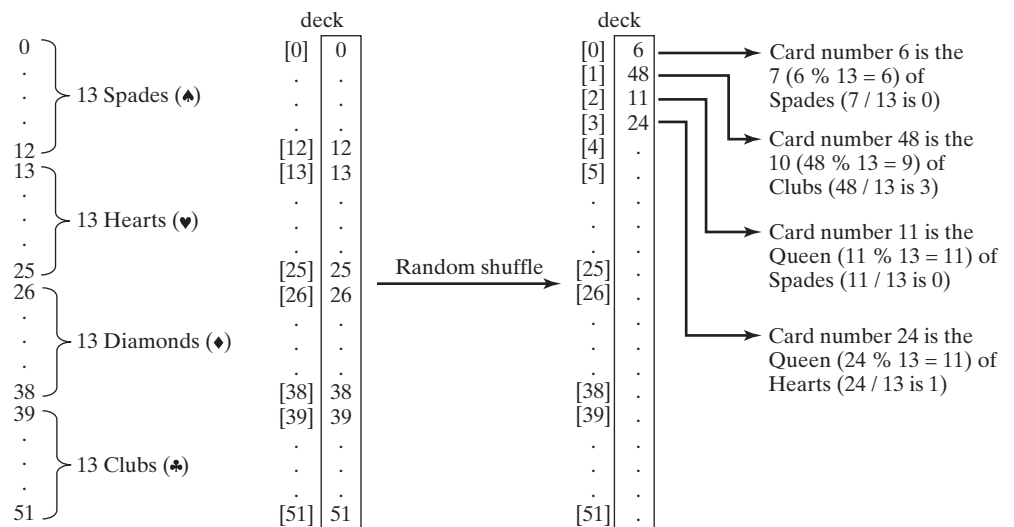


FIGURE 6.3 52 cards are stored in an array named **deck**.

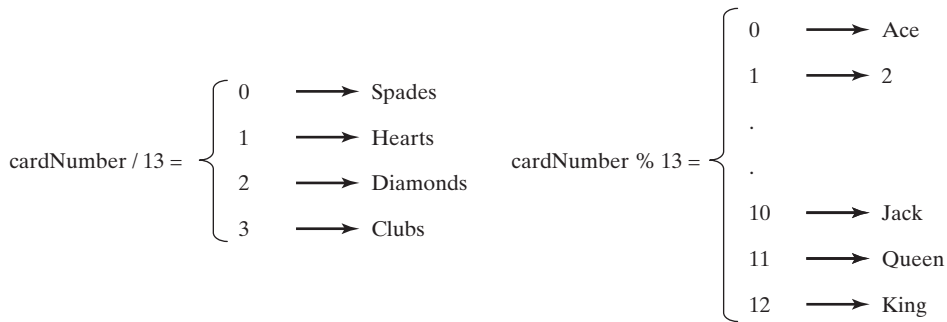


FIGURE 6.4 How `cardNumber` identifies a card's suit and rank number.

Listing 6.2 gives the solution to the problem.

LISTING 6.2 DeckOfCards.java

```

1 public class DeckOfCards {
2     public static void main(String[] args) {
3         int[] deck = new int[52];
4         String[] suits = {"Spades", "Hearts", "Diamonds", "Clubs"};
5         String[] ranks = {"Ace", "2", "3", "4", "5", "6", "7", "8", "9",
6             "10", "Jack", "Queen", "King"};
7
8         // Initialize the cards
9         for (int i = 0; i < deck.length; i++)
10            deck[i] = i;
11
12        // Shuffle the cards
13        for (int i = 0; i < deck.length; i++) {
14            // Generate an index randomly
15            int index = (int)(Math.random() * deck.length);
16            int temp = deck[i];
17            deck[i] = deck[index];
18            deck[index] = temp;
19        }
20
21        // Display the first four cards
22        for (int i = 0; i < 4; i++) {
23            String suit = suits[deck[i] / 13];
24            String rank = ranks[deck[i] % 13];
25            System.out.println("Card number " + deck[i] + ": "
26                + rank + " of " + suit);
27        }
28    }
29 }

```

create array deck
array of strings
array of strings

initialize deck

shuffle deck

suit of a card
rank of a card

```

Card number 6: 7 of Spades
Card number 48: 10 of Clubs
Card number 11: Queen of Spades
Card number 24: Queen of Hearts

```



The program defines an array `suits` for four suits (line 4) and an array `ranks` for 13 cards in a suit (lines 5–6). Each element in these arrays is a string.

The program initializes `deck` with values `0` to `51` in lines 9–10. The `deck` value `0` represents the card Ace of Spades, `1` represents the card 2 of Spades, `13` represents the card Ace of Hearts, and `14` represents the card 2 of Hearts.

Lines 13–19 randomly shuffle the deck. After a deck is shuffled, `deck[i]` contains an arbitrary value. `deck[i] / 13` is `0`, `1`, `2`, or `3`, which determines the suit (line 23). `deck[i] % 13` is a value between `0` and `12`, which determines the rank (line 24). If the `suits` array is not defined, you would have to determine the suit using a lengthy multi-way `if-else` statement as follows:

```
if (deck[i] / 13 == 0)
    System.out.print("suit is Spades");
else if (deck[i] / 13 == 1)
    System.out.print("suit is Hearts");
else if (deck[i] / 13 == 2)
    System.out.print("suit is Diamonds");
else
    System.out.print("suit is Clubs");
```

With `suits = {"Spades", "Hearts", "Diamonds", "Clubs"}` created in an array, `suits[deck / 13]` gives the suit for the `deck`. Using arrays greatly simplifies the solution for this program.

6.5 Copying Arrays



To copy the contents of one array into another, you have to copy the array's individual elements into the other array.

Often, in a program, you need to duplicate an array or a part of an array. In such cases you could attempt to use the assignment statement (`=`), as follows:

```
list2 = list1;
```

However, this statement does not copy the contents of the array referenced by `list1` to `list2`, but instead merely copies the reference value from `list1` to `list2`. After this statement, `list1` and `list2` reference the same array, as shown in Figure 6.5. The array previously referenced by `list2` is no longer referenced; it becomes garbage, which will be automatically collected by the Java Virtual Machine (this process is called *garbage collection*).

copy reference

garbage collection

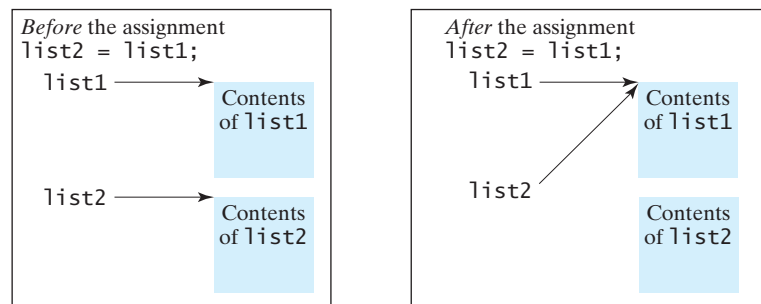


FIGURE 6.5 Before the assignment statement, `list1` and `list2` point to separate memory locations. After the assignment, the reference of the `list1` array is passed to `list2`.

In Java, you can use assignment statements to copy primitive data type variables, but not arrays. Assigning one array variable to another array variable actually copies one reference to another and makes both variables point to the same memory location.

There are three ways to copy arrays:

- Use a loop to copy individual elements one by one.
- Use the static `arraycopy` method in the `System` class.
- Use the `clone` method to copy arrays; this will be introduced in Chapter 15, Abstract Classes and Interfaces.

You can write a loop to copy every element from the source array to the corresponding element in the target array. The following code, for instance, copies `sourceArray` to `targetArray` using a `for` loop.

```
int[] sourceArray = {2, 3, 1, 5, 10};
int[] targetArray = new int[sourceArray.length];
for (int i = 0; i < sourceArray.length; i++) {
    targetArray[i] = sourceArray[i];
}
```

Another approach is to use the `arraycopy` method in the `java.lang.System` class to copy arraycopy method arrays instead of using a loop. The syntax for `arraycopy` is:

```
arraycopy(sourceArray, src_pos, targetArray, tar_pos, length);
```

The parameters `src_pos` and `tar_pos` indicate the starting positions in `sourceArray` and `targetArray`, respectively. The number of elements copied from `sourceArray` to `targetArray` is indicated by `length`. For example, you can rewrite the loop using the following statement:

```
System.arraycopy(sourceArray, 0, targetArray, 0, sourceArray.length);
```

The `arraycopy` method does not allocate memory space for the target array. The target array must have already been created with its memory space allocated. After the copying takes place, `targetArray` and `sourceArray` have the same content but independent memory locations.



Note

The `arraycopy` method violates the Java naming convention. By convention, this method should be named `arrayCopy` (i.e., with an uppercase C).

6.12 Use the `arraycopy()` method to copy the following array to a target array `t`:

```
int[] source = {3, 4, 5};
```

6.13 Once an array is created, its size cannot be changed. Does the following code resize the array?

```
int[] myList;
myList = new int[10];
// Sometime later you want to assign a new array to myList
myList = new int[20];
```



MyProgrammingLab™

6.6 Passing Arrays to Methods

When passing an array to a method, the reference of the array is passed to the method.

Just as you can pass primitive type values to methods, you can also pass arrays to methods. For example, the following method displays the elements in an `int` array:

```
public static void printArray(int[] array) {
    for (int i = 0; i < array.length; i++) {
```



```

        System.out.print(array[i] + " ");
    }
}

```

You can invoke it by passing an array. For example, the following statement invokes the `printArray` method to display **3, 1, 2, 6, 4, and 2**.

```
printArray(new int[]{3, 1, 2, 6, 4, 2});
```



Note

The preceding statement creates an array using the following syntax:

```
new elementType[]{value0, value1, ..., valuek};
```

anonymous array

There is no explicit reference variable for the array. Such array is called an *anonymous array*.

pass-by-value

Java uses *pass-by-value* to pass arguments to a method. There are important differences between passing the values of variables of primitive data types and passing arrays.

- For an argument of a primitive type, the argument's value is passed.
- For an argument of an array type, the value of the argument is a reference to an array; this reference value is passed to the method. Semantically, it can be best described as *pass-by-sharing*, that is, the array in the method is the same as the array being passed. Thus, if you change the array in the method, you will see the change outside the method.

pass-by-sharing

Take the following code, for example:

```

public class Test {
    public static void main(String[] args) {
        int x = 1; // x represents an int value
        int[] y = new int[10]; // y represents an array of int values

        m(x, y); // Invoke m with arguments x and y

        System.out.println("x is " + x);
        System.out.println("y[0] is " + y[0]);
    }

    public static void m(int number, int[] numbers) {
        number = 1001; // Assign a new value to number
        numbers[0] = 5555; // Assign a new value to numbers[0]
    }
}

```



```

x is 1
y[0] is 5555

```

You may wonder why after `m` is invoked, `x` remains **1**, but `y[0]` become **5555**. This is because `y` and `numbers`, although they are independent variables, reference the same array, as illustrated in Figure 6.6. When `m(x, y)` is invoked, the values of `x` and `y` are passed to `number` and `numbers`. Since `y` contains the reference value to the array, `numbers` now contains the same reference value to the same array.

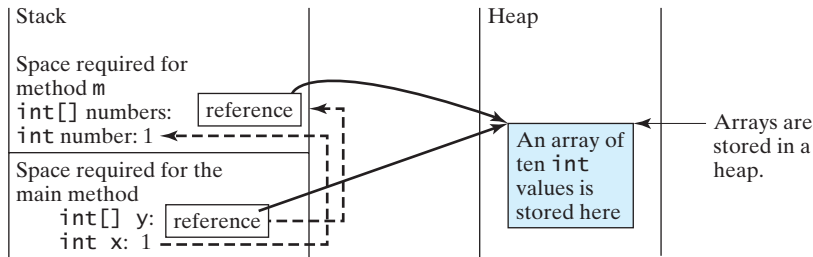


FIGURE 6.6 The primitive type value in `x` is passed to `number`, and the reference value in `y` is passed to `numbers`.



Note

Arrays are objects in Java (objects are introduced in Chapter 8). The JVM stores the objects in an area of memory called the *heap*, which is used for dynamic memory allocation.

heap

Listing 6.3 gives another program that shows the difference between passing a primitive data type value and an array reference variable to a method.

The program contains two methods for swapping elements in an array. The first method, named `swap`, fails to swap two `int` arguments. The second method, named `swapFirstTwoInArray`, successfully swaps the first two elements in the array argument.

LISTING 6.3 TestPassArray.java

```

1 public class TestPassArray {
2     /** Main method */
3     public static void main(String[] args) {
4         int[] a = {1, 2};
5
6         // Swap elements using the swap method
7         System.out.println("Before invoking swap");
8         System.out.println("array is {" + a[0] + ", " + a[1] + "}");
9         swap(a[0], a[1]);
10        System.out.println("After invoking swap");
11        System.out.println("array is {" + a[0] + ", " + a[1] + "}");
12
13        // Swap elements using the swapFirstTwoInArray method
14        System.out.println("Before invoking swapFirstTwoInArray");
15        System.out.println("array is {" + a[0] + ", " + a[1] + "}");
16        swapFirstTwoInArray(a);
17        System.out.println("After invoking swapFirstTwoInArray");
18        System.out.println("array is {" + a[0] + ", " + a[1] + "}");
19    }
20
21    /** Swap two variables */
22    public static void swap(int n1, int n2) {
23        int temp = n1;
24        n1 = n2;
25        n2 = temp;
26    }
27
28    /** Swap the first two elements in the array */
29    public static void swapFirstTwoInArray(int[] array) {
30        int temp = array[0];
31        array[0] = array[1];
32        array[1] = temp;
33    }
34 }

```

false swap

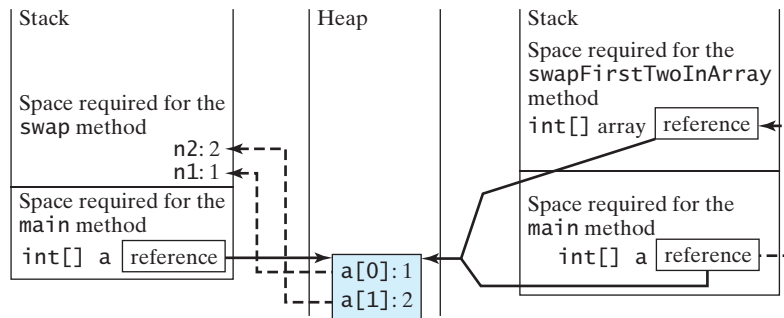
swap array elements



```

Before invoking swap
array is {1, 2}
After invoking swap
array is {1, 2}
Before invoking swapFirstTwoInArray
array is {1, 2}
After invoking swapFirstTwoInArray
array is {2, 1}
    
```

As shown in Figure 6.7, the two elements are not swapped using the `swap` method. However, they are swapped using the `swapFirstTwoInArray` method. Since the parameters in the `swap` method are primitive type, the values of `a[0]` and `a[1]` are passed to `n1` and `n2` inside the method when invoking `swap(a[0], a[1])`. The memory locations for `n1` and `n2` are independent of the ones for `a[0]` and `a[1]`. The contents of the array are not affected by this call.



Invoke `swap(int n1, int n2)`. The primitive type values in `a[0]` and `a[1]` are passed to the `swap` method. The arrays are stored in a heap. Invoke `swapFirstTwoInArray(int[] array)`. The reference value in `a` is passed to the `swapFirstTwoInArray` method.

FIGURE 6.7 When passing an array to a method, the reference of the array is passed to the method.

The parameter in the `swapFirstTwoInArray` method is an array. As shown in Figure 6.7, the reference of the array is passed to the method. Thus the variables `a` (outside the method) and `array` (inside the method) both refer to the same array in the same memory location. Therefore, swapping `array[0]` with `array[1]` inside the method `swapFirstTwoInArray` is the same as swapping `a[0]` with `a[1]` outside of the method.

6.7 Returning an Array from a Method



When a method returns an array, the reference of the array is returned.

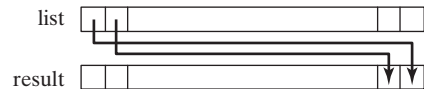
You can pass arrays when invoking a method. A method may also return an array. For example, the following method returns an array that is the reversal of another array.

```

1 public static int[] reverse(int[] list) {
2     int[] result = new int[list.length];
3
4     for (int i = 0, j = result.length - 1;
5         i < list.length; i++, j--) {
6         result[j] = list[i];
7     }
8
9     return result;
10 }
    
```

create array

return array



Line 2 creates a new array **result**. Lines 4–7 copy elements from array **list** to array **result**. Line 9 returns the array. For example, the following statement returns a new array **list2** with elements **6, 5, 4, 3, 2, 1**.

```
int[] list1 = {1, 2, 3, 4, 5, 6};
int[] list2 = reverse(list1);
```

6.8 Case Study: Counting the Occurrences of Each Letter

This section presents a program to count the occurrences of each letter in an array of characters.



The program given in Listing 6.4 does the following:

1. Generates **100** lowercase letters randomly and assigns them to an array of characters, as shown in Figure 6.8a. You can obtain a random letter by using the **getRandomLowerCaseLetter()** method in the **RandomCharacter** class in Listing 5.10.
2. Count the occurrences of each letter in the array. To do so, create an array, say **counts**, of **26 int** values, each of which counts the occurrences of a letter, as shown in Figure 6.8b. That is, **counts[0]** counts the number of **a**'s, **counts[1]** counts the number of **b**'s, and so on.

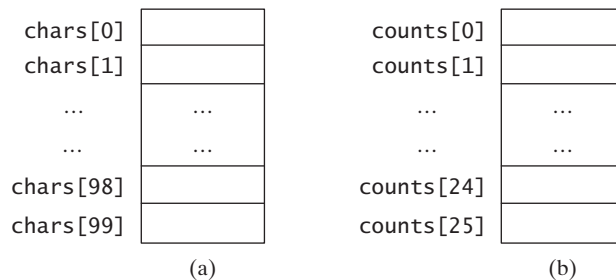


FIGURE 6.8 The **chars** array stores **100** characters, and the **counts** array stores **26** counts, each of which counts the occurrences of a letter.

LISTING 6.4 CountLettersInArray.java

```
1 public class CountLettersInArray {
2     /** Main method */
3     public static void main(String[] args) {
4         // Declare and create an array
5         char[] chars = createArray();
6
7         // Display the array
8         System.out.println("The lowercase letters are:");
9         displayArray(chars);
10
11        // Count the occurrences of each letter
12        int[] counts = countLetters(chars);
13
14        // Display counts
15        System.out.println();
16        System.out.println("The occurrences of each letter are:");
17        displayCounts(counts);
18    }
19
20    /** Create an array of characters */
```

create array

pass array

return array

pass array

```

21 public static char[] createArray() {
22     // Declare an array of characters and create it
23     char[] chars = new char[100];
24
25     // Create lowercase letters randomly and assign
26     // them to the array
27     for (int i = 0; i < chars.length; i++)
28         chars[i] = RandomCharacter.getRandomLowerCaseLetter();
29
30     // Return the array
31     return chars;
32 }
33
34 /** Display the array of characters */
35 public static void displayArray(char[] chars) {
36     // Display the characters in the array 20 on each line
37     for (int i = 0; i < chars.length; i++) {
38         if ((i + 1) % 20 == 0)
39             System.out.println(chars[i]);
40         else
41             System.out.print(chars[i] + " ");
42     }
43 }
44
45 /** Count the occurrences of each letter */
46 public static int[] countLetters(char[] chars) {
47     // Declare and create an array of 26 int
48     int[] counts = new int[26];
49
50     // For each lowercase letter in the array, count it
51     for (int i = 0; i < chars.length; i++)
52         counts[chars[i] - 'a']++;
53
54     return counts;
55 }
56
57 /** Display counts */
58 public static void displayCounts(int[] counts) {
59     for (int i = 0; i < counts.length; i++) {
60         if ((i + 1) % 10 == 0)
61             System.out.println(counts[i] + " " + (char)(i + 'a'));
62         else
63             System.out.print(counts[i] + " " + (char)(i + 'a') + " ");
64     }
65 }
66 }

```

increase count



The lowercase letters are:

```

e y l s r i b k j v j h a b z n w b t v
s c c k r d w a m p w v u n q a m p l o
a z g d e g f i n d x m z o u l o z j v
h w i w n t g x w c d o t x h y v z y z
q e a m f w p g u q t r e n n w f c r f

```

The occurrences of each letter are:

```

5 a 3 b 4 c 4 d 4 e 4 f 4 g 3 h 3 i 3 j
2 k 3 l 4 m 6 n 4 o 3 p 3 q 4 r 2 s 4 t
3 u 5 v 8 w 3 x 3 y 6 z

```

The `createArray` method (lines 21–32) generates an array of **100** random lowercase letters. Line 5 invokes the method and assigns the array to `chars`. What would be wrong if you rewrote the code as follows?

```
char[] chars = new char[100];
chars = createArray();
```

You would be creating two arrays. The first line would create an array by using `new char[100]`. The second line would create an array by invoking `createArray()` and assign the reference of the array to `chars`. The array created in the first line would be garbage because it is no longer referenced, and as mentioned earlier Java automatically collects garbage behind the scenes. Your program would compile and run correctly, but it would create an array unnecessarily.

Invoking `getRandomLowerCaseLetter()` (line 28) returns a random lowercase letter. This method is defined in the `RandomCharacter` class in Listing 5.10.

The `countLetters` method (lines 46–55) returns an array of **26** `int` values, each of which stores the number of occurrences of a letter. The method processes each letter in the array and increases its count by one. A brute-force approach to count the occurrences of each letter might be as follows:

```
for (int i = 0; i < chars.length; i++)
    if (chars[i] == 'a')
        counts[0]++;
    else if (chars[i] == 'b')
        counts[1]++;
    ...
```

But a better solution is given in lines 51–52.

```
for (int i = 0; i < chars.length; i++)
    counts[chars[i] - 'a']++;
```

If the letter (`chars[i]`) is `a`, the corresponding count is `counts['a' - 'a']` (i.e., `counts[0]`). If the letter is `b`, the corresponding count is `counts['b' - 'a']` (i.e., `counts[1]`), since the Unicode of `b` is one more than that of `a`. If the letter is `z`, the corresponding count is `counts['z' - 'a']` (i.e., `counts[25]`), since the Unicode of `z` is **25** more than that of `a`.

Figure 6.9 shows the call stack and heap *during* and *after* executing `createArray`. See Checkpoint Question 6.16 to show the call stack and heap for other methods in the program.

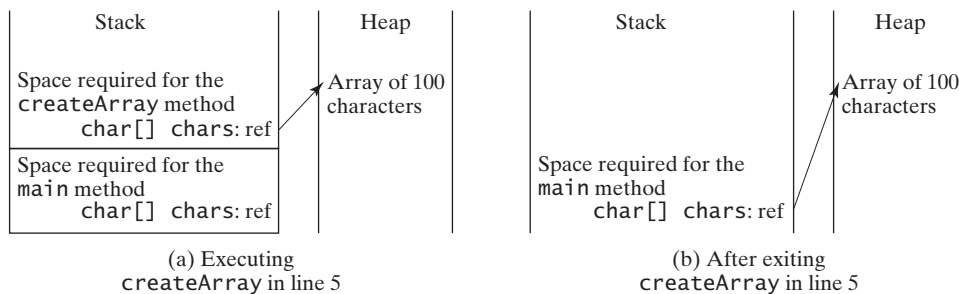


FIGURE 6.9 (a) An array of 100 characters is created when executing `createArray`. (b) This array is returned and assigned to the variable `chars` in the `main` method.



6.14 True or false? When an array is passed to a method, a new array is created and passed to the method.

MyProgrammingLab™

6.15 Show the output of the following two programs:

```
public class Test {
    public static void main(String[] args) {
        int number = 0;
        int[] numbers = new int[1];

        m(number, numbers);

        System.out.println("number is " + number
            + " and numbers[0] is " + numbers[0]);
    }

    public static void m(int x, int[] y) {
        x = 3;
        y[0] = 3;
    }
}
```

(a)

```
public class Test {
    public static void main(String[] args) {
        int[] list = {1, 2, 3, 4, 5};
        reverse(list);
        for (int i = 0; i < list.length; i++)
            System.out.print(list[i] + " ");
    }

    public static void reverse(int[] list) {
        int[] newList = new int[list.length];

        for (int i = 0; i < list.length; i++)
            newList[i] = list[list.length - 1 - i];

        list = newList;
    }
}
```

(b)

6.16 Where are the arrays stored during execution? Show the contents of the stack and heap during and after executing `displayArray`, `countLetters`, `displayCounts` in Listing 6.4.

6.9 Variable-Length Argument Lists



A variable number of arguments of the same type can be passed to a method and treated as an array.

You can pass a variable number of arguments of the same type to a method. The parameter in the method is declared as follows:

```
typeName... parameterName
```

In the method declaration, you specify the type followed by an ellipsis (...). Only one variable-length parameter may be specified in a method, and this parameter must be the last parameter. Any regular parameters must precede it.

Java treats a variable-length parameter as an array. You can pass an array or a variable number of arguments to a variable-length parameter. When invoking a method with a variable number of arguments, Java creates an array and passes the arguments to it. Listing 6.5 contains a method that prints the maximum value in a list of an unspecified number of values.

LISTING 6.5 VarArgsDemo.java

```
1 public class VarArgsDemo {
2     public static void main(String[] args) {
3         printMax(34, 3, 3, 2, 56.5);
4         printMax(new double[]{1, 2, 3});
5     }
6
7     public static void printMax(double... numbers) {
8         if (numbers.length == 0) {
9             System.out.println("No argument passed");

```

pass variable-length arg list
pass an array arg

a variable-length arg
parameter


```

10     return;
11 }
12
13     double result = numbers[0];
14
15     for (int i = 1; i < numbers.length; i++)
16         if (numbers[i] > result)
17             result = numbers[i];
18
19     System.out.println("The max value is " + result);
20 }
21 }

```

Line 3 invokes the `printMax` method with a variable-length argument list passed to the array `numbers`. If no arguments are passed, the length of the array is `0` (line 8).

Line 4 invokes the `printMax` method with an array.

6.17 What is wrong in the following method header?

```

public static void print(String... strings, double... numbers)
public static void print(double... numbers, String name)
public static double... print(double d1, double d2)

```



6.18 Can you invoke the `printMax` method in Listing 6.5 using the following statements?

```

printMax(1, 2, 2, 1, 4);
printMax(new double[]{1, 2, 3});
printMax(new int[]{1, 2, 3});

```

6.10 Searching Arrays

If an array is sorted, binary search is more efficient than linear search for finding an element in the array.



Searching is the process of looking for a specific element in an array—for example, discovering whether a certain score is included in a list of scores. Searching is a common task in computer programming. Many algorithms and data structures are devoted to searching. This section discusses two commonly used approaches, *linear search* and *binary search*.

linear search
binary search

6.10.1 The Linear Search Approach

The linear search approach compares the key element `key` sequentially with each element in the array. It continues to do so until the key matches an element in the array or the array is exhausted without a match being found. If a match is made, the linear search returns the index of the element in the array that matches the key. If no match is found, the search returns `-1`. The `linearSearch` method in Listing 6.6 gives the solution.



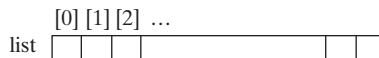
linear search animation on
Companion Website

LISTING 6.6 LinearSearch.java

```

1 public class LinearSearch {
2     /** The method for finding a key in the list */
3     public static int linearSearch(int[] list, int key) {
4         for (int i = 0; i < list.length; i++) {
5             if (key == list[i])
6                 return i;
7         }
8         return -1;
9     }
10 }

```



key Compare key with `list[i]` for `i = 0, 1, ...`

To better understand this method, trace it with the following statements:

```
1 int[] list = {1, 4, 4, 2, 5, -3, 6, 2};
2 int i = linearSearch(list, 4); // Returns 1
3 int j = linearSearch(list, -4); // Returns -1
4 int k = linearSearch(list, -3); // Returns 5
```

The linear search method compares the key with each element in the array. The elements can be in any order. On average, the algorithm will have to examine half of the elements in an array before finding the key, if it exists. Since the execution time of a linear search increases linearly as the number of array elements increases, linear search is inefficient for a large array.

6.10.2 The Binary Search Approach

Binary search is the other common search approach for a list of values. For binary search to work, the elements in the array must already be ordered. Assume that the array is in ascending order. The binary search first compares the key with the element in the middle of the array. Consider the following three cases:

- If the key is less than the middle element, you need to continue to search for the key only in the first half of the array.
- If the key is equal to the middle element, the search ends with a match.
- If the key is greater than the middle element, you need to continue to search for the key only in the second half of the array.

Clearly, the binary search method eliminates at least half of the array after each comparison. Sometimes you eliminate half of the elements, and sometimes you eliminate half plus one. Suppose that the array has n elements. For convenience, let n be a power of 2. After the first comparison, $n/2$ elements are left for further search; after the second comparison, $(n/2)/2$ elements are left. After the k th comparison, $n/2^k$ elements are left for further search. When $k = \log_2 n$, only one element is left in the array, and you need only one more comparison. Therefore, in the worst case when using the binary search approach, you need $\log_2 n + 1$ comparisons to find an element in the sorted array. In the worst case for a list of 1024 (2^{10}) elements, binary search requires only 11 comparisons, whereas a linear search requires 1023 comparisons in the worst case.



binary search animation on Companion Website

The portion of the array being searched shrinks by half after each comparison. Let **low** and **high** denote, respectively, the first index and last index of the array that is currently being searched. Initially, **low** is 0 and **high** is `list.length - 1`. Let **mid** denote the index of the middle element, so **mid** is $(\text{low} + \text{high})/2$. Figure 6.10 shows how to find key 11 in the list {2, 4, 7, 10, 11, 45, 50, 59, 60, 66, 69, 70, 79} using binary search.

You now know how the binary search works. The next task is to implement it in Java. Don't rush to give a complete implementation. Implement it incrementally, one step at a time. You may start with the first iteration of the search, as shown in Figure 6.11a. It compares the key with the middle element in the list whose **low** index is 0 and **high** index is `list.length - 1`. If `key < list[mid]`, set the **high** index to `mid - 1`; if `key == list[mid]`, a match is found and return **mid**; if `key > list[mid]`, set the **low** index to `mid + 1`.

Next consider implementing the method to perform the search repeatedly by adding a loop, as shown in Figure 6.11b. The search ends if the key is found, or if the key is not found when `low > high`.

When the key is not found, **low** is the insertion point where a key would be inserted to maintain the order of the list. It is more useful to return the insertion point than -1. The method must return a negative value to indicate that the key is not in the list. Can it simply return `-low`? No. If the key is less than `list[0]`, **low** would be 0. `-0` is 0. This would

why not -1?

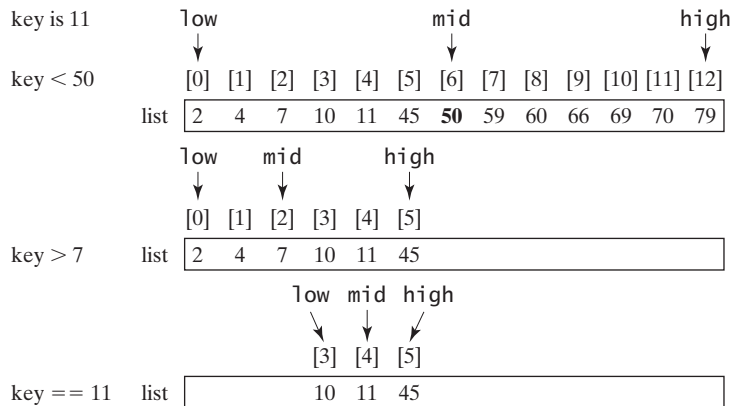


FIGURE 6.10 Binary search eliminates half of the list from further consideration after each comparison.

```
public static int binarySearch(
    int[] list, int key) {
    int low = 0;
    int high = list.length - 1;

    int mid = (low + high) / 2;
    if (key < list[mid])
        high = mid - 1;
    else if (key == list[mid])
        return mid;
    else
        low = mid + 1;
}
```

(a) Version 1

```
public static int binarySearch(
    int[] list, int key) {
    int low = 0;
    int high = list.length - 1;

    while (high >= low) {
        int mid = (low + high) / 2;
        if (key < list[mid])
            high = mid - 1;
        else if (key == list[mid])
            return mid;
        else
            low = mid + 1;
    }

    return -1; // Not found
}
```

(b) Version 2

FIGURE 6.11 Binary search is implemented incrementally.

indicate that the key matches `list[0]`. A good choice is to let the method return `-low - 1` if the key is not in the list. Returning `-low - 1` indicates not only that the key is not in the list, but also where the key would be inserted.

The complete program is given in Listing 6.7.

LISTING 6.7 BinarySearch.java

```
1 public class BinarySearch {
2     /** Use binary search to find the key in the list */
3     public static int binarySearch(int[] list, int key) {
4         int low = 0;
5         int high = list.length - 1;
6
7         while (high >= low) {
8             int mid = (low + high) / 2;
9             if (key < list[mid])
10                high = mid - 1;
11             else if (key == list[mid])
```

first half

```

12         return mid;
13     else
14         low = mid + 1;
15     }
16
17     return -low - 1; // Now high < low, key not found
18 }
19 }

```

second half

The binary search returns the index of the search key if it is contained in the list (line 12). Otherwise, it returns `-low - 1` (line 17).

What would happen if we replaced `(high >= low)` in line 7 with `(high > low)`? The search would miss a possible matching element. Consider a list with just one element. The search would miss the element.

Does the method still work if there are duplicate elements in the list? Yes, as long as the elements are sorted in increasing order. The method returns the index of one of the matching elements if the element is in the list.

To better understand this method, trace it with the following statements and identify `low` and `high` when the method returns.

```

int[] list = {2, 4, 7, 10, 11, 45, 50, 59, 60, 66, 69, 70, 79};
int i = BinarySearch.binarySearch(list, 2); // Returns 0
int j = BinarySearch.binarySearch(list, 11); // Returns 4
int k = BinarySearch.binarySearch(list, 12); // Returns -6
int l = BinarySearch.binarySearch(list, 1); // Returns -1
int m = BinarySearch.binarySearch(list, 3); // Returns -2

```

Here is the table that lists the `low` and `high` values when the method exits and the value returned from invoking the method.

Method	Low	High	Value Returned
<code>binarySearch(list, 2)</code>	0	1	0
<code>binarySearch(list, 11)</code>	3	5	4
<code>binarySearch(list, 12)</code>	5	4	-6
<code>binarySearch(list, 1)</code>	0	-1	-1
<code>binarySearch(list, 3)</code>	1	0	-2



Note

Linear search is useful for finding an element in a small array or an unsorted array, but it is inefficient for large arrays. Binary search is more efficient, but it requires that the array be presorted.

binary search benefits



Key
Point

6.11 Sorting Arrays

There are many strategies for sorting elements in an array. Selection sort and insertion sort are two common approaches.

selection sort
insertion sort

Sorting, like searching, is a common task in computer programming. Many different algorithms have been developed for sorting. This section introduces two simple, intuitive sorting algorithms: *selection sort* and *insertion sort*.

6.11.1 Selection Sort

Suppose that you want to sort a list in ascending order. Selection sort finds the smallest number in the list and swaps it with the first element. It then finds the smallest number remaining and swaps it with the second element, and so on, until only a single number remains. Figure 6.12 shows how to sort the list {2, 9, 5, 4, 8, 1, 6} using selection sort.



VideoNote

Selection sort



selection sort animation on
Companion Website

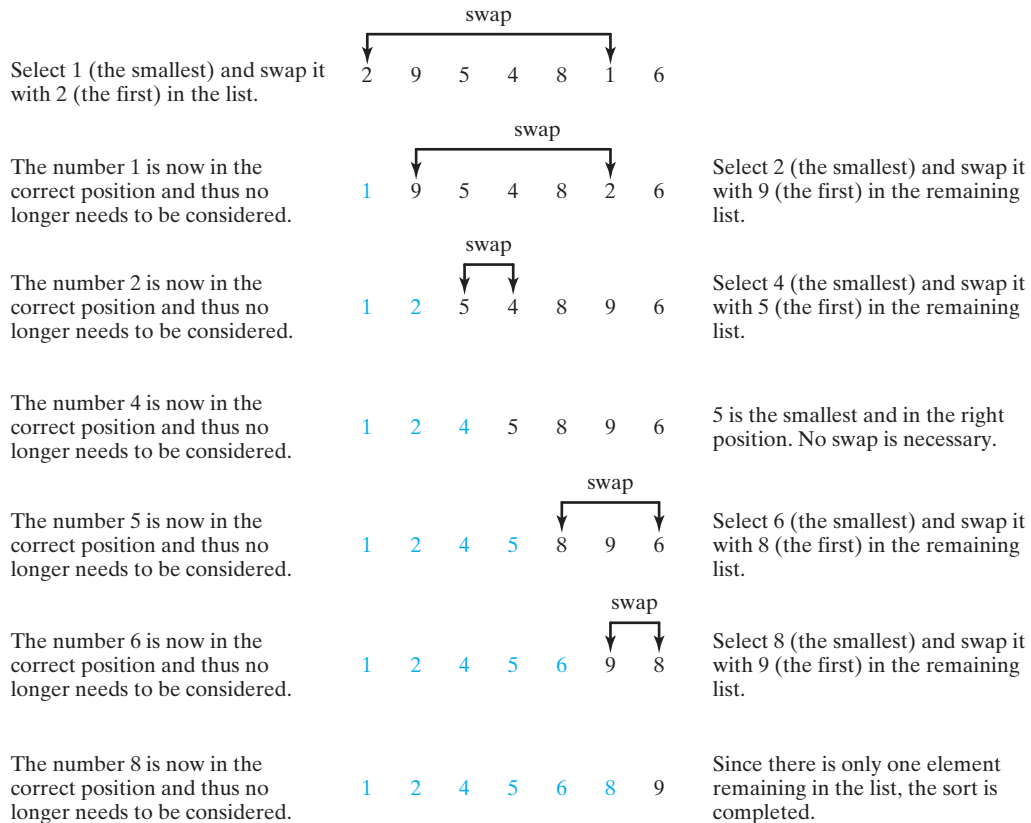


FIGURE 6.12 Selection sort repeatedly selects the smallest number and swaps it with the first number in the list.

You know how the selection-sort approach works. The task now is to implement it in Java. Beginners find it difficult to develop a complete solution on the first attempt. Start by writing the code for the first iteration to find the smallest element in the list and swap it with the first element, and then observe what would be different for the second iteration, the third, and so on. The insight this gives will enable you to write a loop that generalizes all the iterations.

The solution can be described as follows:

```
for (int i = 0; i < list.length - 1; i++) {
    select the smallest element in list[i..list.length-1];
    swap the smallest with list[i], if necessary;
    // list[i] is in its correct position.
    // The next iteration apply on list[i+1..list.length-1]
}
```

Listing 6.8 implements the solution.

LISTING 6.8 SelectionSort.java

```

1  public class SelectionSort {
2      /** The method for sorting the numbers */
3      public static void selectionSort(double[] list) {
4          for (int i = 0; i < list.length - 1; i++) {
5              // Find the minimum in the list[i..list.length-1]
6              double currentMin = list[i];
7              int currentMinIndex = i;
8
9              for (int j = i + 1; j < list.length; j++) {
10                 if (currentMin > list[j]) {
11                     currentMin = list[j];
12                     currentMinIndex = j;
13                 }
14             }
15
16             // Swap list[i] with list[currentMinIndex] if necessary
17             if (currentMinIndex != i) {
18                 list[currentMinIndex] = list[i];
19                 list[i] = currentMin;
20             }
21         }
22     }
23 }

```

select

swap

The `selectionSort(double[] list)` method sorts any array of `double` elements. The method is implemented with a nested `for` loop. The outer loop (with the loop control variable `i`) (line 4) is iterated in order to find the smallest element in the list, which ranges from `list[i]` to `list[list.length-1]`, and exchange it with `list[i]`.

The variable `i` is initially `0`. After each iteration of the outer loop, `list[i]` is in the right place. Eventually, all the elements are put in the right place; therefore, the whole list is sorted.

To understand this method better, trace it with the following statements:

```

double[] list = {1, 9, 4.5, 6.6, 5.7, -4.5};
SelectionSort.selectionSort(list);

```

6.11.2 Insertion Sort

Suppose that you want to sort a list in ascending order. The insertion-sort algorithm sorts a list of values by repeatedly inserting a new element into a sorted sublist until the whole list is sorted. Figure 6.13 shows how to sort the list `{2, 9, 5, 4, 8, 1, 6}` using insertion sort.

The algorithm can be described as follows:

```

for (int i = 1; i < list.length; i++) {
    insert list[i] into a sorted sublist list[0..i-1] so that
    list[0..i] is sorted.
}

```

To insert `list[i]` into `list[0..i-1]`, save `list[i]` into a temporary variable, say `currentElement`. Move `list[i-1]` to `list[i]` if `list[i-1] > currentElement`, move `list[i-2]` to `list[i-1]` if `list[i-2] > currentElement`, and so on, until `list[i-k] <= currentElement` or `k > i` (we pass the first element of the sorted list). Assign `currentElement` to `list[i-k+1]`. For example, to insert `4` into `{2, 5, 9}` in Step 4 in Figure 6.14, move `list[2]` (`9`) to `list[3]` since `9 > 4`, and move `list[1]` (`5`) to `list[2]` since `5 > 4`. Finally, move `currentElement` (`4`) to `list[1]`.



insertion sort animation on
Companion Website

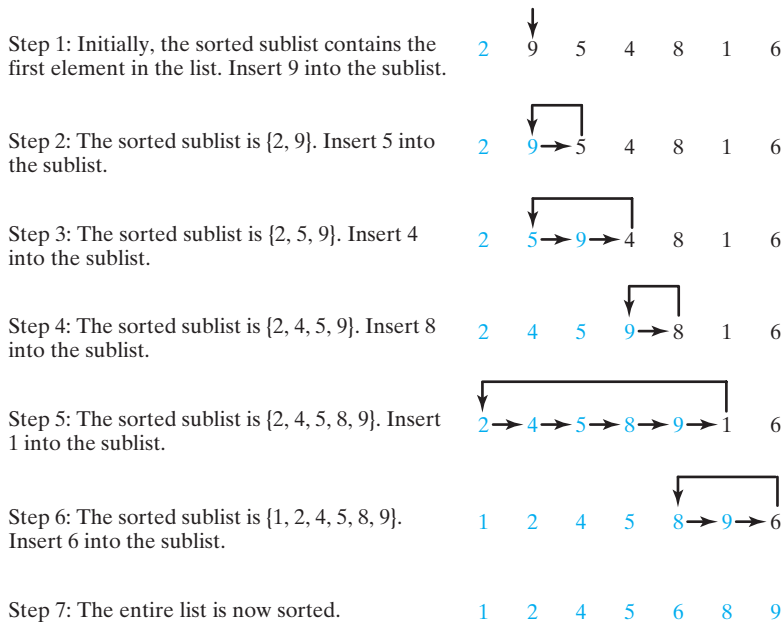


FIGURE 6.13 Insertion sort repeatedly inserts a new element into a sorted sublist.

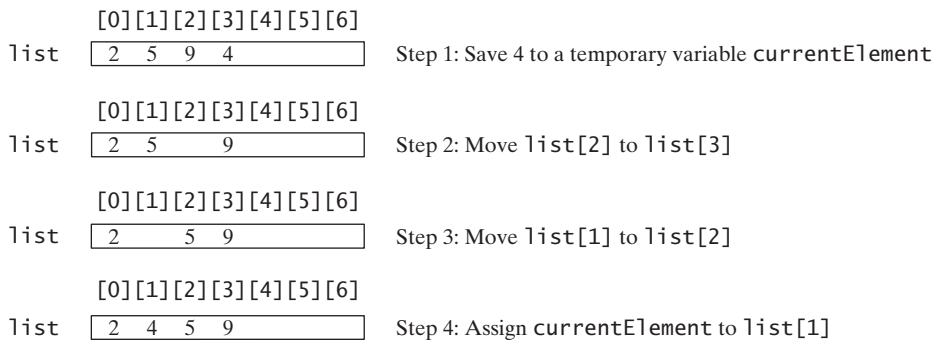


FIGURE 6.14 A new element is inserted into a sorted sublist.

The algorithm can be expanded and implemented as in Listing 6.9.

LISTING 6.9 InsertionSort.java

```

1 public class InsertionSort {
2     /** The method for sorting the numbers */
3     public static void insertionSort(double[] list) {
4         for (int i = 1; i < list.length; i++) {
5             /** Insert list[i] into a sorted sublist list[0..i-1] so that
6                 list[0..i] is sorted. */
7             double currentElement = list[i];
8             int k;
9             for (k = i - 1; k >= 0 && list[k] > currentElement; k--) {
10                list[k + 1] = list[k];
11            }
12
13            // Insert the current element into list[k + 1]

```

```

insert      14         list[k + 1] = currentElement;
            15     }
            16     }
            17 }

```

The `insertionSort(double[] list)` method sorts any array of `double` elements. The method is implemented with a nested `for` loop. The outer loop (with the loop control variable `i`) (line 4) is iterated in order to obtain a sorted sublist, which ranges from `list[0]` to `list[i]`. The inner loop (with the loop control variable `k`) inserts `list[i]` into the sublist from `list[0]` to `list[i-1]`.

To better understand this method, trace it with the following statements:

```

double[] list = {1, 9, 4.5, 6.6, 5.7, -4.5};
InsertionSort.insertionSort(list);

```



MyProgrammingLab™

- 6.19** Use Figure 6.10 as an example to show how to apply the binary search approach to a search for key `10` and key `12` in list `{2, 4, 7, 10, 11, 45, 50, 59, 60, 66, 69, 70, 79}`.
- 6.20** If the binary search method returns `-4`, is the key in the list? Where should the key be inserted if you wish to insert the key into the list?
- 6.21** Use Figure 6.12 as an example to show how to apply the selection-sort approach to sort `{3.4, 5, 3, 3.5, 2.2, 1.9, 2}`.
- 6.22** Use Figure 6.13 as an example to show how to apply the insertion-sort approach to sort `{3.4, 5, 3, 3.5, 2.2, 1.9, 2}`.
- 6.23** How do you modify the `selectionSort` method in Listing 6.8 to sort numbers in decreasing order?
- 6.24** How do you modify the `insertionSort` method in Listing 6.9 to sort numbers in decreasing order?

6.12 The Arrays Class



The `java.util.Arrays` class contains useful methods for common array operations such as sorting and searching.

The `java.util.Arrays` class contains various static methods for sorting and searching arrays, comparing arrays, filling array elements, and returning a string representation of the array. These methods are overloaded for all primitive types.

sort You can use the `sort` method to sort a whole array or a partial array. For example, the following code sorts an array of numbers and an array of characters.

```

double[] numbers = {6.0, 4.4, 1.9, 2.9, 3.4, 3.5};
java.util.Arrays.sort(numbers); // Sort the whole array

char[] chars = {'a', 'A', '4', 'F', 'D', 'P'};
java.util.Arrays.sort(chars, 1, 3); // Sort part of the array

```

Invoking `sort(numbers)` sorts the whole array `numbers`. Invoking `sort(chars, 1, 3)` sorts a partial array from `chars[1]` to `chars[3-1]`.

binarySearch You can use the `binarySearch` method to search for a key in an array. The array must be pre-sorted in increasing order. If the key is not in the array, the method returns `-(insertionIndex + 1)`. For example, the following code searches the keys in an array of integers and an array of characters.

```

int[] list = {2, 4, 7, 10, 11, 45, 50, 59, 60, 66, 69, 70, 79};
System.out.println("(1) Index is " +
    java.util.Arrays.binarySearch(list, 11));

```



```

System.out.println("(2) Index is " +
    java.util.Arrays.binarySearch(list, 12));

char[] chars = {'a', 'c', 'g', 'x', 'y', 'z'};
System.out.println("(3) Index is " +
    java.util.Arrays.binarySearch(chars, 'a'));
System.out.println("(4) Index is " +
    java.util.Arrays.binarySearch(chars, 't'));

```

The output of the preceding code is

1. Index is 4
2. Index is -6
3. Index is 0
4. Index is -4

You can use the `equals` method to check whether two arrays are equal. Two arrays are equal if they have the same contents. In the following code, `list1` and `list2` are equal, but `list2` and `list3` are not.

```

int[] list1 = {2, 4, 7, 10};
int[] list2 = {2, 4, 7, 10};
int[] list3 = {4, 2, 7, 10};
System.out.println(java.util.Arrays.equals(list1, list2)); // true
System.out.println(java.util.Arrays.equals(list2, list3)); // false

```

You can use the `fill` method to fill in all or part of the array. For example, the following code fills `list1` with 5 and fills 8 into elements `list2[1]` and `list2[3-1]`.

```

int[] list1 = {2, 4, 7, 10};
int[] list2 = {2, 4, 7, 10};
java.util.Arrays.fill(list1, 5); // Fill 5 to the whole array
java.util.Arrays.fill(list2, 1, 3, 8); // Fill 8 to a partial array

```

You can also use the `toString` method to return a string that represents all elements in the array. This is a quick and simple way to display all elements in the array. For example, the following code

```

int[] list = {2, 4, 7, 10};
System.out.println(Arrays.toString(list));

```

displays `[2, 4, 7, 10]`.

- 6.25** What types of array can be sorted using the `java.util.Arrays.sort` method? Does this `sort` method create a new array?
- 6.26** To apply `java.util.Arrays.binarySearch(array, key)`, should the array be sorted in increasing order, in decreasing order, or neither?
- 6.27** Show the output of the following code:

```

int[] list1 = {2, 4, 7, 10};
java.util.Arrays.fill(list1, 7);
System.out.println(java.util.Arrays.toString(list1));

int[] list2 = {2, 4, 7, 10};
System.out.println(java.util.Arrays.toString(list2));
System.out.print(java.util.Arrays.equals(list1, list2));

```



KEY TERMS

anonymous array	238	indexed variable	226
array	224	insertion sort	248
array initializer	227	linear search	245
binary search	245	off-by-one error	230
garbage collection	236	selection sort	248
index	224		

CHAPTER SUMMARY

1. A variable is declared as an *array* type using the syntax `elementType[] arrayRefVar` or `elementType arrayRefVar[]`. The style `elementType[] arrayRefVar` is preferred, although `elementType arrayRefVar[]` is legal.
2. Unlike declarations for primitive data type variables, the declaration of an array variable does not allocate any space in memory for the array. An array variable is not a primitive data type variable. An array variable contains a reference to an array.
3. You cannot assign elements to an array unless it has already been created. You can create an array by using the `new` operator with the following syntax: `new elementType[arraySize]`.
4. Each element in the array is represented using the syntax `arrayRefVar[index]`. An *index* must be an integer or an integer expression.
5. After an array is created, its size becomes permanent and can be obtained using `arrayRefVar.length`. Since the index of an array always begins with `0`, the last index is always `arrayRefVar.length - 1`. An out-of-bounds error will occur if you attempt to reference elements beyond the bounds of an array.
6. Programmers often mistakenly reference the first element in an array with index `1`, but it should be `0`. This is called the *index off-by-one error*.
7. When an array is created, its elements are assigned the default value of `0` for the numeric primitive data types, `\u0000` for char types, and `false` for `boolean` types.
8. Java has a shorthand notation, known as the *array initializer*, which combines declaring an array, creating an array, and initializing an array in one statement, using the syntax `elementType[] arrayRefVar = {value0, value1, ..., valuek}`.
9. When you pass an array argument to a method, you are actually passing the reference of the array; that is, the called method can modify the elements in the caller's original array.
10. If an array is sorted, *binary search* is more efficient than *linear search* for finding an element in the array.
11. *Selection sort* finds the smallest number in the list and swaps it with the first element. It then finds the smallest number remaining and swaps it with the first element in the remaining list, and so on, until only a single number remains.

12. The *insertion-sort algorithm* sorts a list of values by repeatedly inserting a new element into a sorted sublist until the whole list is sorted.

TEST QUESTIONS

Do the test questions for this chapter online at www.cs.armstrong.edu/liang/intro9e/test.html.

PROGRAMMING EXERCISES

MyProgrammingLab™

Sections 6.2–6.5

- *6.1** (*Assign grades*) Write a program that reads student scores, gets the best score, and then assigns grades based on the following scheme:

Grade is A if score is \geq best - 10

Grade is B if score is \geq best - 20;

Grade is C if score is \geq best - 30;

Grade is D if score is \geq best - 40;

Grade is F otherwise.

The program prompts the user to enter the total number of students, then prompts the user to enter all of the scores, and concludes by displaying the grades. Here is a sample run:

```
Enter the number of students: 4 ↵ Enter
Enter 4 scores: 40 55 70 58 ↵ Enter
Student 0 score is 40 and grade is C
Student 1 score is 55 and grade is B
Student 2 score is 70 and grade is A
Student 3 score is 58 and grade is B
```



- 6.2** (*Reverse the numbers entered*) Write a program that reads ten integers and displays them in the reverse of the order in which they were read.

- **6.3** (*Count occurrence of numbers*) Write a program that reads the integers between 1 and 100 and counts the occurrences of each. Assume the input ends with 0. Here is a sample run of the program:

```
Enter the integers between 1 and 100: 2 5 6 5 4 3 23 43 2 0 ↵ Enter
2 occurs 2 times
3 occurs 1 time
4 occurs 1 time
5 occurs 2 times
6 occurs 1 time
23 occurs 1 time
43 occurs 1 time
```



Note that if a number occurs more than one time, the plural word “times” is used in the output.

- 6.4** (*Analyze scores*) Write a program that reads an unspecified number of scores and determines how many scores are above or equal to the average and how many scores are below the average. Enter a negative number to signify the end of the input. Assume that the maximum number of scores is 100.
- **6.5** (*Print distinct numbers*) Write a program that reads in ten numbers and displays distinct numbers (i.e., if a number appears multiple times, it is displayed only once). (*Hint*: Read a number and store it to an array if it is new. If the number is already in the array, ignore it.) After the input, the array contains the distinct numbers. Here is the sample run of the program:



```
Enter ten numbers: 1 2 3 2 1 6 3 4 5 2 ↵ Enter
The distinct numbers are: 1 2 3 6 4 5
```

- *6.6** (*Revise Listing 4.14, PrimeNumber.java*) Listing 4.14 determines whether a number n is prime by checking whether $2, 3, 4, 5, 6, \dots, n/2$ is a divisor. If a divisor is found, n is not prime. A more efficient approach is to check whether any of the prime numbers less than or equal to \sqrt{n} can divide n evenly. If not, n is prime. Rewrite Listing 4.14 to display the first 50 prime numbers using this approach. You need to use an array to store the prime numbers and later use them to check whether they are possible divisors for n .
- *6.7** (*Count single digits*) Write a program that generates 100 random integers between 0 and 9 and displays the count for each number. (*Hint*: Use `(int)(Math.random() * 10)` to generate a random integer between 0 and 9. Use an array of ten integers, say `counts`, to store the counts for the number of 0s, 1s, ..., 9s.)

Sections 6.6–6.8

- 6.8** (*Average an array*) Write two overloaded methods that return the average of an array with the following headers:

```
public static int average(int[] array)
public static double average(double[] array)
```

Write a test program that prompts the user to enter ten double values, invokes this method, and displays the average value.

- 6.9** (*Find the smallest element*) Write a method that finds the smallest element in an array of double values using the following header:

```
public static double min(double[] array)
```

Write a test program that prompts the user to enter ten numbers, invokes this method to return the minimum value, and displays the minimum value. Here is a sample run of the program:



```
Enter ten numbers: 1.9 2.5 3.7 2 1.5 6 3 4 5 2 ↵ Enter
The minimum number is: 1.5
```

- 6.10** (*Find the index of the smallest element*) Write a method that returns the index of the smallest element in an array of integers. If the number of such elements is greater than 1, return the smallest index. Use the following header:

```
public static int indexOfSmallestElement(double[] array)
```

Write a test program that prompts the user to enter ten numbers, invokes this method to return the index of the smallest element, and displays the index.

- *6.11** (*Statistics: compute deviation*) Programming Exercise 5.37 computes the standard deviation of numbers. This exercise uses a different but equivalent formula to compute the standard deviation of n numbers.

$$\text{mean} = \frac{\sum_{i=1}^n x_i}{n} = \frac{x_1 + x_2 + \dots + x_n}{n} \quad \text{deviation} = \sqrt{\frac{\sum_{i=1}^n (x_i - \text{mean})^2}{n - 1}}$$

To compute the standard deviation with this formula, you have to store the individual numbers using an array, so that they can be used after the mean is obtained.

Your program should contain the following methods:

```
/** Compute the deviation of double values */
public static double deviation(double[] x)

/** Compute the mean of an array of double values */
public static double mean(double[] x)
```

Write a test program that prompts the user to enter ten numbers and displays the mean and standard deviation, as shown in the following sample run:

```
Enter ten numbers: 1.9 2.5 3.7 2 1 6 3 4 5 2 
The mean is 3.11
The standard deviation is 1.55738
```



- *6.12** (*Reverse an array*) The **reverse** method in Section 6.7 reverses an array by copying it to a new array. Rewrite the method that reverses the array passed in the argument and returns this array. Write a test program that prompts the user to enter ten numbers, invokes the method to reverse the numbers, and displays the numbers.

Section 6.9

- *6.13** (*Random number chooser*) Write a method that returns a random number between 1 and 54, excluding the numbers passed in the argument. The method header is specified as follows:

```
public static int getRandom(int... numbers)
```

- 6.14** (*Computing gcd*) Write a method that returns the gcd of an unspecified number of integers. The method header is specified as follows:

```
public static int gcd(int... numbers)
```

Write a test program that prompts the user to enter five numbers, invokes the method to find the gcd of these numbers, and displays the gcd.

Sections 6.10–6.12

- 6.15** (*Eliminate duplicates*) Write a method that returns a new array by eliminating the duplicate values in the array using the following method header:

```
public static int[] eliminateDuplicates(int[] list)
```

Write a test program that reads in ten integers, invokes the method, and displays the result. Here is the sample run of the program:



```
Enter ten numbers: 1 2 3 2 1 6 3 4 5 2 ↵ Enter
The distinct numbers are: 1 2 3 6 4 5
```

6.16 (*Execution time*) Write a program that randomly generates an array of 100,000 integers and a key. Estimate the execution time of invoking the `LinearSearch` method in Listing 6.6. Sort the array and estimate the execution time of invoking the `BinarySearch` method in Listing 6.7. You can use the following code template to obtain the execution time:

```
long startTime = System.currentTimeMillis();
perform the task;
long endTime = System.currentTimeMillis();
long executionTime = endTime - startTime;
```

****6.17** (*Sort students*) Write a program that prompts the user to enter the number of students, the students' names, and their scores, and prints student names in decreasing order of their scores.

****6.18** (*Bubble sort*) Write a sort method that uses the bubble-sort algorithm. The bubble-sort algorithm makes several passes through the array. On each pass, successive neighboring pairs are compared. If a pair is not in order, its values are swapped; otherwise, the values remain unchanged. The technique is called a *bubble sort* or *sinking sort* because the smaller values gradually “bubble” their way to the top and the larger values “sink” to the bottom. Write a test program that reads in ten double numbers, invokes the method, and displays the sorted numbers.

****6.19** (*Sorted?*) Write the following method that returns true if the list is already sorted in increasing order.

```
public static boolean isSorted(int[] list)
```

Write a test program that prompts the user to enter a list and displays whether the list is sorted or not. Here is a sample run. Note that the first number in the input indicates the number of the elements in the list.



```
Enter list: 8 10 1 5 16 61 9 11 1 ↵ Enter
The list is not sorted
```



```
Enter list: 10 1 1 3 4 4 5 7 9 11 21 ↵ Enter
The list is already sorted
```

***6.20** (*Revise selection sort*) In Section 6.11.1, you used selection sort to sort an array. The selection-sort method repeatedly finds the smallest number in the current array and swaps it with the first. Rewrite this program by finding the largest number and swapping it with the last. Write a test program that reads in ten double numbers, invokes the method, and displays the sorted numbers.

*****6.21** (*Game: bean machine*) The bean machine, also known as a quincunx or the Galton box, is a device for statistics experiments named after English scientist Sir Francis Galton. It consists of an upright board with evenly spaced nails (or pegs) in a triangular form, as shown in Figure 6.15.

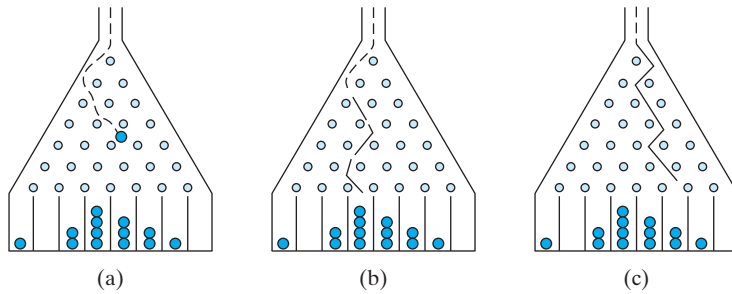


FIGURE 6.15 Each ball takes a random path and falls into a slot.

Balls are dropped from the opening of the board. Every time a ball hits a nail, it has a 50% chance of falling to the left or to the right. The piles of balls are accumulated in the slots at the bottom of the board.

Write a program that simulates the bean machine. Your program should prompt the user to enter the number of the balls and the number of the slots in the machine. Simulate the falling of each ball by printing its path. For example, the path for the ball in Figure 6.15b is LLRLLR and the path for the ball in Figure 6.15c is RLRLLR. Display the final buildup of the balls in the slots in a histogram. Here is a sample run of the program:

```

Enter the number of balls to drop: 5 
Enter the number of slots in the bean machine: 7 

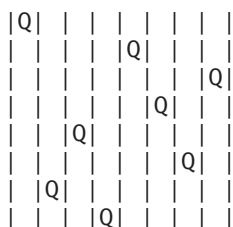
LRLRRLR
RRLLLLR
LLRLLLR
RRLLLL
LRLRRLR

  0
  0
 000
    
```



(Hint: Create an array named `slots`. Each element in `slots` stores the number of balls in a slot. Each ball falls into a slot via a path. The number of Rs in a path is the position of the slot where the ball falls. For example, for the path LRLRRLR, the ball falls into `slots[4]`, and for the path is RRLLLL, the ball falls into `slots[2]`.)

*****6.22** (Game: Eight Queens) The classic Eight Queens puzzle is to place eight queens on a chessboard such that no two queens can attack each other (i.e., no two queens are on the same row, same column, or same diagonal). There are many possible solutions. Write a program that displays one such solution. A sample output is shown below:



- **6.23** (*Game: locker puzzle*) A school has 100 lockers and 100 students. All lockers are closed on the first day of school. As the students enter, the first student, denoted S1, opens every locker. Then the second student, S2, begins with the second locker, denoted L2, and closes every other locker. Student S3 begins with the third locker and changes every third locker (closes it if it was open, and opens it if it was closed). Student S4 begins with locker L4 and changes every fourth locker. Student S5 starts with L5 and changes every fifth locker, and so on, until student S100 changes L100.

After all the students have passed through the building and changed the lockers, which lockers are open? Write a program to find your answer.

(*Hint:* Use an array of 100 Boolean elements, each of which indicates whether a locker is open (**true**) or closed (**false**). Initially, all lockers are closed.)

- **6.24** (*Simulation: coupon collector's problem*) Coupon collector is a classic statistics problem with many practical applications. The problem is to pick objects from a set of objects repeatedly and find out how many picks are needed for all the objects to be picked at least once. A variation of the problem is to pick cards from a shuffled deck of 52 cards repeatedly and find out how many picks are needed before you see one of each suit. Assume a picked card is placed back in the deck before picking another. Write a program to simulate the number of picks needed to get four cards from each suit and display the four cards picked (it is possible a card may be picked twice). Here is a sample run of the program:



VideoNote

Coupon collector's problem



```
Queen of Spades
5 of Clubs
Queen of Hearts
4 of Diamonds
Number of picks: 12
```

- 6.25** (*Algebra: solve quadratic equations*) Write a method for solving a quadratic equation using the following header:

```
public static int solveQuadratic(double[] eqn, double[] roots)
```

The coefficients of a quadratic equation $ax^2 + bx + c = 0$ are passed to the array **eqn** and the noncomplex roots are stored in **roots**. The method returns the number of roots. See Programming Exercise 3.1 on how to solve a quadratic equation.

Write a program that prompts the user to enter values for *a*, *b*, and *c* and displays the number of roots and all noncomplex roots.

- 6.26** (*Strictly identical arrays*) The arrays **list1** and **list2** are *strictly identical* if their corresponding elements are equal. Write a method that returns **true** if **list1** and **list2** are strictly identical, using the following header:

```
public static boolean equals(int[] list1, int[] list2)
```

Write a test program that prompts the user to enter two lists of integers and displays whether the two are strictly identical. Here are the sample runs. Note that the first number in the input indicates the number of the elements in the list.



```
Enter list1: 5 2 5 6 1 6 -- Enter
Enter list2: 5 2 5 6 1 6 -- Enter
Two lists are strictly identical
```



```
Enter list1: 5 2 5 6 6 1 ↵ Enter
Enter list2: 5 2 5 6 1 6 ↵ Enter
Two lists are not strictly identical
```



- 6.27** (*Identical arrays*) The arrays `list1` and `list2` are *identical* if they have the same contents. Write a method that returns `true` if `list1` and `list2` are identical, using the following header:

```
public static boolean equals(int[] list1, int[] list2)
```

Write a test program that prompts the user to enter two lists of integers and displays whether the two are identical. Here are the sample runs. Note that the first number in the input indicates the number of the elements in the list.

```
Enter list1: 5 2 5 6 6 1 ↵ Enter
Enter list2: 5 2 5 6 1 6 ↵ Enter
Two lists are identical
```



```
Enter list1: 5 5 5 6 6 1 ↵ Enter
Enter list2: 5 2 5 6 1 6 ↵ Enter
Two lists are not identical
```



- *6.28** (*Math: combinations*) Write a program that prompts the user to enter 10 integers and displays all combinations of picking two numbers from the 10.
- *6.29** (*Game: pick four cards*) Write a program that picks four cards from a deck of 52 cards and computes their sum. An Ace, King, Queen, and Jack represent 1, 13, 12, and 11, respectively. Your program should display the number of picks that yields the sum of 24.
- *6.30** (*Pattern recognition: consecutive four equal numbers*) Write the following method that tests whether the array has four consecutive numbers with the same value.

```
public static boolean isConsecutiveFour(int[] values)
```

Write a test program that prompts the user to enter a series of integers and displays true if the series contains four consecutive numbers with the same value. Otherwise, display false. Your program should first prompt the user to enter the input size—i.e., the number of values in the series.

- **6.31** (*Merge two sorted lists*) Write the following method that merges two sorted lists into a new sorted list.

```
public static int[] merge(int[] list1, int[] list2)
```

Implement the method in a way that takes `list1.length + list2.length` comparisons. Write a test program that prompts the user to enter two sorted lists and displays the merged list. Here is a sample run. Note that the first number in the input indicates the number of the elements in the list.



VideoNote

Consecutive four



```
Enter list1: 5 1 5 16 61 111 ↵ Enter
Enter list2: 4 2 4 5 6 ↵ Enter
The merged list is 1 2 4 5 5 6 16 61 111
```

- **6.32** (*Partition of a list*) Write the following method that partitions the list using the first element, called a *pivot*.

```
public static int partition(int[] list)
```

After the partition, the elements in the list are rearranged so that all the elements before the pivot are less than or equal to the pivot and the elements after the pivot are greater than the pivot. The method returns the index where the pivot is located in the new list. For example, suppose the list is {5, 2, 9, 3, 6, 8}. After the partition, the list becomes {3, 2, 5, 9, 6, 8}. Implement the method in a way that takes `list.length` comparisons. Write a test program that prompts the user to enter a list and displays the list after the partition. Here is a sample run. Note that the first number in the input indicates the number of the elements in the list.



```
Enter list: 8 10 1 5 16 61 9 11 1 ↵ Enter
After the partition, the list is 9 1 5 1 10 61 11 16
```

- *6.33** (*Culture: Chinese Zodiac*) Simplify Listing 3.10 using an array of strings to store the animal names.
- ***6.34** (*Game: multiple Eight Queens solutions*) Exercise 6.22 finds one solution for the Eight Queens problem. Write a program to count all possible solutions for the Eight Queens problem and display all solutions.

MULTIDIMENSIONAL ARRAYS

Objectives

- To give examples of representing data using two-dimensional arrays (§7.1).
- To declare variables for two-dimensional arrays, create arrays, and access array elements in a two-dimensional array using row and column indexes (§7.2).
- To program common operations for two-dimensional arrays (displaying arrays, summing all elements, finding the minimum and maximum elements, and random shuffling) (§7.3).
- To pass two-dimensional arrays to methods (§7.4).
- To write a program for grading multiple-choice questions using two-dimensional arrays (§7.5).
- To solve the closest-pair problem using two-dimensional arrays (§7.6).
- To check a Sudoku solution using two-dimensional arrays (§7.7).
- To use multidimensional arrays (§7.8).



7.1 Introduction



Data in a table or a matrix can be represented using a two-dimensional array.

The preceding chapter introduced how to use one-dimensional arrays to store linear collections of elements. You can use a two-dimensional array to store a matrix or a table. For example, the following table that lists the distances between cities can be stored using a two-dimensional array named `distances`.

problem

Distance Table (in miles)							
	Chicago	Boston	New York	Atlanta	Miami	Dallas	Houston
Chicago	0	983	787	714	1375	967	1087
Boston	983	0	214	1102	1763	1723	1842
New York	787	214	0	888	1549	1548	1627
Atlanta	714	1102	888	0	661	781	810
Miami	1375	1763	1549	661	0	1426	1187
Dallas	967	1723	1548	781	1426	0	239
Houston	1087	1842	1627	810	1187	239	0

```
double[][] distances = {
    {0, 983, 787, 714, 1375, 967, 1087},
    {983, 0, 214, 1102, 1763, 1723, 1842},
    {787, 214, 0, 888, 1549, 1548, 1627},
    {714, 1102, 888, 0, 661, 781, 810},
    {1375, 1763, 1549, 661, 0, 1426, 1187},
    {967, 1723, 1548, 781, 1426, 0, 239},
    {1087, 1842, 1627, 810, 1187, 239, 0},
};
```

7.2 Two-Dimensional Array Basics



An element in a two-dimensional array is accessed through a row and column index.

How do you declare a variable for two-dimensional arrays? How do you create a two-dimensional array? How do you access elements in a two-dimensional array? This section addresses these issues.

7.2.1 Declaring Variables of Two-Dimensional Arrays and Creating Two-Dimensional Arrays

The syntax for declaring a two-dimensional array is:

```
elementType[][] arrayRefVar;
```

or

```
elementType arrayRefVar[][]; // Allowed, but not preferred
```

As an example, here is how you would declare a two-dimensional array variable `matrix` of `int` values:

```
int[][] matrix;
```

or

```
int matrix[][]; // This style is allowed, but not preferred
```

You can create a two-dimensional array of 5-by-5 **int** values and assign it to **matrix** using this syntax:

```
matrix = new int[5][5];
```

Two subscripts are used in a two-dimensional array, one for the row and the other for the column. As in a one-dimensional array, the index for each subscript is of the **int** type and starts from **0**, as shown in Figure 7.1a.

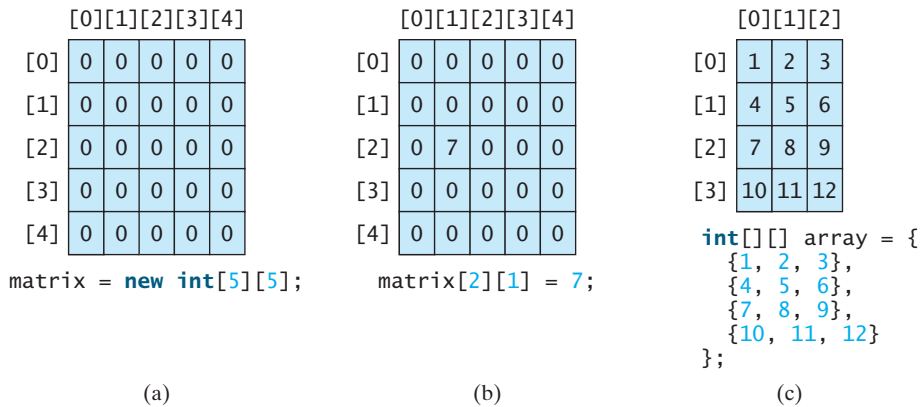


FIGURE 7.1 The index of each subscript of a two-dimensional array is an **int** value, starting from **0**.

To assign the value **7** to a specific element at row **2** and column **1**, as shown in Figure 7.1b, you can use the following syntax:

```
matrix[2][1] = 7;
```



Caution

It is a common mistake to use **matrix[2, 1]** to access the element at row **2** and column **1**. In Java, each subscript must be enclosed in a pair of square brackets.

You can also use an array initializer to declare, create, and initialize a two-dimensional array. For example, the following code in (a) creates an array with the specified initial values, as shown in Figure 7.1c. This is equivalent to the code in (b).

<pre>int[][] array = { {1, 2, 3}, {4, 5, 6}, {7, 8, 9}, {10, 11, 12} };</pre> <p>(a)</p>	<p>Equivalent</p> <hr style="border: 0; border-top: 1px solid black; width: 50%; margin: 0 auto;"/>	<pre>int[][] array = new int[4][3]; array[0][0] = 1; array[0][1] = 2; array[0][2] = 3; array[1][0] = 4; array[1][1] = 5; array[1][2] = 6; array[2][0] = 7; array[2][1] = 8; array[2][2] = 9; array[3][0] = 10; array[3][1] = 11; array[3][2] = 12;</pre> <p>(b)</p>
---	---	---

7.2.2 Obtaining the Lengths of Two-Dimensional Arrays

A two-dimensional array is actually an array in which each element is a one-dimensional array. The length of an array **x** is the number of elements in the array, which can be obtained using **x.length**. **x[0]**, **x[1]**, . . . , and **x[x.length-1]** are arrays. Their lengths can be obtained using **x[0].length**, **x[1].length**, . . . , and **x[x.length-1].length**.

For example, suppose `x = new int[3][4]`, `x[0]`, `x[1]`, and `x[2]` are one-dimensional arrays and each contains four elements, as shown in Figure 7.2. `x.length` is 3, and `x[0].length`, `x[1].length`, and `x[2].length` are 4.

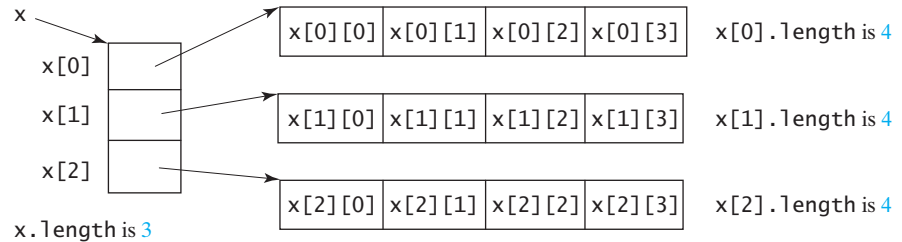
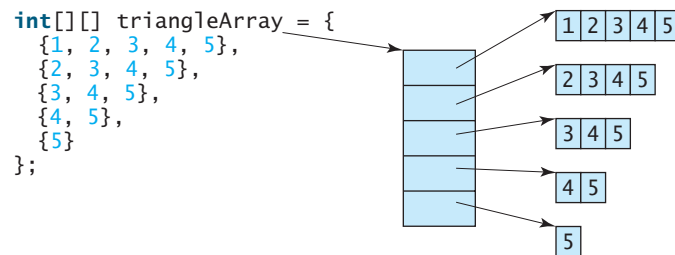


FIGURE 7.2 A two-dimensional array is a one-dimensional array in which each element is another one-dimensional array.

7.2.3 Ragged Arrays

Each row in a two-dimensional array is itself an array. Thus, the rows can have different lengths. An array of this kind is known as a *ragged array*. Here is an example of creating a ragged array:

ragged array



As you can see, `triangleArray[0].length` is 5, `triangleArray[1].length` is 4, `triangleArray[2].length` is 3, `triangleArray[3].length` is 2, and `triangleArray[4].length` is 1.

If you don't know the values in a ragged array in advance, but do know the sizes—say, the same as before—you can create a ragged array using the following syntax:

```
int[][] triangleArray = new int[5][];
triangleArray[0] = new int[5];
triangleArray[1] = new int[4];
triangleArray[2] = new int[3];
triangleArray[3] = new int[2];
triangleArray[4] = new int[1];
```

You can now assign values to the array. For example,

```
triangleArray[0][3] = 50;
triangleArray[4][0] = 45;
```



Note

The syntax `new int[5][]` for creating an array requires the first index to be specified. The syntax `new int[][]` would be wrong.



7.1 Declare an array reference variable for a two-dimensional array of `int` values, create a 4-by-5 `int` matrix, and assign it to the variable.

7.2 Can the rows in a two-dimensional array have different lengths?

7.3 What is the output of the following code?

```
int[][] array = new int[5][6];
int[] x = {1, 2};
array[0] = x;
System.out.println("array[0][1] is " + array[0][1]);
```

7.4 Which of the following statements are valid?

```
int[][] r = new int[2];
int[] x = new int[];
int[][] y = new int[3][];
int[][] z = {{1, 2}};
int[][] m = {{1, 2}, {2, 3}};
int[][] n = {{1, 2}, {2, 3}, };
```

7.3 Processing Two-Dimensional Arrays

Nested for loops are often used to process a two-dimensional array.

Suppose an array **matrix** is created as follows:

```
int[][] matrix = new int[10][10];
```

The following are some examples of processing two-dimensional arrays.

1. *Initializing arrays with input values.* The following loop initializes the array with user input values:

```
java.util.Scanner input = new Scanner(System.in);
System.out.println("Enter " + matrix.length + " rows and " +
    matrix[0].length + " columns: ");
for (int row = 0; row < matrix.length; row++) {
    for (int column = 0; column < matrix[row].length; column++) {
        matrix[row][column] = input.nextInt();
    }
}
```

2. *Initializing arrays with random values.* The following loop initializes the array with random values between 0 and 99:

```
for (int row = 0; row < matrix.length; row++) {
    for (int column = 0; column < matrix[row].length; column++) {
        matrix[row][column] = (int)(Math.random() * 100);
    }
}
```

3. *Printing arrays.* To print a two-dimensional array, you have to print each element in the array using a loop like the following:

```
for (int row = 0; row < matrix.length; row++) {
    for (int column = 0; column < matrix[row].length; column++) {
        System.out.print(matrix[row][column] + " ");
    }
    System.out.println();
}
```



Key
Point

4. *Summing all elements.* Use a variable named **total** to store the sum. Initially **total** is 0. Add each element in the array to **total** using a loop like this:

```
int total = 0;
for (int row = 0; row < matrix.length; row++) {
    for (int column = 0; column < matrix[row].length; column++) {
        total += matrix[row][column];
    }
}
```

5. *Summing elements by column.* For each column, use a variable named **total** to store its sum. Add each element in the column to **total** using a loop like this:

```
for (int column = 0; column < matrix[0].length; column++) {
    int total = 0;
    for (int row = 0; row < matrix.length; row++)
        total += matrix[row][column];
    System.out.println("Sum for column " + column + " is "
        + total);
}
```

6. *Which row has the largest sum?* Use variables **maxRow** and **indexOfMaxRow** to track the largest sum and index of the row. For each row, compute its sum and update **maxRow** and **indexOfMaxRow** if the new sum is greater.

```
int maxRow = 0;
int indexOfMaxRow = 0;

// Get sum of the first row in maxRow
for (int column = 0; column < matrix[0].length; column++) {
    maxRow += matrix[0][column];
}

for (int row = 1; row < matrix.length; row++) {
    int totalOfThisRow = 0;
    for (int column = 0; column < matrix[row].length; column++)
        totalOfThisRow += matrix[row][column];

    if (totalOfThisRow > maxRow) {
        maxRow = totalOfThisRow;
        indexOfMaxRow = row;
    }
}

System.out.println("Row " + indexOfMaxRow
    + " has the maximum sum of " + maxRow);
```

7. *Random shuffling.* Shuffling the elements in a one-dimensional array was introduced in Section 6.2.6. How do you shuffle all the elements in a two-dimensional array? To accomplish this, for each element **matrix[i][j]**, randomly generate indices **i1** and **j1** and swap **matrix[i][j]** with **matrix[i1][j1]**, as follows:

```
for (int i = 0; i < matrix.length; i++) {
    for (int j = 0; j < matrix[i].length; j++) {
        int i1 = (int)(Math.random() * matrix.length);
        int j1 = (int)(Math.random() * matrix[i].length);

        // Swap matrix[i][j] with matrix[i1][j1]
        int temp = matrix[i][j];
        matrix[i][j] = matrix[i1][j1];
        matrix[i1][j1] = temp;
    }
}
```



VideoNote

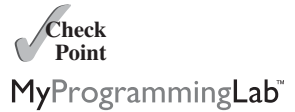
Find the row with the largest sum

7.5 Show the printout of the following code:

```
int[][] array = {{1, 2}, {3, 4}, {5, 6}};
for (int i = array.length - 1; i >= 0; i--) {
    for (int j = array[i].length - 1; j >= 0; j--)
        System.out.print(array[i][j] + " ");
    System.out.println();
}
```

7.6 Show the printout of the following code:

```
int[][] array = {{1, 2}, {3, 4}, {5, 6}};
int sum = 0;
for (int i = 0; i < array.length; i++)
    sum += array[i][0];
System.out.println(sum);
```



7.4 Passing Two-Dimensional Arrays to Methods

When passing a two-dimensional array to a method, the reference of the array is passed to the method.



You can pass a two-dimensional array to a method just as you pass a one-dimensional array. You can also return an array from a method. Listing 7.1 gives an example with two methods. The first method, `getArray()`, returns a two-dimensional array, and the second method, `sum(int[][] m)`, returns the sum of all the elements in a matrix.

LISTING 7.1 PassTwoDimensionalArray.java

```
1 import java.util.Scanner;
2
3 public class PassTwoDimensionalArray {
4     public static void main(String[] args) {
5         int[][] m = getArray(); // Get an array           get array
6
7         // Display sum of elements
8         System.out.println("\nSum of all elements is " + sum(m)); // pass array
9     }
10
11     public static int[][] getArray() {                   getArray method
12         // Create a Scanner
13         Scanner input = new Scanner(System.in);
14
15         // Enter array values
16         int[][] m = new int[3][4];
17         System.out.println("Enter " + m.length + " rows and "
18             + m[0].length + " columns: ");
19         for (int i = 0; i < m.length; i++)
20             for (int j = 0; j < m[i].length; j++)
21                 m[i][j] = input.nextInt();
22
23         return m; // return array
24     }
25
26     public static int sum(int[][] m) {                   sum method
27         int total = 0;
28         for (int row = 0; row < m.length; row++) {
29             for (int column = 0; column < m[row].length; column++) {
30                 total += m[row][column];
31             }

```

```

32     }
33
34     return total;
35 }
36 }

```



Enter 3 rows and 4 columns:

```

1 2 3 4 ↵ Enter
5 6 7 8 ↵ Enter
9 10 11 12 ↵ Enter

```

Sum of all elements is 78

The method `getArray` prompts the user to enter values for the array (lines 11–24) and returns the array (line 23).

The method `sum` (lines 26–35) has a two-dimensional array argument. You can obtain the number of rows using `m.length` (line 28) and the number of columns in a specified row using `m[row].length` (line 29).



MyProgrammingLab™

7.7 Show the printout of the following code:

```

public class Test {
    public static void main(String[] args) {
        int[][] array = {{1, 2, 3, 4}, {5, 6, 7, 8}};
        System.out.println(m1(array)[0]);
        System.out.println(m1(array)[1]);
    }

    public static int[] m1(int[][] m) {
        int[] result = new int[2];
        result[0] = m.length;
        result[1] = m[0].length;
        return result;
    }
}

```

7.5 Case Study: Grading a Multiple-Choice Test



The problem is to write a program that will grade multiple-choice tests.

Suppose you need to write a program that grades multiple-choice tests. Assume there are eight students and ten questions, and the answers are stored in a two-dimensional array. Each row records a student's answers to the questions, as shown in the following array.



VideoNote

Grade multiple-choice test

Students' Answers to the Questions:

0 1 2 3 4 5 6 7 8 9

Student 0	A	B	A	C	C	D	E	E	A	D
Student 1	D	B	A	B	C	A	E	E	A	D
Student 2	E	D	D	A	C	B	E	E	A	D
Student 3	C	B	A	E	D	C	E	E	A	D
Student 4	A	B	D	C	C	D	E	E	A	D
Student 5	B	B	E	C	C	D	E	E	A	D
Student 6	B	B	A	C	C	D	E	E	A	D
Student 7	E	B	E	C	C	D	E	E	A	D

The key is stored in a one-dimensional array:

```

Key to the Questions:
0 1 2 3 4 5 6 7 8 9
Key  D B D C C D A E A D

```

Your program grades the test and displays the result. It compares each student's answers with the key, counts the number of correct answers, and displays it. Listing 7.2 gives the program.

LISTING 7.2 GradeExam.java

```

1  public class GradeExam {
2      /** Main method */
3      public static void main(String[] args) {
4          // Students' answers to the questions
5          char[][] answers = {
6              {'A', 'B', 'A', 'C', 'D', 'E', 'E', 'A', 'D'},
7              {'D', 'B', 'A', 'B', 'C', 'A', 'E', 'E', 'A', 'D'},
8              {'E', 'D', 'D', 'A', 'C', 'B', 'E', 'E', 'A', 'D'},
9              {'C', 'B', 'A', 'E', 'D', 'C', 'E', 'E', 'A', 'D'},
10             {'A', 'B', 'D', 'C', 'C', 'D', 'E', 'E', 'A', 'D'},
11             {'B', 'B', 'E', 'C', 'C', 'D', 'E', 'E', 'A', 'D'},
12             {'B', 'B', 'A', 'C', 'C', 'D', 'E', 'E', 'A', 'D'},
13             {'E', 'B', 'E', 'C', 'C', 'D', 'E', 'E', 'A', 'D'};
14
15         // Key to the questions
16         char[] keys = {'D', 'B', 'D', 'C', 'C', 'D', 'A', 'E', 'A', 'D'};
17
18         // Grade all answers
19         for (int i = 0; i < answers.length; i++) {
20             // Grade one student
21             int correctCount = 0;
22             for (int j = 0; j < answers[i].length; j++) {
23                 if (answers[i][j] == keys[j])
24                     correctCount++;
25             }
26
27             System.out.println("Student " + i + "'s correct count is " +
28                 correctCount);
29         }
30     }
31 }

```

2-D array

1-D array

compare with key

```

Student 0's correct count is 7
Student 1's correct count is 6
Student 2's correct count is 5
Student 3's correct count is 4
Student 4's correct count is 8
Student 5's correct count is 7
Student 6's correct count is 7
Student 7's correct count is 7

```



The statement in lines 5–13 declares, creates, and initializes a two-dimensional array of characters and assigns the reference to `answers` of the `char[][]` type.

The statement in line 16 declares, creates, and initializes an array of `char` values and assigns the reference to `keys` of the `char[]` type.

Each row in the array `answers` stores a student's answer, which is graded by comparing it with the key in the array `keys`. The result is displayed immediately after a student's answer is graded.

7.6 Case Study: Finding the Closest Pair



This section presents a geometric problem for finding the closest pair of points.



closest-pair animation on the Companion Website

Given a set of points, the closest-pair problem is to find the two points that are nearest to each other. In Figure 7.3, for example, points **(1, 1)** and **(2, 0.5)** are closest to each other. There are several ways to solve this problem. An intuitive approach is to compute the distances between all pairs of points and find the one with the minimum distance, as implemented in Listing 7.3.

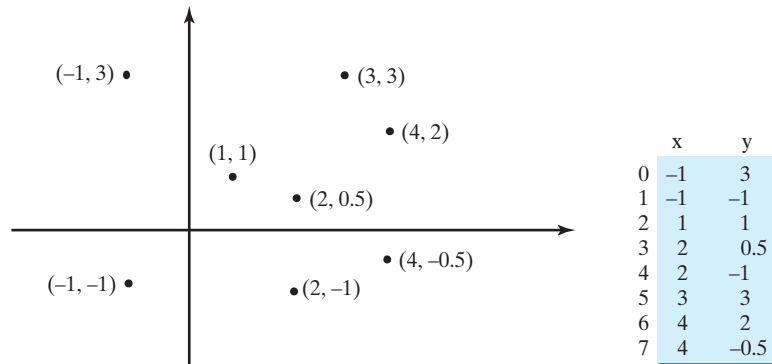


FIGURE 7.3 Points can be represented in a two-dimensional array.

LISTING 7.3 FindNearestPoints.java

```

1  import java.util.Scanner;
2
3  public class FindNearestPoints {
4      public static void main(String[] args) {
5          Scanner input = new Scanner(System.in);
6          System.out.print("Enter the number of points: ");
7          int numberOfPoints = input.nextInt();
8
9          // Create an array to store points
10         double[][] points = new double[numberOfPoints][2];
11         System.out.print("Enter " + numberOfPoints + " points: ");
12         for (int i = 0; i < points.length; i++) {
13             points[i][0] = input.nextDouble();
14             points[i][1] = input.nextDouble();
15         }
16
17         // p1 and p2 are the indices in the points' array
18         int p1 = 0, p2 = 1; // Initial two points
19         double shortestDistance = distance(points[p1][0], points[p1][1],
20             points[p2][0], points[p2][1]); // Initialize shortestDistance
21
22         // Compute distance for every two points
23         for (int i = 0; i < points.length; i++) {

```

number of points

2-D array

read points

track two points

track shortestDistance

for each point i

```

24     for (int j = i + 1; j < points.length; j++) {
25         double distance = distance(points[i][0], points[i][1],
26             points[j][0], points[j][1]); // Find distance
27
28         if (shortestDistance > distance) {
29             p1 = i; // Update p1
30             p2 = j; // Update p2
31             shortestDistance = distance; // Update shortestDistance
32         }
33     }
34 }
35
36 // Display result
37 System.out.println("The closest two points are " +
38     "(" + points[p1][0] + ", " + points[p1][1] + ") and (" +
39     points[p2][0] + ", " + points[p2][1] + ")");
40 }
41
42 /** Compute the distance between two points (x1, y1) and (x2, y2)*/
43 public static double distance(
44     double x1, double y1, double x2, double y2) {
45     return Math.sqrt((x2 - x1) * (x2 - x1) + (y2 - y1) * (y2 - y1));
46 }
47 }

```

for each point j
distance between i and j
distance between two points

update shortestDistance

```

Enter the number of points: 8 ↵
Enter 8 points: -1 3 -1 -1 1 1 2 0.5 2 -1 3 3 4 2 4 -0.5 ↵
The closest two points are (1, 1) and (2, 0.5)

```



The program prompts the user to enter the number of points (lines 6–7). The points are read from the console and stored in a two-dimensional array named `points` (lines 12–15). The program uses the variable `shortestDistance` (line 19) to store the distance between the two nearest points, and the indices of these two points in the `points` array are stored in `p1` and `p2` (line 18).

For each point at index `i`, the program computes the distance between `points[i]` and `points[j]` for all `j > i` (lines 23–34). Whenever a shorter distance is found, the variable `shortestDistance` and `p1` and `p2` are updated (lines 28–32).

The distance between two points `(x1, y1)` and `(x2, y2)` can be computed using the formula $\sqrt{(x_2 - x_1)^2 + (y_2 - y_1)^2}$ (lines 43–46).

The program assumes that the plane has at least two points. You can easily modify the program to handle the case if the plane has zero or one point.

Note that there might be more than one closest pair of points with the same minimum distance. The program finds one such pair. You may modify the program to find all closest pairs in Programming Exercise 7.8.

multiple closest pairs



Tip

It is cumbersome to enter all points from the keyboard. You may store the input in a file, say `FindNearestPoints.txt`, and compile and run the program using the following command:

input file

```
java FindNearestPoints < FindNearestPoints.txt
```

7.7 Case Study: Sudoku



The problem is to check whether a given Sudoku solution is correct.



Sudoku

fixed cells
free cells

This section presents an interesting problem of a sort that appears in the newspaper every day. It is a number-placement puzzle, commonly known as *Sudoku*. This is a very challenging problem. To make it accessible to the novice, this section presents a solution to a simplified version of the Sudoku problem, which is to verify whether a solution is correct. The complete solution for solving the Sudoku problem is presented in Supplement VI.A.

Sudoku is a 9×9 grid divided into smaller 3×3 boxes (also called *regions* or *blocks*), as shown in Figure 7.4a. Some cells, called *fixed cells*, are populated with numbers from **1** to **9**. The objective is to fill the empty cells, also called *free cells*, with the numbers **1** to **9** so that every row, every column, and every 3×3 box contains the numbers **1** to **9**, as shown in Figure 7.4b.

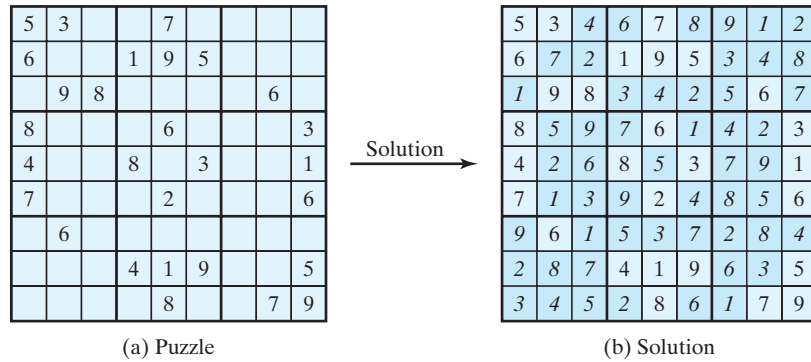


FIGURE 7.4 The Sudoku puzzle in (a) is solved in (b).

representing a grid

For convenience, we use value **0** to indicate a free cell, as shown in Figure 7.5a. The grid can be naturally represented using a two-dimensional array, as shown in Figure 7.5b.

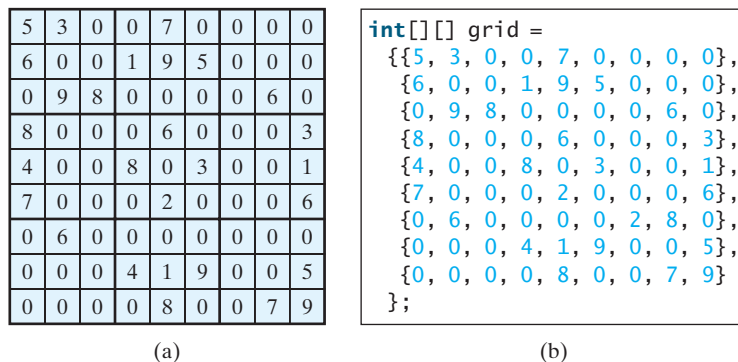


FIGURE 7.5 A grid can be represented using a two-dimensional array.

To find a solution for the puzzle, we must replace each **0** in the grid with an appropriate number from **1** to **9**. For the solution to the puzzle in Figure 7.5, the grid should be as shown in Figure 7.6.

Once a solution to a Sudoku puzzle is found, how do you verify that it is correct? Here are two approaches:

- Check if every row has numbers from **1** to **9**, every column has numbers from **1** to **9**, and every small box has numbers from **1** to **9**.

- Check each cell. Each cell must be a number from **1** to **9** and the cell must be unique on every row, every column, and every small box.

```
A solution grid is
{{5, 3, 4, 6, 7, 8, 9, 1, 2},
 {6, 7, 2, 1, 9, 5, 3, 4, 8},
 {1, 9, 8, 3, 4, 2, 5, 6, 7},
 {8, 5, 9, 7, 6, 1, 4, 2, 3},
 {4, 2, 6, 8, 5, 3, 7, 9, 1},
 {7, 1, 3, 9, 2, 4, 8, 5, 6},
 {9, 6, 1, 5, 3, 7, 2, 8, 4},
 {2, 8, 7, 4, 1, 9, 6, 3, 5},
 {3, 4, 5, 2, 8, 6, 1, 7, 9}
};
```

FIGURE 7.6 A solution is stored in **grid**.

The program in Listing 7.4 prompts the user to enter a solution and reports whether it is valid. We use the second approach in the program to check whether the solution is correct.

LISTING 7.4 CheckSudokuSolution.java

```
1  import java.util.Scanner;
2
3  public class CheckSudokuSolution {
4      public static void main(String[] args) {
5          // Read a Sudoku solution
6          int[][] grid = readASolution();           read input
7
8          System.out.println(isValid(grid) ? "Valid solution" :      solution valid?
9              "Invalid solution");
10     }
11
12     /** Read a Sudoku solution from the console */
13     public static int[][] readASolution() {       read solution
14         // Create a Scanner
15         Scanner input = new Scanner(System.in);
16
17         System.out.println("Enter a Sudoku puzzle solution:");
18         int[][] grid = new int[9][9];
19         for (int i = 0; i < 9; i++)
20             for (int j = 0; j < 9; j++)
21                 grid[i][j] = input.nextInt();
22
23         return grid;
24     }
25
26     /** Check whether a solution is valid */
27     public static boolean isValid(int[][] grid) { check solution
28         for (int i = 0; i < 9; i++)
29             for (int j = 0; j < 9; j++)
30                 if (grid[i][j] < 1 || grid[i][j] > 9
31                     || !isValid(i, j, grid))
32                     return false;
33         return true; // The solution is valid
34     }
35
36     /** Check whether grid[i][j] is valid in the grid */
37     public static boolean isValid(int i, int j, int[][] grid) {
38         // Check whether grid[i][j] is valid in i's row
```

```

39     for (int column = 0; column < 9; column++)
check rows    40         if (column != j && grid[i][column] == grid[i][j])
41             return false;
42
43         // Check whether grid[i][j] is valid in j's column
44         for (int row = 0; row < 9; row++)
check columns  45             if (row != i && grid[row][j] == grid[i][j])
46                 return false;
47
48         // Check whether grid[i][j] is valid in the 3-by-3 box
49         for (int row = (i / 3) * 3; row < (i / 3) * 3 + 3; row++)
check small boxes 50             for (int col = (j / 3) * 3; col < (j / 3) * 3 + 3; col++)
51                 if (row != i && col != j && grid[row][col] == grid[i][j])
52                     return false;
53
54         return true; // The current value at grid[i][j] is valid
55     }
56 }

```



Enter a Sudoku puzzle solution:

9	6	3	1	7	4	2	5	8	↵ Enter
1	7	8	3	2	5	6	4	9	↵ Enter
2	5	4	6	8	9	7	3	1	↵ Enter
8	2	1	4	3	7	5	9	6	↵ Enter
4	9	6	8	5	2	3	1	7	↵ Enter
7	3	5	9	6	1	8	2	4	↵ Enter
5	8	9	7	1	3	4	6	2	↵ Enter
3	1	7	2	4	6	9	8	5	↵ Enter
6	4	2	5	9	8	1	7	3	↵ Enter

Valid solution

The program invokes the `readASolution()` method (line 6) to read a Sudoku solution and return a two-dimensional array representing a Sudoku grid.

`isValid` method

The `isValid(grid)` method checks whether the values in the grid are valid by verifying that each value is between 1 and 9 and that each value is valid in the grid (lines 27–34).

overloaded `isValid` method

The `isValid(i, j, grid)` method checks whether the value at `grid[i][j]` is valid. It checks whether `grid[i][j]` appears more than once in row `i` (lines 39–41), in column `j` (lines 44–46), and in the 3×3 box (lines 49–52).

How do you locate all the cells in the same box? For any `grid[i][j]`, the starting cell of the 3×3 box that contains it is `grid[(i / 3) * 3][(j / 3) * 3]`, as illustrated in Figure 7.7.

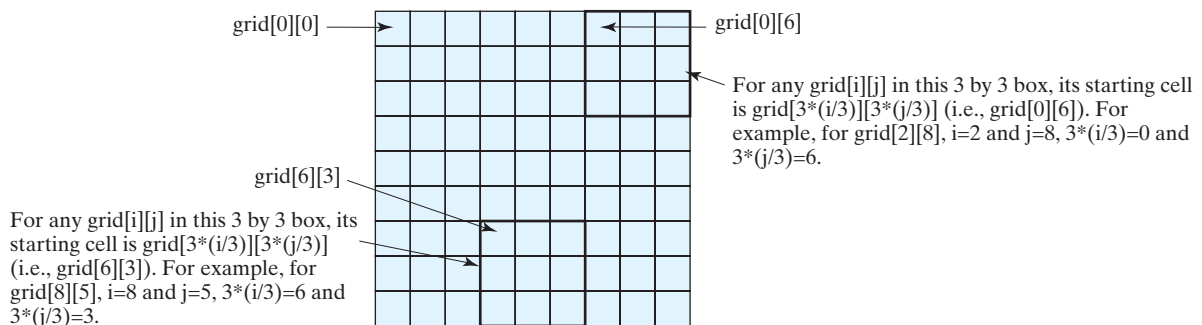


FIGURE 7.7 The location of the first cell in a 3×3 box determines the locations of other cells in the box.

With this observation, you can easily identify all the cells in the box. For instance, if `grid[r][c]` is the starting cell of a 3×3 box, the cells in the box can be traversed in a nested loop as follows:

```
// Get all cells in a 3-by-3 box starting at grid[r][c]
for (int row = r; row < r + 3; row++)
    for (int col = c; col < c + 3; col++)
        // grid[row][col] is in the box
```

It is cumbersome to enter 81 numbers from the console. When you test the program, you may store the input in a file, say `CheckSudokuSolution.txt` (see www.cs.armstrong.edu/liang/data/CheckSudokuSolution.txt), and run the program using the following command:

input file

```
java CheckSudokuSolution < CheckSudokuSolution.txt
```

7.8 Multidimensional Arrays

A two-dimensional array consists of an array of one-dimensional arrays and a three-dimensional array consists of an array of two-dimensional arrays.



In the preceding section, you used a two-dimensional array to represent a matrix or a table. Occasionally, you will need to represent n -dimensional data structures. In Java, you can create n -dimensional arrays for any integer n .

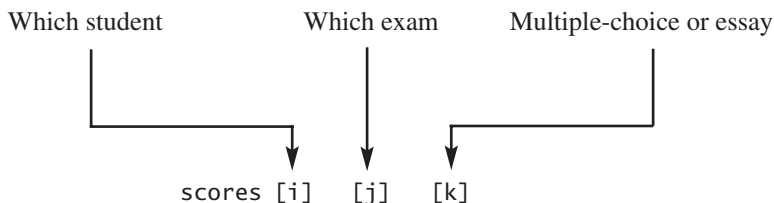
The way to declare two-dimensional array variables and create two-dimensional arrays can be generalized to declare n -dimensional array variables and create n -dimensional arrays for $n \geq 3$. For example, you may use a three-dimensional array to store exam scores for a class of six students with five exams, and each exam has two parts (multiple-choice and essay). The following syntax declares a three-dimensional array variable `scores`, creates an array, and assigns its reference to `scores`.

```
double[][][] scores = new double[6][5][2];
```

You can also use the short-hand notation to create and initialize the array as follows:

```
double[][][] scores = {
    {{7.5, 20.5}, {9.0, 22.5}, {15, 33.5}, {13, 21.5}, {15, 2.5}},
    {{4.5, 21.5}, {9.0, 22.5}, {15, 34.5}, {12, 20.5}, {14, 9.5}},
    {{6.5, 30.5}, {9.4, 10.5}, {11, 33.5}, {11, 23.5}, {10, 2.5}},
    {{6.5, 23.5}, {9.4, 32.5}, {13, 34.5}, {11, 20.5}, {16, 7.5}},
    {{8.5, 26.5}, {9.4, 52.5}, {13, 36.5}, {13, 24.5}, {16, 2.5}},
    {{9.5, 20.5}, {9.4, 42.5}, {13, 31.5}, {12, 20.5}, {16, 6.5}}};
```

`scores[0][1][0]` refers to the multiple-choice score for the first student's second exam, which is **9.0**. `scores[0][1][1]` refers to the essay score for the first student's second exam, which is **22.5**. This is depicted in the following figure:



A multidimensional array is actually an array in which each element is another array. A three-dimensional array consists of an array of two-dimensional arrays. A two-dimensional array consists of an array of one-dimensional arrays. For example, suppose `x = new int[2][2][5]`, and `x[0]` and `x[1]` are two-dimensional arrays. `x[0][0]`, `x[0][1]`, `x[1][0]`, and `x[1][1]` are one-dimensional arrays and each contains five elements.

`x.length` is 2, `x[0].length` and `x[1].length` are 2, and `x[0][0].length`, `x[0][1].length`, `x[1][0].length`, and `x[1][1].length` are 5.

7.8.1 Case Study: Daily Temperature and Humidity

Suppose a meteorology station records the temperature and humidity every hour of every day and stores the data for the past ten days in a text file named **Weather.txt** (see www.cs.armstrong.edu/liang/data/Weather.txt). Each line of the file consists of four numbers that indicate the day, hour, temperature, and humidity. The contents of the file may look like the one in (a).

Day	Hour	Temperature	Humidity
1	1	76.4	0.92
1	2	77.7	0.93
...
10	23	97.7	0.71
10	24	98.7	0.74

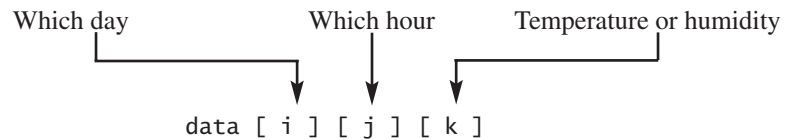
(a)

Day	Hour	Temperature	Humidity
10	24	98.7	0.74
1	2	77.7	0.93
...
10	23	97.7	0.71
1	1	76.4	0.92

(b)

Note that the lines in the file are not necessarily in increasing order of day and hour. For example, the file may appear as shown in (b).

Your task is to write a program that calculates the average daily temperature and humidity for the 10 days. You can use the input redirection to read the file and store the data in a three-dimensional array named `data`. The first index of `data` ranges from 0 to 9 and represents 10 days, the second index ranges from 0 to 23 and represents 24 hours, and the third index ranges from 0 to 1 and represents temperature and humidity, as depicted in the following figure:



Note that the days are numbered from 1 to 10 and the hours from 1 to 24 in the file. Because the array index starts from 0, `data[0][0][0]` stores the temperature in day 1 at hour 1 and `data[9][23][1]` stores the humidity in day 10 at hour 24.

The program is given in Listing 7.5.

LISTING 7.5 Weather.java

```

1  import java.util.Scanner;
2
3  public class Weather {
4      public static void main(String[] args) {
5          final int NUMBER_OF_DAYS = 10;
6          final int NUMBER_OF_HOURS = 24;
7          double[][][] data
8              = new double[NUMBER_OF_DAYS][NUMBER_OF_HOURS][2];
9
10         Scanner input = new Scanner(System.in);
11         // Read input using input redirection from a file
12         for (int k = 0; k < NUMBER_OF_DAYS * NUMBER_OF_HOURS; k++) {
13             int day = input.nextInt();
14             int hour = input.nextInt();
15             double temperature = input.nextDouble();
16             double humidity = input.nextDouble();
17             data[day - 1][hour - 1][0] = temperature;

```

three-dimensional array

```

18     data[day - 1][hour - 1][1] = humidity;
19 }
20
21 // Find the average daily temperature and humidity
22 for (int i = 0; i < NUMBER_OF_DAYS; i++) {
23     double dailyTemperatureTotal = 0, dailyHumidityTotal = 0;
24     for (int j = 0; j < NUMBER_OF_HOURS; j++) {
25         dailyTemperatureTotal += data[i][j][0];
26         dailyHumidityTotal += data[i][j][1];
27     }
28
29     // Display result
30     System.out.println("Day " + i + "'s average temperature is "
31         + dailyTemperatureTotal / NUMBER_OF_HOURS);
32     System.out.println("Day " + i + "'s average humidity is "
33         + dailyHumidityTotal / NUMBER_OF_HOURS);
34 }
35 }
36 }

```



```

Day 0's average temperature is 77.7708
Day 0's average humidity is 0.929583
Day 1's average temperature is 77.3125
Day 1's average humidity is 0.929583
. . .
Day 9's average temperature is 79.3542
Day 9's average humidity is 0.9125

```

You can use the following command to run the program:

```
java Weather < Weather.txt
```

A three-dimensional array for storing temperature and humidity is created in line 8. The loop in lines 12–19 reads the input to the array. You can enter the input from the keyboard, but doing so will be awkward. For convenience, we store the data in a file and use input redirection to read the data from the file. The loop in lines 24–27 adds all temperatures for each hour in a day to `dailyTemperatureTotal` and all humidity for each hour to `dailyHumidityTotal`. The average daily temperature and humidity are displayed in lines 30–33.

7.8.2 Case Study: Guessing Birthdays

Listing 3.3, `GuessBirthday.java`, gives a program that guesses a birthday. The program can be simplified by storing the numbers in five sets in a three-dimensional array, and it prompts the user for the answers using a loop, as shown in Listing 7.6. The sample run of the program can be the same as shown in Listing 3.3.

LISTING 7.6 `GuessBirthdayUsingArray.java`

```

1  import java.util.Scanner;
2
3  public class GuessBirthdayUsingArray {
4      public static void main(String[] args) {
5          int day = 0; // Day to be determined
6          int answer;
7
8          int[][][] dates = {
9              { 1, 3, 5, 7},
10             { 9, 11, 13, 15},

```

three-dimensional array

```

11         {17, 19, 21, 23},
12         {25, 27, 29, 31}},
13     {{ 2, 3, 6, 7},
14     {10, 11, 14, 15},
15     {18, 19, 22, 23},
16     {26, 27, 30, 31}},
17     {{ 4, 5, 6, 7},
18     {12, 13, 14, 15},
19     {20, 21, 22, 23},
20     {28, 29, 30, 31}},
21     {{ 8, 9, 10, 11},
22     {12, 13, 14, 15},
23     {24, 25, 26, 27},
24     {28, 29, 30, 31}},
25     {{16, 17, 18, 19},
26     {20, 21, 22, 23},
27     {24, 25, 26, 27},
28     {28, 29, 30, 31}}};
29
30     // Create a Scanner
31     Scanner input = new Scanner(System.in);
32
33     for (int i = 0; i < 5; i++) {
34         System.out.println("Is your birthday in Set" + (i + 1) + "?");
35         for (int j = 0; j < 4; j++) {
36             for (int k = 0; k < 4; k++)
37                 System.out.printf("%4d", dates[i][j][k]);
38             System.out.println();
39         }
40
41         System.out.print("\nEnter 0 for No and 1 for Yes: ");
42         answer = input.nextInt();
43
44         if (answer == 1)
45             day += dates[i][0][0];
46     }
47
48     System.out.println("Your birthday is " + day);
49 }
50 }

```

Set i

add to day

A three-dimensional array `dates` is created in Lines 8–28. This array stores five sets of numbers. Each set is a 4-by-4 two-dimensional array.

The loop starting from line 33 displays the numbers in each set and prompts the user to answer whether the birthday is in the set (lines 41–42). If the day is in the set, the first number (`dates[i][0][0]`) in the set is added to variable `day` (line 45).



MyProgrammingLab™

- 7.8** Declare an array variable for a three-dimensional array, create a $4 \times 6 \times 5$ `int` array, and assign its reference to the variable.
- 7.9** Assume `int[][][] x = new char[12][5][2]`, how many elements are in the array? What are `x.length`, `x[2].length`, and `x[0][0].length`?
- 7.10** Show the printout of the following code:

```

int[][][] array = {{{1, 2}, {3, 4}}, {{5, 6}, {7, 8}}};
System.out.println(array[0][0][0]);
System.out.println(array[1][1][1]);

```

CHAPTER SUMMARY

1. A two-dimensional array can be used to store a table.
2. A variable for two-dimensional arrays can be declared using the syntax: `elementType[][] arrayVar`.
3. A two-dimensional array can be created using the syntax: `new elementType [ROW_SIZE] [COLUMN_SIZE]`.
4. Each element in a two-dimensional array is represented using the syntax: `arrayVar[rowIndex][columnIndex]`.
5. You can create and initialize a two-dimensional array using an array initializer with the syntax: `elementType[][] arrayVar = {{row values}, . . . , {row values}}`.
6. You can use arrays of arrays to form multidimensional arrays. For example, a variable for three-dimensional arrays can be declared as `elementType[][][] arrayVar`, and a three-dimensional array can be created using `new elementType[size1][size2][size3]`.

TEST QUESTIONS

Do the test questions for this chapter online at www.cs.armstrong.edu/liang/intro9e/test.html.

PROGRAMMING EXERCISES

MyProgrammingLab™

- *7.1** (*Sum elements column by column*) Write a method that returns the sum of all the elements in a specified column in a matrix using the following header:

```
public static double sumColumn(double[][] m, int columnIndex)
```

Write a test program that reads a 3-by-4 matrix and displays the sum of each column. Here is a sample run:

```
Enter a 3-by-4 matrix row by row:
1.5 2 3 4 ↵ Enter
5.5 6 7 8 ↵ Enter
9.5 1 3 1 ↵ Enter
Sum of the elements at column 0 is 16.5
Sum of the elements at column 1 is 9.0
Sum of the elements at column 2 is 13.0
Sum of the elements at column 3 is 13.0
```



- *7.2** (*Sum the major diagonal in a matrix*) Write a method that sums all the numbers in the major diagonal in an $n \times n$ matrix of integers using the following header:

```
public static double sumMajorDiagonal(double[][] m)
```

Write a test program that reads a 4-by-4 matrix and displays the sum of all its elements on the major diagonal. Here is a sample run:



Enter a 4-by-4 matrix row by row:

```
1 2 3 4.0 ↵
5 6.5 7 8 ↵
9 10 11 12 ↵
13 14 15 16 ↵
```

Sum of the elements in the major diagonal is 34.5

***7.3** (*Sort students on grades*) Rewrite Listing 7.2, `GradeExam.java`, to display the students in increasing order of the number of correct answers.

****7.4** (*Compute the weekly hours for each employee*) Suppose the weekly hours for all employees are stored in a two-dimensional array. Each row records an employee's seven-day work hours with seven columns. For example, the following array stores the work hours for eight employees. Write a program that displays employees and their total hours in decreasing order of the total hours.

	Su	M	T	W	Th	F	Sa
Employee 0	2	4	3	4	5	8	8
Employee 1	7	3	4	3	3	4	4
Employee 2	3	3	4	3	3	2	2
Employee 3	9	3	4	7	3	4	1
Employee 4	3	5	4	3	6	3	8
Employee 5	3	4	4	6	3	4	4
Employee 6	3	7	4	8	3	8	4
Employee 7	6	3	5	9	2	7	9

7.5 (*Algebra: add two matrices*) Write a method to add two matrices. The header of the method is as follows:

```
public static double[][] addMatrix(double[][] a, double[][] b)
```

In order to be added, the two matrices must have the same dimensions and the same or compatible types of elements. Let **c** be the resulting matrix. Each element c_{ij} is $a_{ij} + b_{ij}$. For example, for two 3×3 matrices **a** and **b**, **c** is

$$\begin{pmatrix} a_{11} & a_{12} & a_{13} \\ a_{21} & a_{22} & a_{23} \\ a_{31} & a_{32} & a_{33} \end{pmatrix} + \begin{pmatrix} b_{11} & b_{12} & b_{13} \\ b_{21} & b_{22} & b_{23} \\ b_{31} & b_{32} & b_{33} \end{pmatrix} = \begin{pmatrix} a_{11} + b_{11} & a_{12} + b_{12} & a_{13} + b_{13} \\ a_{21} + b_{21} & a_{22} + b_{22} & a_{23} + b_{23} \\ a_{31} + b_{31} & a_{32} + b_{32} & a_{33} + b_{33} \end{pmatrix}$$

Write a test program that prompts the user to enter two 3×3 matrices and displays their sum. Here is a sample run:



VideoNote

Multiply two matrices



```
Enter matrix1: 1 2 3 4 5 6 7 8 9 ↵
Enter matrix2: 0 2 4 1 4.5 2.2 1.1 4.3 5.2 ↵
The matrices are added as follows
1.0 2.0 3.0    0.0 2.0 4.0    1.0 4.0 7.0
4.0 5.0 6.0 + 1.0 4.5 2.2 = 5.0 9.5 8.2
7.0 8.0 9.0    1.1 4.3 5.2    8.1 12.3 14.2
```

- **7.6** (*Algebra: multiply two matrices*) Write a method to multiply two matrices. The header of the method is:

```
public static double[][]
    multiplyMatrix(double[][] a, double[][] b)
```

To multiply matrix **a** by matrix **b**, the number of columns in **a** must be the same as the number of rows in **b**, and the two matrices must have elements of the same or compatible types. Let **c** be the result of the multiplication. Assume the column size of matrix **a** is **n**. Each element c_{ij} is $a_{i1} \times b_{1j} + a_{i2} \times b_{2j} + \dots + a_{in} \times b_{nj}$. For example, for two 3×3 matrices **a** and **b**, **c** is

$$\begin{pmatrix} a_{11} & a_{12} & a_{13} \\ a_{21} & a_{22} & a_{23} \\ a_{31} & a_{32} & a_{33} \end{pmatrix} \times \begin{pmatrix} b_{11} & b_{12} & b_{13} \\ b_{21} & b_{22} & b_{23} \\ b_{31} & b_{32} & b_{33} \end{pmatrix} = \begin{pmatrix} c_{11} & c_{12} & c_{13} \\ c_{21} & c_{22} & c_{23} \\ c_{31} & c_{32} & c_{33} \end{pmatrix}$$

where $c_{ij} = a_{i1} \times b_{1j} + a_{i2} \times b_{2j} + a_{i3} \times b_{3j}$.

Write a test program that prompts the user to enter two 3×3 matrices and displays their product. Here is a sample run:

```
Enter matrix1: 1 2 3 4 5 6 7 8 9 ↵Enter
Enter matrix2: 0 2 4 1 4.5 2.2 1.1 4.3 5.2 ↵Enter
The multiplication of the matrices is
1 2 3      0 2.0 4.0      5.3 23.9 24
4 5 6      * 1 4.5 2.2 = 11.6 56.3 58.2
7 8 9      1.1 4.3 5.2    17.9 88.7 92.4
```



- *7.7** (*Points nearest to each other*) Listing 7.3 gives a program that finds two points in a two-dimensional space nearest to each other. Revise the program so that it finds two points in a three-dimensional space nearest to each other. Use a two-dimensional array to represent the points. Test the program using the following points:

```
double[][] points = {{-1, 0, 3}, {-1, -1, -1}, {4, 1, 1},
    {2, 0.5, 9}, {3.5, 2, -1}, {3, 1.5, 3}, {-1.5, 4, 2},
    {5.5, 4, -0.5}};
```

The formula for computing the distance between two points (x_1, y_1, z_1) and (x_2, y_2, z_2) is $\sqrt{(x_2 - x_1)^2 + (y_2 - y_1)^2 + (z_2 - z_1)^2}$.

- **7.8** (*All closest pairs of points*) Revise Listing 7.3, FindNearestPoints.java, to find all closest pairs of points with the same minimum distance.
- ***7.9** (*Game: play a tic-tac-toe game*) In a game of tic-tac-toe, two players take turns marking an available cell in a 3×3 grid with their respective tokens (either X or O). When one player has placed three tokens in a horizontal, vertical, or diagonal row on the grid, the game is over and that player has won. A draw (no winner) occurs when all the cells on the grid have been filled with tokens and neither player has achieved a win. Create a program for playing tic-tac-toe.
- The program prompts two players to enter an X token and O token alternately. Whenever a token is entered, the program redisplay the board on the console and determines the status of the game (win, draw, or continue). Here is a sample run:



```

-----
| | | |
-----
| | | |
-----
| | | |
-----
Enter a row (0, 1, or 2) for player X: 1 ↵Enter
Enter a column (0, 1, or 2) for player X: 1 ↵Enter

-----
| | | |
-----
| | X | |
-----
| | | |
-----
Enter a row (0, 1, or 2) for player 0: 1 ↵Enter
Enter a column (0, 1, or 2) for player 0: 2 ↵Enter

-----
| | | |
-----
| | X | 0 |
-----
| | | |
-----
Enter a row (0, 1, or 2) for player X:
. . .

-----
| X | | |
-----
| 0 | X | 0 |
-----
| | | X |
-----
X player won

```

***7.10** (*Largest row and column*) Write a program that randomly fills in 0s and 1s into a 4-by-4 matrix, prints the matrix, and finds the first row and column with the most 1s. Here is a sample run of the program:

```

0011
0011
1101
1010
The largest row index: 2
The largest column index: 2

```

****7.11** (*Game: nine heads and tails*) Nine coins are placed in a 3-by-3 matrix with some face up and some face down. You can represent the state of the coins using a 3-by-3 matrix with values **0** (heads) and **1** (tails). Here are some examples:

```

0 0 0   1 0 1   1 1 0   1 0 1   1 0 0
0 1 0   0 0 1   1 0 0   1 1 0   1 1 1
0 0 0   1 0 0   0 0 1   1 0 0   1 1 0

```


Each state can also be represented using a binary number. For example, the preceding matrices correspond to the numbers

```
000010000 101001100 110100001 101110100 100111110
```

There are a total of 512 possibilities, so you can use decimal numbers 0, 1, 2, 3, . . . , and 511 to represent all states of the matrix. Write a program that prompts the user to enter a number between 0 and 511 and displays the corresponding matrix with the characters **H** and **T**. Here is a sample run:

```
Enter a number between 0 and 511: 7 
H H H
H H H
T T T
```



The user entered 7, which corresponds to 000000111. Since 0 stands for **H** and 1 for **T**, the output is correct.

****7.12** (*Financial application: compute tax*) Rewrite Listing 3.6, ComputeTax.java, using arrays. For each filing status, there are six tax rates. Each rate is applied to a certain amount of taxable income. For example, from the taxable income of \$400,000 for a single filer, \$8,350 is taxed at 10%, (33,950 – 8,350) at 15%, (82,250 – 33,950) at 25%, (171,550 – 82,250) at 28%, (372,550 – 82,250) at 33%, and (400,000 – 372,550) at 36%. The six rates are the same for all filing statuses, which can be represented in the following array:

```
double[] rates = {0.10, 0.15, 0.25, 0.28, 0.33, 0.35};
```

The brackets for each rate for all the filing statuses can be represented in a two-dimensional array as follows:

```
int[][] brackets = {
    {8350, 33950, 82250, 171550, 372950}, // Single filer
    {16700, 67900, 137050, 20885, 372950}, // Married jointly
    // or qualifying widow(er)
    {8350, 33950, 68525, 104425, 186475}, // Married separately
    {11950, 45500, 117450, 190200, 372950} // Head of household
};
```

Suppose the taxable income is \$400,000 for single filers. The tax can be computed as follows:

```
tax = brackets[0][0] * rates[0] +
    (brackets[0][1] - brackets[0][0]) * rates[1] +
    (brackets[0][2] - brackets[0][1]) * rates[2] +
    (brackets[0][3] - brackets[0][2]) * rates[3] +
    (brackets[0][4] - brackets[0][3]) * rates[4] +
    (400000 - brackets[0][4]) * rates[5]
```

***7.13** (*Locate the largest element*) Write the following method that returns the location of the largest element in a two-dimensional array.

```
public static int[] locateLargest(double[][] a)
```

The return value is a one-dimensional array that contains two elements. These two elements indicate the row and column indices of the largest element in the two-dimensional array. Write a test program that prompts the user to enter a

two-dimensional array and displays the location of the largest element in the array. Here is a sample run:



```
Enter the number of rows and columns of the array: 3 4 ↵Enter
Enter the array:
23.5 35 2 10 ↵Enter
4.5 3 45 3.5 ↵Enter
35 44 5.5 9.6 ↵Enter
The location of the largest element is at (1, 2)
```

****7.14** (*Explore matrix*) Write a program that prompts the user to enter the length of a square matrix, randomly fills in **0s** and **1s** into the matrix, prints the matrix, and finds the rows, columns, and diagonals with all **0s** or **1s**. Here is a sample run of the program:



```
Enter the size for the matrix: 4 ↵Enter
0111
0000
0100
1111
All 0s on row 1
All 1s on row 3
No same numbers on a column
No same numbers on the major diagonal
No same numbers on the sub-diagonal
```

***7.15** (*Geometry: same line?*) Programming Exercise 5.39 gives a method for testing whether three points are on the same line.

Write the following method to test whether all the points in the array **points** are on the same line.

```
public static boolean sameLine(double[][] points)
```

Write a program that prompts the user to enter five points and displays whether they are on the same line. Here are sample runs:



```
Enter five points: 3.4 2 6.5 9.5 2.3 2.3 5.5 5 -5 4 ↵Enter
The five points are not on the same line
```



```
Enter five points: 1 1 2 2 3 3 4 4 5 5 ↵Enter
The five points are on the same line
```

***7.16** (*Sort two-dimensional array*) Write a method to sort a two-dimensional array using the following header:

```
public static void sort(int m[][])
```

The method performs a primary sort on rows and a secondary sort on columns. For example, the following array

```
{ {4, 2}, {1, 7}, {4, 5}, {1, 2}, {1, 1}, {4, 1} }
```

will be sorted to

```
{ {1, 1}, {1, 2}, {1, 7}, {4, 1}, {4, 2}, {4, 5} }.
```

*****7.17** (*Financial tsunami*) Banks lend money to each other. In tough economic times, if a bank goes bankrupt, it may not be able to pay back the loan. A bank's total assets are its current balance plus its loans to other banks. The diagram in Figure 7.8 shows five banks. The banks' current balances are 25, 125, 175, 75, and 181 million dollars, respectively. The directed edge from node 1 to node 2 indicates that bank 1 lends 40 million dollars to bank 2.

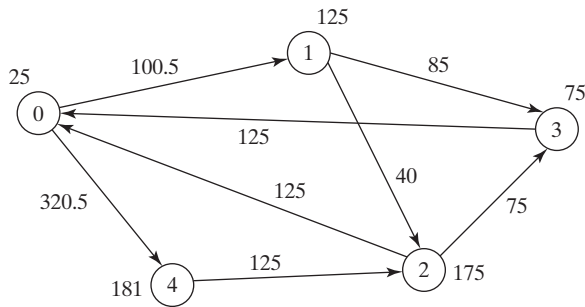


FIGURE 7.8 Banks lend money to each other.

If a bank's total assets are under a certain limit, the bank is unsafe. The money it borrowed cannot be returned to the lender, and the lender cannot count the loan in its total assets. Consequently, the lender may also be unsafe, if its total assets are under the limit. Write a program to find all the unsafe banks. Your program reads the input as follows. It first reads two integers n and $limit$, where n indicates the number of banks and $limit$ is the minimum total assets for keeping a bank safe. It then reads n lines that describe the information for n banks with IDs from 0 to $n-1$.

The first number in the line is the bank's balance, the second number indicates the number of banks that borrowed money from the bank, and the rest are pairs of two numbers. Each pair describes a borrower. The first number in the pair is the borrower's ID and the second is the amount borrowed. For example, the input for the five banks in Figure 7.8 is as follows (note that the limit is 201):

```
5 201
25 2 1 100.5 4 320.5
125 2 2 40 3 85
175 2 0 125 3 75
75 1 0 125
181 1 2 125
```

The total assets of bank 3 are $(75 + 125)$, which is under 201, so bank 3 is unsafe. After bank 3 becomes unsafe, the total assets of bank 1 fall below $(125 + 40)$. Thus, bank 1 is also unsafe. The output of the program should be

```
Unsafe banks are 3 1
```

(Hint: Use a two-dimensional array `borrowers` to represent loans. `borrowers[i][j]` indicates the loan that bank `i` loans to bank `j`. Once bank `j` becomes unsafe, `borrowers[i][j]` should be set to `0`.)

***7.18** (*Shuffle rows*) Write a method that shuffles the rows in a two-dimensional `int` array using the following header:

```
public static void shuffle(int[][] m)
```

Write a test program that shuffles the following matrix:

```
int[][] m = {{1, 2}, {3, 4}, {5, 6}, {7, 8}, {9, 10}};
```

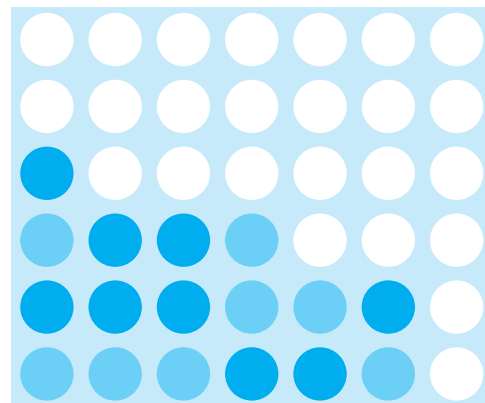
****7.19** (*Pattern recognition: four consecutive equal numbers*) Write the following method that tests whether a two-dimensional array has four consecutive numbers of the same value, either horizontally, vertically, or diagonally.

```
public static boolean isConsecutiveFour(int[][] values)
```

Write a test program that prompts the user to enter the number of rows and columns of a two-dimensional array and then the values in the array and displays true if the array contains four consecutive numbers with the same value. Otherwise, display false. Here are some examples of the true cases:

0 1 0 3 1 6 1	0 1 0 3 1 6 1	0 1 0 3 1 6 1	0 1 0 3 1 6 1
0 1 6 8 6 0 1	0 1 6 8 6 0 1	0 1 6 8 6 0 1	0 1 6 8 6 0 1
5 6 2 1 8 2 9	5 5 2 1 8 2 9	5 6 2 1 6 2 9	9 6 2 1 8 2 9
6 5 6 1 1 9 1	6 5 6 1 1 9 1	6 5 6 6 1 9 1	6 9 6 1 1 9 1
1 3 6 1 4 0 7	1 5 6 1 4 0 7	1 3 6 1 4 0 7	1 3 9 1 4 0 7
3 3 3 3 4 0 7	3 5 3 3 4 0 7	3 6 3 3 4 0 7	3 3 3 9 4 0 7

*****7.20** (*Game: connect four*) Connect four is a two-player board game in which the players alternately drop colored disks into a seven-column, six-row vertically suspended grid, as shown below.



The objective of the game is to connect four same-colored disks in a row, a column, or a diagonal before your opponent can do likewise. The program prompts two players to drop a red or yellow disk alternately. In the preceding figure, the red disk is shown in a dark color and the yellow in a light color. Whenever a disk is dropped, the program redisplay the board on the console and determines the status of the game (win, draw, or continue). Here is a sample run:



```

| | | | | | |
| | | | | | |
| | | | | | |
| | | | | | |
| | | | | | |
| | | | | | |
-----
Drop a red disk at column (0-6): 0 ↵ Enter

| | | | | | |
| | | | | | |
| | | | | | |
| | | | | | |
|R| | | | | |
| | | | | | |
-----
Drop a yellow disk at column (0-6): 3 ↵ Enter

| | | | | | | |
| | | | | | |
| | | | | | |
|R| | |Y| | | |
| | | | | | |
| | | | | | |
. . .
. . .
. . .
Drop a yellow disk at column (0-6): 6 ↵ Enter

| | | | | | | |
| | | | | | |
| | | |R| | | |
| | | |Y|R|Y| |
| | |R|Y|Y|Y|Y|
|R|Y|R|Y|R|R|R|
-----
The yellow player won
    
```

***7.21** (*Central city*) Given a set of cities, the central point is the city that has the shortest total distance to all other cities. Write a program that prompts the user to enter the number of the cities and the locations of the cities (coordinates), and finds the central city.

```

Enter the number of cities: 5 ↵ Enter
Enter the coordinates of the cities:
2.5 5 5.1 3 1 9 5.4 54 5.5 2.1 ↵ Enter
The central city is at (2.5, 5.0)
    
```



***7.22** (*Even number of 1s*) Write a program that generates a 6-by-6 two-dimensional matrix filled with 0s and 1s, displays the matrix, and checks if every row and every column have an even number of 1s.

***7.23** (*Game: find the flipped cell*) Suppose you are given a 6-by-6 matrix filled with 0s and 1s. All rows and all columns have an even number of 1s. Let the user flip one



VideoNote
Even number of 1s

cell (i.e., flip from 1 to 0 or from 0 to 1) and write a program to find which cell was flipped. Your program should prompt the user to enter a 6-by-6 array with 0s and 1s and find the first row r and first column c where the even number of the 1s property is violated (i.e., the number of 1s is not even). The flipped cell is at (r, c) .

***7.24** (*Check Sudoku solution*) Listing 7.4 checks whether a solution is valid by checking whether every number is valid in the board. Rewrite the program by checking whether every row, every column, and every small box has the numbers 1 to 9.

***7.25** (*Markov matrix*) An $n \times n$ matrix is called a *positive Markov matrix* if each element is positive and the sum of the elements in each column is 1. Write the following method to check whether a matrix is a Markov matrix.

```
public static boolean isMarkovMatrix(double[][] m)
```

Write a test program that prompts the user to enter a 3×3 matrix of double values and tests whether it is a Markov matrix. Here are sample runs:



```
Enter a 3-by-3 matrix row by row:
0.15 0.875 0.375 ↵ Enter
0.55 0.005 0.225 ↵ Enter
0.30 0.12 0.4 ↵ Enter
It is a Markov matrix
```



```
Enter a 3-by-3 matrix row by row:
0.95 -0.875 0.375 ↵ Enter
0.65 0.005 0.225 ↵ Enter
0.30 0.22 -0.4 ↵ Enter
It is not a Markov matrix
```

***7.26** (*Row sorting*) Implement the following method to sort the rows in a two-dimensional array. A new array is returned and the original array is intact.

```
public static double[][] sortRows(double[][] m)
```

Write a test program that prompts the user to enter a 3×3 matrix of double values and displays a new row-sorted matrix. Here is a sample run:



```
Enter a 3-by-3 matrix row by row:
0.15 0.875 0.375 ↵ Enter
0.55 0.005 0.225 ↵ Enter
0.30 0.12 0.4 ↵ Enter

The row-sorted array is
0.15 0.375 0.875
0.005 0.225 0.55
0.12 0.30 0.4
```

***7.27** (*Column sorting*) Implement the following method to sort the columns in a two-dimensional array. A new array is returned and the original array is intact.

```
public static double[][] sortColumns(double[][] m)
```

Write a test program that prompts the user to enter a 3×3 matrix of double values and displays a new column-sorted matrix. Here is a sample run:

Enter a 3-by-4 matrix row by row:

0.15 0.875 0.375 ↵Enter

0.55 0.005 0.225 ↵Enter

0.30 0.12 0.4 ↵Enter

The column-sorted array is

0.15 0.0050 0.225

0.3 0.12 0.375

0.55 0.875 0.4



7.28 (*Strictly identical arrays*) The two-dimensional arrays `m1` and `m2` are *strictly identical* if their corresponding elements are equal. Write a method that returns `true` if `m1` and `m2` are strictly identical, using the following header:

```
public static boolean equals(int[][] m1, int[][] m2)
```

Write a test program that prompts the user to enter two 3×3 arrays of integers and displays whether the two are strictly identical. Here are the sample runs.

Enter list1: 51 22 25 6 1 4 24 54 6 ↵Enter

Enter list2: 51 22 25 6 1 4 24 54 6 ↵Enter

The two arrays are strictly identical



Enter list1: 51 25 22 6 1 4 24 54 6 ↵Enter

Enter list2: 51 22 25 6 1 4 24 54 6 ↵Enter

The two arrays are not strictly identical



7.29 (*Identical arrays*) The two-dimensional arrays `m1` and `m2` are *identical* if they have the same contents. Write a method that returns `true` if `m1` and `m2` are identical, using the following header:

```
public static boolean equals(int[][] m1, int[][] m2)
```

Write a test program that prompts the user to enter two lists of integers and displays whether the two are identical. Here are the sample runs.

Enter list1: 51 25 22 6 1 4 24 54 6 ↵Enter

Enter list2: 51 22 25 6 1 4 24 54 6 ↵Enter

The two arrays are identical



Enter list1: 51 5 22 6 1 4 24 54 6 ↵Enter

Enter list2: 51 22 25 6 1 4 24 54 6 ↵Enter

The two arrays are not identical



- *7.30** (*Algebra: solve linear equations*) Write a method that solves the following 2×2 system of linear equations:

$$\begin{aligned} a_{00}x + a_{01}y &= b_0 \\ a_{10}x + a_{11}y &= b_1 \end{aligned} \quad x = \frac{b_0a_{11} - b_1a_{01}}{a_{00}a_{11} - a_{01}a_{10}} \quad y = \frac{b_1a_{00} - b_0a_{10}}{a_{00}a_{11} - a_{01}a_{10}}$$

The method header is

```
public static double[] linearEquation(double[][] a, double[] b)
```

The method returns **null** if $a_{00}a_{11} - a_{01}a_{10}$ is **0**. Write a test program that prompts the user to enter a_{00} , a_{01} , a_{10} , a_{11} , b_0 , and b_1 , and displays the result. If $a_{00}a_{11} - a_{01}a_{10}$ is **0**, report that “The equation has no solution.” A sample run is similar to Programming Exercise 3.3.

- *7.31** (*Geometry: intersecting point*) Write a method that returns the intersecting point of two lines. The intersecting point of the two lines can be found by using the formula shown in Programming Exercise 3.25. Assume that (x_1, y_1) and (x_2, y_2) are the two points on line 1 and (x_3, y_3) and (x_4, y_4) are on line 2. The method header is

```
public static double[] getIntersectingPoint(double[][] points)
```

The points are stored in a 4-by-2 two-dimensional array **points** with **points[0][0]**, **points[0][1]** for (x_1, y_1) . The method returns the intersecting point or **null** if the two lines are parallel. Write a program that prompts the user to enter four points and displays the intersecting point. See Programming Exercise 3.25 for a sample run.

- *7.32** (*Geometry: area of a triangle*) Write a method that returns the area of a triangle using the following header:

```
public static double getTriangleArea(double[][] points)
```

The points are stored in a 3-by-2 two-dimensional array **points** with **points[0][0]** and **points[0][1]** for (x_1, y_1) . The triangle area can be computed using the formula in Programming Exercise 2.15. The method returns **0** if the three points are on the same line. Write a program that prompts the user to enter two lines and displays the intersecting point. Here is a sample run of the program:



```
Enter x1, y1, x2, y2, x3, y3: 2.5 2 5 -1.0 4.0 2.0 ↵Enter
The area of the triangle is 2.25
```



```
Enter x1, y1, x2, y2, x3, y3: 2 2 4.5 4.5 6 6 ↵Enter
The three points are on the same line
```

- *7.33** (*Geometry: polygon subareas*) A convex 4-vertex polygon is divided into four triangles, as shown in Figure 7.9.

Write a program that prompts the user to enter the coordinates of four vertices and displays the areas of the four triangles in increasing order. Here is a sample run:



```
Enter x1, y1, x2, y2, x3, y3, x4, y4:
-2.5 2 4 4 3 -2 -2 -3.5 ↵Enter
The areas are 6.17 7.96 8.08 10.42
```

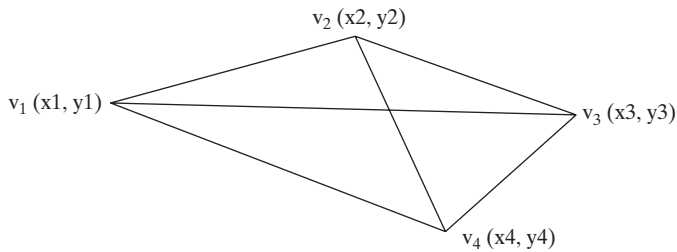



FIGURE 7.9 A 4-vertex polygon is defined by four vertices.

- *7.34** (*Geometry: rightmost lowest point*) In computational geometry, often you need to find the rightmost lowest point in a set of points. Write the following method that returns the rightmost lowest point in a set of points.

```
public static double[]
    getRightmostLowestPoint(double[][] points)
```

Write a test program that prompts the user to enter the coordinates of six points and displays the rightmost lowest point. Here is a sample run:

```
Enter 6 points: 1.5 2.5 -3 4.5 5.6 -7 6.5 -7 8 1 10 2.5 ↵Enter
The rightmost lowest point is (6.5, -7.0)
```



- **7.35** (*Largest block*) Given a square matrix with the elements 0 or 1, write a program to find a maximum square submatrix whose elements are all 1s. Your program should prompt the user to enter the number of rows in the matrix. The program then displays the location of the first element in the maximum square submatrix and the number of the rows in the submatrix. Here is a sample run:

```
Enter the number of rows in the matrix: 5 ↵Enter
Enter the matrix row by row:
1 0 1 0 1 ↵Enter
1 1 1 0 1 ↵Enter
1 0 1 1 1 ↵Enter
1 0 1 1 1 ↵Enter
1 0 1 1 1 ↵Enter
```

```
The maximum square submatrix is at (2, 2) with size 3
```



Your program should implement and use the following method to find the maximum square submatrix:

```
public static int[] findLargestBlock(int[][] m)
```

The return value is an array that consists of three values. The first two values are the row and column indices for the first element in the submatrix, and the third value is the number of the rows in the submatrix.

- **7.36** (*Latin square*) A Latin square is an n -by- n array filled with n different Latin letters, each occurring exactly once in each row and once in each column. Write a

program that prompts the user to enter the number **n** and the array of characters, as shown in the sample output, and checks if the input array is a Latin square. The characters are the first **n** characters starting from **A**.



```
Enter number n: 4 
Enter 4 rows of letters separated by spaces:
A B C D 
B A D C 
C D B A 
D C A B 
The input array is a Latin square
```



```
Enter number n: 3 
Enter 3 rows of letters separated by spaces:
A F D 
Wrong input: the letters must be from A to C
```

OBJECTS AND CLASSES

Objectives

- To describe objects and classes, and use classes to model objects (§8.2).
- To use UML graphical notation to describe classes and objects (§8.2).
- To demonstrate how to define classes and create objects (§8.3).
- To create objects using constructors (§8.4).
- To access objects via object reference variables (§8.5).
- To define a reference variable using a reference type (§8.5.1).
- To access an object's data and methods using the object member access operator (`.`) (§8.5.2).
- To define data fields of reference types and assign default values for an object's data fields (§8.5.3).
- To distinguish between object reference variables and primitive data type variables (§8.5.4).
- To use the Java library classes `Date`, `Random`, and `JFrame` (§8.6).
- To distinguish between instance and static variables and methods (§8.7).
- To define private data fields with appropriate `get` and `set` methods (§8.8).
- To encapsulate data fields to make classes easy to maintain (§8.9).
- To develop methods with object arguments and differentiate between primitive-type arguments and object-type arguments (§8.10).
- To store and process objects in arrays (§8.11).



8.1 Introduction



Object-oriented programming enables you to develop large-scale software and GUIs effectively.

Having learned the material in the preceding chapters, you are able to solve many programming problems using selections, loops, methods, and arrays. However, these Java features are not sufficient for developing graphical user interfaces and large-scale software systems. Suppose you want to develop a graphical user interface (GUI, pronounced *goo-ee*) as shown in Figure 8.1. How would you program it? You will learn how in this chapter.

why OOP?

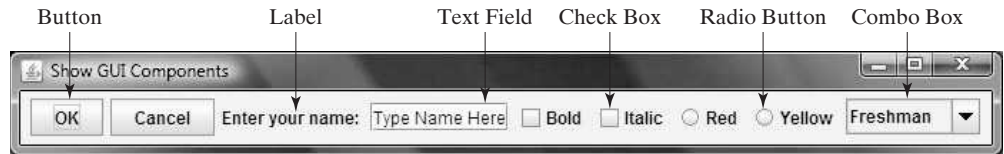


FIGURE 8.1 The GUI objects are created from classes.

This chapter introduces object-oriented programming, which you can use to develop GUI and large-scale software systems.

8.2 Defining Classes for Objects



A class defines the properties and behaviors for objects.

Object-oriented programming (OOP) involves programming using objects. An *object* represents an entity in the real world that can be distinctly identified. For example, a student, a desk, a circle, a button, and even a loan can all be viewed as objects. An object has a unique identity, state, and behavior.

- The *state* of an object (also known as its *properties* or *attributes*) is represented by *data fields* with their current values. A circle object, for example, has a data field **radius**, which is the property that characterizes a circle. A rectangle object has the data fields **width** and **height**, which are the properties that characterize a rectangle.
- The *behavior* of an object (also known as its *actions*) is defined by methods. To invoke a method on an object is to ask the object to perform an action. For example, you may define methods named **getArea()** and **getPerimeter()** for circle objects. A circle object may invoke **getArea()** to return its area and **getPerimeter()** to return its perimeter. You may also define the **setRadius(radius)** method. A circle object can invoke this method to change its radius.

Objects of the same type are defined using a common class. A *class* is a template, blueprint, or *contract* that defines what an object's data fields and methods will be. An object is an instance of a class. You can create many instances of a class. Creating an instance is referred to as *instantiation*. The terms *object* and *instance* are often interchangeable. The relationship between classes and objects is analogous to that between an apple-pie recipe and apple pies: You can make as many apple pies as you want from a single recipe. Figure 8.2 shows a class named **Circle** and its three objects.

A Java class uses variables to define data fields and methods to define actions. Additionally, a class provides methods of a special type, known as *constructors*, which are invoked to create a new object. A constructor can perform any action, but constructors are designed to perform initializing actions, such as initializing the data fields of objects. Figure 8.3 shows an example of defining the class for circle objects.



VideoNote

Define classes and objects

object
state of an object
properties
attributes
data fields
behavior
actions

class
contract

instantiation
instance

data field
method
constructors

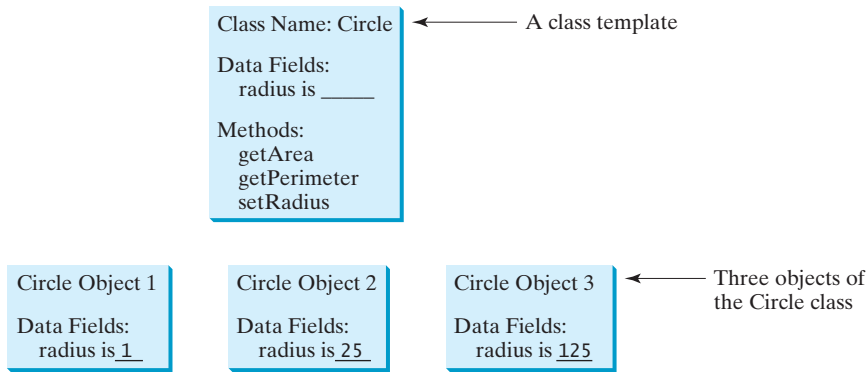


FIGURE 8.2 A class is a template for creating objects.

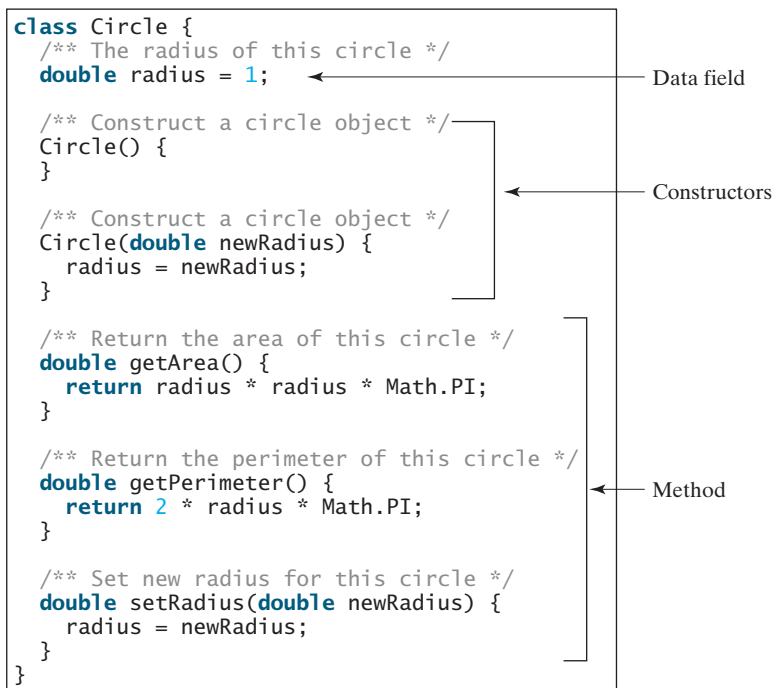


FIGURE 8.3 A class is a construct that defines objects of the same type.

The **Circle** class is different from all of the other classes you have seen thus far. It does not have a **main** method and therefore cannot be run; it is merely a definition for circle objects. The class that contains the **main** method will be referred to in this book, for convenience, as the *main class*.

The illustration of class templates and objects in Figure 8.2 can be standardized using *Unified Modeling Language (UML)* notation. This notation, as shown in Figure 8.4, is called a *UML class diagram*, or simply a *class diagram*. In the class diagram, the data field is denoted as

dataFieldName: dataType

The constructor is denoted as

ClassName(parameterName: parameterType)

main class
Unified Modeling Language
(UML)
class diagram

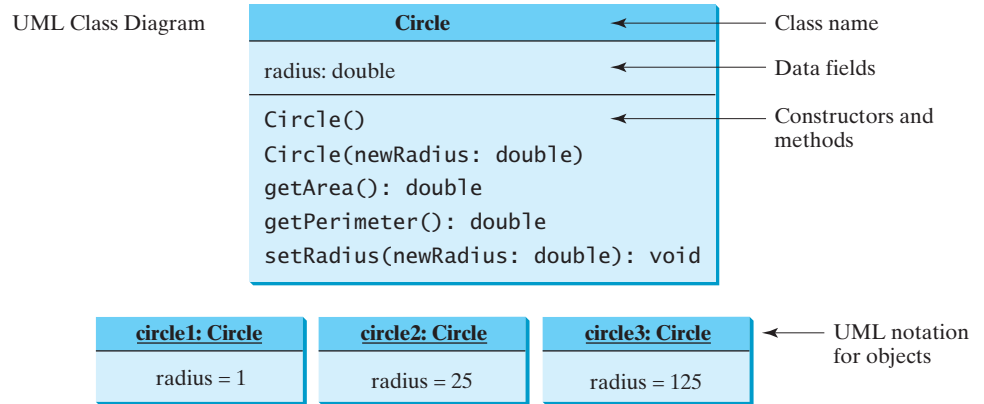


FIGURE 8.4 Classes and objects can be represented using UML notation.

The method is denoted as

```
methodName(parameterName: parameterType): returnType
```

8.3 Example: Defining Classes and Creating Objects

Classes are definitions for objects and objects are created from classes.



This section gives two examples of defining classes and uses the classes to create objects. Listing 8.1 is a program that defines the **Circle** class and uses it to create objects. The program constructs three circle objects with radius **1**, **25**, and **125** and displays the radius and area of each of the three circles. It then changes the radius of the second object to **100** and displays its new radius and area.



Note

To avoid a naming conflict with several enhanced versions of the **Circle** class introduced later in the chapter, the **Circle** class in this example is named **SimpleCircle**. For simplicity, we will still refer to the class in the text as **Circle**.

avoid naming conflicts

LISTING 8.1 TestSimpleCircle.java

```

1 public class TestSimpleCircle {
2     /** Main method */
3     public static void main(String[] args) {
4         // Create a circle with radius 1
5         SimpleCircle circle1 = new SimpleCircle();
6         System.out.println("The area of the circle of radius "
7             + circle1.radius + " is " + circle1.getArea());
8
9         // Create a circle with radius 25
10        SimpleCircle circle2 = new SimpleCircle(25);
11        System.out.println("The area of the circle of radius "
12            + circle2.radius + " is " + circle2.getArea());
13
14        // Create a circle with radius 125
15        SimpleCircle circle3 = new SimpleCircle(125);
16        System.out.println("The area of the circle of radius "
17            + circle3.radius + " is " + circle3.getArea());
18
19        // Modify circle radius
20        circle2.radius = 100; // or circle2.setRadius(100)
21        System.out.println("The area of the circle of radius "
22            + circle2.radius + " is " + circle2.getArea());
23    }

```

main class

main method

create object

create object

create object

```

24 }
25
26 // Define the circle class with two constructors
27 class SimpleCircle {
28     double radius;
29
30     /** Construct a circle with radius 1 */
31     SimpleCircle() {
32         radius = 1;
33     }
34
35     /** Construct a circle with a specified radius */
36     SimpleCircle(double newRadius) {
37         radius = newRadius;
38     }
39
40     /** Return the area of this circle */
41     double getArea() {
42         return radius * radius * Math.PI;
43     }
44
45     /** Return the perimeter of this circle */
46     double getPerimeter() {
47         return 2 * radius * Math.PI;
48     }
49
50     /** Set a new radius for this circle */
51     void setRadius(double newRadius) {
52         radius = newRadius;
53     }
54 }

```

class SimpleCircle
data field
no-arg constructor
second constructor
getArea
getPerimeter
setRadius

```

The area of the circle of radius 1.0 is 3.141592653589793
The area of the circle of radius 25.0 is 1963.4954084936207
The area of the circle of radius 125.0 is 49087.385212340516
The area of the circle of radius 100.0 is 31415.926535897932

```



The program contains two classes. The first of these, `TestSimpleCircle`, is the main class. Its sole purpose is to test the second class, `SimpleCircle`. Such a program that uses the class is often referred to as a *client* of the class. When you run the program, the Java runtime system invokes the `main` method in the main class.

client

You can put the two classes into one file, but only one class in the file can be a *public class*. Furthermore, the public class must have the same name as the file name. Therefore, the file name is `TestSimpleCircle.java`, since `TestSimpleCircle` is public. Each class in the source code is compiled into a `.class` file. When you compile `TestSimpleCircle.java`, two class files `TestSimpleCircle.class` and `SimpleCircle.class` are generated, as shown in Figure 8.5.

public class

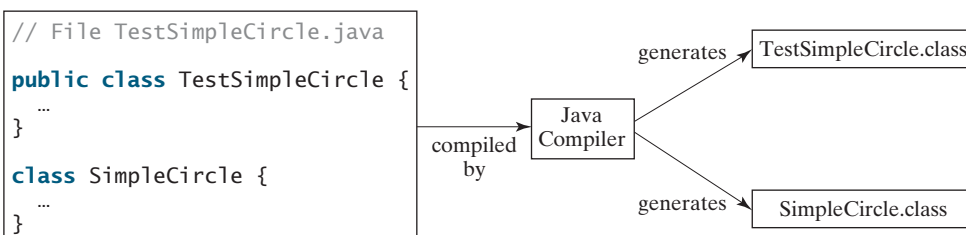


FIGURE 8.5 Each class in the source code file is compiled into a `.class` file.

The main class contains the `main` method (line 3) that creates three objects. As in creating an array, the `new` operator is used to create an object from the constructor. `new SimpleCircle()` creates an object with radius `1` (line 5), `new SimpleCircle(25)` creates an object with radius `25` (line 10), and `new SimpleCircle(125)` creates an object with radius `125` (line 15).

These three objects (referenced by `circle1`, `circle2`, and `circle3`) have different data but the same methods. Therefore, you can compute their respective areas by using the `getArea()` method. The data fields can be accessed via the reference of the object using `circle1.radius`, `circle2.radius`, and `circle3.radius`, respectively. The object can invoke its method via the reference of the object using `circle1.getArea()`, `circle2.getArea()`, and `circle3.getArea()`, respectively.

These three objects are independent. The radius of `circle2` is changed to `100` in line 20. The object's new radius and area are displayed in lines 21–22.

There are many ways to write Java programs. For instance, you can combine the two classes in the example into one, as shown in Listing 8.2.

LISTING 8.2 SimpleCircle.java

```

1  public class SimpleCircle {
2      /** Main method */
3      public static void main(String[] args) {
4          // Create a circle with radius 1
5          SimpleCircle circle1 = new SimpleCircle();
6          System.out.println("The area of the circle of radius "
7              + circle1.radius + " is " + circle1.getArea());
8
9          // Create a circle with radius 25
10         SimpleCircle circle2 = new SimpleCircle(25);
11         System.out.println("The area of the circle of radius "
12             + circle2.radius + " is " + circle2.getArea());
13
14         // Create a circle with radius 125
15         SimpleCircle circle3 = new SimpleCircle(125);
16         System.out.println("The area of the circle of radius "
17             + circle3.radius + " is " + circle3.getArea());
18
19         // Modify circle radius
20         circle2.radius = 100;
21         System.out.println("The area of the circle of radius "
22             + circle2.radius + " is " + circle2.getArea());
23     }
24
25     data field
26     double radius;
27
28     no-arg constructor
29     /** Construct a circle with radius 1 */
30     SimpleCircle() {
31         radius = 1;
32     }
33
34     second constructor
35     /** Construct a circle with a specified radius */
36     SimpleCircle(double newRadius) {
37         radius = newRadius;
38     }
39
40     method
41     /** Return the area of this circle */
42     double getArea() {
43         return radius * radius * Math.PI;
44     }
45 }

```



```

42  /** Return the perimeter of this circle */
43  double getPerimeter() {
44      return 2 * radius * Math.PI;
45  }
46
47  /** Set a new radius for this circle */
48  void setRadius(double newRadius) {
49      radius = newRadius;
50  }
51  }

```

Since the combined class has a `main` method, it can be executed by the Java interpreter. The `main` method is the same as in Listing 8.1. This demonstrates that you can test a class by simply adding a `main` method in the same class.

As another example, consider television sets. Each TV is an object with states (current channel, current volume level, power on or off) and behaviors (change channels, adjust volume, turn on/off). You can use a class to model TV sets. The UML diagram for the class is shown in Figure 8.6.

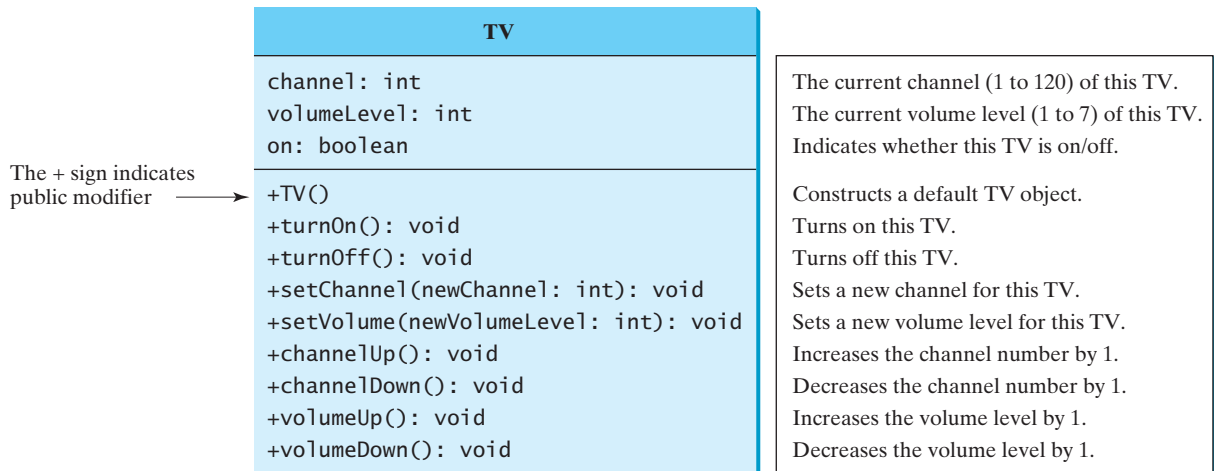


FIGURE 8.6 The TV class models TV sets.

Listing 8.3 gives a program that defines the `TV` class.

LISTING 8.3 TV.java

```

1  public class TV {
2      int channel = 1; // Default channel is 1
3      int volumeLevel = 1; // Default volume level is 1
4      boolean on = false; // TV is off
5
6      public TV() {
7      }
8
9      public void turnOn() {
10         on = true;
11     }
12
13     public void turnOff() {

```

data fields

constructor

turn on TV

turn off TV

```

14     on = false;
15 }
16
set a new channel 17     public void setChannel(int newChannel) {
18         if (on && newChannel >= 1 && newChannel <= 120)
19             channel = newChannel;
20     }
21
set a new volume 22     public void setVolume(int newVolumeLevel) {
23         if (on && newVolumeLevel >= 1 && newVolumeLevel <= 7)
24             volumeLevel = newVolumeLevel;
25     }
26
increase channel 27     public void channelUp() {
28         if (on && channel < 120)
29             channel++;
30     }
31
decrease channel 32     public void channelDown() {
33         if (on && channel > 1)
34             channel--;
35     }
36
increase volume 37     public void volumeUp() {
38         if (on && volumeLevel < 7)
39             volumeLevel++;
40     }
41
decrease volume 42     public void volumeDown() {
43         if (on && volumeLevel > 1)
44             volumeLevel--;
45     }
46 }

```

The constructor and methods in the **TV** class are defined public so they can be accessed from other classes. Note that the channel and volume level are not changed if the TV is not on. Before either of these is changed, its current value is checked to ensure that it is within the correct range.

Listing 8.4 gives a program that uses the **TV** class to create two objects.

LISTING 8.4 TestTV.java

```

1     public class TestTV {
2         public static void main(String[] args) {
3             TV tv1 = new TV();
4             tv1.turnOn();
5             tv1.setChannel(30);
6             tv1.setVolume(3);
7
8             TV tv2 = new TV();
9             tv2.turnOn();
10            tv2.channelUp();
11            tv2.channelUp();
12            tv2.volumeUp();
13
14            System.out.println("tv1's channel is " + tv1.channel
15                + " and volume level is " + tv1.volumeLevel);
16            System.out.println("tv2's channel is " + tv2.channel
17                + " and volume level is " + tv2.volumeLevel);
18        }
19    }

```

```
tv1's channel is 30 and volume level is 3
tv2's channel is 3 and volume level is 2
```



The program creates two objects in lines 3 and 8 and invokes the methods on the objects to perform actions for setting channels and volume levels and for increasing channels and volumes. The program displays the state of the objects in lines 14–17. The methods are invoked using syntax such as `tv1.turnOn()` (line 4). The data fields are accessed using syntax such as `tv1.channel` (line 14).

These examples have given you a glimpse of classes and objects. You may have many questions regarding constructors, objects, reference variables, accessing data fields, and invoking object's methods. The sections that follow discuss these issues in detail.

- 8.1 Describe the relationship between an object and its defining class.
- 8.2 How do you define a class?
- 8.3 How do you declare an object's reference variable?
- 8.4 How do you create an object?



MyProgrammingLab™

8.4 Constructing Objects Using Constructors

A constructor is invoked to create an object using the `new` operator.

Constructors are a special kind of method. They have three peculiarities:

- A constructor must have the same name as the class itself.
- Constructors do not have a return type—not even `void`.
- Constructors are invoked using the `new` operator when an object is created. Constructors play the role of initializing objects.

The constructor has exactly the same name as its defining class. Like regular methods, constructors can be overloaded (i.e., multiple constructors can have the same name but different signatures), making it easy to construct objects with different initial data values.

It is a common mistake to put the `void` keyword in front of a constructor. For example,

```
public void Circle() {
}
```

In this case, `Circle()` is a method, not a constructor.

Constructors are used to construct objects. To construct an object from a class, invoke a constructor of the class using the `new` operator, as follows:

```
new ClassName(arguments);
```

For example, `new Circle()` creates an object of the `Circle` class using the first constructor defined in the `Circle` class, and `new Circle(25)` creates an object using the second constructor defined in the `Circle` class.

A class normally provides a constructor without arguments (e.g., `Circle()`). Such a constructor is referred to as a *no-arg* or *no-argument constructor*.

A class may be defined without constructors. In this case, a public no-arg constructor with an empty body is implicitly defined in the class. This constructor, called a *default constructor*, is provided automatically *only if no constructors are explicitly defined in the class*.

- 8.5 What are the differences between constructors and methods?
- 8.6 When will a class have a default constructor?



constructor's name

no return type

new operator

overloaded constructors

no void

constructing objects

no-arg constructor

default constructor



MyProgrammingLab™

8.5 Accessing Objects via Reference Variables



An object's data and methods can be accessed through the dot (.) operator via the object's reference variable.

Newly created objects are allocated in the memory. They can be accessed via reference variables.

8.5.1 Reference Variables and Reference Types

reference variable

Objects are accessed via the object's *reference variables*, which contain references to the objects. Such variables are declared using the following syntax:

```
ClassName objectRefVar;
```

reference type

A class is essentially a programmer-defined type. A class is a *reference type*, which means that a variable of the class type can reference an instance of the class. The following statement declares the variable `myCircle` to be of the `Circle` type:

```
Circle myCircle;
```

The variable `myCircle` can reference a `Circle` object. The next statement creates an object and assigns its reference to `myCircle`:

```
myCircle = new Circle();
```

You can write a single statement that combines the declaration of an object reference variable, the creation of an object, and the assigning of an object reference to the variable with the following syntax:

```
ClassName objectRefVar = new ClassName();
```

Here is an example:

```
Circle myCircle = new Circle();
```

The variable `myCircle` holds a reference to a `Circle` object.

object vs. object reference variable



Note

An object reference variable that appears to hold an object actually contains a reference to that object. Strictly speaking, an object reference variable and an object are different, but most of the time the distinction can be ignored. Therefore, it is fine, for simplicity, to say that `myCircle` is a `Circle` object rather than use the longer-winded description that `myCircle` is a variable that contains a reference to a `Circle` object.

array object



Note

Arrays are treated as objects in Java. Arrays are created using the `new` operator. An array variable is actually a variable that contains a reference to an array.

8.5.2 Accessing an Object's Data and Methods

dot operator (.)

In OOP terminology, an object's member refers to its data fields and methods. After an object is created, its data can be accessed and its methods invoked using the *dot operator* (`.`), also known as the *object member access operator*:

- `objectRefVar.dataField` references a data field in the object.
- `objectRefVar.method(arguments)` invokes a method on the object.

For example, `myCircle.radius` references the `radius` in `myCircle`, and `myCircle.getArea()` invokes the `getArea` method on `myCircle`. Methods are invoked as operations on objects.

The data field `radius` is referred to as an *instance variable*, because it is dependent on a specific instance. For the same reason, the method `getArea` is referred to as an *instance method*, because you can invoke it only on a specific instance. The object on which an instance method is invoked is called a *calling object*.

instance variable
instance method
calling object



Caution

Recall that you use `Math.methodName(arguments)` (e.g., `Math.pow(3, 2.5)`) to invoke a method in the `Math` class. Can you invoke `getArea()` using `Circle.getArea()`? The answer is no. All the methods in the `Math` class are static methods, which are defined using the `static` keyword. However, `getArea()` is an instance method, and thus nonstatic. It must be invoked from an object using `objectRefVar.methodName(arguments)` (e.g., `myCircle.getArea()`). Further explanation is given in Section 8.7, Static Variables, Constants, and Methods.

invoking methods



Note

Usually you create an object and assign it to a variable, and then later you can use the variable to reference the object. Occasionally an object does not need to be referenced later. In this case, you can create an object without explicitly assigning it to a variable using the syntax:

```
new Circle();
```

or

```
System.out.println("Area is " + new Circle(5).getArea());
```

The former statement creates a `Circle` object. The latter creates a `Circle` object and invokes its `getArea` method to return its area. An object created in this way is known as an *anonymous object*.

anonymous object

8.5.3 Reference Data Fields and the `null` Value

The data fields can be of reference types. For example, the following `Student` class contains a data field `name` of the `String` type. `String` is a predefined Java class.

reference data fields

```
class Student {
    String name; // name has the default value null
    int age; // age has the default value 0
    boolean isScienceMajor; // isScienceMajor has default value false
    char gender; // gender has default value '\u0000'
}
```

If a data field of a reference type does not reference any object, the data field holds a special Java value, `null`. `null` is a literal just like `true` and `false`. While `true` and `false` are Boolean literals, `null` is a literal for a reference type.

null value

The default value of a data field is `null` for a reference type, `0` for a numeric type, `false` for a `boolean` type, and `\u0000` for a `char` type. However, Java assigns no default value to a local variable inside a method. The following code displays the default values of the data fields `name`, `age`, `isScienceMajor`, and `gender` for a `Student` object:

default field values

```
class Test {
    public static void main(String[] args) {
        Student student = new Student();
        System.out.println("name? " + student.name);
    }
}
```

```

System.out.println("age? " + student.age);
System.out.println("isScienceMajor? " + student.isScienceMajor);
System.out.println("gender? " + student.gender);
}
}

```

The following code has a compile error, because the local variables `x` and `y` are not initialized:

```

class Test {
    public static void main(String[] args) {
        int x; // x has no default value
        String y; // y has no default value
        System.out.println("x is " + x);
        System.out.println("y is " + y);
    }
}

```

NullPointerException



Caution

NullPointerException is a common runtime error. It occurs when you invoke a method on a reference variable with a **null** value. Make sure you assign an object reference to the variable before invoking the method through the reference variable.

8.5.4 Differences between Variables of Primitive Types and Reference Types

Every variable represents a memory location that holds a value. When you declare a variable, you are telling the compiler what type of value the variable can hold. For a variable of a primitive type, the value is of the primitive type. For a variable of a reference type, the value is a reference to where an object is located. For example, as shown in Figure 8.7, the value of `int` variable `i` is `int` value `1`, and the value of `Circle` object `c` holds a reference to where the contents of the `Circle` object are stored in memory.

When you assign one variable to another, the other variable is set to the same value. For a variable of a primitive type, the real value of one variable is assigned to the other variable. For a variable of a reference type, the reference of one variable is assigned to the other variable. As shown in Figure 8.8, the assignment statement `i = j` copies the contents of `j` into `i` for

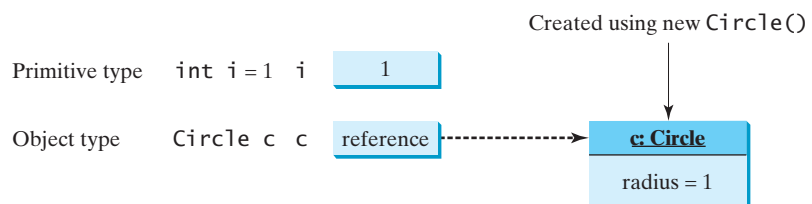


FIGURE 8.7 A variable of a primitive type holds a value of the primitive type, and a variable of a reference type holds a reference to where an object is stored in memory.

Primitive type assignment `i = j`

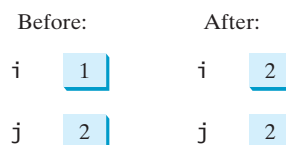


FIGURE 8.8 Primitive variable `j` is copied to variable `i`.

primitive variables. As shown in Figure 8.9, the assignment statement `c1 = c2` copies the reference of `c2` into `c1` for reference variables. After the assignment, variables `c1` and `c2` refer to the same object.

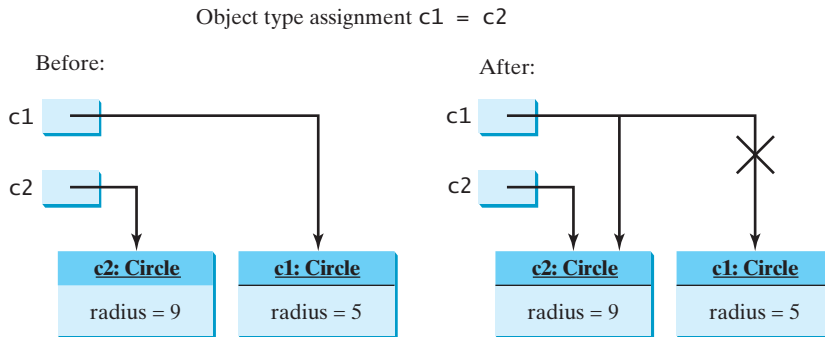


FIGURE 8.9 Reference variable `c2` is copied to variable `c1`.



Note

As illustrated in Figure 8.9, after the assignment statement `c1 = c2`, `c1` points to the same object referenced by `c2`. The object previously referenced by `c1` is no longer useful and therefore is now known as *garbage*. Garbage occupies memory space, so the Java runtime system detects garbage and automatically reclaims the space it occupies. This process is called *garbage collection*.

garbage

garbage collection



Tip

If you know that an object is no longer needed, you can explicitly assign `null` to a reference variable for the object. The JVM will automatically collect the space if the object is not referenced by any reference variable.

- 8.7** Which operator is used to access a data field or invoke a method from an object?
- 8.8** What is an anonymous object?
- 8.9** What is `NullPointerException`?
- 8.10** Is an array an object or a primitive type value? Can an array contain elements of an object type as well as a primitive type? Describe the default value for the elements of an array.
- 8.11** What is wrong with each of the following programs?



MyProgrammingLab™

```
1 public class ShowErrors {
2     public static void main(String[] args) {
3         ShowErrors t = new ShowErrors(5);
4     }
5 }
```

(a)

```
1 public class ShowErrors {
2     public static void main(String[] args) {
3         ShowErrors t = new ShowErrors();
4         t.x();
5     }
6 }
```

(b)

```

1 public class ShowErrors {
2     public void method1() {
3         Circle c;
4         System.out.println("What is radius "
5             + c.getRadius());
6         c = new Circle();
7     }
8 }

```

(c)

```

1 public class ShowErrors {
2     public static void main(String[] args) {
3         C c = new C(5.0);
4         System.out.println(c.value);
5     }
6 }
7
8 class C {
9     int value = 2;
10 }

```

(d)

8.12 What is wrong in the following code?

```

1 class Test {
2     public static void main(String[] args) {
3         A a = new A();
4         a.print();
5     }
6 }
7
8 class A {
9     String s;
10
11     A(String newS) {
12         s = newS;
13     }
14
15     public void print() {
16         System.out.print(s);
17     }
18 }

```

8.13 What is the printout of the following code?

```

public class A {
    private boolean x;

    public static void main(String[] args) {
        A a = new A();
        System.out.println(a.x);
    }
}

```

8.6 Using Classes from the Java Library



The Java API contains a rich set of classes for developing Java programs.

Listing 8.1 defined the `SimpleCircle` class and created objects from the class. You will frequently use the classes in the Java library to develop programs. This section gives some examples of the classes in the Java library.

8.6.1 The `Date` Class

In Listing 2.6, `ShowCurrentTime.java`, you learned how to obtain the current time using `System.currentTimeMillis()`. You used the division and remainder operators to extract

the current second, minute, and hour. Java provides a system-independent encapsulation of date and time in the `java.util.Date` class, as shown in Figure 8.10.

`java.util.Date` class

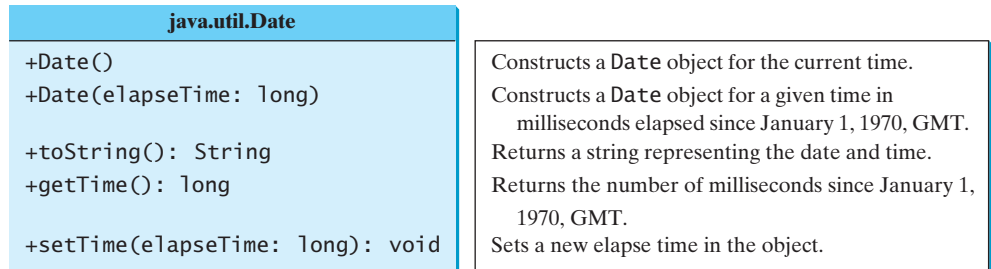


FIGURE 8.10 A `Date` object represents a specific date and time.

You can use the no-arg constructor in the `Date` class to create an instance for the current date and time, the `getTime()` method to return the elapsed time since January 1, 1970, GMT, and the `toString()` method to return the date and time as a string. For example, the following code

```
java.util.Date date = new java.util.Date();
System.out.println("The elapsed time since Jan 1, 1970 is " +
    date.getTime() + " milliseconds");
System.out.println(date.toString());
```

create object
get elapsed time
invoke toString

displays the output like this:

```
The elapsed time since Jan 1, 1970 is 1324903419651 milliseconds
Mon Dec 26 07:43:39 EST 2011
```

The `Date` class has another constructor, `Date(long elapseTime)`, which can be used to construct a `Date` object for a given time in milliseconds elapsed since January 1, 1970, GMT.

8.6.2 The `Random` Class

You have used `Math.random()` to obtain a random `double` value between `0.0` and `1.0` (excluding `1.0`). Another way to generate random numbers is to use the `java.util.Random` class, as shown in Figure 8.11, which can generate a random `int`, `long`, `double`, `float`, and `boolean` value.

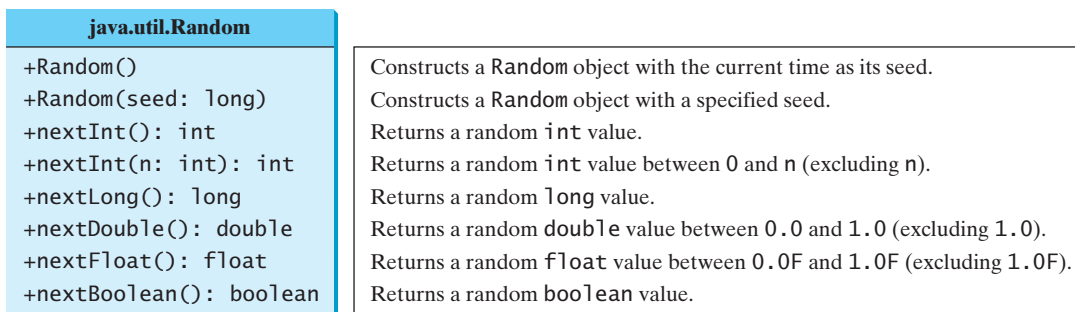


FIGURE 8.11 A `Random` object can be used to generate random values.

When you create a **Random** object, you have to specify a seed or use the default seed. A seed is a number used to initialize a random number generator. The no-arg constructor creates a **Random** object using the current elapsed time as its seed. If two **Random** objects have the same seed, they will generate identical sequences of numbers. For example, the following code creates two **Random** objects with the same seed, **3**.

```
Random random1 = new Random(3);
System.out.print("From random1: ");
for (int i = 0; i < 10; i++)
    System.out.print(random1.nextInt(1000) + " ");

Random random2 = new Random(3);
System.out.print("\nFrom random2: ");
for (int i = 0; i < 10; i++)
    System.out.print(random2.nextInt(1000) + " ");
```

The code generates the same sequence of random **int** values:

```
From random1: 734 660 210 581 128 202 549 564 459 961
From random2: 734 660 210 581 128 202 549 564 459 961
```

same sequence



Note

The ability to generate the same sequence of random values is useful in software testing and many other applications. In software testing, often you need to reproduce the test cases from a fixed sequence of random numbers.

8.6.3 Displaying GUI Components



Pedagogical Note

Graphical user interface (GUI) components are good examples for teaching OOP. Simple GUI examples are introduced here for this purpose. The full introduction to GUI programming begins with Chapter 12, GUI Basics.

When you develop programs to create graphical user interfaces, you will use Java classes such as **JFrame**, **JButton**, **JRadioButton**, **JComboBox**, and **JList** to create frames, buttons, radio buttons, combo boxes, lists, and so on. Listing 8.5 is an example that creates two windows using the **JFrame** class. The output of the program is shown in Figure 8.12.



FIGURE 8.12 The program creates two windows using the **JFrame** class.

LISTING 8.5 TestFrame.java

```
1 import javax.swing.JFrame;
2
3 public class TestFrame {
4     public static void main(String[] args) {
5         JFrame frame1 = new JFrame();
6         frame1.setTitle("Window 1");
7         frame1.setSize(200, 150);
8         frame1.setLocation(200, 100);
9         frame1.setDefaultCloseOperation(JFrame.EXIT_ON_CLOSE);
10        frame1.setVisible(true);
```

create an object
invoke a method

```

11
12     JFrame frame2 = new JFrame();
13     frame2.setTitle("Window 2");
14     frame2.setSize(200, 150);
15     frame2.setLocation(410, 100);
16     frame2.setDefaultCloseOperation(JFrame.EXIT_ON_CLOSE);
17     frame2.setVisible(true);
18 }
19 }

```

create an object
invoke a method

This program creates two objects of the `JFrame` class (lines 5, 12) and then uses the methods `setTitle`, `setSize`, `setLocation`, `setDefaultCloseOperation`, and `setVisible` to set the properties of the objects. The `setTitle` method sets a title for the window (lines 6, 13). The `setSize` method sets the window's width and height (lines 7, 14). The `setLocation` method specifies the location of the window's upper-left corner (lines 8, 15). The `setDefaultCloseOperation` method terminates the program when the frame is closed (lines 9, 16). The `setVisible` method displays the window.

You can add graphical user interface components, such as buttons, labels, text fields, check boxes, and combo boxes to the window. The components are defined using classes. Listing 8.6 gives an example of creating a graphical user interface, as shown in Figure 8.1.

LISTING 8.6 GUIComponents.java

```

1  import javax.swing.*;
2
3  public class GUIComponents {
4      public static void main(String[] args) {
5          // Create a button with text OK
6          JButton jbtOK = new JButton("OK");
7
8          // Create a button with text Cancel
9          JButton jbtCancel = new JButton("Cancel");
10
11         // Create a label with text "Enter your name: "
12         JLabel lblName = new JLabel("Enter your name: ");
13
14         // Create a text field with text "Type Name Here"
15         JTextField jtfName = new JTextField("Type Name Here");
16
17         // Create a check box with text Bold
18         JCheckBox jchkBold = new JCheckBox("Bold");
19
20         // Create a check box with text Italic
21         JCheckBox jchkItalic = new JCheckBox("Italic");
22
23         // Create a radio button with text Red
24         JRadioButton jrbRed = new JRadioButton("Red");
25
26         // Create a radio button with text Yellow
27         JRadioButton jrbYellow = new JRadioButton("Yellow");
28
29         // Create a combo box with several choices
30         JComboBox jcbColor = new JComboBox(new String[]{"Freshman",
31             "Sophomore", "Junior", "Senior"});
32
33         // Create a panel to group components
34         JPanel panel = new JPanel();
35         panel.add(jbtOK); // Add the OK button to the panel
36         panel.add(jbtCancel); // Add the Cancel button to the panel

```

create a button
create a button
create a label
create a text field
create a check box
create a check box
create a radio button
create a radio button
create a combo box
create a panel
add to panel



VideoNote
Use classes

```

37     panel.add(jlblName); // Add the label to the panel
38     panel.add(jtfName); // Add the text field to the panel
39     panel.add(jchkBold); // Add the check box to the panel
40     panel.add(jchkItalic); // Add the check box to the panel
41     panel.add(jrbRed); // Add the radio button to the panel
42     panel.add(jrbYellow); // Add the radio button to the panel
43     panel.add(jcboColor); // Add the combo box to the panel
44
45     JFrame frame = new JFrame(); // Create a frame
46     frame.add(panel); // Add the panel to the frame
47     frame.setTitle("Show GUI Components");
48     frame.setSize(450, 100);
49     frame.setLocation(200, 100);
50     frame.setDefaultCloseOperation(JFrame.EXIT_ON_CLOSE);
51     frame.setVisible(true);
52 }
53 }

```

create a frame
add panel to frame

display frame

This program creates GUI objects using the classes `JButton`, `JLabel`, `JTextField`, `JCheckBox`, `JRadioButton`, and `JComboBox` (lines 6–31). Then, using the `JPanel` class (line 34), it then creates a panel object and adds the button, label, text field, check box, radio button, and combo box to it (lines 35–43). The program then creates a frame and adds the panel to the frame (line 45). The frame is displayed in line 51.



8.14 How do you create a `Date` for the current time? How do you display the current time?

8.15 How do you create a `JFrame`, set a title in a frame, and display a frame?

8.16 Which packages contain the classes `Date`, `JFrame`, `JOptionPane`, `System`, and `Math`?

MyProgrammingLab™



8.7 Static Variables, Constants, and Methods

A static variable is shared by all objects of the class. A static method cannot access instance members of the class.



VideoNote

Static vs. instance
instance variable

The data field `radius` in the circle class is known as an *instance variable*. An instance variable is tied to a specific instance of the class; it is not shared among objects of the same class. For example, suppose that you create the following objects:

```

Circle circle1 = new Circle();
Circle circle2 = new Circle(5);

```

The `radius` in `circle1` is independent of the `radius` in `circle2` and is stored in a different memory location. Changes made to `circle1`'s `radius` do not affect `circle2`'s `radius`, and vice versa.

static variable

If you want all the instances of a class to share data, use *static variables*, also known as *class variables*. Static variables store values for the variables in a common memory location. Because of this common location, if one object changes the value of a static variable, all objects of the same class are affected. Java supports static methods as well as static variables. *Static methods* can be called without creating an instance of the class.

static method

Let's modify the `Circle` class by adding a static variable `numberOfObjects` to count the number of circle objects created. When the first object of this class is created, `numberOfObjects` is `1`. When the second object is created, `numberOfObjects` becomes `2`. The UML of the new circle class is shown in Figure 8.13. The `Circle` class defines the instance variable `radius` and the static variable `numberOfObjects`, the instance methods `getRadius`, `setRadius`, and `getArea`, and the static method `getNumberOfObjects`. (Note that static variables and methods are underlined in the UML class diagram.)

UML Notation:

underline: static variables or methods

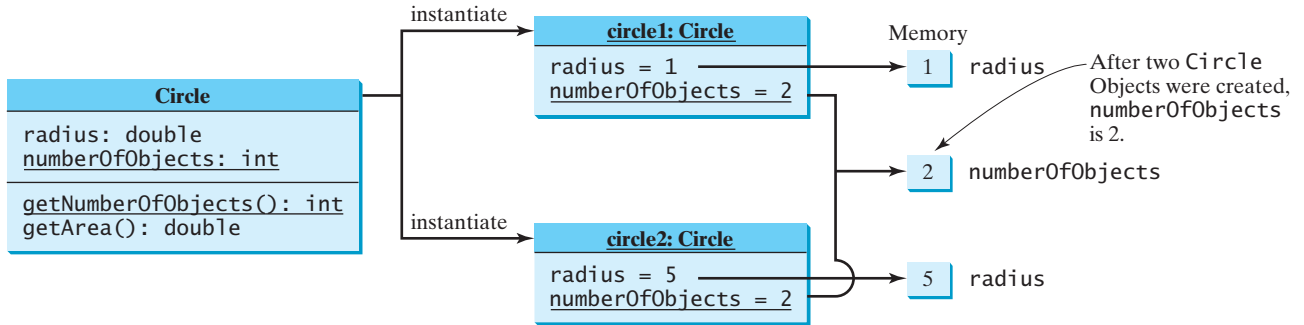


FIGURE 8.13 Instance variables belong to the instances and have memory storage independent of one another. Static variables are shared by all the instances of the same class.

To declare a static variable or define a static method, put the modifier **static** in the variable or method declaration. The static variable `numberOfObjects` and the static method `getNumberOfObjects()` can be declared as follows:

```
static int numberOfObjects;                                declare static variable
static int getNumberOfObjects() {                          define static method
    return numberOfObjects;
}
```

Constants in a class are shared by all objects of the class. Thus, constants should be declared as **final static**. For example, the constant `PI` in the `Math` class is defined as:

```
final static double PI = 3.14159265358979323846;
```

The new circle class, named `CircleWithStaticMembers`, is defined in Listing 8.7:

LISTING 8.7 CircleWithStaticMembers.java

```
1 public class CircleWithStaticMembers {
2     /** The radius of the circle */
3     double radius;
4
5     /** The number of objects created */
6     static int numberOfObjects = 0;                                static variable
7
8     /** Construct a circle with radius 1 */
9     CircleWithStaticMembers() {
10        radius = 1;
11        numberOfObjects++;                                       increase by 1
12    }
13
14    /** Construct a circle with a specified radius */
15    CircleWithStaticMembers(double newRadius) {
16        radius = newRadius;
17        numberOfObjects++;                                       increase by 1
18    }
19
20    /** Return numberOfObjects */
21    static int getNumberOfObjects() {                            static method
22        return numberOfObjects;
23    }
24}
```

```

25  /** Return the area of this circle */
26  double getArea() {
27      return radius * radius * Math.PI;
28  }
29  }

```

Method `getNumberOfObjects()` in `CircleWithStaticMembers` is a static method. Other examples of static methods are `showMessageDialog` and `showInputDialog` in the `JOptionPane` class and all the methods in the `Math` class. The `main` method is static, too.

Instance methods (e.g., `getArea()`) and instance data (e.g., `radius`) belong to instances and can be used only after the instances are created. They are accessed via a reference variable. Static methods (e.g., `getNumberOfObjects()`) and static data (e.g., `numberOfObjects`) can be accessed from a reference variable or from their class name.

The program in Listing 8.8 demonstrates how to use instance and static variables and methods and illustrates the effects of using them.

LISTING 8.8 TestCircleWithStaticMembers.java

```

1  public class TestCircleWithStaticMembers {
2      /** Main method */
3      public static void main(String[] args) {
4          System.out.println("Before creating objects");
5          System.out.println("The number of Circle objects is " +
6              CircleWithStaticMembers.numberOfObjects);
7
8          // Create c1
9          CircleWithStaticMembers c1 = new CircleWithStaticMembers();
10
11         // Display c1 BEFORE c2 is created
12         System.out.println("\nAfter creating c1");
13         System.out.println("c1: radius (" + c1.radius +
14             ") and number of Circle objects (" +
15             c1.numberOfObjects + ")");
16
17         // Create c2
18         CircleWithStaticMembers c2 = new CircleWithStaticMembers(5);
19
20         // Modify c1
21         c1.radius = 9;
22
23         // Display c1 and c2 AFTER c2 was created
24         System.out.println("\nAfter creating c2 and modifying c1");
25         System.out.println("c1: radius (" + c1.radius +
26             ") and number of Circle objects (" +
27             c1.numberOfObjects + ")");
28         System.out.println("c2: radius (" + c2.radius +
29             ") and number of Circle objects (" +
30             c2.numberOfObjects + ")");
31     }
32 }

```

static variable

instance variable

static variable

instance variable

static variable

static variable



```

Before creating objects
The number of Circle objects is 0
After creating c1
c1: radius (1.0) and number of Circle objects (1)
After creating c2 and modifying c1
c1: radius (9.0) and number of Circle objects (2)
c2: radius (5.0) and number of Circle objects (2)

```

When you compile `TestCircleWithStaticMembers.java`, the Java compiler automatically compiles `CircleWithStaticMembers.java` if it has not been compiled since the last change.

Static variables and methods can be accessed without creating objects. Line 6 displays the number of objects, which is `0`, since no objects have been created.

The `main` method creates two circles, `c1` and `c2` (lines 9, 18). The instance variable `radius` in `c1` is modified to become `9` (line 21). This change does not affect the instance variable `radius` in `c2`, since these two instance variables are independent. The static variable `numberOfObjects` becomes `1` after `c1` is created (line 9), and it becomes `2` after `c2` is created (line 18).

Note that `PI` is a constant defined in `Math`, and `Math.PI` references the constant. `c1.numberOfObjects` (line 27) and `c2.numberOfObjects` (line 30) are better replaced by `CircleWithStaticMembers.numberOfObjects`. This improves readability, because other programmers can easily recognize the static variable. You can also replace `CircleWithStaticMembers.numberOfObjects` with `CircleWithStaticMembers.getNumberOfObjects()`.

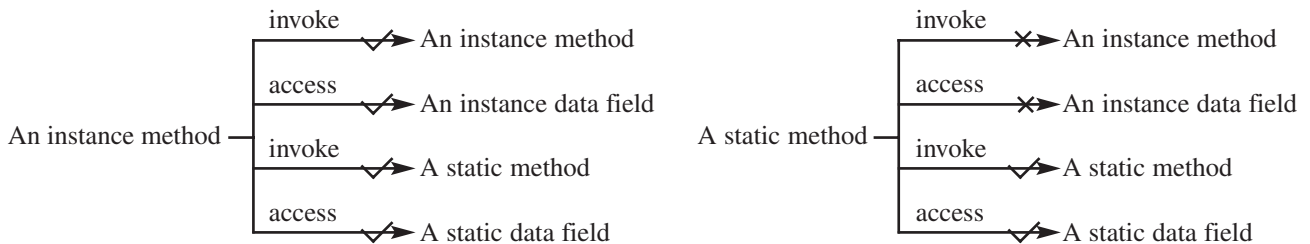


Tip

Use `ClassName.methodName(arguments)` to invoke a static method and `ClassName.staticVariable` to access a static variable. This improves readability, because other programmers can easily recognize the static method and data in the class.

use class name

An instance method can invoke an instance or static method and access an instance or static data field. A static method can invoke a static method and access a static data field. However, a static method cannot invoke an instance method or access an instance data field, since static methods and static data fields don't belong to a particular object. The relationship between static and instance members is summarized in the following diagram:



For example, the following code is wrong.

```

1  public class A {
2      int i = 5;
3      static int k = 2;
4
5      public static void main(String[] args) {
6          int j = i; // Wrong because i is an instance variable
7          m1(); // Wrong because m1() is an instance method
8      }
9
10     public void m1() {
11         // Correct since instance and static variables and methods
12         // can be used in an instance method
13         i = i + k + m2(i, k);
14     }
15
16     public static int m2(int i, int j) {
17         return (int)(Math.pow(i, j));
18     }
19 }

```

Note that if you replace the preceding code with the following new code, the program would be fine, because the instance data field `i` and method `m1` are now accessed from an object `a` (lines 7–8):

```

1 public class A {
2     int i = 5;
3     static int k = 2;
4
5     public static void main(String[] args) {
6         A a = new A();
7         int j = a.i; // OK, a.i accesses the object's instance variable
8         a.m1(); // OK. a.m1() invokes the object's instance method
9     }
10
11    public void m1() {
12        i = i + k + m2(i, k);
13    }
14
15    public static int m2(int i, int j) {
16        return (int)(Math.pow(i, j));
17    }
18 }

```

instance or static?



Design Guide

How do you decide whether a variable or method should be an instance one or a static one? A variable or method that is dependent on a specific instance of the class should be an instance variable or method. A variable or method that is not dependent on a specific instance of the class should be a static variable or method. For example, every circle has its own radius, so the radius is dependent on a specific circle. Therefore, `radius` is an instance variable of the `Circle` class. Since the `getArea` method is dependent on a specific circle, it is an instance method. None of the methods in the `Math` class, such as `random`, `pow`, `sin`, and `cos`, is dependent on a specific instance. Therefore, these methods are static methods. The `main` method is static and can be invoked directly from a class.

common design error



Caution

It is a common design error to define an instance method that should have been defined as static. For example, the method `factorial(int n)` should be defined as static, as shown next, because it is independent of any specific instance.

```

public class Test {
    public int factorial(int n) {
        int result = 1;
        for (int i = 1; i <= n; i++)
            result *= i;
        return result;
    }
}

```

(a) Wrong design

```

public class Test {
    public static int factorial(int n) {
        int result = 1;
        for (int i = 1; i <= n; i++)
            result *= i;
        return result;
    }
}

```

(b) Correct design




```
public class F {
    int i;
    static String s;

    void imethod() {
    }

    static void smethod() {
    }
}
```

(a)

```
System.out.println(f.i);
System.out.println(f.s);
f.imethod();
f.smethod();
System.out.println(F.i);
System.out.println(F.s);
F.imethod();
F.smethod();
```

(b)

8.18 Add the **static** keyword in the place of **?** if appropriate.

```
public class Test {
    private int count;

    public ? void main(String[] args) {
        ...
    }

    public ? int getCount() {
        return count;
    }

    public ? int factorial(int n) {
        int result = 1;
        for (int i = 1; i <= n; i++)
            result *= i;

        return result;
    }
}
```

8.19 Can you invoke an instance method or reference an instance variable from a static method? Can you invoke a static method or reference a static variable from an instance method? What is wrong in the following code?

```
1 public class C {
2     public static void main(String[] args) {
3         method1();
4     }
5
6     public void method1() {
7         method2();
8     }
9
10    public static void method2() {
11        System.out.println("What is radius " + c.getRadius());
12    }
13
14    Circle c = new Circle();
15 }
```

8.8 Visibility Modifiers

Visibility modifiers can be used to specify the visibility of a class and its members.

You can use the **public** visibility modifier for classes, methods, and data fields to denote that they can be accessed from any other classes. If no visibility modifier is used, then by default the classes, methods, and data fields are accessible by any class in the same package. This is known as *package-private* or *package-access*.



package-private (or package-access)

using packages

**Note**

Packages can be used to organize classes. To do so, you need to add the following line as the first noncomment and nonblank statement in the program:

```
package packageName;
```

If a class is defined without the package statement, it is said to be placed in the *default package*.

Java recommends that you place classes into packages rather using a default package. For simplicity, however, this book uses default packages. For more information on packages, see Supplement III.G, Packages.

In addition to the **public** and default visibility modifiers, Java provides the **private** and **protected** modifiers for class members. This section introduces the **private** modifier. The **protected** modifier will be introduced in Section 11.13, The **protected** Data and Methods.

The **private** modifier makes methods and data fields accessible only from within its own class. Figure 8.14 illustrates how a public, default, and private data field or method in class **C1** can be accessed from a class **C2** in the same package and from a class **C3** in a different package.

<pre>package p1; public class C1 { public int x; int y; private int z; public void m1() { } void m2() { } private void m3() { } }</pre>	<pre>package p1; public class C2 { void aMethod() { C1 o = new C1(); can access o.x; can access o.y; cannot access o.z; can invoke o.m1(); can invoke o.m2(); cannot invoke o.m3(); } }</pre>	<pre>package p2; public class C3 { void aMethod() { C1 o = new C1(); can access o.x; cannot access o.y; cannot access o.z; can invoke o.m1(); cannot invoke o.m2(); cannot invoke o.m3(); } }</pre>
---	---	---

FIGURE 8.14 The private modifier restricts access to its defining class, the default modifier restricts access to a package, and the public modifier enables unrestricted access.

If a class is not defined as public, it can be accessed only within the same package. As shown in Figure 8.15, **C1** can be accessed from **C2** but not from **C3**.

<pre>package p1; class C1 { ... }</pre>	<pre>package p1; public class C2 { can access C1 }</pre>	<pre>package p2; public class C3 { cannot access C1; can access C2; }</pre>
--	---	--

FIGURE 8.15 A nonpublic class has package-access.

inside access

A visibility modifier specifies how data fields and methods in a class can be accessed from outside the class. There is no restriction on accessing data fields and methods from inside the class. As shown in Figure 8.16b, an object **c** of class **C** cannot access its private members, because **c** is in the **Test** class. As shown in Figure 8.16a, an object **c** of class **C** can access its private members, because **c** is defined inside its own class.

```
public class C {
    private boolean x;

    public static void main(String[] args) {
        C c = new C();
        System.out.println(c.x);
        System.out.println(c.convert());
    }

    private int convert() {
        return x ? 1 : -1;
    }
}
```

(a) This is okay because object `c` is used inside the class `C`.

```
public class Test {
    public static void main(String[] args) {
        C c = new C();
        System.out.println(c.x);
        System.out.println(c.convert());
    }
}
```

(b) This is wrong because `x` and `convert` are private in class `C`.

FIGURE 8.16 An object can access its private members if it is defined in its own class.



Caution

The **private** modifier applies only to the members of a class. The **public** modifier can apply to a class or members of a class. Using the modifiers **public** and **private** on local variables would cause a compile error.



Note

In most cases, the constructor should be public. However, if you want to prohibit the user from creating an instance of a class, use a *private constructor*. For example, there is no reason to create an instance from the `Math` class, because all of its data fields and methods are static. To prevent the user from creating objects from the `Math` class, the constructor in `java.lang.Math` is defined as follows:

```
private Math() {
}
```

private constructor

8.9 Data Field Encapsulation

Making data fields private protects data and makes the class easy to maintain.

The data fields `radius` and `numberOfObjects` in the `CircleWithStaticMembers` class in Listing 8.7 can be modified directly (e.g., `c1.radius = 5` or `CircleWithStaticMembers.numberOfObjects = 10`). This is not a good practice—for two reasons:

- First, data may be tampered with. For example, `numberOfObjects` is to count the number of objects created, but it may be mistakenly set to an arbitrary value (e.g., `CircleWithStaticMembers.numberOfObjects = 10`).
- Second, the class becomes difficult to maintain and vulnerable to bugs. Suppose you want to modify the `CircleWithStaticMembers` class to ensure that the radius is nonnegative after other programs have already used the class. You have to change not only the `CircleWithStaticMembers` class but also the programs that use it, because the clients may have modified the radius directly (e.g., `c1.radius = -5`).

To prevent direct modifications of data fields, you should declare the data fields private, using the **private** modifier. This is known as *data field encapsulation*.



VideoNote

Data field encapsulation

data field encapsulation

A private data field cannot be accessed by an object from outside the class that defines the private field. However, a client often needs to retrieve and modify a data field. To make a private data field accessible, provide a *get* method to return its value. To enable a private data field to be updated, provide a *set* method to set a new value.

getter (or accessor)
setter (or mutator)



Note

Colloquially, a **get** method is referred to as a *getter* (or *accessor*), and a **set** method is referred to as a *setter* (or *mutator*).

A **get** method has the following signature:

```
public returnType getPropertyname()
```

boolean accessor

If the **returnType** is **boolean**, the **get** method should be defined as follows by convention:

```
public boolean isPropertyName()
```

A **set** method has the following signature:

```
public void setPropertyName(dataType propertyName)
```

Let's create a new circle class with a private data-field radius and its associated accessor and mutator methods. The class diagram is shown in Figure 8.17. The new circle class, named **CircleWithPrivateDataFields**, is defined in Listing 8.9:

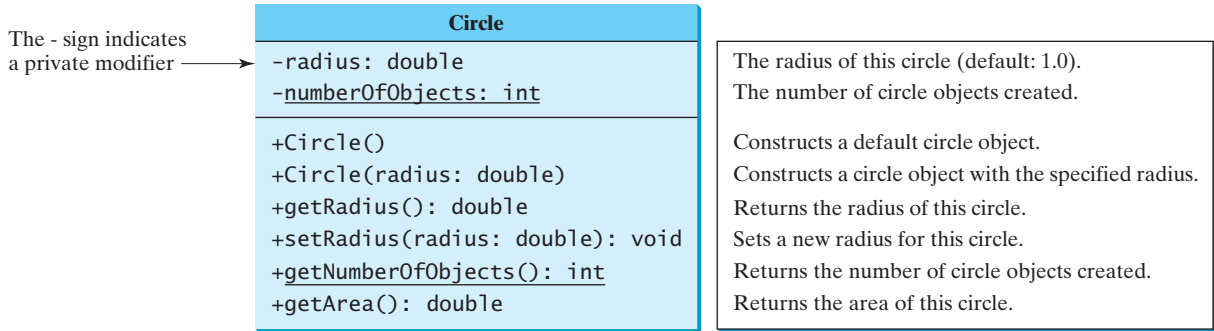


FIGURE 8.17 The **Circle** class encapsulates circle properties and provides get/set and other methods.

LISTING 8.9 CircleWithPrivateDataFields.java

encapsulate radius

encapsulate
numberOfObjects

```

1 public class CircleWithPrivateDataFields {
2     /** The radius of the circle */
3     private double radius = 1;
4
5     /** The number of objects created */
6     private static int numberOfObjects = 0;
7
8     /** Construct a circle with radius 1 */
9     public CircleWithPrivateDataFields() {
10        numberOfObjects++;
11    }
12
13    /** Construct a circle with a specified radius */
14    public CircleWithPrivateDataFields(double newRadius) {
15        radius = newRadius;

```

```

16     numberOfObjects++;
17 }
18
19 /** Return radius */
20 public double getRadius() {           accessor method
21     return radius;
22 }
23
24 /** Set a new radius */
25 public void setRadius(double newRadius) { mutator method
26     radius = (newRadius >= 0) ? newRadius : 0;
27 }
28
29 /** Return numberOfObjects */
30 public static int getNumberOfObjects() { accessor method
31     return numberOfObjects;
32 }
33
34 /** Return the area of this circle */
35 public double getArea() {
36     return radius * radius * Math.PI;
37 }
38 }

```

The `getRadius()` method (lines 20–22) returns the radius, and the `setRadius(newRadius)` method (line 25–27) sets a new radius for the object. If the new radius is negative, `0` is set as the radius for the object. Since these methods are the only ways to read and modify the radius, you have total control over how the `radius` property is accessed. If you have to change the implementation of these methods, you don't need to change the client programs. This makes the class easy to maintain.

Listing 8.10 gives a client program that uses the `Circle` class to create a `Circle` object and modifies the radius using the `setRadius` method.

LISTING 8.10 TestCircleWithPrivateDataFields.java

```

1 public class TestCircleWithPrivateDataFields {
2     /** Main method */
3     public static void main(String[] args) {
4         // Create a circle with radius 5.0
5         CircleWithPrivateDataFields myCircle =
6             new CircleWithPrivateDataFields(5.0);
7         System.out.println("The area of the circle of radius "
8             + myCircle.getRadius() + " is " + myCircle.getArea());
9
10        // Increase myCircle's radius by 10%
11        myCircle.setRadius(myCircle.getRadius() * 1.1);
12        System.out.println("The area of the circle of radius "
13            + myCircle.getRadius() + " is " + myCircle.getArea());
14
15        System.out.println("The number of objects created is "
16            + CircleWithPrivateDataFields.getNumberOfObjects());
17    }
18 }

```

The data field `radius` is declared private. Private data can be accessed only within their defining class, so you cannot use `myCircle.radius` in the client program. A compile error would occur if you attempted to access private data from a client.

Since `numberOfObjects` is private, it cannot be modified. This prevents tampering. For example, the user cannot set `numberOfObjects` to `100`. The only way to make it `100` is to create `100` objects of the `Circle` class.

Suppose you combined `TestCircleWithPrivateDataFields` and `Circle` into one class by moving the `main` method in `TestCircleWithPrivateDataFields` into `Circle`. Could you use `myCircle.radius` in the `main` method? See Checkpoint Question 8.22 for the answer.



Design Guide

To prevent data from being tampered with and to make the class easy to maintain, declare data fields private.



MyProgrammingLab™

8.20 What is an accessor method? What is a mutator method? What are the naming conventions for accessor methods and mutator methods?

8.21 What are the benefits of data field encapsulation?

8.22 In the following code, `radius` is private in the `Circle` class, and `myCircle` is an object of the `Circle` class. Does the highlighted code cause any problems? If so, explain why.

```
public class Circle {
    private double radius = 1;

    /** Find the area of this circle */
    public double getArea() {
        return radius * radius * Math.PI;
    }

    public static void main(String[] args) {
        Circle myCircle = new Circle();
        System.out.println("Radius is " + myCircle.radius);
    }
}
```

8.10 Passing Objects to Methods



Passing an object to a method is to pass the reference of the object.

You can pass objects to methods. Like passing an array, passing an object is actually passing the reference of the object. The following code passes the `myCircle` object as an argument to the `printCircle` method:

```
1 public class Test {
2     public static void main(String[] args) {
3         // CircleWithPrivateDataFields is defined in Listing 8.9
4         CircleWithPrivateDataFields myCircle = new
5             CircleWithPrivateDataFields(5.0);
6         printCircle(myCircle);
7     }
8
9     public static void printCircle(CircleWithPrivateDataFields c) {
10        System.out.println("The area of the circle of radius "
11            + c.getRadius() + " is " + c.getArea());
12    }
13 }
```

pass an object

pass-by-value

Java uses exactly one mode of passing arguments: pass-by-value. In the preceding code, the value of `myCircle` is passed to the `printCircle` method. This value is a reference to a `Circle` object.

The program in Listing 8.11 demonstrates the difference between passing a primitive type value and passing a reference value.

LISTING 8.11 TestPassObject.java

```

1 public class TestPassObject {
2     /** Main method */
3     public static void main(String[] args) {
4         // Create a Circle object with radius 1
5         CircleWithPrivateDataFields myCircle =
6             new CircleWithPrivateDataFields(1);
7
8         // Print areas for radius 1, 2, 3, 4, and 5.
9         int n = 5;
10        printAreas(myCircle, n);
11
12        // See myCircle.radius and times
13        System.out.println("\n" + "Radius is " + myCircle.getRadius());
14        System.out.println("n is " + n);
15    }
16
17    /** Print a table of areas for radius */
18    public static void printAreas(
19        CircleWithPrivateDataFields c, int times) {
20        System.out.println("Radius \t\tArea");
21        while (times >= 1) {
22            System.out.println(c.getRadius() + "\t\t" + c.getArea());
23            c.setRadius(c.getRadius() + 1);
24            times--;
25        }
26    }
27 }

```

pass object

object parameter



```

Radius      Area
1.0         3.141592653589793
2.0         12.566370614359172
3.0         29.274333882308138
4.0         50.26548245743669
5.0         79.53981633974483
Radius is 6.0
n is 5

```

The `CircleWithPrivateDataFields` class is defined in Listing 8.9. The program passes a `CircleWithPrivateDataFields` object `myCircle` and an integer value from `n` to invoke `printAreas(myCircle, n)` (line 9), which prints a table of areas for radii 1, 2, 3, 4, 5, as shown in the sample output.

Figure 8.18 shows the call stack for executing the methods in the program. Note that the objects are stored in a heap (see Section 6.6).

When passing an argument of a primitive data type, the value of the argument is passed. In this case, the value of `n` (5) is passed to `times`. Inside the `printAreas` method, the content of `times` is changed; this does not affect the content of `n`.

When passing an argument of a reference type, the reference of the object is passed. In this case, `c` contains a reference for the object that is also referenced via `myCircle`. Therefore, changing the properties of the object through `c` inside the `printAreas` method has the same effect as doing so outside the method through the variable `myCircle`. Pass-by-value on references can be best described semantically as *pass-by-sharing*; that is, the object referenced in the method is the same as the object being passed.

pass-by-sharing

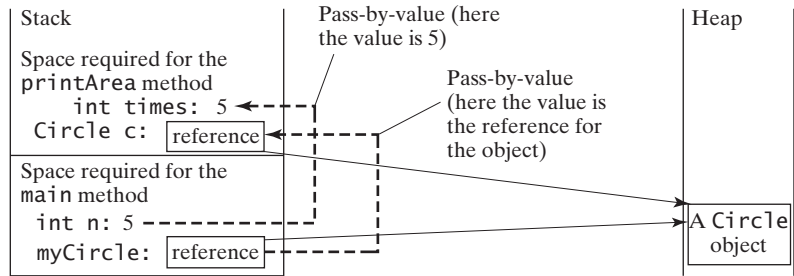


FIGURE 8.18 The value of `n` is passed to `times`, and the reference to `myCircle` is passed to `c` in the `printAreas` method.



8.23 Describe the difference between passing a parameter of a primitive type and passing a parameter of a reference type. Show the output of the following programs:

MyProgrammingLab™

```
public class Test {
    public static void main(String[] args) {
        Count myCount = new Count();
        int times = 0;

        for (int i = 0; i < 100; i++)
            increment(myCount, times);

        System.out.println("count is " + myCount.count);
        System.out.println("times is " + times);
    }

    public static void increment(Count c, int times) {
        c.count++;
        times++;
    }
}
```

```
public class Count {
    public int count;

    public Count(int c) {
        count = c;
    }

    public Count() {
        count = 1;
    }
}
```

8.24 Show the output of the following program:

```
public class Test {
    public static void main(String[] args) {
        Circle circle1 = new Circle(1);
        Circle circle2 = new Circle(2);

        swap1(circle1, circle2);
        System.out.println("After swap1: circle1 = " +
            circle1.radius + " circle2 = " + circle2.radius);

        swap2(circle1, circle2);
        System.out.println("After swap2: circle1 = " +
            circle1.radius + " circle2 = " + circle2.radius);
    }

    public static void swap1(Circle x, Circle y) {
        Circle temp = x;
        x = y;
        y = temp;
    }
}
```



```

    }

    public static void swap2(Circle x, Circle y) {
        double temp = x.radius;
        x.radius = y.radius;
        y.radius = temp;
    }
}

class Circle {
    double radius;

    Circle(double newRadius) {
        radius = newRadius;
    }
}

```

8.25 Show the printout of the following code:

```

public class Test {
    public static void main(String[] args) {
        int[] a = {1, 2};
        swap(a[0], a[1]);
        System.out.println("a[0] = " + a[0]
            + " a[1] = " + a[1]);
    }

    public static void swap(int n1, int n2) {
        int temp = n1;
        n1 = n2;
        n2 = temp;
    }
}

```

(a)

```

public class Test {
    public static void main(String[] args) {
        int[] a = {1, 2};
        swap(a);
        System.out.println("a[0] = " + a[0]
            + " a[1] = " + a[1]);
    }

    public static void swap(int[] a) {
        int temp = a[0];
        a[0] = a[1];
        a[1] = temp;
    }
}

```

(b)

```

public class Test {
    public static void main(String[] args) {
        T t = new T();
        swap(t);
        System.out.println("e1 = " + t.e1
            + " e2 = " + t.e2);
    }

    public static void swap(T t) {
        int temp = t.e1;
        t.e1 = t.e2;
        t.e2 = temp;
    }
}

class T {
    int e1 = 1;
    int e2 = 2;
}

```

(c)

```

public class Test {
    public static void main(String[] args) {
        T t1 = new T();
        T t2 = new T();
        System.out.println("t1's i = " +
            t1.i + " and j = " + t1.j);
        System.out.println("t2's i = " +
            t2.i + " and j = " + t2.j);
    }
}

class T {
    static int i = 0;
    int j = 0;

    T() {
        i++;
        j = 1;
    }
}

```

(d)

8.26 What is the output of the following programs?

```
import java.util.Date;

public class Test {
    public static void main(String[] args) {
        Date date = null;
        m1(date);
        System.out.println(date);
    }

    public static void m1(Date date) {
        date = new Date();
    }
}
```

(a)

```
import java.util.Date;

public class Test {
    public static void main(String[] args) {
        Date date = new Date(1234567);
        m1(date);
        System.out.println(date.getTime());
    }

    public static void m1(Date date) {
        date = new Date(7654321);
    }
}
```

(b)

```
import java.util.Date;

public class Test {
    public static void main(String[] args) {
        Date date = new Date(1234567);
        m1(date);
        System.out.println(date.getTime());
    }

    public static void m1(Date date) {
        date.setTime(7654321);
    }
}
```

(c)

```
import java.util.Date;

public class Test {
    public static void main(String[] args) {
        Date date = new Date(1234567);
        m1(date);
        System.out.println(date.getTime());
    }

    public static void m1(Date date) {
        date = null;
    }
}
```

(d)

8.11 Array of Objects



An array can hold objects as well as primitive type values.

Chapter 6, Single-Dimensional Arrays, described how to create arrays of primitive type elements. You can also create arrays of objects. For example, the following statement declares and creates an array of ten **Circle** objects:

```
Circle[] circleArray = new Circle[10];
```

To initialize **circleArray**, you can use a **for** loop like this one:

```
for (int i = 0; i < circleArray.length; i++) {
    circleArray[i] = new Circle();
}
```

An array of objects is actually an *array of reference variables*. So, invoking **circleArray[1].getArea()** involves two levels of referencing, as shown in Figure 8.19. **circleArray** references the entire array; **circleArray[1]** references a **Circle** object.

**Note**

When an array of objects is created using the **new** operator, each element in the array is a reference variable with a default value of **null**.

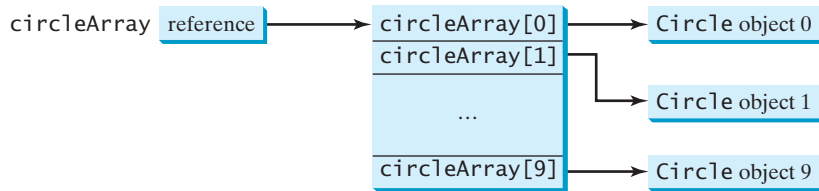


FIGURE 8.19 In an array of objects, an element of the array contains a reference to an object.

Listing 8.12 gives an example that demonstrates how to use an array of objects. The program summarizes the areas of an array of circles. The program creates `circleArray`, an array composed of five `Circle` objects; it then initializes circle radii with random values and displays the total area of the circles in the array.

LISTING 8.12 TotalArea.java

```

1  public class TotalArea {
2      /** Main method */
3      public static void main(String[] args) {
4          // Declare circleArray
5          CircleWithPrivateDataFields[] circleArray;
6
7          // Create circleArray
8          circleArray = createCircleArray();
9
10         // Print circleArray and total areas of the circles
11         printCircleArray(circleArray);
12     }
13
14     /** Create an array of Circle objects */
15     public static CircleWithPrivateDataFields[] createCircleArray() {
16         CircleWithPrivateDataFields[] circleArray =
17             new CircleWithPrivateDataFields[5];
18
19         for (int i = 0; i < circleArray.length; i++) {
20             circleArray[i] =
21                 new CircleWithPrivateDataFields(Math.random() * 100);
22         }
23
24         // Return Circle array
25         return circleArray;
26     }
27
28     /** Print an array of circles and their total area */
29     public static void printCircleArray(
30         CircleWithPrivateDataFields[] circleArray) {
31         System.out.printf("%-30s%-15s\n", "Radius", "Area");
32         for (int i = 0; i < circleArray.length; i++) {
33             System.out.printf("%-30f%-15f\n", circleArray[i].getRadius(),
34                 circleArray[i].getArea());
35         }
36
37         System.out.println("-----");
38
39         // Compute and display the result
40         System.out.printf("%-30s%-15f\n", "The total area of circles is",
41             sum(circleArray));

```

array of objects

return array of objects

pass array of objects

```

42     }
43
44     /** Add circle areas */
45     public static double sum(CircleWithDataFields[] circleArray) {
46         // Initialize sum
47         double sum = 0;
48
49         // Add areas to sum
50         for (int i = 0; i < circleArray.length; i++)
51             sum += circleArray[i].getArea();
52
53         return sum;
54     }
55 }

```

pass array of objects



Radius	Area
70.577708	15648.941866
44.152266	6124.291736
24.867853	1942.792644
5.680718	101.380949
36.734246	4239.280350

The total area of circles is 28056.687544	

The program invokes `createCircleArray()` (line 8) to create an array of five circle objects. Several circle classes were introduced in this chapter. This example uses the `CircleWithDataFields` class introduced in Section 8.9, Data Field Encapsulation.

The circle radii are randomly generated using the `Math.random()` method (line 21). The `createCircleArray` method returns an array of `CircleWithDataFields` objects (line 25). The array is passed to the `printCircleArray` method, which displays the radius and area of each circle and the total area of the circles.

The sum of the circle areas is computed by invoking the `sum` method (line 41), which takes the array of `CircleWithDataFields` objects as the argument and returns a `double` value for the total area.



MyProgrammingLab™

8.27 What is wrong in the following code?

```

1 public class Test {
2     public static void main(String[] args) {
3         java.util.Date[] dates = new java.util.Date[10];
4         System.out.println(dates[0]);
5         System.out.println(dates[0].toString());
6     }
7 }

```

KEY TERMS

action	296	constructor	296
anonymous object	305	data field	296
attribute	296	data field encapsulation	319
behavior	296	default constructor	303
class	296	dot operator (.)	304
client	299	getter (or accessor)	320

instance	296	property	296
instance method	305	public class	299
instance variable	305	reference type	304
instantiation	296	reference variable	304
no-arg constructor	303	setter (or mutator)	320
null value	305	state	296
object	296	static method	312
object-oriented programming (OOP)		static variable	312
package-private (or package-access)	317	Unified Modeling Language (UML)	297
private constructor	319		

CHAPTER SUMMARY

1. A *class* is a template for *objects*. It defines the *properties* of objects and provides *constructors* for creating objects and methods for manipulating them.
2. A class is also a data type. You can use it to declare object *reference variables*. An object reference variable that appears to hold an object actually contains a reference to that object. Strictly speaking, an object reference variable and an object are different, but most of the time the distinction can be ignored.
3. An object is an *instance* of a class. You use the **new** operator to create an object, and the *dot operator* (`.`) to access members of that object through its reference variable.
4. An *instance variable* or *method* belongs to an instance of a class. Its use is associated with individual instances. A *static variable* is a variable shared by all instances of the same class. A *static method* is a method that can be invoked without using instances.
5. Every instance of a class can access the class's static variables and methods. For clarity, however, it is better to invoke static variables and methods using **ClassName.variable** and **ClassName.method**.
6. Modifiers specify how the class, method, and data are accessed. A **public** class, method, or data is accessible to all clients. A **private** method or data is accessible only inside the class.
7. You can provide a **get** method or a **set** method to enable clients to see or modify the data. Colloquially, a **get** method is referred to as a *getter* (or *accessor*), and a **set** method as a *setter* (or *mutator*).
8. A **get** method has the signature **public returnType getPropertyname()**. If the **returnType** is **boolean**, the **get** method should be defined as **public boolean isPropertyname()**. A **set** method has the signature **public void setPropertyname(dataType propertyValue)**.
9. All parameters are passed to methods using pass-by-value. For a parameter of a primitive type, the actual value is passed; for a parameter of a *reference type*, the reference for the object is passed.
10. A Java array is an object that can contain primitive type values or object type values. When an array of objects is created, its elements are assigned the default value of **null**.

TEST QUESTIONS

Do the test questions for this chapter online at www.cs.armstrong.edu/liang/intro9e/test.html.

MyProgrammingLab™

PROGRAMMING EXERCISES

three objectives



Pedagogical Note

The exercises in Chapters 8–11, 15 help you achieve three objectives:

- Design classes and draw UML class diagrams
- Implement classes from the UML
- Use classes to develop applications

Students can download solutions for the UML diagrams for the even-numbered exercises from the Companion Website, and instructors can download all solutions from the same site.

Sections 8.2–8.5

8.1 (The *Rectangle* class) Following the example of the *Circle* class in Section 8.2, design a class named *Rectangle* to represent a rectangle. The class contains:

- Two **double** data fields named **width** and **height** that specify the width and height of the rectangle. The default values are **1** for both **width** and **height**.
- A no-arg constructor that creates a default rectangle.
- A constructor that creates a rectangle with the specified **width** and **height**.
- A method named **getArea()** that returns the area of this rectangle.
- A method named **getPerimeter()** that returns the perimeter.

Draw the UML diagram for the class and then implement the class. Write a test program that creates two *Rectangle* objects—one with width **4** and height **40** and the other with width **3.5** and height **35.9**. Display the width, height, area, and perimeter of each rectangle in this order.

8.2 (The *Stock* class) Following the example of the *Circle* class in Section 8.2, design a class named *Stock* that contains:

- A string data field named **symbol** for the stock's symbol.
- A string data field named **name** for the stock's name.
- A **double** data field named **previousClosingPrice** that stores the stock price for the previous day.
- A **double** data field named **currentPrice** that stores the stock price for the current time.
- A constructor that creates a stock with the specified symbol and name.
- A method named **getChangePercent()** that returns the percentage changed from **previousClosingPrice** to **currentPrice**.

Draw the UML diagram for the class and then implement the class. Write a test program that creates a *Stock* object with the stock symbol **ORCL**, the name **Oracle Corporation**, and the previous closing price of **34.5**. Set a new current price to **34.35** and display the price-change percentage.

Section 8.6

***8.3** (Use the *Date* class) Write a program that creates a *Date* object, sets its elapsed time to **10000**, **100000**, **1000000**, **10000000**, **100000000**, **1000000000**, **10000000000**, and **100000000000**, and displays the date and time using the **toString()** method, respectively.

- *8.4** (Use the *Random* class) Write a program that creates a *Random* object with seed **1000** and displays the first 50 random integers between **0** and **100** using the *nextInt(100)* method.
- *8.5** (Use the *GregorianCalendar* class) Java API has the *GregorianCalendar* class in the *java.util* package, which you can use to obtain the year, month, and day of a date. The no-arg constructor constructs an instance for the current date, and the methods *get(GregorianCalendar.YEAR)*, *get(GregorianCalendar.MONTH)*, and *get(GregorianCalendar.DAY_OF_MONTH)* return the year, month, and day. Write a program to perform two tasks:
- Display the current year, month, and day.
 - The *GregorianCalendar* class has the *setTimeInMillis(long)*, which can be used to set a specified elapsed time since January 1, 1970. Set the value to **1234567898765L** and display the year, month, and day.

Sections 8.7–8.9

- **8.6** (*Display calendars*) Rewrite the *PrintCalendar* class in Listing 5.12 to display calendars in a message dialog box. Since the output is generated from several static methods in the class, you may define a static *String* variable **output** for storing the output and display it in a message dialog box.

- 8.7** (*The Account class*) Design a class named *Account* that contains:

- A private *int* data field named **id** for the account (default **0**).
- A private *double* data field named **balance** for the account (default **0**).
- A private *double* data field named **annualInterestRate** that stores the current interest rate (default **0**). Assume all accounts have the same interest rate.
- A private *Date* data field named **dateCreated** that stores the date when the account was created.
- A no-arg constructor that creates a default account.
- A constructor that creates an account with the specified **id** and initial balance.
- The accessor and mutator methods for **id**, **balance**, and **annualInterestRate**.
- The accessor method for **dateCreated**.
- A method named *getMonthlyInterestRate()* that returns the monthly interest rate.
- A method named *getMonthlyInterest()* that returns the monthly interest.
- A method named **withdraw** that withdraws a specified amount from the account.
- A method named **deposit** that deposits a specified amount to the account.

Draw the UML diagram for the class and then implement the class. (*Hint*: The method *getMonthlyInterest()* is to return monthly interest, not the interest rate. Monthly interest is $\text{balance} * \text{monthlyInterestRate}$. $\text{monthlyInterestRate}$ is $\text{annualInterestRate} / 12$. Note that **annualInterestRate** is a percentage, e.g., like 4.5%. You need to divide it by 100.)

Write a test program that creates an *Account* object with an account ID of 1122, a balance of \$20,000, and an annual interest rate of 4.5%. Use the **withdraw** method to withdraw \$2,500, use the **deposit** method to deposit \$3,000, and print the balance, the monthly interest, and the date when this account was created.

- 8.8** (*The Fan class*) Design a class named *Fan* to represent a fan. The class contains:

- Three constants named **SLOW**, **MEDIUM**, and **FAST** with the values **1**, **2**, and **3** to denote the fan speed.



- A private **int** data field named **speed** that specifies the speed of the fan (the default is **SLOW**).
- A private **boolean** data field named **on** that specifies whether the fan is on (the default is **false**).
- A private **double** data field named **radius** that specifies the radius of the fan (the default is **5**).
- A string data field named **color** that specifies the color of the fan (the default is **blue**).
- The accessor and mutator methods for all four data fields.
- A no-arg constructor that creates a default fan.
- A method named **toString()** that returns a string description for the fan. If the fan is on, the method returns the fan speed, color, and radius in one combined string. If the fan is not on, the method returns the fan color and radius along with the string “fan is off” in one combined string.

Draw the UML diagram for the class and then implement the class. Write a test program that creates two **Fan** objects. Assign maximum speed, radius **10**, color **yellow**, and turn it on to the first object. Assign medium speed, radius **5**, color **blue**, and turn it off to the second object. Display the objects by invoking their **toString** method.

****8.9** (*Geometry: n-sided regular polygon*) In an n -sided regular polygon, all sides have the same length and all angles have the same degree (i.e., the polygon is both equilateral and equiangular). Design a class named **RegularPolygon** that contains:

- A private **int** data field named **n** that defines the number of sides in the polygon with default value **3**.
- A private **double** data field named **side** that stores the length of the side with default value **1**.
- A private **double** data field named **x** that defines the x -coordinate of the polygon’s center with default value **0**.
- A private **double** data field named **y** that defines the y -coordinate of the polygon’s center with default value **0**.
- A no-arg constructor that creates a regular polygon with default values.
- A constructor that creates a regular polygon with the specified number of sides and length of side, centered at **(0, 0)**.
- A constructor that creates a regular polygon with the specified number of sides, length of side, and x - and y -coordinates.
- The accessor and mutator methods for all data fields.
- The method **getPerimeter()** that returns the perimeter of the polygon.

■ The method **getArea()** that returns the area of the polygon. The formula for computing the area of a regular polygon is $Area = \frac{n \times s^2}{4 \times \tan\left(\frac{\pi}{n}\right)}$.

Draw the UML diagram for the class and then implement the class. Write a test program that creates three **RegularPolygon** objects, created using the no-arg constructor, using **RegularPolygon(6, 4)**, and using **RegularPolygon(10, 4, 5.6, 7.8)**. For each object, display its perimeter and area.

***8.10** (*Algebra: quadratic equations*) Design a class named **QuadraticEquation** for a quadratic equation $ax^2 + bx + c = 0$. The class contains:

- Private data fields **a**, **b**, and **c** that represent three coefficients.
- A constructor for the arguments for **a**, **b**, and **c**.

- Three `get` methods for `a`, `b`, and `c`.
- A method named `getDiscriminant()` that returns the discriminant, which is $b^2 - 4ac$.
- The methods named `getRoot1()` and `getRoot2()` for returning two roots of the equation

$$r_1 = \frac{-b + \sqrt{b^2 - 4ac}}{2a} \quad \text{and} \quad r_2 = \frac{-b - \sqrt{b^2 - 4ac}}{2a}$$

These methods are useful only if the discriminant is nonnegative. Let these methods return `0` if the discriminant is negative.

Draw the UML diagram for the class and then implement the class. Write a test program that prompts the user to enter values for `a`, `b`, and `c` and displays the result based on the discriminant. If the discriminant is positive, display the two roots. If the discriminant is 0, display the one root. Otherwise, display “The equation has no roots.” See Programming Exercise 3.1 for sample runs.

- *8.11** (*Algebra: 2×2 linear equations*) Design a class named `LinearEquation` for a 2×2 system of linear equations:

$$\begin{array}{l} ax + by = e \\ cx + dy = f \end{array} \quad x = \frac{ed - bf}{ad - bc} \quad y = \frac{af - ec}{ad - bc}$$

The class contains:

- Private data fields `a`, `b`, `c`, `d`, `e`, and `f`.
- A constructor with the arguments for `a`, `b`, `c`, `d`, `e`, and `f`.
- Six `get` methods for `a`, `b`, `c`, `d`, `e`, and `f`.
- A method named `isSolvable()` that returns true if $ad - bc$ is not 0.
- Methods `getX()` and `getY()` that return the solution for the equation.

Draw the UML diagram for the class and then implement the class. Write a test program that prompts the user to enter `a`, `b`, `c`, `d`, `e`, and `f` and displays the result. If $ad - bc$ is 0, report that “The equation has no solution.” See Programming Exercise 3.3 for sample runs.

- **8.12** (*Geometry: intersection*) Suppose two line segments intersect. The two endpoints for the first line segment are `(x1, y1)` and `(x2, y2)` and for the second line segment are `(x3, y3)` and `(x4, y4)`. Write a program that prompts the user to enter these four endpoints and displays the intersecting point. (*Hint*: Use the `LinearEquation` class in Exercise 8.11.)

```
Enter the endpoints of the first line segment: 2.0 2.0 0 0
Enter the endpoints of the second line segment: 0 2.0 2.0 0
The intersecting point is: (1.0, 1.0)
```



- **8.13** (*The Location class*) Design a class named `Location` for locating a maximal value and its location in a two-dimensional array. The class contains public data fields `row`, `column`, and `maxValue` that store the maximal value and its indices in a two-dimensional array with `row` and `column` as `int` types and `maxValue` as a `double` type.

Write the following method that returns the location of the largest element in a two-dimensional array:

```
public static Location locateLargest(double[][] a)
```

The return value is an instance of `Location`. Write a test program that prompts the user to enter a two-dimensional array and displays the location of the largest element in the array. Here is a sample run:



```
Enter the number of rows and columns in the array: 3 4 Enter
Enter the array:
23.5 35 2 10 Enter
4.5 3 45 3.5 Enter
35 44 5.5 9.6 Enter
The location of the largest element is 45 at (1, 2)
```

***8.14** (*Stopwatch*) Design a class named `StopWatch`. The class contains:

- Private data fields `startTime` and `endTime` with get methods.
- A no-arg constructor that initializes `startTime` with the current time.
- A method named `start()` that resets the `startTime` to the current time.
- A method named `stop()` that sets the `endTime` to the current time.
- A method named `getElapsedTime()` that returns the elapsed time for the stopwatch in milliseconds.

Draw the UML diagram for the class and then implement the class. Write a test program that measures the execution time of sorting 100,000 numbers using selection sort.

STRINGS

Objectives

- To use the **String** class to process fixed strings (§9.2).
- To construct strings (§9.2.1).
- To understand that strings are immutable and to create an interned string (§9.2.2).
- To compare strings (§9.2.3).
- To get string length and characters, and combine strings (§9.2.4).
- To obtain substrings (§9.2.5).
- To convert, replace, and split strings (§9.2.6).
- To match, replace, and split strings by patterns (§9.2.7).
- To search for a character or substring in a string (§9.2.8).
- To convert between a string and an array (§9.2.9).
- To convert characters and numbers into a string (§9.2.10).
- To obtain a formatted string (§9.2.11).
- To check whether a string is a palindrome (§9.3).
- To convert hexadecimal numbers to decimal numbers (§9.4).
- To use the **Character** class to process a single character (§9.5).
- To use the **StringBuilder** and **StringBuffer** classes to process flexible strings (§9.6).
- To distinguish among the **String**, **StringBuilder**, and **StringBuffer** classes (§9.2–9.6).
- To learn how to pass arguments to the **main** method from the command line (§9.7).



9.1 Introduction



The classes **String**, **StringBuilder**, and **StringBuffer** are used for processing strings.

A *string* is a sequence of characters. Strings are frequently used in programming. In many languages, strings are treated as an array of characters, but in Java a string is treated as an object. This chapter introduces the classes for processing strings.

9.2 The String Class



A **String** object is *immutable*: Its content cannot be changed once the string is created.

The **String** class has 13 constructors and more than 40 methods for manipulating strings. Not only is it very useful in programming, but it is also a good example for learning classes and objects.

9.2.1 Constructing a String

You can create a string object from a string literal or from an array of characters. To create a string from a string literal, use the syntax:

```
String newString = new String(stringLiteral);
```

The argument **stringLiteral** is a sequence of characters enclosed inside double quotes. The following statement creates a **String** object **message** for the string literal **"Welcome to Java"**:

```
String message = new String("Welcome to Java");
```

string literal object

Java treats a string literal as a **String** object. Thus, the following statement is valid:

```
String message = "Welcome to Java";
```

You can also create a string from an array of characters. For example, the following statements create the string **"Good Day"**:

```
char[] charArray = {'G', 'o', 'o', 'd', ' ', 'D', 'a', 'y'};
String message = new String(charArray);
```



Note

A **String** variable holds a reference to a **String** object that stores a string value. Strictly speaking, the terms **String variable**, **String object**, and *string value* are different, but most of the time the distinctions between them can be ignored. For simplicity, the term *string* will often be used to refer to **String** variable, **String** object, and string value.

String variable, String object, string value

9.2.2 Immutable Strings and Interned Strings

immutable

A **String** object is *immutable*; its contents cannot be changed. Does the following code change the contents of the string?

```
String s = "Java";
s = "HTML";
```

The answer is no. The first statement creates a **String** object with the content **"Java"** and assigns its reference to **s**. The second statement creates a new **String** object with the content

"HTML" and assigns its reference to **s**. The first **String** object still exists after the assignment, but it can no longer be accessed, because variable **s** now points to the new object, as shown in Figure 9.1.

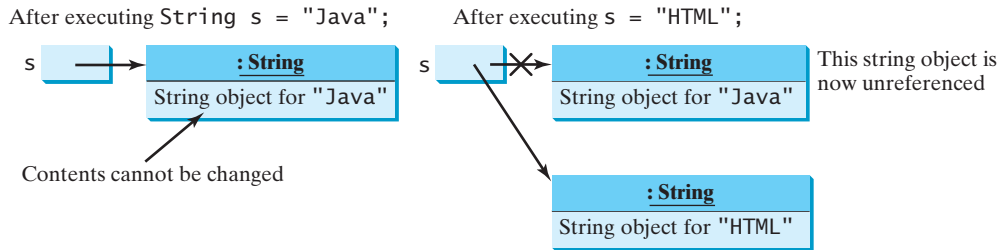
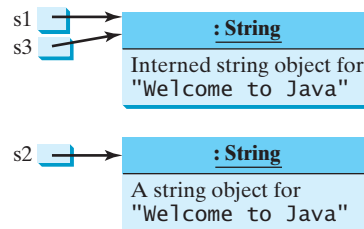


FIGURE 9.1 Strings are immutable; once created, their contents cannot be changed.

Because strings are immutable and are ubiquitous in programming, the JVM uses a unique instance for string literals with the same character sequence in order to improve efficiency and save memory. Such an instance is called an *interned string*. For example, the following statements:

```
String s1 = "Welcome to Java";
String s2 = new String("Welcome to Java");
String s3 = "Welcome to Java";

System.out.println("s1 == s2 is " + (s1 == s2));
System.out.println("s1 == s3 is " + (s1 == s3));
```



interned string

display

```
s1 == s2 is false
s1 == s3 is true
```

In the preceding statements, **s1** and **s3** refer to the same interned string—"Welcome to Java"—so **s1 == s3** is **true**. However, **s1 == s2** is **false**, because **s1** and **s2** are two different string objects, even though they have the same contents.

9.2.3 String Comparisons

The **String** class provides the methods for comparing strings, as shown in Figure 9.2.

How do you compare the contents of two strings? You might attempt to use the **==** operator, as follows:

```
if (string1 == string2)
    System.out.println("string1 and string2 are the same object");
else
    System.out.println("string1 and string2 are different objects");
```

However, the **==** operator checks only whether **string1** and **string2** refer to the same object; it does not tell you whether they have the same contents. Therefore, you cannot use the **==** operator to find out whether two string variables have the same contents. Instead, you should use the **equals** method. The following code, for instance, can be used to compare two strings:

```
if (string1.equals(string2))
    System.out.println("string1 and string2 have the same contents");
else
    System.out.println("string1 and string2 are not equal");
```

string1.equals(string2)

java.lang.String	
+equals(s1: Object): boolean	Returns true if this string is equal to string s1.
+equalsIgnoreCase(s1: String): boolean	Returns true if this string is equal to string s1 case insensitive.
+compareTo(s1: String): int	Returns an integer greater than 0, equal to 0, or less than 0 to indicate whether this string is greater than, equal to, or less than s1.
+compareToIgnoreCase(s1: String): int	Same as compareTo except that the comparison is case insensitive.
+regionMatches(index: int, s1: String, s1Index: int, len: int): boolean	Returns true if the specified subregion of this string exactly matches the specified subregion in string s1.
+regionMatches(ignoreCase: boolean, index: int, s1: String, s1Index: int, len: int): boolean	Same as the preceding method except that you can specify whether the match is case sensitive.
+startsWith(prefix: String): boolean	Returns true if this string starts with the specified prefix.
+endsWith(suffix: String): boolean	Returns true if this string ends with the specified suffix.

FIGURE 9.2 The `String` class contains the methods for comparing strings.

Note that parameter type for the `equals` method is `Object`. We will introduce the `Object` class in Chapter 11. For now, you can replace `Object` by `String` for using the `equals` method to compare two strings. For example, the following statements display `true` and then `false`.

```
String s1 = new String("Welcome to Java");
String s2 = "Welcome to Java";
String s3 = "Welcome to C++";
System.out.println(s1.equals(s2)); // true
System.out.println(s1.equals(s3)); // false
```

The `compareTo` method can also be used to compare two strings. For example, consider the following code:

```
s1.compareTo(s2)           s1.compareTo(s2)
```

The method returns the value `0` if `s1` is equal to `s2`, a value less than `0` if `s1` is lexicographically (i.e., in terms of Unicode ordering) less than `s2`, and a value greater than `0` if `s1` is lexicographically greater than `s2`.

The actual value returned from the `compareTo` method depends on the offset of the first two distinct characters in `s1` and `s2` from left to right. For example, suppose `s1` is `abc` and `s2` is `abg`, and `s1.compareTo(s2)` returns `-4`. The first two characters (`a` vs. `a`) from `s1` and `s2` are compared. Because they are equal, the second two characters (`b` vs. `b`) are compared. Because they are also equal, the third two characters (`c` vs. `g`) are compared. Since the character `c` is 4 less than `g`, the comparison returns `-4`.



Caution

Syntax errors will occur if you compare strings by using comparison operators `>`, `>=`, `<`, or `<=`. Instead, you have to use `s1.compareTo(s2)`.



Note

The `equals` method returns `true` if two strings are equal and `false` if they are not. The `compareTo` method returns `0`, a positive integer, or a negative integer, depending on whether one string is equal to, greater than, or less than the other string.

The `String` class also provides the `equalsIgnoreCase`, `compareToIgnoreCase`, and `regionMatches` methods for comparing strings. The `equalsIgnoreCase` and

compareToIgnoreCase methods ignore the case of the letters when comparing two strings. The **regionMatches** method compares portions of two strings for equality. You can also use **str.startsWith(prefix)** to check whether string **str** starts with a specified prefix, and **str.endsWith(suffix)** to check whether string **str** ends with a specified suffix.

9.2.4 Getting String Length and Characters, and Combining Strings

The **String** class provides the methods for obtaining a string's length, retrieving individual characters, and concatenating strings, as shown in Figure 9.3.

java.lang.String	
+length(): int	Returns the number of characters in this string.
+charAt(index: int): char	Returns the character at the specified index from this string.
+concat(s1: String): String	Returns a new string that concatenates this string with string s1.

FIGURE 9.3 The **String** class contains the methods for getting string length, individual characters, and combining strings.

You can get the length of a string by invoking its **length()** method. For example, **length()** **message.length()** returns the length of the string **message**.



Caution

length is a method in the **String** class but is a property of an array object. Therefore, you have to use **s.length()** to get the number of characters in string **s**, and **a.length** to get the number of elements in array **a**.

string length vs. array length

The **s.charAt(index)** method can be used to retrieve a specific character in a string **s**, where the index is between **0** and **s.length()-1**. For example, **message.charAt(0)** returns the character **W**, as shown in Figure 9.4.

charAt(index)



Note

When you use a string, you often know its literal value. For convenience, Java allows you to use the string literal to refer directly to strings without creating new variables. Thus, **"Welcome to Java".charAt(0)** is correct and returns **W**.

string literal

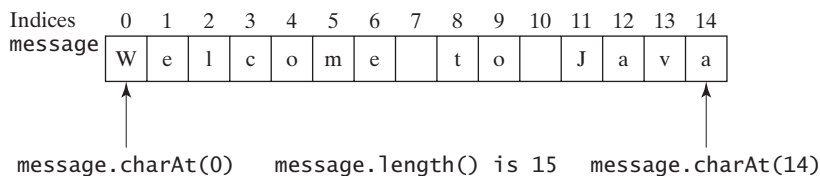


FIGURE 9.4 The characters in a **String** object are stored using an array internally.



Note

The **String** class uses an array to store characters internally. The array is private and cannot be accessed outside of the **String** class. The **String** class provides many public methods, such as **length()** and **charAt(index)**, to retrieve the string information. This is a good example of encapsulation: the data field of the class is hidden from the user through the private modifier, and thus the user cannot directly manipulate it. If the array were not private, the user would be able to change the string content by modifying the array. This would violate the tenet that the **String** class is immutable.

encapsulating string

string index range

**Caution**

Attempting to access characters in a string `s` out of bounds is a common programming error. To avoid it, make sure that you do not use an index beyond `s.length() - 1`. For example, `s.charAt(s.length())` would cause a `StringIndexOutOfBoundsException`.

You can use the `concat` method to concatenate two strings. The statement shown below, for example, concatenates strings `s1` and `s2` into `s3`:

```
s1.concat(s2)           String s3 = s1.concat(s2);
```

Because string concatenation is heavily used in programming, Java provides a convenient way to accomplish it. You can use the plus (+) operator to concatenate two strings, so the previous statement is equivalent to

```
s1 + s2                String s3 = s1 + s2;
```

The following code combines the strings `message`, " and ", and "HTML" into one string:

```
String myString = message + " and " + "HTML";
```

Recall that the + operator can also concatenate a number with a string. In this case, the number is converted into a string and then concatenated. Note that at least one of the operands must be a string in order for concatenation to take place.

9.2.5 Obtaining Substrings

You can obtain a single character from a string using the `charAt` method, as shown in Figure 9.3. You can also obtain a substring from a string using the `substring` method in the `String` class, as shown in Figure 9.5.

For example,

```
String message = "Welcome to Java".substring(0, 11) + "HTML";
```

The string `message` now becomes `Welcome to HTML`.

java.lang.String	
+substring(beginIndex: int): String	Returns this string's substring that begins with the character at the specified <code>beginIndex</code> and extends to the end of the string, as shown in Figure 9.6.
+substring(beginIndex: int, endIndex: int): String	Returns this string's substring that begins at the specified <code>beginIndex</code> and extends to the character at index <code>endIndex - 1</code> , as shown in Figure 9.6. Note that the character at <code>endIndex</code> is not part of the substring.

FIGURE 9.5 The `String` class contains the methods for obtaining substrings.

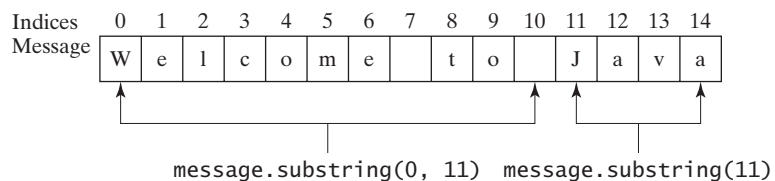


FIGURE 9.6 The `substring` method obtains a substring from a string.

**Note**

If **beginIndex** is **endIndex**, **substring(beginIndex, endIndex)** returns an empty string with length **0**. If **beginIndex** > **endIndex**, it would be a runtime error.

beginIndex <= **endIndex**

9.2.6 Converting, Replacing, and Splitting Strings

The **String** class provides the methods for converting, replacing, and splitting strings, as shown in Figure 9.7.

java.lang.String	
+toLowerCase(): String	Returns a new string with all characters converted to lowercase.
+toUpperCase(): String	Returns a new string with all characters converted to uppercase.
+trim(): String	Returns a new string with whitespace characters trimmed on both sides.
+replace(oldChar: char, newChar: char): String	Returns a new string that replaces all matching characters in this string with the new character.
+replaceFirst(oldString: String, newString: String): String	Returns a new string that replaces the first matching substring in this string with the new substring.
+replaceAll(oldString: String, newString: String): String	Returns a new string that replaces all matching substrings in this string with the new substring.
+split(delimiter: String): String[]	Returns an array of strings consisting of the substrings split by the delimiter.

FIGURE 9.7 The **String** class contains the methods for converting, replacing, and splitting strings.

Once a string is created, its contents cannot be changed. The methods **toLowerCase**, **toUpperCase**, **trim**, **replace**, **replaceFirst**, and **replaceAll** return a new string derived from the original string (without changing the original string!). The **toLowerCase** and **toUpperCase** methods return a new string by converting all the characters in the string to lowercase or uppercase. The **trim** method returns a new string by eliminating whitespace characters from both ends of the string. Several versions of the **replace** methods are provided to replace a character or a substring in the string with a new character or a new substring.

For example,

"Welcome". toLowerCase()	returns a new string, welcome.	toLowerCase()
"Welcome". toUpperCase()	returns a new string, WELCOME.	toUpperCase()
"\t Good Night \n". trim()	returns a new string, Good Night.	trim()
"Welcome". replace('e', 'A')	returns a new string, WA1comA.	replace
"Welcome". replaceFirst("e", "AB")	returns a new string, WAB1come.	replaceFirst
"Welcome". replace("e", "AB")	returns a new string, WAB1comAB.	replace
"Welcome". replace("e1", "AB")	returns a new string, WABcome.	replace

The **split** method can be used to extract tokens from a string with the specified delimiters. For example, the following code

```
String[] tokens = "Java#HTML#Perl".split("#");
for (int i = 0; i < tokens.length; i++)
    System.out.print(tokens[i] + " ");
```

displays

Java HTML Perl

9.2.7 Matching, Replacing and Splitting by Patterns

Often you will need to write code that validates user input, such as to check whether the input is a number, a string with all lowercase letters, or a Social Security number. How do you write this type of code? A simple and effective way to accomplish this task is to use the regular expression.

A *regular expression* (abbreviated *regex*) is a string that describes a pattern for matching a set of strings. You can match, replace, or split a string by specifying a pattern. This is an extremely useful and powerful feature.

Let us begin with the `matches` method in the `String` class. At first glance, the `matches` method is very similar to the `equals` method. For example, the following two statements both evaluate to `true`.

```
"Java".matches("Java");
"Java".equals("Java");
```

However, the `matches` method is more powerful. It can match not only a fixed string, but also a set of strings that follow a pattern. For example, the following statements all evaluate to `true`:

```
"Java is fun".matches("Java.*")
"Java is cool".matches("Java.*")
"Java is powerful".matches("Java.*")
```

`Java.*` in the preceding statements is a regular expression. It describes a string pattern that begins with Java followed by *any* zero or more characters. Here, the substring `.*` matches any zero or more characters.

The following statement evaluates to `true`.

```
"440-02-4534".matches("\\d{3}-\\d{2}-\\d{4}")
```

Here `\\d` represents a single digit, and `\\d{3}` represents three digits.

The `replaceAll`, `replaceFirst`, and `split` methods can be used with a regular expression. For example, the following statement returns a new string that replaces `$`, `+`, or `#` in `a+b$#c` with the string `NNN`.

```
replaceAll(regex)      String s = "a+b$#c".replaceAll("[$+#]", "NNN");
                        System.out.println(s);
```

Here the regular expression `[$+#]` specifies a pattern that matches `$`, `+`, or `#`. So, the output is `aNNNbNNNNNNc`.

The following statement splits the string into an array of strings delimited by punctuation marks.

```
split(regex)          String[] tokens = "Java,C?C#,C++".split("[.,:;?]*");

                        for (int i = 0; i < tokens.length; i++)
                            System.out.println(tokens[i]);
```

In this example, the regular expression `[.,:;?]*` specifies a pattern that matches `.`, `,`, `:`, `;`, or `?`. Each of these characters is a delimiter for splitting the string. Thus, the string is split into `Java`, `C`, `C#`, and `C++`, which are stored in array `tokens`.

further studies

Regular expression patterns are complex for beginning students to understand. For this reason, simple patterns are introduced in this section. Please refer to Supplement III.H, Regular Expressions, to learn more about these patterns.

9.2.8 Finding a Character or a Substring in a String

The `String` class provides several overloaded `indexOf` and `lastIndexOf` methods to find a character or a substring in a string, as shown in Figure 9.8.

java.lang.String	
+indexOf(ch: char): int	Returns the index of the first occurrence of ch in the string. Returns -1 if not matched.
+indexOf(ch: char, fromIndex: int): int	Returns the index of the first occurrence of ch after fromIndex in the string. Returns -1 if not matched.
+indexOf(s: String): int	Returns the index of the first occurrence of string s in this string. Returns -1 if not matched.
+indexOf(s: String, fromIndex: int): int	Returns the index of the first occurrence of string s in this string after fromIndex. Returns -1 if not matched.
+lastIndexOf(ch: int): int	Returns the index of the last occurrence of ch in the string. Returns -1 if not matched.
+lastIndexOf(ch: int, fromIndex: int): int	Returns the index of the last occurrence of ch before fromIndex in this string. Returns -1 if not matched.
+lastIndexOf(s: String): int	Returns the index of the last occurrence of string s. Returns -1 if not matched.
+lastIndexOf(s: String, fromIndex: int): int	Returns the index of the last occurrence of string s before fromIndex. Returns -1 if not matched.

FIGURE 9.8 The **String** class contains the methods for matching substrings.

For example,

```
"Welcome to Java".indexOf('W') returns 0.           indexOf
"Welcome to Java".indexOf('o') returns 4.
"Welcome to Java".indexOf('o', 5) returns 9.
"Welcome to Java".indexOf("come") returns 3.
"Welcome to Java".indexOf("Java", 5) returns 11.
"Welcome to Java".indexOf("java", 5) returns -1.

"Welcome to Java".lastIndexOf('W') returns 0.       lastIndexOf
"Welcome to Java".lastIndexOf('o') returns 9.
"Welcome to Java".lastIndexOf('o', 5) returns 4.
"Welcome to Java".lastIndexOf("come") returns 3.
"Welcome to Java".lastIndexOf("Java", 5) returns -1.
"Welcome to Java".lastIndexOf("Java") returns 11.
```

9.2.9 Conversion between Strings and Arrays

Strings are not arrays, but a string can be converted into an array, and vice versa. To convert a string into an array of characters, use the **toCharArray** method. For example, the following statement converts the string **Java** to an array. toCharArray

```
char[] chars = "Java".toCharArray();
```

Thus, **chars[0]** is **J**, **chars[1]** is **a**, **chars[2]** is **v**, and **chars[3]** is **a**.

You can also use the **getChars(int srcBegin, int srcEnd, char[] dst, int dstBegin)** method to copy a substring of the string from index **srcBegin** to index **srcEnd-1** into a character array **dst** starting from index **dstBegin**. For example, the following code copies a substring "3720" in "CS3720" from index 2 to index 6-1 into the character array **dst** starting from index 4. getChars

```
char[] dst = {'J', 'A', 'V', 'A', '1', '3', '0', '1'};
"CS3720".getChars(2, 6, dst, 4);
```

Thus, **dst** becomes **{'J', 'A', 'V', 'A', '3', '7', '2', '0'}**.

To convert an array of characters into a string, use the `String(char[])` constructor or the `valueOf(char[])` method. For example, the following statement constructs a string from an array using the `String` constructor.

```
String str = new String(new char[]{'J', 'a', 'v', 'a'});
```

valueOf

The next statement constructs a string from an array using the `valueOf` method.

```
String str = String.valueOf(new char[]{'J', 'a', 'v', 'a'});
```

9.2.10 Converting Characters and Numeric Values to Strings

overloaded valueOf

The static `valueOf` method can be used to convert an array of characters into a string. There are several overloaded versions of the `valueOf` method that can be used to convert a character and numeric values to strings with different parameter types, `char`, `double`, `long`, `int`, and `float`, as shown in Figure 9.9.

java.lang.String	
<code>+valueOf(c: char): String</code>	Returns a string consisting of the character <code>c</code> .
<code>+valueOf(data: char[]): String</code>	Returns a string consisting of the characters in the array.
<code>+valueOf(d: double): String</code>	Returns a string representing the <code>double</code> value.
<code>+valueOf(f: float): String</code>	Returns a string representing the <code>float</code> value.
<code>+valueOf(i: int): String</code>	Returns a string representing the <code>int</code> value.
<code>+valueOf(l: long): String</code>	Returns a string representing the <code>long</code> value.
<code>+valueOf(b: boolean): String</code>	Returns a string representing the <code>boolean</code> value.

FIGURE 9.9 The `String` class contains the static methods for creating strings from primitive type values.

For example, to convert a `double` value `5.44` to a string, use `String.valueOf(5.44)`. The return value is a string consisting of the characters `'5'`, `'.'`, `'4'`, and `'4'`.



Note

You can use `Double.parseDouble(str)` or `Integer.parseInt(str)` to convert a string to a `double` value or an `int` value. `Double` and `Integer` are two classes in the `java.lang` package.

9.2.11 Formatting Strings

The `String` class contains the static `format` method to create a formatted string. The syntax to invoke this method is:

```
String.format(format, item1, item2, ..., itemk)
```

This method is similar to the `printf` method except that the `format` method returns a formatted string, whereas the `printf` method displays a formatted string. For example,

```
String s = String.format("%7.2f%6d%-4s", 45.556, 14, "AB");
System.out.println(s);
```

displays

```
  45.56    14AB
```

Note that

```
System.out.printf(format, item1, item2, ..., itemk);
```

is equivalent to

```
System.out.printf(
    String.format(format, item1, item2, ..., itemk));
```

where the square box (□) denotes a blank space.

9.1 Suppose that **s1**, **s2**, **s3**, and **s4** are four strings, given as follows:

```
String s1 = "Welcome to Java";
String s2 = s1;
String s3 = new String("Welcome to Java");
String s4 = "Welcome to Java";
```

What are the results of the following expressions?

- | | |
|---|---|
| a. <code>s1 == s2</code> | m. <code>s1.length()</code> |
| b. <code>s2 == s3</code> | n. <code>s1.substring(5)</code> |
| c. <code>s1.equals(s2)</code> | o. <code>s1.substring(5, 11)</code> |
| d. <code>s2.equals(s3)</code> | p. <code>s1.startsWith("Wel")</code> |
| e. <code>s1.compareTo(s2)</code> | q. <code>s1.endsWith("Java")</code> |
| f. <code>s2.compareTo(s3)</code> | r. <code>s1.toLowerCase()</code> |
| g. <code>s1 == s4</code> | s. <code>s1.toUpperCase()</code> |
| h. <code>s1.charAt(0)</code> | t. <code>"Welcome ".trim()</code> |
| i. <code>s1.indexOf('j')</code> | u. <code>s1.replace('o', 'T')</code> |
| j. <code>s1.indexOf("to")</code> | v. <code>s1.replaceAll("o", "T")</code> |
| k. <code>s1.lastIndexOf('a')</code> | w. <code>s1.replaceFirst("o", "T")</code> |
| l. <code>s1.lastIndexOf("o", 15)</code> | x. <code>s1.toCharArray()</code> |

9.2 To create the string **Welcome to Java**, you may use a statement like this:

```
String s = "Welcome to Java";
```

or:

```
String s = new String("Welcome to Java");
```

Which one is better? Why?

9.3 Suppose that **s1** and **s2** are two strings. Which of the following statements or expressions are incorrect?

```
String s = new String("new string");
String s3 = s1 + s2;
String s3 = s1 - s2;
s1 == s2;
s1 >= s2;
s1.compareTo(s2);
int i = s1.length();
char c = s1(0);
char c = s1.charAt(s1.length());
```

9.4 What is the printout of the following code?

```
String s1 = "Welcome to Java";
String s2 = s1.replace("o", "abc");
System.out.println(s1);
System.out.println(s2);
```



- 9.5** Let `s1` be "Welcome" and `s2` be "welcome". Write the code for the following statements:
- Check whether `s1` is equal to `s2` and assign the result to a Boolean variable `isEqual`.
 - Check whether `s1` is equal to `s2`, ignoring case, and assign the result to a Boolean variable `isEqual`.
 - Compare `s1` with `s2` and assign the result to an `int` variable `x`.
 - Compare `s1` with `s2`, ignoring case, and assign the result to an `int` variable `x`.
 - Check whether `s1` has the prefix `AAA` and assign the result to a Boolean variable `b`.
 - Check whether `s1` has the suffix `AAA` and assign the result to a Boolean variable `b`.
 - Assign the length of `s1` to an `int` variable `x`.
 - Assign the first character of `s1` to a `char` variable `x`.
 - Create a new string `s3` that combines `s1` with `s2`.
 - Create a substring of `s1` starting from index `1`.
 - Create a substring of `s1` from index `1` to index `4`.
 - Create a new string `s3` that converts `s1` to lowercase.
 - Create a new string `s3` that converts `s1` to uppercase.
 - Create a new string `s3` that trims blank spaces on both ends of `s1`.
 - Replace all occurrences of the character `e` with `E` in `s1` and assign the new string to `s3`.
 - Split `Welcome to Java and HTML` into an array `tokens` delimited by a space.
 - Assign the index of the first occurrence of the character `e` in `s1` to an `int` variable `x`.
 - Assign the index of the last occurrence of the string `abc` in `s1` to an `int` variable `x`.
- 9.6** Does any method in the `String` class change the contents of the string?
- 9.7** Suppose string `s` is created using `new String()`; what is `s.length()`?
- 9.8** How do you convert a `char`, an array of characters, or a number to a string?
- 9.9** Why does the following code cause a `NullPointerException`?

```

1 public class Test {
2     private String text;
3
4     public Test(String s) {
5         String text = s;
6     }
7
8     public static void main(String[] args) {
9         Test test = new Test("ABC");
10        System.out.println(test.text.toLowerCase());
11    }
12 }

```

- 9.10** What is wrong in the following program?

```

1 public class Test {
2     String text;
3

```

```

4  public void Test(String s) {
5      text = s;
6  }
7
8  public static void main(String[] args) {
9      Test test = new Test("ABC");
10     System.out.println(test);
11 }
12 }

```

9.11 Show the output of the following code.

```

public class Test {
    public static void main(String[] args) {
        System.out.println("Hi, ABC, good".matches("ABC "));
        System.out.println("Hi, ABC, good".matches(".*ABC.*"));
        System.out.println("A,B;C".replaceAll(";", "#"));
        System.out.println("A,B;C".replaceAll("[,;]", "#"));

        String[] tokens = "A,B;C".split("[,;]");
        for (int i = 0; i < tokens.length; i++)
            System.out.print(tokens[i] + " ");
    }
}

```

9.3 Case Study: Checking Palindromes

This section presents a program that checks whether a string is a palindrome.

A string is a palindrome if it reads the same forward and backward. The words “mom,” “dad,” and “noon,” for instance, are all palindromes.

The problem is to write a program that prompts the user to enter a string and reports whether the string is a palindrome. One solution is to check whether the first character in the string is the same as the last character. If so, check whether the second character is the same as the second-to-last character. This process continues until a mismatch is found or all the characters in the string are checked, except for the middle character if the string has an odd number of characters.

To implement this idea, use two variables, say **low** and **high**, to denote the position of the two characters at the beginning and the end in a string **s**, as shown in Listing 9.1 (lines 22, 25). Initially, **low** is **0** and **high** is **s.length() - 1**. If the two characters at these positions match, increment **low** by **1** and decrement **high** by **1** (lines 31–32). This process continues until (**low** >= **high**) or a mismatch is found.

LISTING 9.1 CheckPalindrome.java

```

1  import java.util.Scanner;
2
3  public class CheckPalindrome {
4      /** Main method */
5      public static void main(String[] args) {
6          // Create a Scanner
7          Scanner input = new Scanner(System.in);
8
9          // Prompt the user to enter a string
10         System.out.print("Enter a string: ");
11         String s = input.nextLine();
12
13         if (isPalindrome(s))

```



VideoNote

Check palindrome

input string

```

14     System.out.println(s + " is a palindrome");
15     else
16         System.out.println(s + " is not a palindrome");
17 }
18
19 /** Check if a string is a palindrome */
20 public static boolean isPalindrome(String s) {
21     // The index of the first character in the string
22     int low = 0;
23
24     // The index of the last character in the string
25     int high = s.length() - 1;
26
27     while (low < high) {
28         if (s.charAt(low) != s.charAt(high))
29             return false; // Not a palindrome
30
31         low++;
32         high--;
33     }
34
35     return true; // The string is a palindrome
36 }
37 }

```

low index

high index

update indices



Enter a string: noon
 noon is a palindrome



Enter a string: moon
 moon is not a palindrome

The `nextLine()` method in the `Scanner` class (line 11) reads a line into `s`, and then `isPalindrome(s)` checks whether `s` is a palindrome (line 13).

9.4 Case Study: Converting Hexadecimals to Decimals



This section presents a program that converts a hexadecimal number into a decimal number.

Section 5.7 gives a program that converts a decimal to a hexadecimal. How do you convert a hex number into a decimal?

Given a hexadecimal number $h_n h_{n-1} h_{n-2} \dots h_2 h_1 h_0$, the equivalent decimal value is

$$h_n \times 16^n + h_{n-1} \times 16^{n-1} + h_{n-2} \times 16^{n-2} + \dots + h_2 \times 16^2 + h_1 \times 16^1 + h_0 \times 16^0$$

For example, the hex number **AB8C** is

$$10 \times 16^3 + 11 \times 16^2 + 8 \times 16^1 + 12 \times 16^0 = 43916$$

Our program will prompt the user to enter a hex number as a string and convert it into a decimal using the following method:

```
public static int hexToDecimal(String hex)
```

A brute-force approach is to convert each hex character into a decimal number, multiply it by 16^i for a hex digit at the `i`'s position, and then add all the items together to obtain the equivalent decimal value for the hex number.

Note that

$$h_n \times 16^n + h_{n-1} \times 16^{n-1} + h_{n-2} \times 16^{n-2} + \dots + h_1 \times 16^1 + h_0 \times 16^0$$

$$= (\dots ((h_n \times 16 + h_{n-1}) \times 16 + h_{n-2}) \times 16 + \dots + h_1) \times 16 + h_0$$

This observation, known as the Horner's algorithm, leads to the following efficient code for converting a hex string to a decimal number:

```
int decimalValue = 0;
for (int i = 0; i < hex.length(); i++) {
    char hexChar = hex.charAt(i);
    decimalValue = decimalValue * 16 + hexCharToDecimal(hexChar);
}
```

Here is a trace of the algorithm for hex number **AB8C**:

	i	hexChar	hexCharToDecimal(hexChar)	decimalValue
before the loop				0
after the 1st iteration	0	A	10	10
after the 2nd iteration	1	B	11	10 * 16 + 11
after the 3rd iteration	2	8	8	(10 * 16 + 11) * 16 + 8
after the 4th iteration	3	C	12	((10 * 16 + 11) * 16 + 8) * 16 + 12



Listing 9.2 gives the complete program.

LISTING 9.2 HexToDecimalConversion.java

```
1 import java.util.Scanner;
2
3 public class HexToDecimalConversion {
4     /** Main method */
5     public static void main(String[] args) {
6         // Create a Scanner
7         Scanner input = new Scanner(System.in);
8
9         // Prompt the user to enter a string
10        System.out.print("Enter a hex number: ");
11        String hex = input.nextLine();
12
13        System.out.println("The decimal value for hex number "
14            + hex + " is " + hexToDecimal(hex.toUpperCase()));
15    }
16
17    public static int hexToDecimal(String hex) {
18        int decimalValue = 0;
19        for (int i = 0; i < hex.length(); i++) {
20            char hexChar = hex.charAt(i);
21            decimalValue = decimalValue * 16 + hexCharToDecimal(hexChar);
22        }
23
24        return decimalValue;
25    }
26}
```

hex char to decimal
to uppercase

```

27 public static int hexCharToDecimal(char ch) {
28     if (ch >= 'A' && ch <= 'F')
29         return 10 + ch - 'A';
30     else // ch is '0', '1', ..., or '9'
31         return ch - '0';
32     }
33 }

```



```

Enter a hex number: AB8C ↵ Enter
The decimal value for hex number AB8C is 43916

```



```

Enter a hex number: af71 ↵ Enter
The decimal value for hex number af71 is 44913

```

The program reads a string from the console (line 11), and invokes the `hexToDecimal` method to convert a hex string to decimal number (line 14). The characters can be in either lowercase or uppercase. They are converted to uppercase before invoking the `hexToDecimal` method.

The `hexToDecimal` method is defined in lines 17–25 to return an integer. The length of the string is determined by invoking `hex.length()` in line 19.

The `hexCharToDecimal` method is defined in lines 27–32 to return a decimal value for a hex character. The character can be in either lowercase or uppercase. Recall that to subtract two characters is to subtract their Unicodes. For example, `'5' - '0'` is 5.

9.5 The Character Class



Key
Point

You can create an object for a character using the `Character` class. A `Character` object contains a character value.

Many methods in the Java API require an object argument. To enable the primitive data values to be treated as objects, Java provides a class for every primitive data type. These classes are `Character`, `Boolean`, `Byte`, `Short`, `Integer`, `Long`, `Float`, and `Double` for `char`, `boolean`, `byte`, `short`, `int`, `long`, `float`, and `double`, respectively. These classes are called *wrapper classes* because each wraps or encapsulates a primitive type value in an object. All these classes are in the `java.lang` package, and they contain useful methods for processing primitive values. This section introduces the `Character` class. The other wrapper classes will be introduced in Chapter 10, Thinking in Objects.

The `Character` class has a constructor and several methods for determining a character's category (uppercase, lowercase, digit, and so on) and for converting characters from uppercase to lowercase, and vice versa, as shown in Figure 9.10.

You can create a `Character` object from a `char` value. For example, the following statement creates a `Character` object for the character `a`.

```
Character character = new Character('a');
```

The `charValue` method returns the character value wrapped in the `Character` object. The `compareTo` method compares this character with another character and returns an integer that is the difference between the Unicode of this character and the Unicode of the other character. The `equals` method returns `true` if and only if the two characters are the same. For example, suppose `charObject` is `new Character('b')`:

```

charObject.compareTo(new Character('a')) returns 1
charObject.compareTo(new Character('b')) returns 0
charObject.compareTo(new Character('c')) returns -1

```

wrapper class

```

charObject.compareTo(new Character('d')) returns -2
charObject.equals(new Character('b')) returns true
charObject.equals(new Character('d')) returns false

```

java.lang.Character	
<pre> +Character(value: char) +charValue(): char +compareTo(anotherCharacter: Character): int +equals(anotherCharacter: Character): boolean +isDigit(ch: char): boolean +isLetter(ch: char): boolean +isLetterOrDigit(ch: char): boolean +isLowerCase(ch: char): boolean +isUpperCase(ch: char): boolean +toLowerCase(ch: char): char +toUpperCase(ch: char): char </pre>	<pre> Constructs a character object with char value. Returns the char value from this object. Compares this character with another. Returns true if this character is equal to another. Returns true if the specified character is a digit. Returns true if the specified character is a letter. Returns true if the character is a letter or a digit. Returns true if the character is a lowercase letter. Returns true if the character is an uppercase letter. Returns the lowercase of the specified character. Returns the uppercase of the specified character. </pre>

FIGURE 9.10 The **Character** class provides the methods for manipulating a character.

Most of the methods in the **Character** class are static methods. The **isDigit(char ch)** method returns **true** if the character is a digit, and the **isLetter(char ch)** method returns **true** if the character is a letter. The **isLetterOrDigit(char ch)** method returns **true** if the character is a letter or a digit. The **isLowerCase(char ch)** method returns **true** if the character is a lowercase letter, and the **isUpperCase(char ch)** method returns **true** if the character is an uppercase letter. The **toLowerCase(char ch)** method returns the lowercase letter for the character, and the **toUpperCase(char ch)** method returns the uppercase letter for the character.

Now let's write a program that prompts the user to enter a string and counts the number of occurrences of each letter in the string regardless of case.

Here are the steps to solve this problem:

1. Convert all the uppercase letters in the string to lowercase using the **toLowerCase** method in the **String** class.
2. Create an array, say **counts** of **26 int** values, each of which counts the occurrences of a letter. That is, **counts[0]** counts the number of **as**, **counts[1]** counts the number of **bs**, and so on.
3. For each character in the string, check whether it is a (lowercase) letter. If so, increment the corresponding count in the array.

Listing 9.3 gives the complete program.

LISTING 9.3 CountEachLetter.java

```

1 import java.util.Scanner;
2
3 public class CountEachLetter {
4     /** Main method */
5     public static void main(String[] args) {
6         // Create a Scanner
7         Scanner input = new Scanner(System.in);
8

```

```

9      // Prompt the user to enter a string
10     System.out.print("Enter a string: ");
input string 11     String s = input.nextLine();
12
13     // Invoke the countLetters method to count each letter
count letters 14     int[] counts = countLetters(s.toLowerCase());
15
16     // Display results
17     for (int i = 0; i < counts.length; i++) {
18         if (counts[i] != 0)
19             System.out.println((char)('a' + i) + " appears " +
20                 counts[i] + ((counts[i] == 1) ? " time" : " times"));
21     }
22 }
23
24 /** Count each letter in the string */
25 public static int[] countLetters(String s) {
26     int[] counts = new int[26];
27
28     for (int i = 0; i < s.length(); i++) {
29         if (Character.isLetter(s.charAt(i)))
30             counts[s.charAt(i) - 'a']++;
31     }
32
33     return counts;
34 }
35 }

```

count a letter



```

Enter a string: abababx  → Enter
a appears 3 times
b appears 3 times
x appears 1 time

```

The main method reads a line (line 11) and counts the number of occurrences of each letter in the string by invoking the `countLetters` method (line 14). Since the case of the letters is ignored, the program uses the `toLowerCase` method to convert the string into all lowercase and pass the new string to the `countLetters` method.

The `countLetters` method (lines 25–34) returns an array of 26 elements. Each element counts the number of occurrences of a letter in the string `s`. The method processes each character in the string. If the character is a letter, its corresponding count is increased by 1. For example, if the character (`s.charAt(i)`) is `a`, the corresponding count is `counts['a' - 'a']` (i.e., `counts[0]`). If the character is `b`, the corresponding count is `counts['b' - 'a']` (i.e., `counts[1]`), since the Unicode of `b` is 1 more than that of `a`. If the character is `z`, the corresponding count is `counts['z' - 'a']` (i.e., `counts[25]`), since the Unicode of `z` is 25 more than that of `a`.



9.12 How do you determine whether a character is in lowercase or uppercase?

9.13 How do you determine whether a character is alphanumeric?

9.14 Show the output of the following code.

```

public class Test {
    public static void main(String[] args) {
        String s = "Hi, Good Morning";
        System.out.println(m(s));
    }
}

```

```

public static int m(String s) {
    int count = 0;
    for (int i = 0; i < s.length(); i++)
        if (Character.toUpperCase(s.charAt(i)))
            count++;

    return count;
}

```

9.6 The `StringBuilder` and `StringBuffer` Classes

The `StringBuilder` and `StringBuffer` classes are similar to the `String` class except that the `String` class is immutable.



In general, the `StringBuilder` and `StringBuffer` classes can be used wherever a string is used. `StringBuilder` and `StringBuffer` are more flexible than `String`. You can add, insert, or append new contents into `StringBuilder` and `StringBuffer` objects, whereas the value of a `String` object is fixed once the string is created.

The `StringBuilder` class is similar to `StringBuffer` except that the methods for modifying the buffer in `StringBuffer` are *synchronized*, which means that only one task is allowed to execute the methods. Use `StringBuffer` if the class might be accessed by multiple tasks concurrently. Concurrent programming will be introduced in Chapter 32. Using `StringBuilder` is more efficient if it is accessed by just a single task. The constructors and methods in `StringBuffer` and `StringBuilder` are almost the same. This section covers `StringBuilder`. You can replace `StringBuilder` in all occurrences in this section by `StringBuffer`. The program can compile and run without any other changes.

`StringBuilder`

The `StringBuilder` class has three constructors and more than 30 methods for managing the builder and modifying strings in the builder. You can create an empty string builder or a string builder from a string using the constructors, as shown in Figure 9.11.

`StringBuilder`
constructors

java.lang.StringBuilder	
+StringBuilder()	Constructs an empty string builder with capacity 16.
+StringBuilder(capacity: int)	Constructs a string builder with the specified capacity.
+StringBuilder(s: String)	Constructs a string builder with the specified string.

FIGURE 9.11 The `StringBuilder` class contains the constructors for creating instances of `StringBuilder`.

9.6.1 Modifying Strings in the `StringBuilder`

You can append new contents at the end of a string builder, insert new contents at a specified position in a string builder, and delete or replace characters in a string builder, using the methods listed in Figure 9.12.

The `StringBuilder` class provides several overloaded methods to append `boolean`, `char`, `char[]`, `double`, `float`, `int`, `long`, and `String` into a string builder. For example, the following code appends strings and characters into `StringBuilder` to form a new string, `Welcome to Java`.

```

StringBuilder stringBuilder = new StringBuilder();
stringBuilder.append("Welcome");
stringBuilder.append(' ');
stringBuilder.append("to");
stringBuilder.append(' ');
stringBuilder.append("Java");

```

append

java.lang.StringBuilder	
<pre>+append(data: char[]): StringBuilder +append(data: char[], offset: int, len: int): StringBuilder +append(v: <i>aPrimitiveType</i>): StringBuilder +append(s: String): StringBuilder +delete(startIndex: int, endIndex: int): StringBuilder +deleteCharAt(index: int): StringBuilder +insert(index: int, data: char[], offset: int, len: int): StringBuilder +insert(offset: int, data: char[]): StringBuilder +insert(offset: int, b: <i>aPrimitiveType</i>): StringBuilder +insert(offset: int, s: String): StringBuilder +replace(startIndex: int, endIndex: int, s: String): StringBuilder +reverse(): StringBuilder +setCharAt(index: int, ch: char): void</pre>	<pre>Appends a char array into this string builder. Appends a subarray in data into this string builder. Appends a primitive type value as a string to this builder. Appends a string to this string builder. Deletes characters from startIndex to endIndex-1. Deletes a character at the specified index. Inserts a subarray of the data in the array into the builder at the specified index. Inserts data into this builder at the position offset. Inserts a value converted to a string into this builder. Inserts a string into this builder at the position offset. Replaces the characters in this builder from startIndex to endIndex-1 with the specified string. Reverses the characters in the builder. Sets a new character at the specified index in this builder.</pre>

FIGURE 9.12 The `StringBuilder` class contains the methods for modifying string builders.

The `StringBuilder` class also contains overloaded methods to insert `boolean`, `char`, `char array`, `double`, `float`, `int`, `long`, and `String` into a string builder. Consider the following code:

```
insert                stringBuilder.insert(11, "HTML and ");
```

Suppose `stringBuilder` contains `Welcome to Java` before the `insert` method is applied. This code inserts `"HTML and "` at position 11 in `stringBuilder` (just before the `J`). The new `stringBuilder` is `Welcome to HTML and Java`.

You can also delete characters from a string in the builder using the two `delete` methods, reverse the string using the `reverse` method, replace characters using the `replace` method, or set a new character in a string using the `setCharAt` method.

For example, suppose `stringBuilder` contains `Welcome to Java` before each of the following methods is applied:

<pre>delete deleteCharAt reverse replace setCharAt</pre>	<pre>stringBuilder.delete(8, 11) changes the builder to Welcome Java. stringBuilder.deleteCharAt(8) changes the builder to Welcome o Java. stringBuilder.reverse() changes the builder to avaJ ot emocleW. stringBuilder.replace(11, 15, "HTML") changes the builder to Welcome to HTML. stringBuilder.setCharAt(0, 'w') sets the builder to welcome to Java.</pre>
--	---

All these modification methods except `setCharAt` do two things:

- Change the contents of the string builder
- Return the reference of the string builder

ignore return value

For example, the following statement

```
StringBuilder stringBuilder1 = stringBuilder.reverse();
```

reverses the string in the builder and assigns the builder's reference to `stringBuilder1`. Thus, `stringBuilder` and `stringBuilder1` both point to the same `StringBuilder` object. Recall that a value-returning method can be invoked as a statement, if you are not interested in the return value of the method. In this case, the return value is simply ignored. For example, in the following statement

```
stringBuilder.reverse();
```

the return value is ignored.



Tip

If a string does not require any change, use `String` rather than `StringBuilder`. Java can perform some optimizations for `String`, such as sharing interned strings.

String or StringBuilder?

9.6.2 The `toString`, `capacity`, `length`, `setLength`, and `charAt` Methods

The `StringBuilder` class provides the additional methods for manipulating a string builder and obtaining its properties, as shown in Figure 9.13.

java.lang.StringBuilder	
+ <code>toString(): String</code>	Returns a string object from the string builder.
+ <code>capacity(): int</code>	Returns the capacity of this string builder.
+ <code>charAt(index: int): char</code>	Returns the character at the specified index.
+ <code>length(): int</code>	Returns the number of characters in this builder.
+ <code>setLength(newLength: int): void</code>	Sets a new length in this builder.
+ <code>substring(startIndex: int): String</code>	Returns a substring starting at <code>startIndex</code> .
+ <code>substring(startIndex: int, endIndex: int): String</code>	Returns a substring from <code>startIndex</code> to <code>endIndex-1</code> .
+ <code>trimToSize(): void</code>	Reduces the storage size used for the string builder.

FIGURE 9.13 The `StringBuilder` class contains the methods for modifying string builders.

The `capacity()` method returns the current capacity of the string builder. The capacity is the number of characters the string builder is able to store without having to increase its size. `capacity()`

The `length()` method returns the number of characters actually stored in the string builder. The `setLength(newLength)` method sets the length of the string builder. If the `newLength` argument is less than the current length of the string builder, the string builder is truncated to contain exactly the number of characters given by the `newLength` argument. If the `newLength` argument is greater than or equal to the current length, sufficient null characters (`\u0000`) are appended to the string builder so that `length` becomes the `newLength` argument. The `newLength` argument must be greater than or equal to 0. `length()` `setLength(int)`

The `charAt(index)` method returns the character at a specific `index` in the string builder. The index is 0 based. The first character of a string builder is at index 0, the next at index 1, and so on. The `index` argument must be greater than or equal to 0, and less than the length of the string builder. `charAt(int)`



Note

The length of the string is always less than or equal to the capacity of the builder. The length is the actual size of the string stored in the builder, and the capacity is the current size of the builder. The builder's capacity is automatically increased if more characters are added to exceed its capacity. Internally, a string builder is an array of characters, so

length and capacity

the builder's capacity is the size of the array. If the builder's capacity is exceeded, the array is replaced by a new array. The new array size is `2 * (the previous array size + 1)`.



Tip

You can use `new StringBuilder(initialCapacity)` to create a `StringBuilder` with a specified initial capacity. By carefully choosing the initial capacity, you can make your program more efficient. If the capacity is always larger than the actual length of the builder, the JVM will never need to reallocate memory for the builder. On the other hand, if the capacity is too large, you will waste memory space. You can use the `trimToSize()` method to reduce the capacity to the actual size.

initial capacity

`trimToSize()`

9.6.3 Case Study: Ignoring Nonalphanumeric Characters When Checking Palindromes

Listing 9.1, `CheckPalindrome.java`, considered all the characters in a string to check whether it was a palindrome. Write a new program that ignores nonalphanumeric characters in checking whether a string is a palindrome.

Here are the steps to solve the problem:

1. Filter the string by removing the nonalphanumeric characters. This can be done by creating an empty string builder, adding each alphanumeric character in the string to a string builder, and returning the string from the string builder. You can use the `isLetterOrDigit(ch)` method in the `Character` class to check whether character `ch` is a letter or a digit.
2. Obtain a new string that is the reversal of the filtered string. Compare the reversed string with the filtered string using the `equals` method.

The complete program is shown in Listing 9.4.

LISTING 9.4 `PalindromeIgnoreNonAlphanumeric.java`

```

1  import java.util.Scanner;
2
3  public class PalindromeIgnoreNonAlphanumeric {
4      /** Main method */
5      public static void main(String[] args) {
6          // Create a Scanner
7          Scanner input = new Scanner(System.in);
8
9          // Prompt the user to enter a string
10         System.out.print("Enter a string: ");
11         String s = input.nextLine();
12
13         // Display result
14         System.out.println("Ignoring nonalphanumeric characters, \nis "
15             + s + " a palindrome? " + isPalindrome(s));
16     }
17
18     /** Return true if a string is a palindrome */
19     public static boolean isPalindrome(String s) {
20         // Create a new string by eliminating nonalphanumeric chars
21         String s1 = filter(s);
22
23         // Create a new string that is the reversal of s1
24         String s2 = reverse(s1);
25
26         // Check if the reversal is the same as the original string

```

check palindrome


```

27     return s2.equals(s1);
28 }
29
30 /** Create a new string by eliminating nonalphanumeric chars */
31 public static String filter(String s) {
32     // Create a string builder
33     StringBuilder stringBuilder = new StringBuilder();
34
35     // Examine each char in the string to skip alphanumeric char
36     for (int i = 0; i < s.length(); i++) {
37         if (Character.isLetterOrDigit(s.charAt(i))) {
38             stringBuilder.append(s.charAt(i));
39         }
40     }
41
42     // Return a new filtered string
43     return stringBuilder.toString();
44 }
45
46 /** Create a new string by reversing a specified string */
47 public static String reverse(String s) {
48     StringBuilder stringBuilder = new StringBuilder(s);
49     stringBuilder.reverse(); // Invoke reverse in StringBuilder
50     return stringBuilder.toString();
51 }
52 }

```

add letter or digit

```

Enter a string: ab<c>cb?a ↵
Ignoring nonalphanumeric characters,
is ab<c>cb?a a palindrome? true

```



```

Enter a string: abcc<?cab ↵
Ignoring nonalphanumeric characters,
is abcc<?cab a palindrome? false

```



The **filter(String s)** method (lines 31–44) examines each character in string **s** and copies it to a string builder if the character is a letter or a numeric character. The **filter** method returns the string in the builder. The **reverse(String s)** method (lines 47–51) creates a new string that reverses the specified string **s**. The **filter** and **reverse** methods both return a new string. The original string is not changed.

The program in Listing 9.1 checks whether a string is a palindrome by comparing pairs of characters from both ends of the string. Listing 9.4 uses the **reverse** method in the **StringBuilder** class to reverse the string, then compares whether the two strings are equal to determine whether the original string is a palindrome.

- 9.15** What is the difference between **StringBuilder** and **StringBuffer**?
- 9.16** How do you create a string builder from a string? How do you return a string from a string builder?
- 9.17** Write three statements to reverse a string **s** using the **reverse** method in the **StringBuilder** class.
- 9.18** Write three statements to delete a substring from a string **s** of 20 characters, starting at index 4 and ending with index 10. Use the **delete** method in the **StringBuilder** class.
- 9.19** What is the internal storage for characters in a string and a string builder?



9.20 Suppose that `s1` and `s2` are given as follows:

```
StringBuilder s1 = new StringBuilder("Java");
StringBuilder s2 = new StringBuilder("HTML");
```

Show the value of `s1` after each of the following statements. Assume that the statements are independent.

- | | |
|---|---|
| a. <code>s1.append(" is fun");</code> | g. <code>s1.deleteCharAt(3);</code> |
| b. <code>s1.append(s2);</code> | h. <code>s1.delete(1, 3);</code> |
| c. <code>s1.insert(2, "is fun");</code> | i. <code>s1.reverse();</code> |
| d. <code>s1.insert(1, s2);</code> | j. <code>s1.replace(1, 3, "Computer");</code> |
| e. <code>s1.charAt(2);</code> | k. <code>s1.substring(1, 3);</code> |
| f. <code>s1.length();</code> | l. <code>s1.substring(2);</code> |

9.21 Show the output of the following program:

```
public class Test {
    public static void main(String[] args) {
        String s = "Java";
        StringBuilder builder = new StringBuilder(s);
        change(s, builder);

        System.out.println(s);
        System.out.println(builder);
    }

    private static void change(String s, StringBuilder builder) {
        s = s + " and HTML";
        builder.append(" and HTML");
    }
}
```

9.7 Command-Line Arguments



The `main` method can receive string arguments from the command line.

Perhaps you have already noticed the unusual header for the `main` method, which has the parameter `args` of `String[]` type. It is clear that `args` is an array of strings. The `main` method is just like a regular method with a parameter. You can call a regular method by passing actual parameters. Can you pass arguments to `main`? Yes, of course you can. In the following examples, the `main` method in class `TestMain` is invoked by a method in `A`.

```
public class A {
    public static void main(String[] args) {
        String[] strings = {"New York",
            "Boston", "Atlanta"};
        TestMain.main(strings);
    }
}
```

```
public class TestMain {
    public static void main(String[] args) {
        for (int i = 0; i < args.length; i++)
            System.out.println(args[i]);
    }
}
```

A `main` method is just a regular method. Furthermore, you can pass arguments from the command line.

9.7.1 Passing Strings to the `main` Method

You can pass strings to a `main` method from the command line when you run the program. The following command line, for example, starts the program `TestMain` with three strings: `arg0`, `arg1`, and `arg2`:

```
java TestMain arg0 arg1 arg2
```

`arg0`, `arg1`, and `arg2` are strings, but they don't have to appear in double quotes on the command line. The strings are separated by a space. A string that contains a space must be enclosed in double quotes. Consider the following command line:

```
java TestMain "First num" alpha 53
```

It starts the program with three strings: `First num`, `alpha`, and `53`. Since `First num` is a string, it is enclosed in double quotes. Note that `53` is actually treated as a string. You can use `"53"` instead of `53` in the command line.

When the `main` method is invoked, the Java interpreter creates an array to hold the command-line arguments and pass the array reference to `args`. For example, if you invoke a program with `n` arguments, the Java interpreter creates an array like this one:

```
args = new String[n];
```

The Java interpreter then passes `args` to invoke the `main` method.



Note

If you run the program with no strings passed, the array is created with `new String[0]`. In this case, the array is empty with length `0`. `args` references to this empty array. Therefore, `args` is not `null`, but `args.length` is `0`.

9.7.2 Case Study: Calculator

Suppose you are to develop a program that performs arithmetic operations on integers. The program receives an expression in one string argument. The expression consists of an integer followed by an operator and another integer. For example, to add two integers, use this command:

```
java Calculator "2 + 3"
```

The program will display the following output:

```
2 + 3 = 5
```

Figure 9.14 shows sample runs of the program.

The strings passed to the main program are stored in `args`, which is an array of strings. In this case, we pass the expression as one string. Therefore, the array contains only one element in `args[0]` and `args.length` is `1`.

Here are the steps in the program:

1. Use `args.length` to determine whether the expression has been provided as one argument in the command line. If not, terminate the program using `System.exit(1)`.
2. Split the expression in the string `args[0]` into three tokens in `tokens[0]`, `tokens[1]`, and `tokens[2]`.
3. Perform a binary arithmetic operation on the operands `tokens[0]` and `tokens[2]` using the operator in `tokens[1]`.



VideoNote

Command-line argument

```

Administrator: Command Prompt
c:\book>java Calculator
Usage: java Calculator "operand1 operator operand2"

Add -> c:\book>java Calculator "63 + 40"
      63 + 40 = 103

Subtract -> c:\book>java Calculator "63 - 40"
          63 - 40 = 23

Multiply -> c:\book>java Calculator "63 * 40"
          63 * 40 = 2520

Divide -> c:\book>java Calculator "63 / 40"
          63 / 40 = 1

c:\book>

```

FIGURE 9.14 The program takes an expression in one argument (**operand1 operator operand2**) from the command line and displays the expression and the result of the arithmetic operation.

The program is shown in Listing 9.5.

LISTING 9.5 Calculator.java

```

1 public class Calculator {
2     /** Main method */
3     public static void main(String[] args) {
4         // Check number of strings passed
5         if (args.length != 1) {
6             System.out.println(
7                 "Usage: java Calculator \"operand1 operator operand2\"");
8             System.exit(1);
9         }
10
11         // The result of the operation
12         int result = 0;
13
14         // The result of the operation
15         String[] tokens = args[0].split(" ");
16
17         // Determine the operator
18         switch (tokens[1].charAt(0)) {
19             case '+': result = Integer.parseInt(tokens[0]) +
20                     Integer.parseInt(tokens[2]);
21             break;
22             case '-': result = Integer.parseInt(tokens[0]) -
23                     Integer.parseInt(tokens[2]);
24             break;
25             case '*': result = Integer.parseInt(tokens[0]) *
26                     Integer.parseInt(tokens[2]);
27             break;
28             case '/': result = Integer.parseInt(tokens[0]) /
29                     Integer.parseInt(tokens[2]);
30         }
31
32         // Display result
33         System.out.println(tokens[0] + ' ' + tokens[1] + ' '
34             + tokens[2] + " = " + result);
35     }
36 }

```

check argument

split string

check operator

The expression is passed as a string in one argument and it is split into three parts—`tokens[0]`, `tokens[1]`, and `tokens[2]`—using the `split` method (line 15) with a space as a delimiter.

`Integer.parseInt(tokens[0])` (line 19) converts a digital string into an integer. The string must consist of digits. If it doesn't, the program will terminate abnormally.

For this program to work, the expression must be entered in the form of “operand1 operator operand2”. The operands and operator are separated by exactly one space. You can modify the program to accept the expressions in different forms (see Programming Exercise 9.28).

9.22 This book declares the `main` method as

```
public static void main(String[] args)
```

Can it be replaced by one of the following lines?

```
public static void main(String args[])
public static void main(String[] x)
public static void main(String x[])
static void main(String x[])
```

9.23 Show the output of the following program when invoked using

1. `java Test I have a dream`
2. `java Test "1 2 3"`
3. `java Test`

```
public class Test {
    public static void main(String[] args) {
        System.out.println("Number of strings is " + args.length);
        for (int i = 0; i < args.length; i++)
            System.out.println(args[i]);
    }
}
```

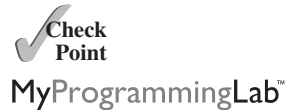
KEY TERMS

interned string 337

wrapper class 350

CHAPTER SUMMARY

1. Strings are objects encapsulated in the `String` class. A string can be constructed using one of the 13 constructors or simply using a string literal. Java treats a string literal as a `String` object.
2. A `String` object is immutable; its contents cannot be changed. To improve efficiency and save memory, the JVM stores two literal strings that have the same character sequence in a unique object. This unique object is called an *interned string object*.
3. You can get the length of a string by invoking its `length()` method, retrieve a character at the specified `index` in the string using the `charAt(index)` method, and use the `indexOf` and `lastIndexOf` methods to find a character or a substring in a string.



4. You can use the **concat** method to concatenate two strings, or the plus (+) operator to concatenate two or more strings.
5. You can use the **substring** method to obtain a substring from the string.
6. You can use the **equals** and **compareTo** methods to compare strings. The **equals** method returns **true** if two strings are equal, and **false** if they are not equal. The **compareTo** method returns **0**, a positive integer, or a negative integer, depending on whether one string is equal to, greater than, or less than the other string.
7. A *regular expression* (abbreviated *regex*) is a string that describes a pattern for matching a set of strings. You can match, replace, or split a string by specifying a pattern.
8. The **Character** class is a wrapper class for a single character. The **Character** class provides useful static methods to determine whether a character is a letter (**isLetter(char)**), a digit (**isDigit(char)**), uppercase (**isUpperCase(char)**), or lowercase (**isLowerCase(char)**).
9. The **StringBuilder** and **StringBuffer** classes can be used to replace the **String** class. The **String** object is immutable, but you can add, insert, or append new contents into **StringBuilder** and **StringBuffer** objects. Use **String** if the string contents do not require any change, and use **StringBuilder** or **StringBuffer** if they might change.
10. You can pass strings to the **main** method from the command line. Strings passed to the **main** program are stored in **args**, which is an array of strings. The first string is represented by **args[0]**, and **args.length** is the number of strings passed.

TEST QUESTIONS

Do the test questions for this chapter online at www.cs.armstrong.edu/liang/intro9e/test.html.

MyProgrammingLab™

PROGRAMMING EXERCISES

Sections 9.2–9.3

- *9.1** (*Check SSN*) Write a program that prompts the user to enter a Social Security number in the format DDD-DD-DDDD, where D is a digit. The program displays **Valid SSN** for a correct Social Security number and **Invalid SSN** otherwise.
- **9.2** (*Check substrings*) You can check whether a string is a substring of another string by using the **indexOf** method in the **String** class. Write your own method for this function. Write a program that prompts the user to enter two strings, and checks whether the first string is a substring of the second.
- **9.3** (*Check password*) Some websites impose certain rules for passwords. Write a method that checks whether a string is a valid password. Suppose the password rules are as follows:
- A password must have at least eight characters.
 - A password consists of only letters and digits.
 - A password must contain at least two digits.

Write a program that prompts the user to enter a password and displays **Valid Password** if the rules are followed or **Invalid Password** otherwise.

- 9.4** (*Occurrences of a specified character*) Write a method that finds the number of occurrences of a specified character in a string using the following header:

```
public static int count(String str, char a)
```

For example, `count("Welcome", 'e')` returns `2`. Write a test program that prompts the user to enter a string followed by a character and displays the number of occurrences of the character in the string.

- **9.5** (*Occurrences of each digit in a string*) Write a method that counts the occurrences of each digit in a string using the following header:

```
public static int[] count(String s)
```

The method counts how many times a digit appears in the string. The return value is an array of ten elements, each of which holds the count for a digit. For example, after executing `int[] counts = count("12203AB3")`, `counts[0]` is `1`, `counts[1]` is `1`, `counts[2]` is `2`, and `counts[3]` is `2`.

Write a test program that prompts the user to enter a string and displays the number of occurrences of each digit in the string.

- *9.6** (*Count the letters in a string*) Write a method that counts the number of letters in a string using the following header:

```
public static int countLetters(String s)
```

Write a test program that prompts the user to enter a string and displays the number of letters in the string.

- *9.7** (*Phone keypads*) The international standard letter/number mapping found on the telephone is:

1	2 ABC	3 DEF
4 GHI	5 JKL	6 MNO
7 PQRS	8 TUV	9 WXYZ
	0	

Write a method that returns a number, given an uppercase letter, as follows:

```
public static int getNumber(char uppercaseLetter)
```

Write a test program that prompts the user to enter a phone number as a string. The input number may contain letters. The program translates a letter (upper- or lower-case) to a digit and leaves all other characters intact. Here is a sample run of the program:

```
Enter a string: 1-800-Flowers →Enter
1-800-3569377
```





```
Enter a string: 1800flowers
18003569377
```

- *9.8** (*Binary to decimal*) Write a method that parses a binary number as a string into a decimal integer. The method header is:

```
public static int binaryToDecimal(String binaryString)
```

For example, binary string 10001 is 17 ($1 \times 2^4 + 0 \times 2^3 + 0 \times 2^2 + 0 \times 2 + 1 = 17$). Therefore, `binaryToDecimal("10001")` returns `17`. Note that `Integer.parseInt("10001", 2)` parses a binary string to a decimal value. Do not use this method in this exercise.

Write a test program that prompts the user to enter a binary string and displays the corresponding decimal integer value.

Section 9.4

- **9.9** (*Binary to hex*) Write a method that parses a binary number into a hex number. The method header is:

```
public static String binaryToHex(String binaryValue)
```

Write a test program that prompts the user to enter a binary number and displays the corresponding hexadecimal value.

- **9.10** (*Decimal to binary*) Write a method that parses a decimal number into a binary number as a string. The method header is:

```
public static String decimalToBinary(int value)
```

Write a test program that prompts the user to enter a decimal integer value and displays the corresponding binary value.

- **9.11** (*Sort characters in a string*) Write a method that returns a sorted string using the following header:

```
public static String sort(String s)
```

For example, `sort("acb")` returns `abc`.

Write a test program that prompts the user to enter a string and displays the sorted string.

- **9.12** (*Anagrams*) Write a method that checks whether two words are anagrams. Two words are anagrams if they contain the same letters in any order. For example, `silent` and `listen` are anagrams. The header of the method is:

```
public static boolean isAnagram(String s1, String s2)
```

Write a test program that prompts the user to enter two strings and, if they are anagrams, displays `two strings are anagrams`, and displays `two strings are not anagrams` if they are not anagrams.

Section 9.5

- *9.13** (*Pass a string to check palindromes*) Rewrite Listing 9.1 by passing the string as a command-line argument.

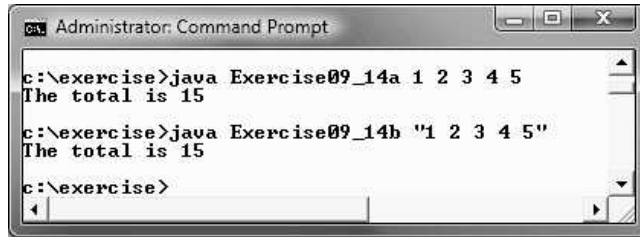
- *9.14** (*Sum integers*) Write two programs. The first program passes an unspecified number of integers as separate strings to the `main` method and displays their total. The



VideoNote

Number conversion

second program passes an unspecified number of integers delimited by one space in a string to the `main` method and displays their total. Name the two programs `Exercise9_14a` and `Exercise9_14b`, as shown in Figure 9.15.



```

Administrator: Command Prompt
c:\exercise>java Exercise09_14a 1 2 3 4 5
The total is 15
c:\exercise>java Exercise09_14b "1 2 3 4 5"
The total is 15
c:\exercise>

```

FIGURE 9.15 The program adds all the numbers passed from the command line.

- *9.15** (*Find the number of uppercase letters in a string*) Write a program that passes a string to the `main` method and displays the number of uppercase letters in the string.

Comprehensive

- **9.16** (*Implement the `String` class*) The `String` class is provided in the Java library. Provide your own implementation for the following methods (name the new class `MyString1`):

```

public MyString1(char[] chars);
public char charAt(int index);
public int length();
public MyString1 substring(int begin, int end);
public MyString1 toLowerCase();
public boolean equals(MyString1 s);
public static MyString1 valueOf(int i);

```

- **9.17** (*Guess the capitals*) Write a program that repeatedly prompts the user to enter a capital for a state. Upon receiving the user input, the program reports whether the answer is correct. Assume that 50 states and their capitals are stored in a two-dimensional array, as shown in Figure 9.16. The program prompts the user to answer all states' capitals and displays the total correct count. The user's answer is not case-sensitive.

Alabama	Montgomery
Alaska	Juneau
Arizona	Phoenix
...	...
...	...

FIGURE 9.16 A two-dimensional array stores states and their capitals.

Here is a sample run:

```

What is the capital of Alabama? Montgomery ↵Enter
The correct answer should be Montgomery
What is the capital of Alaska? Juneau ↵Enter
Your answer is correct
What is the capital of Arizona? ...
...
The correct count is 35

```



- **9.18** (Implement the *String* class) The *String* class is provided in the Java library. Provide your own implementation for the following methods (name the new class *MyString2*):

```
public MyString2(String s);
public int compare(String s);
public MyString2 substring(int begin);
public MyString2 toUpperCase();
public char[] toChars();
public static MyString2 valueOf(boolean b);
```

- *9.19** (Common prefix) Write a method that returns the longest common prefix of two strings. For example, the longest common prefix of *distance* and *disinfection* is *dis*. The header of the method is:

```
public static String prefix(String s1, String s2)
```

If the two strings don't have a common prefix, the method returns an empty string. Write a *main* method that prompts the user to enter two strings and displays their longest common prefix.

- 9.20** (Implement the *Character* class) The *Character* class is provided in the Java library. Provide your own implementation for this class. Name the new class *MyCharacter*.

- **9.21** (New string *split* method) The *split* method in the *String* class returns an array of strings consisting of the substrings split by the delimiters. However, the delimiters are not returned. Implement the following new method that returns an array of strings consisting of the substrings split by the matching delimiters, including the matching delimiters.

```
public static String[] split(String s, String regex)
```

For example, *split("ab#12#453", "#")* returns *ab, #, 12, #, 453* in an array of *String*, and *split("a?b?gf#e", "[?#]")* returns *a, b, ?, b, gf, #, and e* in an array of *String*.

- **9.22** (Implement the *StringBuilder* class) The *StringBuilder* class is provided in the Java library. Provide your own implementation for the following methods (name the new class *MyStringBuilder1*):

```
public MyStringBuilder1(String s);
public MyStringBuilder1 append(MyStringBuilder1 s);
public MyStringBuilder1 append(int i);
public int length();
public char charAt(int index);
public MyStringBuilder1 toLowerCase();
public MyStringBuilder1 substring(int begin, int end);
public String toString();
```

- **9.23** (Financial: credit card number validation) Rewrite Programming Exercise 5.31 using a string input for the credit card number. Redesign the program using the following methods:

```
/** Return true if the card number is valid */
public static boolean isValid(String cardNumber)

/** Get the result from Step 2 */
public static int sumOfDoubleEvenPlace(String cardNumber)
```

```

    /** Return this number if it is a single digit; otherwise,
     * return the sum of the two digits */
    public static int getDigit(int number)

    /** Return sum of odd-place digits in number */
    public static int sumOfOddPlace(String cardNumber)
    
```

- **9.24** (Implement the *StringBuilder* class) The *StringBuilder* class is provided in the Java library. Provide your own implementation for the following methods (name the new class *MyStringBuilder2*):

```

    public MyStringBuilder2();
    public MyStringBuilder2(char[] chars);
    public MyStringBuilder2(String s);
    public MyStringBuilder2 insert(int offset, MyStringBuilder2 s);
    public MyStringBuilder2 reverse();
    public MyStringBuilder2 substring(int begin);
    public MyStringBuilder2 toUpperCase();
    
```

- ***9.25** (Game: *hangman*) Write a hangman game that randomly generates a word and prompts the user to guess one letter at a time, as shown in the sample run. Each letter in the word is displayed as an asterisk. When the user makes a correct guess, the actual letter is then displayed. When the user finishes a word, display the number of misses and ask the user whether to continue to play with another word. Declare an array to store words, as follows:

```

// Add any words you wish in this array
String[] words = {"write", "that", ...};
    
```

```

(Guess) Enter a letter in word ***** > p ↵ Enter
(Guess) Enter a letter in word p***** > r ↵ Enter
(Guess) Enter a letter in word pr***r** > p ↵ Enter
      p is already in the word
(Guess) Enter a letter in word pr***r** > o ↵ Enter
(Guess) Enter a letter in word pro*r** > g ↵ Enter
(Guess) Enter a letter in word progr** > n ↵ Enter
      n is not in the word
(Guess) Enter a letter in word progr** > m ↵ Enter
(Guess) Enter a letter in word progr*m > a ↵ Enter
The word is program. You missed 1 time
Do you want to guess another word? Enter y or n>
    
```



- **9.26** (Check ISBN-10) Use string operations to simplify Programming Exercise 3.9. Enter the first 9 digits of an ISBN number as a string.



VideoNote

Check ISBN-10

- *9.27** (*Bioinformatics: find genes*) Biologists use a sequence of the letters A, C, T, and G to model a *genome*. A *gene* is a substring of a genome that starts after a triplet ATG and ends before a triplet TAG, TAA, or TGA. Furthermore, the length of a gene string is a multiple of 3, and the gene does not contain any of the triplets ATG, TAG, TAA, or TGA. Write a program that prompts the user to enter a genome and displays all genes in the genome. If no gene is found in the input sequence, display “no gene is found”. Here are the sample runs:

```

Enter a genome string: TTATGTTTTAAGGATGGGCGTTAGTT ↵ Enter
TTT
GGGCGT
    
```





```
Enter a genome string: TGTGTGTATAT 
no gene is found
```

***9.28** (*Calculator*) Revise Listing 9.5, `Calculator.java`, to accept an expression in which the operands and operator are separated by zero or more spaces. For example, `3+4` and `3 + 4` are acceptable expressions.

***9.29** (*Business: check ISBN-13*) **ISBN-13** is a new standard for identifying books. It uses the 13 digits $d_1d_2d_3d_4d_5d_6d_7d_8d_9d_{10}d_{11}d_{12}d_{13}$. The last digit, d_{13} , is a checksum, which is calculated from the other digits using the following formula:

$$10 - (d_1 + 3d_2 + d_3 + 3d_4 + d_5 + 3d_6 + d_7 + 3d_8 + d_9 + 3d_{10} + d_{11} + 3d_{12}) \% 10$$

If the checksum is **10**, replace it with **0**. Your program should read the input as a string. Here are sample runs:



```
Enter the first 12 digits of an ISBN-13 as a string:
978013213080 
The ISBN-13 number is 9780132130806
```



```
Enter the first 12 digits of an ISBN-13 as a string:
978013213079 
The ISBN-13 number is 9780132130790
```

***9.30** (*Capitalize first letter of each word*) Write the following method that returns a new string in which the first letter in each word is capitalized.

```
public static void title(String s)
```

Write a test program that prompts the user to enter a string and invokes this method, and displays the return value from this method. Here is a sample run:



```
Enter a string: london england 2015 
The new string is: London England 2015
```

Note that words may be separated by multiple blank spaces.

***9.31** (*Swap case*) Write the following method that returns a new string in which the uppercase letters are changed to lowercase and lowercase letters are changed to uppercase.

```
public static String swapCase(String s)
```

Write a test program that prompts the user to enter a string and invokes this method, and displays the return value from this method. Here is a sample run:



```
Enter a string: I'm here 
The new string is: i'M HERE
```

THINKING IN OBJECTS

Objectives

- To create immutable objects from immutable classes to protect the contents of objects (§10.2).
- To determine the scope of variables in the context of a class (§10.3).
- To use the keyword **this** to refer to the calling object itself (§10.4).
- To apply class abstraction to develop software (§10.5).
- To explore the differences between the procedural paradigm and object-oriented paradigm (§10.6).
- To develop classes for modeling composition relationships (§10.7).
- To design programs using the object-oriented paradigm (§§10.8–10.10).
- To design classes that follow the class-design guidelines (§10.11).
- To create objects for primitive values using the wrapper classes (**Byte**, **Short**, **Integer**, **Long**, **Float**, **Double**, **Character**, and **Boolean**) (§10.12).
- To simplify programming using automatic conversion between primitive types and wrapper class types (§10.13).
- To use the **BigInteger** and **BigDecimal** classes for computing very large numbers with arbitrary precisions (§10.14).



10.1 Introduction



The focus of this chapter is on class design and explores the differences between procedural programming and object-oriented programming.

The preceding two chapters introduced objects and classes. You learned how to define classes, create objects, and use objects from several classes in the Java API (e.g., [Date](#), [Random](#), [String](#), [StringBuilder](#), and [Scanner](#)). This book's approach is to teach problem solving and fundamental programming techniques before object-oriented programming. This chapter shows how procedural and object-oriented programming differ. You will see the benefits of object-oriented programming and learn to use it effectively.

We will use several examples to illustrate the advantages of the object-oriented approach. The examples involve designing new classes and using them in applications. We first introduce some language features supporting these examples.

10.2 Immutable Objects and Classes



You can define immutable classes to create immutable objects. The contents of immutable objects cannot be changed.

Normally, you create an object and allow its contents to be changed later. However, occasionally it is desirable to create an object whose contents cannot be changed once the object has been created. We call such an object an *immutable object* and its class an *immutable class*. The [String](#) class, for example, is immutable. If you deleted the `set` method in the [CircleWithPrivateDataFields](#) class in Listing 8.9, the class would be immutable, because `radius` is private and cannot be changed without a `set` method.

If a class is immutable, then all its data fields must be private and it cannot contain public `set` methods for any data fields. A class with all private data fields and no mutators is not necessarily immutable. For example, the following [Student](#) class has all private data fields and no `set` methods, but it is not an immutable class.

```

1  public class Student {
2      private int id;
3      private String name;
4      private java.util.Date dateCreated;
5
6      public Student(int ssn, String newName) {
7          id = ssn;
8          name = newName;
9          dateCreated = new java.util.Date();
10     }
11
12     public int getId() {
13         return id;
14     }
15
16     public String getName() {
17         return name;
18     }
19
20     public java.util.Date getDateCreated() {
21         return dateCreated;
22     }
23 }
```

As shown in the following code, the data field `dateCreated` is returned using the `getDateCreated()` method. This is a reference to a [Date](#) object. Through this reference, the content for `dateCreated` can be changed.



VideoNote

Immutable objects and this keyword

immutable object

immutable class

Student class

```
public class Test {
    public static void main(String[] args) {
        Student student = new Student(111223333, "John");
        java.util.Date dateCreated = student.getDateCreated();
        dateCreated.setTime(200000); // Now dateCreated field is changed!
    }
}
```

For a class to be immutable, it must meet the following requirements:

- All data fields must be private.
- There can't be any mutator methods for data fields.
- No accessor methods can return a reference to a data field that is mutable.

Interested readers may refer to Supplement III.AB for an extended discussion on immutable objects.

- 10.1** If a class contains only private data fields and no **set** methods, is the class immutable?
- 10.2** If all the data fields in a class are private and primitive types, and the class doesn't contain any **set** methods, is the class immutable?
- 10.3** Is the following class immutable?

```
public class A {
    private int[] values;

    public int[] getValues() {
        return values;
    }
}
```



MyProgrammingLab™

10.3 The Scope of Variables

The scope of instance and static variables is the entire class, regardless of where the variables are declared.



Chapter 5, Methods, discussed local variables and their scope rules. Local variables are declared and used inside a method locally. This section discusses the scope rules of all the variables in the context of a class.

Instance and static variables in a class are referred to as the *class's variables* or *data fields*. A variable defined inside a method is referred to as a *local variable*. The scope of a class's variables is the entire class, regardless of where the variables are declared. A class's variables and methods can appear in any order in the class, as shown in Figure 10.1a. The exception is when a data field is initialized based on a reference to another data field. In such cases, the

class's variables

```
public class Circle {
    public double findArea() {
        return radius * radius * Math.PI;
    }

    private double radius = 1;
}
```

- (a) The variable **radius** and method **findArea()** can be declared in any order.

```
public class F {
    private int i;
    private int j = i + 1;
}
```

- (b) **i** has to be declared before **j** because **j**'s initial value is dependent on **i**.

FIGURE 10.1 Members of a class can be declared in any order, with one exception.

other data field must be declared first, as shown in Figure 10.1b. For consistency, this book declares data fields at the beginning of the class.

You can declare a class's variable only once, but you can declare the same variable name in a method many times in different nonnesting blocks.

If a local variable has the same name as a class's variable, the local variable takes precedence and the class's variable with the same name is *hidden*. For example, in the following program, **x** is defined both as an instance variable and as a local variable in the method.

hidden variables

```
public class F {
    private int x = 0; // Instance variable
    private int y = 0;

    public F() {
    }

    public void p() {
        int x = 1; // Local variable
        System.out.println("x = " + x);
        System.out.println("y = " + y);
    }
}
```

What is the printout for **f.p()**, where **f** is an instance of **F**? The printout for **f.p()** is **1** for **x** and **0** for **y**. Here is why:

- **x** is declared as a data field with the initial value of **0** in the class, but it is also declared in the method **p()** with an initial value of **1**. The latter **x** is referenced in the **System.out.println** statement.
- **y** is declared outside the method **p()**, but **y** is accessible inside the method.



Tip

To avoid confusion and mistakes, do not use the names of instance or static variables as local variable names, except for method parameters.



Check
Point

MyProgrammingLab™

10.4 What is the output of the following program?

```
public class Test {
    private static int i = 0;
    private static int j = 0;

    public static void main(String[] args) {
        int i = 2;
        int k = 3;

        {
            int j = 3;
            System.out.println("i + j is " + i + j);
        }

        k = i + j;
        System.out.println("k is " + k);
        System.out.println("j is " + j);
    }
}
```


10.4 The `this` Reference

The keyword `this` refers to the object itself. It can also be used inside a constructor to invoke another constructor of the same class.



The `this` keyword is the name of a reference that an object can use to refer to itself. You can use the `this` keyword to refer to the object's instance members. For example, the following code in (a) uses `this` to reference the object's `radius` and invokes its `getArea()` method explicitly. The `this` reference is normally omitted, as shown in (b). However, the `this` reference is needed to reference hidden data fields or invoke an overloaded constructor.

this keyword

```
public class Circle {
    private double radius;

    ...

    public double getArea() {
        return this.radius * this.radius
            * Math.PI;
    }

    public String toString() {
        return "radius: " + this.radius
            + "area: " + this.getArea();
    }
}
```

(a)

Equivalent

```
public class Circle {
    private double radius;

    ...

    public double getArea() {
        return radius * radius * Math.PI;
    }

    public String toString() {
        return "radius: " + radius
            + "area: " + getArea();
    }
}
```

(b)

10.4.1 Using `this` to Reference Hidden Data Fields

The `this` keyword can be used to reference a class's *hidden data fields*. For example, a data-field name is often used as the parameter name in a `set` method for the data field. In this case, the data field is hidden in the `set` method. You need to reference the hidden data-field name in the method in order to set a new value to it. A hidden static variable can be accessed simply by using the `ClassName.staticVariable` reference. A hidden instance variable can be accessed by using the keyword `this`, as shown in Figure 10.2a.

hidden data fields

```
public class F {
    private int i = 5;
    private static double k = 0;

    public void setI(int i) {
        this.i = i;
    }

    public static void setK(double k) {
        F.k = k;
    }

    // Other methods omitted
}
```

(a)

Suppose that `f1` and `f2` are two objects of `F`.

Invoking `f1.setI(10)` is to execute
`this.i = 10`, where `this` refers `f1`

Invoking `f2.setI(45)` is to execute
`this.i = 45`, where `this` refers `f2`

Invoking `F.setK(33)` is to execute
`F.k = 33`. `setK` is a static method

(b)

FIGURE 10.2 The keyword `this` refers to the calling object that invokes the method.

The `this` keyword gives us a way to refer to the object that invokes an instance method. To invoke `f1.setI(10)`, `this.i = i` is executed, which assigns the value of parameter `i` to the data field `i` of this calling object `f1`. The keyword `this` refers to the object that invokes

the instance method `setI`, as shown in Figure 10.2b. The line `F.k = k` means that the value in parameter `k` is assigned to the static data field `k` of the class, which is shared by all the objects of the class.

10.4.2 Using `this` to Invoke a Constructor

The `this` keyword can be used to invoke another constructor of the same class. For example, you can rewrite the `Circle` class as follows:

```
public class Circle {
    private double radius;

    public Circle(double radius) {
        this.radius = radius;
    }
    public Circle() {
        this(1.0);
    }
    ...
}
```

The `this` keyword is used to reference the hidden data field `radius` of the object being constructed.

The `this` keyword is used to invoke another constructor.

The line `this(1.0)` in the second constructor invokes the first constructor with a `double` value argument.



Note

Java requires that the `this(arg-list)` statement appear first in the constructor before any other executable statements.



Tip

If a class has multiple constructors, it is better to implement them using `this(arg-list)` as much as possible. In general, a constructor with no or fewer arguments can invoke a constructor with more arguments using `this(arg-list)`. This syntax often simplifies coding and makes the class easier to read and to maintain.



10.5 Describe the role of the `this` keyword.

10.6 What is wrong in the following code?

```
1 public class C {
2     private int p;
3
4     public C() {
5         System.out.println("C's no-arg constructor invoked");
6         this(0);
7     }
8
9     public C(int p) {
10        p = p;
11    }
12
13    public void setP(int p) {
14        p = p;
15    }
16 }
```

10.7 What is wrong in the following code?

```
public class Test {
    private int id;

    public void m1() {
        this.id = 45;
    }

    public void m2() {
        Test.id = 45;
    }
}
```

10.5 Class Abstraction and Encapsulation

Class abstraction is the separation of class implementation from the use of a class. The details of implementation are encapsulated and hidden from the user. This is known as class encapsulation.



In Chapter 5, you learned about method abstraction and used it in stepwise refinement. Java provides many levels of abstraction, and *class abstraction* separates class implementation from how the class is used. The creator of a class describes the functions of the class and lets the user know how the class can be used. The collection of methods and fields that are accessible from outside the class, together with the description of how these members are expected to behave, serves as the *class's contract*. As shown in Figure 10.3, the user of the class does not need to know how the class is implemented. The details of implementation are encapsulated and hidden from the user. This is called *class encapsulation*. For example, you can create a **Circle** object and find the area of the circle without knowing how the area is computed. For this reason, a class is also known as an *abstract data type* (ADT).

class abstraction

class's contract

class encapsulation

abstract data type

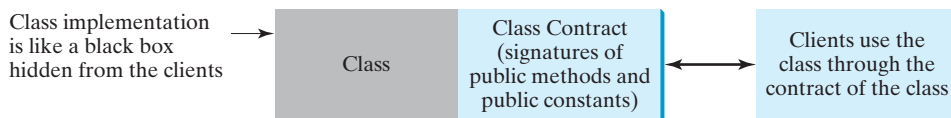


FIGURE 10.3 Class abstraction separates class implementation from the use of the class.

Class abstraction and encapsulation are two sides of the same coin. Many real-life examples illustrate the concept of class abstraction. Consider, for instance, building a computer system. Your personal computer has many components—a CPU, memory, disk, motherboard, fan, and so on. Each component can be viewed as an object that has properties and methods. To get the components to work together, you need know only how each component is used and how it interacts with the others. You don't need to know how the components work internally. The internal implementation is encapsulated and hidden from you. You can build a computer without knowing how a component is implemented.

The computer-system analogy precisely mirrors the object-oriented approach. Each component can be viewed as an object of the class for the component. For example, you might have a class that models all kinds of fans for use in a computer, with properties such as fan size and speed and methods such as start and stop. A specific fan is an instance of this class with specific property values.

As another example, consider getting a loan. A specific loan can be viewed as an object of a **Loan** class. The interest rate, loan amount, and loan period are its data properties, and



VideoNote
The Loan class

computing the monthly payment and total payment are its methods. When you buy a car, a loan object is created by instantiating the class with your loan interest rate, loan amount, and loan period. You can then use the methods to find the monthly payment and total payment of your loan. As a user of the `Loan` class, you don't need to know how these methods are implemented.

Listing 2.8, `ComputeLoan.java`, presented a program for computing loan payments. That program cannot be reused in other programs because the code for computing the payments is in the `main` method. One way to fix this problem is to define static methods for computing the monthly payment and total payment. However, this solution has limitations. Suppose you wish to associate a date with the loan. There is no good way to tie a date with a loan without using objects. The traditional procedural programming paradigm is action-driven, and data are separated from actions. The object-oriented programming paradigm focuses on objects, and actions are defined along with the data in objects. To tie a date with a loan, you can define a loan class with a date along with other of the loan's properties as data fields. A loan object now contains data and actions for manipulating and processing data, and the loan data and actions are integrated in one object. Figure 10.4 shows the UML class diagram for the `Loan` class.

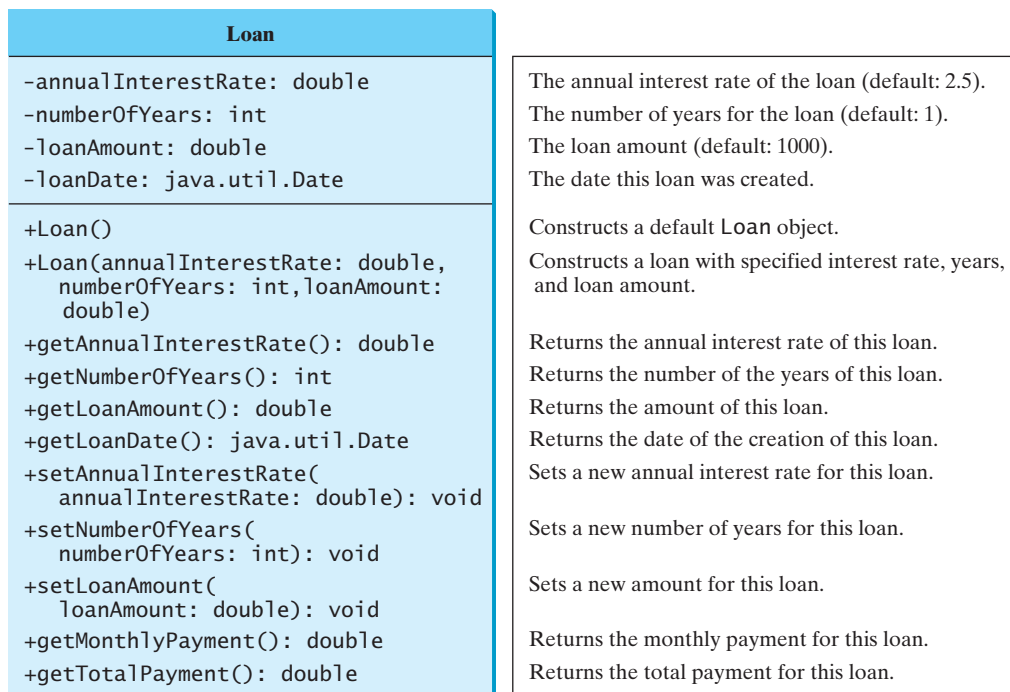


FIGURE 10.4 The `Loan` class models the properties and behaviors of loans.

The UML diagram in Figure 10.4 serves as the contract for the `Loan` class. Throughout this book, you will play the roles of both class user and class developer. Remember that a class user can use the class without knowing how the class is implemented.

Assume that the `Loan` class is available. The program in Listing 10.1 uses that class.

LISTING 10.1 `TestLoanClass.java`

```

1  import java.util.Scanner;
2
3  public class TestLoanClass {
4      /** Main method */
5      public static void main(String[] args) {

```

```

6 // Create a Scanner
7 Scanner input = new Scanner(System.in);
8
9 // Enter annual interest rate
10 System.out.print(
11     "Enter annual interest rate, for example, 8.25: ");
12 double annualInterestRate = input.nextDouble();
13
14 // Enter number of years
15 System.out.print("Enter number of years as an integer: ");
16 int numberOfYears = input.nextInt();
17
18 // Enter loan amount
19 System.out.print("Enter loan amount, for example, 120000.95: ");
20 double loanAmount = input.nextDouble();
21
22 // Create a Loan object
23 Loan loan =
24     new Loan(annualInterestRate, numberOfYears, loanAmount);
25
26 // Display loan date, monthly payment, and total payment
27 System.out.printf("The loan was created on %s\n" +
28     "The monthly payment is %.2f\nThe total payment is %.2f\n",
29     loan.getLoanDate().toString(), loan.getMonthlyPayment(),
30     loan.getTotalPayment());
31 }
32 }

```

create Loan object

invoke instance method
invoke instance method



```

Enter annual interest rate, for example, 8.25: 2.5 ↵ Enter
Enter number of years as an integer: 5 ↵ Enter
Enter loan amount, for example, 120000.95: 1000 ↵ Enter
The loan was created on Sat Jun 16 21:12:50 EDT 2012
The monthly payment is 17.75
The total payment is 1064.84

```

The `main` method reads the interest rate, the payment period (in years), and the loan amount; creates a `Loan` object; and then obtains the monthly payment (line 29) and the total payment (line 30) using the instance methods in the `Loan` class.

The `Loan` class can be implemented as in Listing 10.2.

LISTING 10.2 Loan.java

```

1 public class Loan {
2     private double annualInterestRate;
3     private int numberOfYears;
4     private double loanAmount;
5     private java.util.Date loanDate;
6
7     /** Default constructor */
8     public Loan() {
9         this(2.5, 1, 1000);
10    }
11
12    /** Construct a loan with specified annual interest rate,
13        number of years, and loan amount
14        */

```

no-arg constructor

constructor

```

15  public Loan(double annualInterestRate, int numberOfYears,
16         double loanAmount) {
17      this.annualInterestRate = annualInterestRate;
18      this.numberOfYears = numberOfYears;
19      this.loanAmount = loanAmount;
20      loanDate = new java.util.Date();
21  }
22
23  /** Return annualInterestRate */
24  public double getAnnualInterestRate() {
25      return annualInterestRate;
26  }
27
28  /** Set a new annualInterestRate */
29  public void setAnnualInterestRate(double annualInterestRate) {
30      this.annualInterestRate = annualInterestRate;
31  }
32
33  /** Return numberOfYears */
34  public int getNumberOfYears() {
35      return numberOfYears;
36  }
37
38  /** Set a new numberOfYears */
39  public void setNumberOfYears(int numberOfYears) {
40      this.numberOfYears = numberOfYears;
41  }
42
43  /** Return loanAmount */
44  public double getLoanAmount() {
45      return loanAmount;
46  }
47
48  /** Set a new loanAmount */
49  public void setLoanAmount(double loanAmount) {
50      this.loanAmount = loanAmount;
51  }
52
53  /** Find monthly payment */
54  public double getMonthlyPayment() {
55      double monthlyInterestRate = annualInterestRate / 1200;
56      double monthlyPayment = loanAmount * monthlyInterestRate / (1 -
57          (1 / Math.pow(1 + monthlyInterestRate, numberOfYears * 12)));
58      return monthlyPayment;
59  }
60
61  /** Find total payment */
62  public double getTotalPayment() {
63      double totalPayment = getMonthlyPayment() * numberOfYears * 12;
64      return totalPayment;
65  }
66
67  /** Return loan date */
68  public java.util.Date getLoanDate() {
69      return loanDate;
70  }
71  }

```

From a class developer's perspective, a class is designed for use by many different customers. In order to be useful in a wide range of applications, a class should provide a variety of ways for customization through constructors, properties, and methods.

The `Loan` class contains two constructors, four `get` methods, three `set` methods, and the methods for finding the monthly payment and the total payment. You can construct a `Loan` object by using the no-arg constructor or the constructor with three parameters: annual interest rate, number of years, and loan amount. When a loan object is created, its date is stored in the `LoanDate` field. The `getLoanDate` method returns the date. The three `get` methods—`getAnnualInterest`, `getNumberOfYears`, and `getLoanAmount`—return the annual interest rate, payment years, and loan amount, respectively. All the data properties and methods in this class are tied to a specific instance of the `Loan` class. Therefore, they are instance variables and methods.



Important Pedagogical Tip

Use the UML diagram for the `Loan` class shown in Figure 10.4 to write a test program that uses the `Loan` class even though you don't know how the `Loan` class is implemented. This has three benefits:

- It demonstrates that developing a class and using a class are two separate tasks.
- It enables you to skip the complex implementation of certain classes without interrupting the sequence of this book.
- It is easier to learn how to implement a class if you are familiar with it by using the class.

For all the class examples from now on, create an object from the class and try using its methods before turning your attention to its implementation.

10.8 If you redefine the `Loan` class in Listing 10.2 without `set` methods, is the class immutable?



MyProgrammingLab™

10.6 Object-Oriented Thinking

The procedural paradigm focuses on designing methods. The object-oriented paradigm couples data and methods together into objects. Software design using the object-oriented paradigm focuses on objects and operations on objects.



Chapters 1–7 introduced fundamental programming techniques for problem solving using loops, methods, and arrays. Knowing these techniques lays a solid foundation for object-oriented programming. Classes provide more flexibility and modularity for building reusable software. This section improves the solution for a problem introduced in Chapter 3 using the object-oriented approach. From these improvements, you will gain insight into the differences between procedural and object-oriented programming and see the benefits of developing reusable code using objects and classes.

Listing 3.5, `ComputeAndInterpretBMI.java`, presented a program for computing body mass index. The code cannot be reused in other programs, because the code is in the `main` method. To make it reusable, define a static method to compute body mass index as follows:

```
public static double getBMI(double weight, double height)
```

This method is useful for computing body mass index for a specified weight and height. However, it has limitations. Suppose you need to associate the weight and height with a person's name and birth date. You could declare separate variables to store these values, but these values would not be tightly coupled. The ideal way to couple them is to create an object that contains them all. Since these values are tied to individual objects, they should be stored in instance data fields. You can define a class named `BMI` as shown in Figure 10.5.



VideoNote

The BMI class

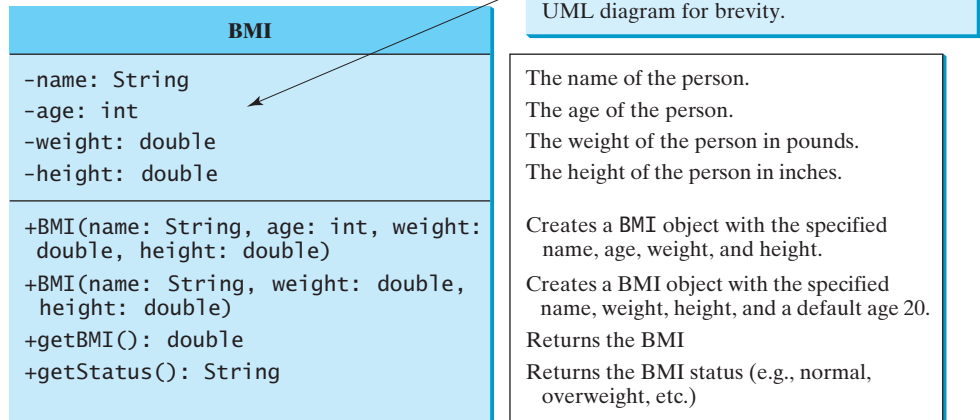


FIGURE 10.5 The **BMI** class encapsulates BMI information.

Assume that the **BMI** class is available. Listing 10.3 gives a test program that uses this class.

LISTING 10.3 UseBMIClass.java

create an object
invoke instance method

create an object
invoke instance method

```

1 public class UseBMIClass {
2     public static void main(String[] args) {
3         BMI bmi1 = new BMI("Kim Yang", 18, 145, 70);
4         System.out.println("The BMI for " + bmi1.getName() + " is "
5             + bmi1.getBMI() + " " + bmi1.getStatus());
6
7         BMI bmi2 = new BMI("Susan King", 215, 70);
8         System.out.println("The BMI for " + bmi2.getName() + " is "
9             + bmi2.getBMI() + " " + bmi2.getStatus());
10    }
11 }

```



```

The BMI for Kim Yang is 20.81 Normal
The BMI for Susan King is 30.85 Obese

```

Line 3 creates the object **bmi1** for **Kim Yang** and line 7 creates the object **bmi2** for **Susan King**. You can use the instance methods **getName()**, **getBMI()**, and **getStatus()** to return the BMI information in a **BMI** object.

The **BMI** class can be implemented as in Listing 10.4.

LISTING 10.4 BMI.java

```

1 public class BMI {
2     private String name;
3     private int age;
4     private double weight; // in pounds
5     private double height; // in inches
6     public static final double KILOGRAMS_PER_POUND = 0.45359237;

```



```

7  public static final double METERS_PER_INCH = 0.0254;
8
9  public BMI(String name, int age, double weight, double height) {      constructor
10     this.name = name;
11     this.age = age;
12     this.weight = weight;
13     this.height = height;
14 }
15
16 public BMI(String name, double weight, double height) {              constructor
17     this(name, 20, weight, height);
18 }
19
20 public double getBMI() {                                             getBMI
21     double bmi = weight * KILOGRAMS_PER_POUND /
22         ((height * METERS_PER_INCH) * (height * METERS_PER_INCH));
23     return Math.round(bmi * 100) / 100.0;
24 }
25
26 public String getStatus() {                                         getStatus
27     double bmi = getBMI();
28     if (bmi < 18.5)
29         return "Underweight";
30     else if (bmi < 25)
31         return "Normal";
32     else if (bmi < 30)
33         return "Overweight";
34     else
35         return "Obese";
36 }
37
38 public String getName() {
39     return name;
40 }
41
42 public int getAge() {
43     return age;
44 }
45
46 public double getWeight() {
47     return weight;
48 }
49
50 public double getHeight() {
51     return height;
52 }
53 }

```

The mathematical formula for computing the BMI using weight and height is given in Section 3.9. The instance method `getBMI()` returns the BMI. Since the weight and height are instance data fields in the object, the `getBMI()` method can use these properties to compute the BMI for the object.

The instance method `getStatus()` returns a string that interprets the BMI. The interpretation is also given in Section 3.9.

This example demonstrates the advantages of the object-oriented paradigm over the procedural paradigm. The procedural paradigm focuses on designing methods. The object-oriented paradigm couples data and methods together into objects. Software design using the object-oriented paradigm focuses on objects and operations on objects. The object-oriented approach

procedural vs. object-oriented
paradigms

combines the power of the procedural paradigm with an added dimension that integrates data with operations into objects.

In procedural programming, data and operations on the data are separate, and this methodology requires sending data to methods. Object-oriented programming places data and the operations that pertain to them in an object. This approach solves many of the problems inherent in procedural programming. The object-oriented programming approach organizes programs in a way that mirrors the real world, in which all objects are associated with both attributes and activities. Using objects improves software reusability and makes programs easier to develop and easier to maintain. Programming in Java involves thinking in terms of objects; a Java program can be viewed as a collection of cooperating objects.



10.9 Is the **BMI** class defined in Listing 10.4 immutable?

MyProgrammingLab™



10.7 Object Composition

An object can contain another object. The relationship between the two is called composition.

In Listing 10.2, you defined the **Loan** class to contain a **Date** data field. The relationship between **Loan** and **Date** is composition. In Listing 10.4, you defined the **BMI** class to contain a **String** data field. The relationship between **BMI** and **String** is composition.

Composition is actually a special case of the aggregation relationship. Aggregation models *has-a* relationships and represents an ownership relationship between two objects. The owner object is called an *aggregating object* and its class an *aggregating class*. The subject object is called an *aggregated object* and its class an *aggregated class*.

An object may be owned by several other aggregating objects. If an object is exclusively owned by an aggregating object, the relationship between them is referred to as *composition*. For example, “a student has a name” is a composition relationship between the **Student** class and the **Name** class, whereas “a student has an address” is an aggregation relationship between the **Student** class and the **Address** class, because an address may be shared by several students. In UML notation, a filled diamond is attached to an aggregating class (e.g., **Student**) to denote the composition relationship with an aggregated class (e.g., **Name**), and an empty diamond is attached to an aggregating class (e.g., **Student**) to denote the aggregation relationship with an aggregated class (e.g., **Address**), as shown in Figure 10.6.

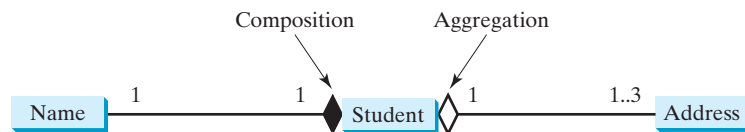


FIGURE 10.6 A student has a name and an address.

aggregation
has-a relationship

composition

multiplicity

Each class involved in a relationship may specify a *multiplicity*. A multiplicity could be a number or an interval that specifies how many of the class’s objects are involved in the relationship. The character ***** means an unlimited number of objects, and the interval **m..n** means that the number of objects should be between **m** and **n**, inclusive. In Figure 10.6, each student has only one address, and each address may be shared by up to **3** students. Each student has one name, and a name is unique for each student.

An aggregation relationship is usually represented as a data field in the aggregating class. For example, the relationship in Figure 10.6 can be represented as follows:

```
public class Name {
    ...
}
```

Aggregated class

```
public class Student {
    private Name name;
    private Address address;
    ...
}
```

Aggregating class

```
public class Address {
    ...
}
```

Aggregated class

Aggregation may exist between objects of the same class. For example, a person may have a supervisor. This is illustrated in Figure 10.7.

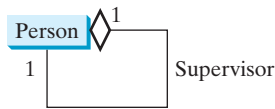
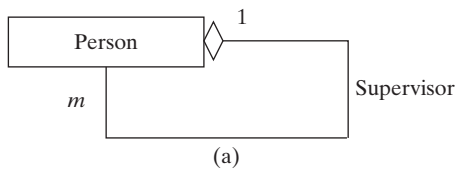


FIGURE 10.7 A person may have a supervisor.

In the relationship “a person has a supervisor,” as shown in Figure 10.7, a supervisor can be represented as a data field in the **Person** class, as follows:

```
public class Person {
    // The type for the data is the class itself
    private Person supervisor;
    ...
}
```

If a person can have several supervisors, as shown in Figure 10.8a, you may use an array to store supervisors, as shown in Figure 10.8b.



(a)

```
public class Person {
    ...
    private Person[] supervisors;
}
```

(b)

FIGURE 10.8 A person can have several supervisors.



Note

Since aggregation and composition relationships are represented using classes in the same way, many texts don't differentiate them and call both compositions. We will do the same in this book for simplicity.

aggregation or composition

10.10 What is an aggregation relationship between two objects?

10.11 What is a composition relationship between two objects?



MyProgrammingLab™

10.8 Case Study: Designing the Course Class



This section designs a class for modeling courses.

This book's philosophy is *teaching by example and learning by doing*. The book provides a wide variety of examples to demonstrate object-oriented programming. This section and the next two offer additional examples on designing classes.

Suppose you need to process course information. Each course has a name and has students enrolled. You should be able to add/drop a student to/from the course. You can use a class to model the courses, as shown in Figure 10.9.

Course	
-courseName: String -students: String[] -numberOfStudents: int	The name of the course. An array to store the students for the course. The number of students (default: 0).
+Course(courseName: String) +getCourseName(): String +addStudent(student: String): void +dropStudent(student: String): void +getStudents(): String[] +getNumberOfStudents(): int	Creates a course with the specified name. Returns the course name. Adds a new student to the course. Drops a student from the course. Returns the students for the course. Returns the number of students for the course.

FIGURE 10.9 The **Course** class models the courses.

A **Course** object can be created using the constructor **Course(String name)** by passing a course name. You can add students to the course using the **addStudent(String student)** method, drop a student from the course using the **dropStudent(String student)** method, and return all the students in the course using the **getStudents()** method. Suppose the class is available; Listing 10.5 gives a test class that creates two courses and adds students to them.

LISTING 10.5 TestCourse.java

```

1  public class TestCourse {
2      public static void main(String[] args) {
3          Course course1 = new Course("Data Structures");
4          Course course2 = new Course("Database Systems");
5
6          course1.addStudent("Peter Jones");
7          course1.addStudent("Kim Smith");
8          course1.addStudent("Anne Kennedy");
9
10         course2.addStudent("Peter Jones");
11        course2.addStudent("Steve Smith");
12
13        System.out.println("Number of students in course1: "
14            + course1.getNumberOfStudents());
15        String[] students = course1.getStudents();
16        for (int i = 0; i < course1.getNumberOfStudents(); i++)
17            System.out.print(students[i] + ", ");
18
19        System.out.println();
20        System.out.print("Number of students in course2: "

```

create a course

add a student

number of students

return students

```

21         + course2.getNumberOfStudents());
22     }
23 }

```

```

Number of students in course1: 3
Peter Jones, Kim Smith, Anne Kennedy,
Number of students in course2: 2

```



The **Course** class is implemented in Listing 10.6. It uses an array to store the students in the course. For simplicity, assume that the maximum course enrollment is **100**. The array is created using **new String[100]** in line 3. The **addStudent** method (line 10) adds a student to the array. Whenever a new student is added to the course, **numberOfStudents** is increased (line 12). The **getStudents** method returns the array. The **dropStudent** method (line 27) is left as an exercise.

LISTING 10.6 Course.java

```

1  public class Course {
2      private String courseName;
3      private String[] students = new String[100];           create students
4      private int numberOfStudents;
5
6      public Course(String courseName) {                     add a course
7          this.courseName = courseName;
8      }
9
10     public void addStudent(String student) {
11         students[numberOfStudents] = student;
12         numberOfStudents++;
13     }
14
15     public String[] getStudents() {                         return students
16         return students;
17     }
18
19     public int getNumberOfStudents() {                       number of students
20         return numberOfStudents;
21     }
22
23     public String getCourseName() {
24         return courseName;
25     }
26
27     public void dropStudent(String student) {
28         // Left as an exercise in Programming Exercise 10.9
29     }
30 }

```

The array size is fixed to be **100** (line 3), so you cannot have more than 100 students in the course. You can improve the class by automatically increasing the array size in Programming Exercise 10.9.

When you create a **Course** object, an array object is created. A **Course** object contains a reference to the array. For simplicity, you can say that the **Course** object contains the array.

The user can create a **Course** object and manipulate it through the public methods **addStudent**, **dropStudent**, **getNumberOfStudents**, and **getStudents**. However, the

user doesn't need to know how these methods are implemented. The **Course** class encapsulates the internal implementation. This example uses an array to store students, but you could use a different data structure to store **students**. The program that uses **Course** does not need to change as long as the contract of the public methods remains unchanged.

10.9 Case Study: Designing a Class for Stacks



This section designs a class for modeling stacks.

Recall that a *stack* is a data structure that holds data in a last-in, first-out fashion, as shown in Figure 10.10.

stack

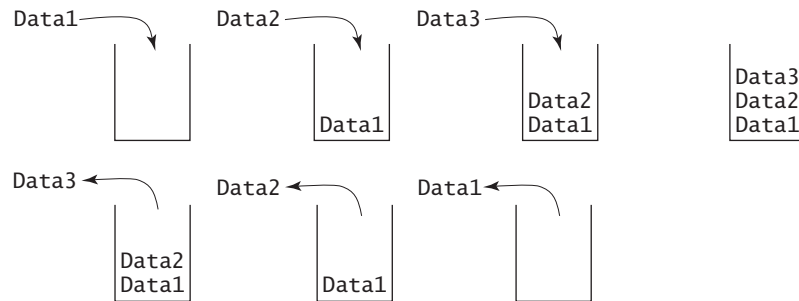


FIGURE 10.10 A stack holds data in a last-in, first-out fashion.

Stacks have many applications. For example, the compiler uses a stack to process method invocations. When a method is invoked, its parameters and local variables are pushed into a stack. When a method calls another method, the new method's parameters and local variables are pushed into the stack. When a method finishes its work and returns to its caller, its associated space is released from the stack.

You can define a class to model stacks. For simplicity, assume the stack holds the **int** values. So name the stack class **StackOfIntegers**. The UML diagram for the class is shown in Figure 10.11.



VideoNote

The StackOfIntegers class

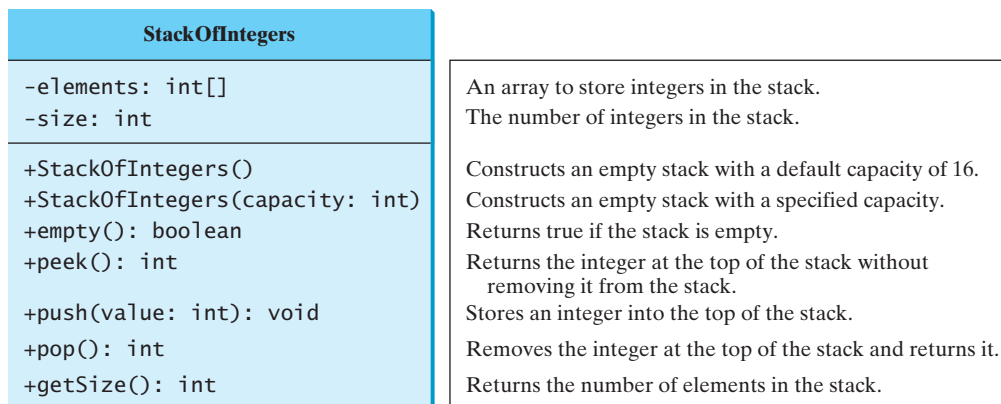


FIGURE 10.11 The **StackOfIntegers** class encapsulates the stack storage and provides the operations for manipulating the stack.

Suppose that the class is available. The test program in Listing 10.7 uses the class to create a stack (line 3), store ten integers **0, 1, 2, . . . , and 9** (line 6), and displays them in reverse order (line 9).

LISTING 10.7 TestStackOfIntegers.java

```

1  public class TestStackOfIntegers {
2      public static void main(String[] args) {
3          StackOfIntegers stack = new StackOfIntegers();           create a stack
4
5          for (int i = 0; i < 10; i++)
6              stack.push(i);                                       push to stack
7
8          while (!stack.empty())
9              System.out.print(stack.pop() + " ");                 pop from stack
10     }
11 }

```

9 8 7 6 5 4 3 2 1 0



How do you implement the `StackOfIntegers` class? The elements in the stack are stored in an array named `elements`. When you create a stack, the array is also created. The no-arg constructor creates an array with the default capacity of `16`. The variable `size` counts the number of elements in the stack, and `size - 1` is the index of the element at the top of the stack, as shown in Figure 10.12. For an empty stack, `size` is `0`.

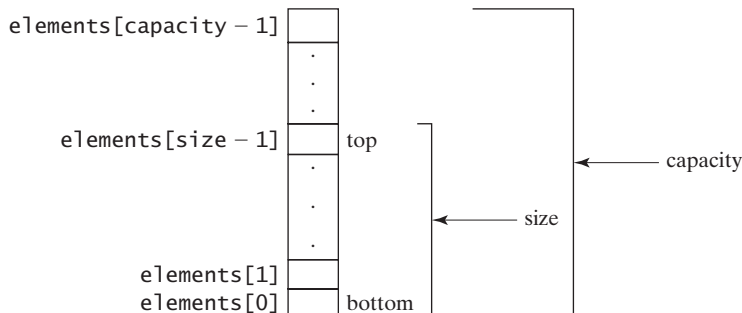


FIGURE 10.12 The `StackOfIntegers` class encapsulates the stack storage and provides the operations for manipulating the stack.

The `StackOfIntegers` class is implemented in Listing 10.8. The methods `empty()`, `peek()`, `pop()`, and `getSize()` are easy to implement. To implement `push(int value)`, assign `value` to `elements[size]` if `size < capacity` (line 24). If the stack is full (i.e., `size >= capacity`), create a new array of twice the current capacity (line 19), copy the contents of the current array to the new array (line 20), and assign the reference of the new array to the current array in the stack (line 21). Now you can add the new value to the array (line 24).

LISTING 10.8 StackOfIntegers.java

```

1  public class StackOfIntegers {
2      private int[] elements;
3      private int size;
4      public static final int DEFAULT_CAPACITY = 16;           max capacity 16
5
6      /** Construct a stack with the default capacity 16 */
7      public StackOfIntegers() {
8          this(DEFAULT_CAPACITY);

```

```

9     }
10
11    /** Construct a stack with the specified maximum capacity */
12    public StackOfIntegers(int capacity) {
13        elements = new int[capacity];
14    }
15
16    /** Push a new integer to the top of the stack */
17    public void push(int value) {
18        if (size >= elements.length) {
19            int[] temp = new int[elements.length * 2];
20            System.arraycopy(elements, 0, temp, 0, elements.length);
21            elements = temp;
22        }
23
24        elements[size++] = value;
25    }
26
27    /** Return and remove the top element from the stack */
28    public int pop() {
29        return elements[--size];
30    }
31
32    /** Return the top element from the stack */
33    public int peek() {
34        return elements[size - 1];
35    }
36
37    /** Test whether the stack is empty */
38    public boolean empty() {
39        return size == 0;
40    }
41
42    /** Return the number of elements in the stack */
43    public int getSize() {
44        return size;
45    }
46 }

```

double the capacity

add to stack

10.10 Case Study: Designing the GuessDate Class



Key
Point

You can define utility classes that contain static methods and static data.

Listing 3.3, `GuessBirthday.java`, and Listing 7.6, `GuessBirthdayUsingArray.java`, presented two programs for guessing birthdays. Both programs use the same data developed with the procedural paradigm. The majority of the code in these two programs is to define the five sets of data. You cannot reuse the code in these two programs, because the code is in the `main` method. To make the code reusable, design a class to encapsulate the data, as defined in Figure 10.13.

Note that `getValue` is defined as a static method because it is not dependent on a specific object of the `GuessDate` class. The `GuessDate` class encapsulates `dates` as a private member. The user of this class doesn't need to know how `dates` is implemented or even that the `dates` field exists in the class. All that the user needs to know is how to use this method to access dates. Suppose this class is available. As shown in Section 3.4, there are five sets of dates. Invoking `getValue(setNo, row, column)` returns the date at the specified row and column in the given set. For example, `getValue(1, 0, 0)` returns 2.

GuessDate	
-dates: int[][][]	The static array to hold dates.
+getValue(setNo: int, row: int, column: int): int	Returns a date at the specified row and column in a given set.

FIGURE 10.13 The **GuessDate** class defines data for guessing birthdays.

Assume that the **GuessDate** class is available. Listing 10.9 is a test program that uses this class.

LISTING 10.9 UseGuessDateClass.java

```

1  import java.util.Scanner;
2
3  public class UseGuessDateClass {
4      public static void main(String[] args) {
5          int date = 0; // Date to be determined
6          int answer;
7
8          // Create a Scanner
9          Scanner input = new Scanner(System.in);
10
11         for (int i = 0; i < 5; i++) {
12             System.out.println("Is your birthday in Set" + (i + 1) + "?");
13             for (int j = 0; j < 4; j++) {
14                 for (int k = 0; k < 4; k++)
15                     System.out.print(GuessDate.getValue(i, j, k) + " ");
16                 System.out.println();
17             }
18
19             System.out.print("\nEnter 0 for No and 1 for Yes: ");
20             answer = input.nextInt();
21
22             if (answer == 1)
23                 date += GuessDate.getValue(i, 0, 0);
24         }
25
26         System.out.println("Your birthday is " + date);
27     }
28 }

```

invoke static method

invoke static method



```

Is your birthday in Set1?
1  3  5  7
9  11 13 15
17 19 21 23
25 27 29 31
Enter 0 for No and 1 for Yes: 0

```

```

Is your birthday in Set2?
2  3  6  7
10 11 14 15
18 19 22 23
26 27 30 31
Enter 0 for No and 1 for Yes: 1

```

```

Is your birthday in Set3?
4  5  6  7
12 13 14 15
20 21 22 23
28 29 30 31
Enter 0 for No and 1 for Yes: 0 ↵ Enter

Is your birthday in Set4?
8  9  10 11
12 13 14 15
24 25 26 27
28 29 30 31
Enter 0 for No and 1 for Yes: 1 ↵ Enter

Is your birthday in Set5?
16 17 18 19
20 21 22 23
24 25 26 27
28 29 30 31
Enter 0 for No and 1 for Yes: 1 ↵ Enter

Your birthday is 26

```

Since `getValue` is a static method, you don't need to create an object in order to invoke it. `GuessDate.getValue(i, j, k)` (line 15) returns the date at row `j` and column `k` in Set `i`. The `GuessDate` class can be implemented as in Listing 10.10.

LISTING 10.10 `GuessDate.java`

```

1 public class GuessDate {
2     private final static int[][][] dates = {
3         {{ 1, 3, 5, 7},
4          { 9, 11, 13, 15},
5          {17, 19, 21, 23},
6          {25, 27, 29, 31}},
7         {{ 2, 3, 6, 7},
8          {10, 11, 14, 15},
9          {18, 19, 22, 23},
10         {26, 27, 30, 31}},
11         {{ 4, 5, 6, 7},
12          {12, 13, 14, 15},
13          {20, 21, 22, 23},
14          {28, 29, 30, 31}},
15         {{ 8, 9, 10, 11},
16          {12, 13, 14, 15},
17          {24, 25, 26, 27},
18          {28, 29, 30, 31}},
19         {{16, 17, 18, 19},
20          {20, 21, 22, 23},
21          {24, 25, 26, 27},
22          {28, 29, 30, 31}}};
23
24     /** Prevent the user from creating objects from GuessDate */
25     private GuessDate() {
26     }
27
28     /** Return a date at the specified row and column in a given set */

```

static field

private constructor

```

29  public static int getValue(int setNo, int i, int j) {
30      return dates[setNo][i][j];
31  }
32  }

```

static method

This class uses a three-dimensional array to store dates (lines 2–22). You could use a different data structure (i.e., five two-dimensional arrays for representing five sets of numbers). The implementation of the `getValue` method would change, but the program that uses `GuessDate` wouldn't need to change as long as the contract of the public method `getValue` remains unchanged. This shows the benefit of data encapsulation.

benefit of data encapsulation

The class defines a private no-arg constructor (line 25) to prevent the user from creating objects for this class. Since all methods are static in this class, there is no need to create objects from this class.

private constructor

10.12 Why is the no-arg constructor in the `Math` class defined private?



MyProgrammingLab™

10.11 Class Design Guidelines

Class design guidelines are helpful for designing sound classes.



You have learned how to design classes from the preceding two examples and from many other examples in the preceding chapters. This section summarizes some of the guidelines.

10.11.1 Cohesion

A class should describe a single entity, and all the class operations should logically fit together to support a coherent purpose. You can use a class for students, for example, but you should not combine students and staff in the same class, because students and staff are different entities.

coherent purpose

A single entity with many responsibilities can be broken into several classes to separate the responsibilities. The classes `String`, `StringBuilder`, and `StringBuffer` all deal with strings, for example, but have different responsibilities. The `String` class deals with immutable strings, the `StringBuilder` class is for creating mutable strings, and the `StringBuffer` class is similar to `StringBuilder` except that `StringBuffer` contains synchronized methods for updating strings.

separating responsibilities

10.11.2 Consistency

Follow standard Java programming style and naming conventions. Choose informative names for classes, data fields, and methods. A popular style is to place the data declaration before the constructor and place constructors before methods.

naming conventions

Make the names consistent. It is not a good practice to choose different names for similar operations. For example, the `length()` method returns the size of a `String`, a `StringBuilder`, and a `StringBuffer`. It would be inconsistent if different names were used for this method in these classes.

naming consistency

In general, you should consistently provide a public no-arg constructor for constructing a default instance. If a class does not support a no-arg constructor, document the reason. If no constructors are defined explicitly, a public default no-arg constructor with an empty body is assumed.

no-arg constructor

If you want to prevent users from creating an object for a class, you can declare a private constructor in the class, as is the case for the `Math` class and the `GuessDate` class.

10.11.3 Encapsulation

A class should use the `private` modifier to hide its data from direct access by clients. This makes the class easy to maintain.

encapsulating data fields

Provide a **get** method only if you want the field to be readable, and provide a **set** method only if you want the field to be updateable. For example, the **Course** class provides a **get** method for **courseName**, but no **set** method, because the user is not allowed to change the course name once it is created.

10.11.4 Clarity

easy to explain

Cohesion, consistency, and encapsulation are good guidelines for achieving design clarity. Additionally, a class should have a clear contract that is easy to explain and easy to understand.

independent methods

Users can incorporate classes in many different combinations, orders, and environments. Therefore, you should design a class that imposes no restrictions on how or when the user can use it, design the properties in a way that lets the user set them in any order and with any combination of values, and design methods that function independently of their order of occurrence. For example, the **Loan** class contains the properties **loanAmount**, **numberOfYears**, and **annualInterestRate**. The values of these properties can be set in any order.

intuitive meaning

Methods should be defined intuitively without causing confusion. For example, the **substring(int beginIndex, int endIndex)** method in the **String** class is somewhat confusing. The method returns a substring from **beginIndex** to **endIndex - 1**, rather than to **endIndex**. It would be more intuitive to return a substring from **beginIndex** to **endIndex**.

independent properties

You should not declare a data field that can be derived from other data fields. For example, the following **Person** class has two data fields: **birthDate** and **age**. Since **age** can be derived from **birthDate**, **age** should not be declared as a data field.

BAD CODE

```
public class Person {
    private java.util.Date birthDate;
    private int age;

    ...
}
```

10.11.5 Completeness

Classes are designed for use by many different customers. In order to be useful in a wide range of applications, a class should provide a variety of ways for customization through properties and methods. For example, the **String** class contains more than 40 methods that are useful for a variety of applications.

10.11.6 Instance vs. Static

A variable or method that is dependent on a specific instance of the class must be an instance variable or method. A variable that is shared by all the instances of a class should be declared static. For example, the variable **numberOfObjects** in **CircleWithPrivateDataFields** in Listing 8.9 is shared by all the objects of the **CircleWithPrivateDataFields** class and therefore is declared static. A method that is not dependent on a specific instance should be defined as a static method. For instance, the **getNumberOfObjects** method in **CircleWithPrivateDataFields** is not tied to any specific instance and therefore is defined as a static method.

Always reference static variables and methods from a class name (rather than a reference variable) to improve readability and avoid errors.

Do not pass a parameter from a constructor to initialize a static data field. It is better to use a **set** method to change the static data field. Thus, the following class in (a) is better replaced by (b).

```
public class Something {
    private int t1;
    private static int t2;

    public Something(int t1, int t2) {
        ...
    }
}
```

(a)

```
public class Something {
    private int t1;
    private static int t2;

    public Something(int t1) {
        ...
    }

    public static void setT2(int t2) {
        Something.t2 = t2;
    }
}
```

(b)

Instance and static are integral parts of object-oriented programming. A data field or method is either instance or static. Do not mistakenly overlook static data fields or methods. It is a common design error to define an instance method that should have been static. For example, the `factorial(int n)` method for computing the factorial of `n` should be defined static, because it is independent of any specific instance.

common design error

A constructor is always instance, because it is used to create a specific instance. A static variable or method can be invoked from an instance method, but an instance variable or method cannot be invoked from a static method.

10.13 Describe class design guidelines.

10.12 Processing Primitive Data Type Values as Objects

A primitive type value is not an object, but it can be wrapped in an object using a wrapper class in the Java API.

Owing to performance considerations, primitive data type values are not objects in Java. Because of the overhead of processing objects, the language's performance would be adversely affected if primitive data type values were treated as objects. However, many Java methods require the use of objects as arguments. Java offers a convenient way to incorporate, or wrap, a primitive data type into an object (e.g., wrapping `int` into the `Integer` class, and wrapping `double` into the `Double` class). Recall that a `char` value can be wrapped into a `Character` object in Section 9.5. By using a wrapper class, you can process primitive data type values as objects. Java provides `Boolean`, `Character`, `Double`, `Float`, `Byte`, `Short`, `Integer`, and `Long` wrapper classes in the `java.lang` package for primitive data types. The `Boolean` class wraps a Boolean value `true` or `false`. This section uses `Integer` and `Double` as examples to introduce the numeric wrapper classes.



MyProgrammingLab™



why wrapper class?



Note

Most wrapper class names for a primitive type are the same as the primitive data type name with the first letter capitalized. The exceptions are `Integer` and `Character`.

naming convention

Numeric wrapper classes are very similar to each other. Each contains the methods `doubleValue()`, `floatValue()`, `intValue()`, `longValue()`, `shortValue()`, and `byteValue()`. These methods “convert” objects into primitive type values. The key features of `Integer` and `Double` are shown in Figure 10.14.

You can construct a wrapper object either from a primitive data type value or from a string representing the numeric value—for example, `new Double(5.0)`, `new Double("5.0")`, `new Integer(5)`, and `new Integer("5")`.

constructors

java.lang.Integer	java.lang.Double
-value: int +MAX_VALUE: int +MIN_VALUE: int	-value: double +MAX_VALUE: double +MIN_VALUE: double
+Integer(value: int) +Integer(s: String) +byteValue(): byte +shortValue(): short +intValue(): int +longVlaue(): long +floatValue(): float +doubleValue(): double +compareTo(o: Integer): int +toString(): String +valueOf(s: String): Integer +valueOf(s: String, radix: int): Integer +parseInt(s: String): int +parseInt(s: String, radix: int): int	+Double(value: double) +Double(s: String) +byteValue(): byte +shortValue(): short +intValue(): int +longVlaue(): long +floatValue(): float +doubleValue(): double +compareTo(o: Double): int +toString(): String +valueOf(s: String): Double +valueOf(s: String, radix: int): Double +parseDouble(s: String): double +parseDouble(s: String, radix: int): double

FIGURE 10.14 The wrapper classes provide constructors, constants, and conversion methods for manipulating various data types.

no no-arg constructor
immutable

The wrapper classes do not have no-arg constructors. The instances of all wrapper classes are immutable; this means that, once the objects are created, their internal values cannot be changed.

constants

Each numeric wrapper class has the constants `MAX_VALUE` and `MIN_VALUE`. `MAX_VALUE` represents the maximum value of the corresponding primitive data type. For `Byte`, `Short`, `Integer`, and `Long`, `MIN_VALUE` represents the minimum `byte`, `short`, `int`, and `long` values. For `Float` and `Double`, `MIN_VALUE` represents the minimum *positive* `float` and `double` values. The following statements display the maximum integer (2,147,483,647), the minimum positive float (1.4E-45), and the maximum double floating-point number (1.79769313486231570e+308d).

```
System.out.println("The maximum integer is " + Integer.MAX_VALUE);
System.out.println("The minimum positive float is " +
    Float.MIN_VALUE);
System.out.println(
    "The maximum double-precision floating-point number is " +
    Double.MAX_VALUE);
```

conversion methods

Each numeric wrapper class contains the methods `doubleValue()`, `floatValue()`, `intValue()`, `longValue()`, and `shortValue()` for returning a `double`, `float`, `int`, `long`, or `short` value for the wrapper object. For example,

```
new Double("12.4").intValue() returns 12;
new Integer("12").doubleValue() returns 12.0;
```

compareTo method

Recall that the `String` class contains the `compareTo` method for comparing two strings. The numeric wrapper classes contain the `compareTo` method for comparing two numbers and returns `1`, `0`, or `-1`, if this number is greater than, equal to, or less than the other number. For example,

```
new Double("12.4").compareTo(new Double("12.3")) returns 1;
new Double("12.3").compareTo(new Double("12.3")) returns 0;
new Double("12.3").compareTo(new Double("12.51")) returns -1;
```

The numeric wrapper classes have a useful static method, `valueOf (String s)`. This static `valueOf` methods method creates a new object initialized to the value represented by the specified string. For example,

```
Double doubleObject = Double.valueOf("12.4");
Integer integerObject = Integer.valueOf("12");
```

You have used the `parseInt` method in the `Integer` class to parse a numeric string into an `int` value and the `parseDouble` method in the `Double` class to parse a numeric string into a `double` value. Each numeric wrapper class has two overloaded parsing methods to parse a numeric string into an appropriate numeric value based on **10** (decimal) or any specified radix (e.g., **2** for binary, **8** for octal, and **16** for hexadecimal). The following examples show how to use these methods. static parsing methods

```
// These two methods are in the Byte class
public static byte parseByte(String s)
public static byte parseByte(String s, int radix)

// These two methods are in the Short class
public static short parseShort(String s)
public static short parseShort(String s, int radix)

// These two methods are in the Integer class
public static int parseInt(String s)
public static int parseInt(String s, int radix)

// These two methods are in the Long class
public static long parseLong(String s)
public static long parseLong(String s, int radix)

// These two methods are in the Float class
public static float parseFloat(String s)
public static float parseFloat(String s, int radix)

// These two methods are in the Double class
public static double parseDouble(String s)
public static double parseDouble(String s, int radix)
```

For example,

```
Integer.parseInt("11", 2) returns 3;
Integer.parseInt("12", 8) returns 10;
Integer.parseInt("13", 10) returns 13;
Integer.parseInt("1A", 16) returns 26;
```

`Integer.parseInt("12", 2)` would raise a runtime exception because **12** is not a binary number.

Note that you can convert a decimal number into a hex number using the `format` method. converting decimal to hex For example,

```
String.format("%x", 26) returns 1A;
```



MyProgrammingLab™

10.14 Describe primitive-type wrapper classes.**10.15** Can each of the following statements be compiled?

- a. `Integer i = new Integer("23");`
- b. `Integer i = new Integer(23);`
- c. `Integer i = Integer.valueOf("23");`
- d. `Integer i = Integer.parseInt("23", 8);`
- e. `Double d = new Double();`
- f. `Double d = Double.valueOf("23.45");`
- g. `int i = (Integer.valueOf("23")).intValue();`
- h. `double d = (Double.valueOf("23.4")).doubleValue();`
- i. `int i = (Double.valueOf("23.4")).intValue();`
- j. `String s = (Double.valueOf("23.4")).toString();`

10.16 How do you convert an integer into a string? How do you convert a numeric string into an integer? How do you convert a double number into a string? How do you convert a numeric string into a double value?**10.17** Show the output of the following code.

```
public class Test {
    public static void main(String[] args) {
        Integer x = new Integer(3);
        System.out.println(x.intValue());
        System.out.println(x.compareTo(new Integer(4)));
    }
}
```

10.18 What is the output of the following code?

```
public class Test {
    public static void main(String[] args) {
        System.out.println(Integer.parseInt("10"));
        System.out.println(Integer.parseInt("10", 10));
        System.out.println(Integer.parseInt("10", 16));
        System.out.println(Integer.parseInt("11"));
        System.out.println(Integer.parseInt("11", 10));
        System.out.println(Integer.parseInt("11", 16));
    }
}
```

10.13 Automatic Conversion between Primitive Types and Wrapper Class Types



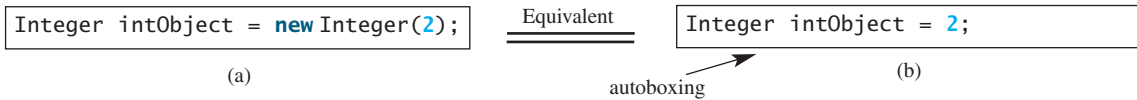
A primitive type value can be automatically converted to an object using a wrapper class, and vice versa, depending on the context.

boxing
unboxing

autoboxing
autounboxing

Converting a primitive value to a wrapper object is called *boxing*. The reverse conversion is called *unboxing*. Java allows primitive types and wrapper classes to be converted automatically. The compiler will automatically box a primitive value that appears in a context requiring an object, and will unbox an object that appears in a context requiring a primitive value. This is called *autoboxing* and *autounboxing*.

For instance, the following statement in (a) can be simplified as in (b) due to autoboxing.



Consider the following example:

```
1 Integer[] intArray = {1, 2, 3};
2 System.out.println(intArray[0] + intArray[1] + intArray[2]);
```

In line 1, the primitive values `1`, `2`, and `3` are automatically boxed into objects `new Integer(1)`, `new Integer(2)`, and `new Integer(3)`. In line 2, the objects `intArray[0]`, `intArray[1]`, and `intArray[2]` are automatically converted into `int` values that are added together.

10.19 What are autoboxing and autounboxing? Are the following statements correct?

- a. `Integer x = 3 + new Integer(5);`
- b. `Integer x = 3;`
- c. `Double x = 3;`
- d. `Double x = 3.0;`
- e. `int x = new Integer(3);`
- f. `int x = new Integer(3) + new Integer(4);`

10.20 Show the output of the following code?

```
public class Test {
    public static void main(String[] args) {
        Double x = new Double(3.5);
        System.out.println(x.intValue());
        System.out.println(x.compareTo(4.5));
    }
}
```



10.14 The `BigInteger` and `BigDecimal` Classes

The `BigInteger` and `BigDecimal` classes can be used to represent integers or decimal numbers of any size and precision.

If you need to compute with very large integers or high-precision floating-point values, you can use the `BigInteger` and `BigDecimal` classes in the `java.math` package. Both are *immutable*. The largest integer of the `long` type is `Long.MAX_VALUE` (i.e., `9223372036854775807`). An instance of `BigInteger` can represent an integer of any size. You can use `new BigInteger(String)` and `new BigDecimal(String)` to create an instance of `BigInteger` and `BigDecimal`, use the `add`, `subtract`, `multiply`, `divide`, and `remainder` methods to perform arithmetic operations, and use the `compareTo` method to compare two big numbers. For example, the following code creates two `BigInteger` objects and multiplies them.

```
BigInteger a = new BigInteger("9223372036854775807");
BigInteger b = new BigInteger("2");
BigInteger c = a.multiply(b); // 9223372036854775807 * 2
System.out.println(c);
```

The output is `18446744073709551614`.



VideoNote
Process large numbers

immutable

There is no limit to the precision of a `BigDecimal` object. The `divide` method may throw an `ArithmeticException` if the result cannot be terminated. However, you can use the overloaded `divide(BigDecimal d, int scale, int roundingMode)` method to specify a scale and a rounding mode to avoid this exception, where `scale` is the maximum number of digits after the decimal point. For example, the following code creates two `BigDecimal` objects and performs division with scale `20` and rounding mode `BigDecimal.ROUND_UP`.

```
BigDecimal a = new BigDecimal(1.0);
BigDecimal b = new BigDecimal(3);
BigDecimal c = a.divide(b, 20, BigDecimal.ROUND_UP);
System.out.println(c);
```

The output is `0.33333333333333333334`.

Note that the factorial of an integer can be very large. Listing 10.11 gives a method that can return the factorial of any integer.

LISTING 10.11 LargeFactorial.java

```
1 import java.math.*;
2
3 public class LargeFactorial {
4     public static void main(String[] args) {
5         System.out.println("50! is \n" + factorial(50));
6     }
7
8     public static BigInteger factorial(long n) {
9         BigInteger result = BigInteger.ONE;
10        for (int i = 1; i <= n; i++)
11            result = result.multiply(new BigInteger(i + ""));
12
13        return result;
14    }
15 }
```

constant

multiply



```
50! is
30414093201713378043612608166064768844377641568960512000000000000
```

`BigInteger.ONE` (line 9) is a constant defined in the `BigInteger` class. `BigInteger.ONE` is the same as `new BigInteger("1")`.

A new result is obtained by invoking the `multiply` method (line 11).



10.21 What is the output of the following code?

```
public class Test {
    public static void main(String[] args) {
        java.math.BigInteger x = new java.math.BigInteger("3");
        java.math.BigInteger y = new java.math.BigInteger("7");
        x.add(y);
        System.out.println(x);
    }
}
```

KEY TERMS

abstract data type (ADT) 375	has-a relationship 382
aggregation 382	immutable class 370
boxing 396	immutable object 370
class abstraction 375	multiplicity 382
class encapsulation 375	stack 386
class's contract 375	<code>this</code> keyword 373
class's variable 371	unboxing 396
composition 382	

CHAPTER SUMMARY

1. Once it is created, an *immutable object* cannot be modified. To prevent users from modifying an object, you can define *immutable classes*.
2. The scope of instance and static variables is the entire class, regardless of where the variables are declared. Instance and static variables can be declared anywhere in the class. For consistency, they are declared at the beginning of the class in this book.
3. The keyword `this` can be used to refer to the calling object. It can also be used inside a constructor to invoke another constructor of the same class.
4. The procedural paradigm focuses on designing methods. The object-oriented paradigm couples data and methods together into objects. Software design using the object-oriented paradigm focuses on objects and operations on objects. The object-oriented approach combines the power of the procedural paradigm with an added dimension that integrates data with operations into objects.
5. Many Java methods require the use of objects as arguments. Java offers a convenient way to incorporate, or wrap, a primitive data type into an object (e.g., wrapping `int` into the `Integer` class, and wrapping `double` into the `Double` class).
6. Java can automatically convert a primitive type value to its corresponding wrapper object in the context and vice versa.
7. The `BigInteger` class is useful for computing and processing integers of any size. The `BigDecimal` class can be used to compute and process floating-point numbers with any arbitrary precision.

TEST QUESTIONS

Do the test questions for this chapter online at www.cs.armstrong.edu/liang/intro9e/test.html.

PROGRAMMING EXERCISES

Sections 10.2–10.6

***10.1** (The `Time` class) Design a class named `Time`. The class contains:

- The data fields `hour`, `minute`, and `second` that represent a time.
- A no-arg constructor that creates a `Time` object for the current time. (The values of the data fields will represent the current time.)

- A constructor that constructs a **Time** object with a specified elapsed time since midnight, January 1, 1970, in milliseconds. (The values of the data fields will represent this time.)
- A constructor that constructs a **Time** object with the specified hour, minute, and second.
- Three **get** methods for the data fields **hour**, **minute**, and **second**, respectively.
- A method named **setTime(long elapsedTime)** that sets a new time for the object using the elapsed time. For example, if the elapsed time is **555550000** milliseconds, the hour is **10**, the minute is **19**, and the second is **10**.

Draw the UML diagram for the class and then implement the class. Write a test program that creates two **Time** objects (using **new Time()** and **new Time(555550000)**) and displays their hour, minute, and second in the format hour:minute:second.

(*Hint:* The first two constructors will extract the hour, minute, and second from the elapsed time. For the no-arg constructor, the current time can be obtained using **System.currentTimeMillis()**, as shown in Listing 2.6, ShowCurrentTime.java.)

10.2 (The **BMI** class) Add the following new constructor in the **BMI** class:

```
/** Construct a BMI with the specified name, age, weight,
 * feet, and inches
 */
public BMI(String name, int age, double weight, double feet,
           double inches)
```

10.3 (The **MyInteger** class) Design a class named **MyInteger**. The class contains:

- An **int** data field named **value** that stores the **int** value represented by this object.
- A constructor that creates a **MyInteger** object for the specified **int** value.
- A **get** method that returns the **int** value.
- The methods **isEven()**, **isOdd()**, and **isPrime()** that return **true** if the value in this object is even, odd, or prime, respectively.
- The static methods **isEven(int)**, **isOdd(int)**, and **isPrime(int)** that return **true** if the specified value is even, odd, or prime, respectively.
- The static methods **isEven(MyInteger)**, **isOdd(MyInteger)**, and **isPrime(MyInteger)** that return **true** if the specified value is even, odd, or prime, respectively.
- The methods **equals(int)** and **equals(MyInteger)** that return **true** if the value in this object is equal to the specified value.
- A static method **parseInt(char[])** that converts an array of numeric characters to an **int** value.
- A static method **parseInt(String)** that converts a string into an **int** value.

Draw the UML diagram for the class and then implement the class. Write a client program that tests all methods in the class.

10.4 (The **MyPoint** class) Design a class named **MyPoint** to represent a point with **x**- and **y**-coordinates. The class contains:

- The data fields **x** and **y** that represent the coordinates with **get** methods.
- A no-arg constructor that creates a point **(0, 0)**.
- A constructor that constructs a point with specified coordinates.
- Two **get** methods for the data fields **x** and **y**, respectively.



VideoNote

The MyPoint class

- A method named **distance** that returns the distance from this point to another point of the **MyPoint** type.
- A method named **distance** that returns the distance from this point to another point with specified **x**- and **y**-coordinates.

Draw the UML diagram for the class and then implement the class. Write a test program that creates the two points **(0, 0)** and **(10, 30.5)** and displays the distance between them.

Sections 10.7–10.11

- *10.5 (*Displaying the prime factors*) Write a program that prompts the user to enter a positive integer and displays all its smallest factors in decreasing order. For example, if the integer is **120**, the smallest factors are displayed as **5, 3, 2, 2, 2**. Use the **StackOfIntegers** class to store the factors (e.g., **2, 2, 2, 3, 5**) and retrieve and display them in reverse order.
- *10.6 (*Displaying the prime numbers*) Write a program that displays all the prime numbers less than **120** in decreasing order. Use the **StackOfIntegers** class to store the prime numbers (e.g., **2, 3, 5, . . .**) and retrieve and display them in reverse order.
- **10.7 (*Game: ATM machine*) Use the **Account** class created in Programming Exercise 8.7 to simulate an ATM machine. Create ten accounts in an array with id **0, 1, . . . , 9**, and initial balance \$100. The system prompts the user to enter an id. If the id is entered incorrectly, ask the user to enter a correct id. Once an id is accepted, the main menu is displayed as shown in the sample run. You can enter a choice **1** for viewing the current balance, **2** for withdrawing money, **3** for depositing money, and **4** for exiting the main menu. Once you exit, the system will prompt for an id again. Thus, once the system starts, it will not stop.

```

Enter an id: 4 

Main menu
1: check balance
2: withdraw
3: deposit
4: exit
Enter a choice: 1 
The balance is 100.0

Main menu
1: check balance
2: withdraw
3: deposit
4: exit
Enter a choice: 2 
Enter an amount to withdraw: 3 

Main menu
1: check balance
2: withdraw
3: deposit
4: exit
Enter a choice: 1 
The balance is 97.0

```



```

Main menu
1: check balance
2: withdraw
3: deposit
4: exit
Enter a choice: 3 ↵ Enter
Enter an amount to deposit: 10 ↵ Enter

Main menu
1: check balance
2: withdraw
3: deposit
4: exit
Enter a choice: 1 ↵ Enter
The balance is 107.0

Main menu
1: check balance
2: withdraw
3: deposit
4: exit
Enter a choice: 4 ↵ Enter

Enter an id:

```

***** 10.8** (*Financial: the **Tax** class*) Programming Exercise 7.12 writes a program for computing taxes using arrays. Design a class named **Tax** to contain the following instance data fields:

- **int filingStatus**: One of the four tax-filing statuses: **0**—single filer, **1**—married filing jointly or qualifying widow(er), **2**—married filing separately, and **3**—head of household. Use the public static constants **SINGLE_FILER (0)**, **MARRIED_JOINTLY_OR_QUALIFYING_WIDOW(ER) (1)**, **MARRIED_SEPARATELY (2)**, **HEAD_OF_HOUSEHOLD (3)** to represent the statuses.
- **int[] [] brackets**: Stores the tax brackets for each filing status.
- **double[] rates**: Stores the tax rates for each bracket.
- **double taxableIncome**: Stores the taxable income.

Provide the **get** and **set** methods for each data field and the **getTax()** method that returns the tax. Also provide a no-arg constructor and the constructor **Tax(filingStatus, brackets, rates, taxableIncome)**.

Draw the UML diagram for the class and then implement the class. Write a test program that uses the **Tax** class to print the 2001 and 2009 tax tables for taxable income from \$50,000 to \$60,000 with intervals of \$1,000 for all four statuses. The tax rates for the year 2009 were given in Table 3.2. The tax rates for 2001 are shown in Table 10.1.

**** 10.9** (*The **Course** class*) Revise the **Course** class as follows:

- The array size is fixed in Listing 10.6. Improve it to automatically increase the array size by creating a new larger array and copying the contents of the current array to it.
- Implement the **dropStudent** method.
- Add a new method named **clear()** that removes all students from the course.

Write a test program that creates a course, adds three students, removes one, and displays the students in the course.

TABLE 10.1 2001 United States Federal Personal Tax Rates

Tax rate	Single filers	Married filing jointly or qualifying widow(er)	Married filing separately	Head of household
15%	Up to \$27,050	Up to \$45,200	Up to \$22,600	Up to \$36,250
27.5%	\$27,051–\$65,550	\$45,201–\$109,250	\$22,601–\$54,625	\$36,251–\$93,650
30.5%	\$65,551–\$136,750	\$109,251–\$166,500	\$54,626–\$83,250	\$93,651–\$151,650
35.5%	\$136,751–\$297,350	\$166,501–\$297,350	\$83,251–\$148,675	\$151,651–\$297,350
39.1%	\$297,351 or more	\$297,351 or more	\$ 148,676 or more	\$297,351 or more

***10.10** (Game: The `GuessDate` class) Modify the `GuessDate` class in Listing 10.10. Instead of representing dates in a three-dimensional array, use five two-dimensional arrays to represent the five sets of numbers. Thus, you need to declare:

```
private static int[][] set1 = {{1, 3, 5, 7}, ... };
private static int[][] set2 = {{2, 3, 6, 7}, ... };
private static int[][] set3 = {{4, 5, 6, 7}, ... };
private static int[][] set4 = {{8, 9, 10, 11}, ... };
private static int[][] set5 = {{16, 17, 18, 19}, ... };
```

***10.11** (Geometry: The `Circle2D` class) Define the `Circle2D` class that contains:

- Two `double` data fields named `x` and `y` that specify the center of the circle with `get` methods.
- A data field `radius` with a `get` method.
- A no-arg constructor that creates a default circle with `(0, 0)` for `(x, y)` and `1` for `radius`.
- A constructor that creates a circle with the specified `x, y`, and `radius`.
- A method `getArea()` that returns the area of the circle.
- A method `getPerimeter()` that returns the perimeter of the circle.
- A method `contains(double x, double y)` that returns `true` if the specified point `(x, y)` is inside this circle (see Figure 10.15a).
- A method `contains(Circle2D circle)` that returns `true` if the specified circle is inside this circle (see Figure 10.15b).
- A method `overlaps(Circle2D circle)` that returns `true` if the specified circle overlaps with this circle (see Figure 10.15c).

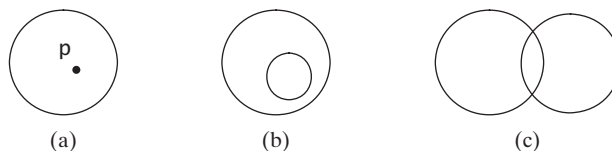


FIGURE 10.15 (a) A point is inside the circle. (b) A circle is inside another circle. (c) A circle overlaps another circle.

Draw the UML diagram for the class and then implement the class. Write a test program that creates a `Circle2D` object `c1` (`new Circle2D(2, 2, 5.5)`), displays its area and perimeter, and displays the result of `c1.contains(3, 3)`, `c1.contains(new Circle2D(4, 5, 10.5))`, and `c1.overlaps(new Circle2D(3, 5, 2.3))`.

*** 10.12 (Geometry: The `Triangle2D` class) Define the `Triangle2D` class that contains:

- Three points named `p1`, `p2`, and `p3` of the type `MyPoint` with `get` and `set` methods. `MyPoint` is defined in Exercise 10.4.
- A no-arg constructor that creates a default triangle with the points $(0, 0)$, $(1, 1)$, and $(2, 5)$.
- A constructor that creates a triangle with the specified points.
- A method `getArea()` that returns the area of the triangle.
- A method `getPerimeter()` that returns the perimeter of the triangle.
- A method `contains(MyPoint p)` that returns `true` if the specified point `p` is inside this triangle (see Figure 10.16a).
- A method `contains(Triangle2D t)` that returns `true` if the specified triangle is inside this triangle (see Figure 10.16b).
- A method `overlaps(Triangle2D t)` that returns `true` if the specified triangle overlaps with this triangle (see Figure 10.16c).

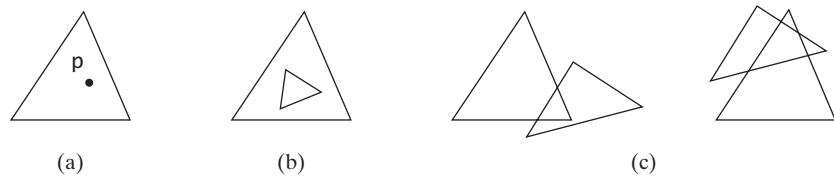


FIGURE 10.16 (a) A point is inside the triangle. (b) A triangle is inside another triangle. (c) A triangle overlaps another triangle.

Draw the UML diagram for the class and then implement the class. Write a test program that creates a `Triangle2D` objects `t1` using the constructor `new Triangle2D(new MyPoint(2.5, 2), new MyPoint(4.2, 3), new MyPoint(5, 3.5))`, displays its area and perimeter, and displays the result of `t1.contains(3, 3)`, `r1.contains(new Triangle2D(new MyPoint(2.9, 2), new MyPoint(4, 1), MyPoint(1, 3.4)))`, and `t1.overlaps(new Triangle2D(new MyPoint(2, 5.5), new MyPoint(4, -3), MyPoint(2, 6.5)))`.

(Hint: For the formula to compute the area of a triangle, see Programming Exercise 2.15. Use the `java.awt.geo.Line2D` class in the Java API to implement the `contains` and `overlaps` methods. The `Line2D` class contains the methods for checking whether two line segments intersect and whether a line contains a point, and so on. Please see the Java API for more information on `Line2D`. To detect whether a point is inside a triangle, draw three dashed lines, as shown in Figure 10.17. If the point is inside a triangle, each dashed line should intersect a side only once. If a dashed line intersects a side twice, then the point must be outside the triangle.)

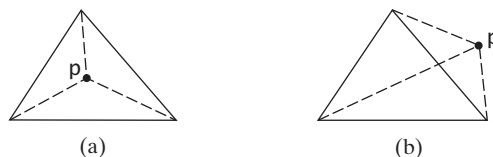


FIGURE 10.17 (a) A point is inside the triangle. (b) A point is outside the triangle.

***10.13** (*Geometry: the `MyRectangle2D` class*) Define the `MyRectangle2D` class that contains:

- Two `double` data fields named `x` and `y` that specify the center of the rectangle with `get` and `set` methods. (Assume that the rectangle sides are parallel to `x`- or `y`- axes.)
- The data fields `width` and `height` with `get` and `set` methods.
- A no-arg constructor that creates a default rectangle with `(0, 0)` for `(x, y)` and `1` for both `width` and `height`.
- A constructor that creates a rectangle with the specified `x`, `y`, `width`, and `height`.
- A method `getArea()` that returns the area of the rectangle.
- A method `getPerimeter()` that returns the perimeter of the rectangle.
- A method `contains(double x, double y)` that returns `true` if the specified point `(x, y)` is inside this rectangle (see Figure 10.18a).
- A method `contains(MyRectangle2D r)` that returns `true` if the specified rectangle is inside this rectangle (see Figure 10.18b).
- A method `overlaps(MyRectangle2D r)` that returns `true` if the specified rectangle overlaps with this rectangle (see Figure 10.18c).

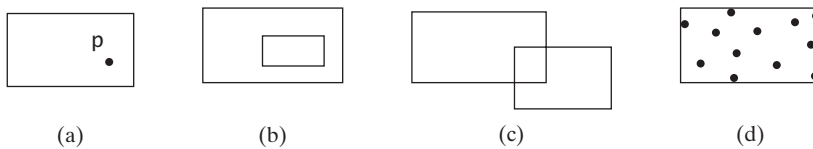


FIGURE 10.18 (a) A point is inside the rectangle. (b) A rectangle is inside another rectangle. (c) A rectangle overlaps another rectangle. (d) Points are enclosed inside a rectangle.

Draw the UML diagram for the class and then implement the class. Write a test program that creates a `MyRectangle2D` object `r1` (`new MyRectangle2D(2, 2, 5.5, 4.9)`), displays its area and perimeter, and displays the result of `r1.contains(3, 3)`, `r1.contains(new MyRectangle2D(4, 5, 10.5, 3.2))`, and `r1.overlaps(new MyRectangle2D(3, 5, 2.3, 5.4))`.

***10.14** (*The `MyDate` class*) Design a class named `MyDate`. The class contains:

- The data fields `year`, `month`, and `day` that represent a date. `month` is 0-based, i.e., `0` is for January.
- A no-arg constructor that creates a `MyDate` object for the current date.
- A constructor that constructs a `MyDate` object with a specified elapsed time since midnight, January 1, 1970, in milliseconds.
- A constructor that constructs a `MyDate` object with the specified year, month, and day.
- Three `get` methods for the data fields `year`, `month`, and `day`, respectively.
- A method named `setDate(long elapsedTime)` that sets a new date for the object using the elapsed time.

Draw the UML diagram for the class and then implement the class. Write a test program that creates two `MyDate` objects (using `new MyDate()` and `new MyDate(34355555133101L)`) and displays their year, month, and day.

(*Hint:* The first two constructors will extract the year, month, and day from the elapsed time. For example, if the elapsed time is `561555550000` milliseconds, the year is

1987, the month is 9, and the day is 18. You may use the `GregorianCalendar` class discussed in Programming Exercise 8.5 to simplify coding.)

- *10.15 (*Geometry: finding the bounding rectangle*) A bounding rectangle is the minimum rectangle that encloses a set of points in a two-dimensional plane, as shown in Figure 10.18d. Write a method that returns a bounding rectangle for a set of points in a two-dimensional plane, as follows:

```
public static MyRectangle2D getRectangle(double[][] points)
```

The `Rectangle2D` class is defined in Exercise 10.13. Write a test program that prompts the user to enter five points and displays the bounding rectangle's center, width, and height. Here is a sample run:



```
Enter five points: 1.0 2.5 3 4 5 6 7 8 9 10 [Enter]
The bounding rectangle's center (5.0, 6.25), width 8.0, height 7.5
```

Sections 10.12–10.14

- *10.16 (*Divisible by 2 or 3*) Find the first ten numbers with 50 decimal digits that are divisible by 2 or 3.
- *10.17 (*Square numbers*) Find the first ten square numbers that are greater than `Long.MAX_VALUE`. A square number is a number in the form of n^2 .
- *10.18 (*Large prime numbers*) Write a program that finds five prime numbers larger than `Long.MAX_VALUE`.
- *10.19 (*Mersenne prime*) A prime number is called a *Mersenne prime* if it can be written in the form $2^p - 1$ for some positive integer p . Write a program that finds all Mersenne primes with $p \leq 100$ and displays the output as shown below. (*Hint*: You have to use `BigInteger` to store the number, because it is too big to be stored in `long`. Your program may take several hours to run.)

p	$2^p - 1$
2	3
3	7
5	31
...	

- *10.20 (*Approximate e*) Programming Exercise 4.26 approximates e using the following series:

$$e = 1 + \frac{1}{1!} + \frac{1}{2!} + \frac{1}{3!} + \frac{1}{4!} + \dots + \frac{1}{i!}$$

In order to get better precision, use `BigDecimal` with 25 digits of precision in the computation. Write a program that displays the e value for $i = 100, 200, \dots$, and 1000.

- 10.21 (*Divisible by 5 or 6*) Find the first ten numbers (greater than `Long.MAX_VALUE`) that are divisible by 5 or 6.

INHERITANCE AND POLYMORPHISM

Objectives

- To define a subclass from a superclass through inheritance (§11.2).
- To invoke the superclass's constructors and methods using the **super** keyword (§11.3).
- To override instance methods in the subclass (§11.4).
- To distinguish differences between overriding and overloading (§11.5).
- To explore the **toString()** method in the **Object** class (§11.6).
- To discover polymorphism and dynamic binding (§§11.7–11.8).
- To describe casting and explain why explicit downcasting is necessary (§11.9).
- To explore the **equals** method in the **Object** class (§11.10).
- To store, retrieve, and manipulate objects in an **ArrayList** (§11.11).
- To implement a **Stack** class using **ArrayList** (§11.12).
- To enable data and methods in a superclass accessible from subclasses using the **protected** visibility modifier (§11.13).
- To prevent class extending and method overriding using the **final** modifier (§11.14).



11.1 Introduction



Object-oriented programming allows you to define new classes from existing classes. This is called inheritance.

inheritance

As discussed earlier in the book, the procedural paradigm focuses on designing methods and the object-oriented paradigm couples data and methods together into objects. Software design using the object-oriented paradigm focuses on objects and operations on objects. The object-oriented approach combines the power of the procedural paradigm with an added dimension that integrates data with operations into objects.

why inheritance?

Inheritance is an important and powerful feature for reusing software. Suppose you need to define classes to model circles, rectangles, and triangles. These classes have many common features. What is the best way to design these classes so as to avoid redundancy and make the system easy to comprehend and easy to maintain? The answer is to use inheritance.

11.2 Superclasses and Subclasses



Inheritance enables you to define a general class (e.g., a superclass) and later extend it to more specialized classes (e.g., subclasses).

You use a class to model objects of the same type. Different classes may have some common properties and behaviors, which can be generalized in a class that can be shared by other classes. You can define a specialized class that extends the generalized class. The specialized classes inherit the properties and methods from the general class.



VideoNote

Geometric class hierarchy

Consider geometric objects. Suppose you want to design the classes to model geometric objects such as circles and rectangles. Geometric objects have many common properties and behaviors. They can be drawn in a certain color and be filled or unfilled. Thus a general class `GeometricObject` can be used to model all geometric objects. This class contains the properties `color` and `filled` and their appropriate `get` and `set` methods. Assume that this class also contains the `dateCreated` property and the `getDateCreated()` and `toString()` methods. The `toString()` method returns a string representation of the object. Since a circle is a special type of geometric object, it shares common properties and methods with other geometric objects. Thus it makes sense to define the `Circle` class that extends the `GeometricObject` class. Likewise, `Rectangle` can also be defined as a subclass of `GeometricObject`. Figure 11.1 shows the relationship among these classes. A triangular arrow pointing to the superclass is used to denote the inheritance relationship between the two classes involved.

subclass

superclass

In Java terminology, a class `C1` extended from another class `C2` is called a *subclass*, and `C2` is called a *superclass*. A superclass is also referred to as a *parent class* or a *base class*, and a subclass as a *child class*, an *extended class*, or a *derived class*. A subclass inherits accessible data fields and methods from its superclass and may also add new data fields and methods.

The `Circle` class inherits all accessible data fields and methods from the `GeometricObject` class. In addition, it has a new data field, `radius`, and its associated `get` and `set` methods. The `Circle` class also contains the `getArea()`, `getPerimeter()`, and `getDiameter()` methods for returning the area, perimeter, and diameter of the circle.

The `Rectangle` class inherits all accessible data fields and methods from the `GeometricObject` class. In addition, it has the data fields `width` and `height` and their associated `get` and `set` methods. It also contains the `getArea()` and `getPerimeter()` methods for returning the area and perimeter of the rectangle.

The `GeometricObject`, `Circle`, and `Rectangle` classes are shown in Listings 11.1, 11.2, and 11.3.



Note

To avoid a naming conflict with the improved `GeometricObject`, `Circle`, and `Rectangle` classes introduced in Chapter 15, we'll name these classes

avoid naming conflicts

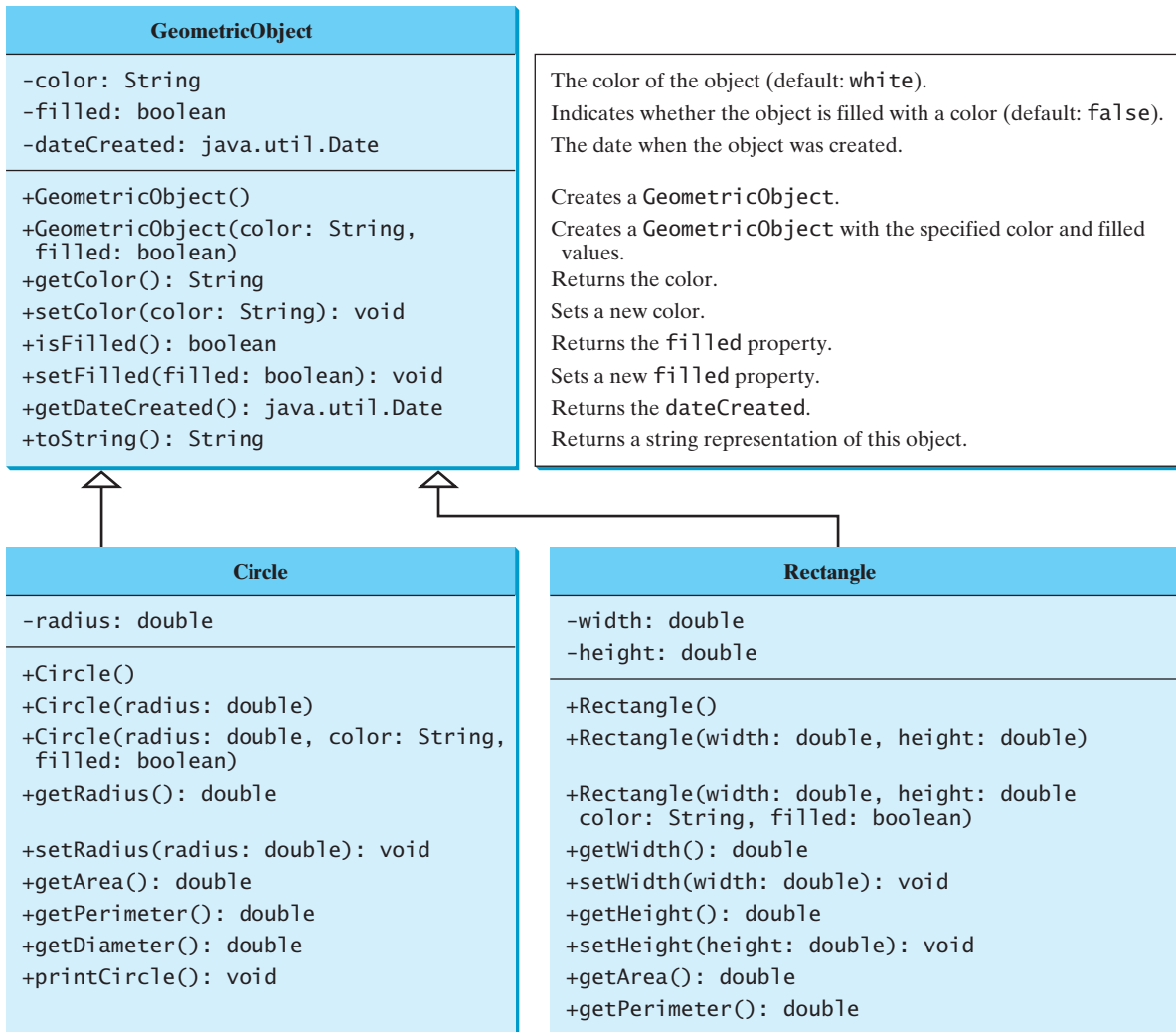


FIGURE 11.1 The `GeometricObject` class is the superclass for `Circle` and `Rectangle`.

`SimpleGeometricObject`, `CircleFromSimpleGeometricObject`, and `RectangleFromSimpleGeometricObject` in this chapter. For simplicity, we will still refer to them in the text as `GeometricObject`, `Circle`, and `Rectangle` classes. The best way to avoid naming conflicts is to place these classes in different packages. However, for simplicity and consistency, all classes in this book are placed in the default package.

LISTING 11.1 `SimpleGeometricObject.java`

```

1 public class SimpleGeometricObject {
2     private String color = "white";           data fields
3     private boolean filled;
4     private java.util.Date dateCreated;
5
6     /** Construct a default geometric object */
7     public SimpleGeometricObject() {         constructor
8         dateCreated = new java.util.Date();  date constructed
  
```

```

9     }
10
11    /** Construct a geometric object with the specified color
12     * and filled value */
13    public SimpleGeometricObject(String color, boolean filled) {
14        dateCreated = new java.util.Date();
15        this.color = color;
16        this.filled = filled;
17    }
18
19    /** Return color */
20    public String getColor() {
21        return color;
22    }
23
24    /** Set a new color */
25    public void setColor(String color) {
26        this.color = color;
27    }
28
29    /** Return filled. Since filled is boolean,
30     * its get method is named isFilled */
31    public boolean isFilled() {
32        return filled;
33    }
34
35    /** Set a new filled */
36    public void setFilled(boolean filled) {
37        this.filled = filled;
38    }
39
40    /** Get dateCreated */
41    public java.util.Date getDateCreated() {
42        return dateCreated;
43    }
44
45    /** Return a string representation of this object */
46    public String toString() {
47        return "created on " + dateCreated + "\ncolor: " + color +
48            " and filled: " + filled;
49    }
50 }

```

LISTING 11.2 CircleFromSimpleGeometricObject.java

```

1  public class CircleFromSimpleGeometricObject
2      extends SimpleGeometricObject {
3      private double radius;
4
5      public CircleFromSimpleGeometricObject() {
6      }
7
8      public CircleFromSimpleGeometricObject(double radius) {
9          this.radius = radius;
10     }
11
12     public CircleFromSimpleGeometricObject(double radius,
13         String color, boolean filled) {
14         this.radius = radius;
15         setColor(color);

```

extends superclass
data fields

constructor

```

16     setFilled(filled);
17 }
18
19 /** Return radius */
20 public double getRadius() {           methods
21     return radius;
22 }
23
24 /** Set a new radius */
25 public void setRadius(double radius) {
26     this.radius = radius;
27 }
28
29 /** Return area */
30 public double getArea() {
31     return radius * radius * Math.PI;
32 }
33
34 /** Return diameter */
35 public double getDiameter() {
36     return 2 * radius;
37 }
38
39 /** Return perimeter */
40 public double getPerimeter() {
41     return 2 * radius * Math.PI;
42 }
43
44 /** Print the circle info */
45 public void printCircle() {
46     System.out.println("The circle is created " + getDateCreated() +
47         " and the radius is " + radius);
48 }
49 }

```

The `Circle` class (Listing 11.2) extends the `GeometricObject` class (Listing 11.1) using the following syntax:

```

Subclass
    |
    v
public class Circle extends GeometricObject
    |
    ^
Superclass

```

The keyword `extends` (lines 1–2) tells the compiler that the `Circle` class extends the `GeometricObject` class, thus inheriting the methods `getColor`, `setColor`, `isFilled`, `setFilled`, and `toString`.

The overloaded constructor `Circle(double radius, String color, boolean filled)` is implemented by invoking the `setColor` and `setFilled` methods to set the `color` and `filled` properties (lines 12–17). These two public methods are defined in the base class `GeometricObject` and are inherited in `Circle`, so they can be used in the derived class.

You might attempt to use the data fields `color` and `filled` directly in the constructor as follows: private member in base class

```

public CircleFromSimpleGeometricObject(
    double radius, String color, boolean filled) {

```

```

    this.radius = radius;
    this.color = color; // Illegal
    this.filled = filled; // Illegal
}

```

This is wrong, because the private data fields `color` and `filled` in the `GeometricObject` class cannot be accessed in any class other than in the `GeometricObject` class itself. The only way to read and modify `color` and `filled` is through their `get` and `set` methods.

The `Rectangle` class (Listing 11.3) extends the `GeometricObject` class (Listing 11.1) using the following syntax:

```

Subclass
    ↓
public class Rectangle extends GeometricObject
    ↑
Superclass

```

The keyword `extends` (lines 1–2) tells the compiler that the `Rectangle` class extends the `GeometricObject` class, thus inheriting the methods `getColor`, `setColor`, `isFilled`, `setFilled`, and `toString`.

LISTING 11.3 RectangleFromSimpleGeometricObject.java

```

1  public class RectangleFromSimpleGeometricObject
2      extends SimpleGeometricObject {
3      private double width;
4      private double height;
5
6      public RectangleFromSimpleGeometricObject() {
7      }
8
9      public RectangleFromSimpleGeometricObject(
10         double width, double height) {
11         this.width = width;
12         this.height = height;
13     }
14
15     public RectangleFromSimpleGeometricObject(
16         double width, double height, String color, boolean filled) {
17         this.width = width;
18         this.height = height;
19         setColor(color);
20         setFilled(filled);
21     }
22
23     /** Return width */
24     public double getWidth() {
25         return width;
26     }
27
28     /** Set a new width */
29     public void setWidth(double width) {
30         this.width = width;
31     }
32

```

extends superclass
data fields

constructor

methods


```

33  /** Return height */
34  public double getHeight() {
35      return height;
36  }
37
38  /** Set a new height */
39  public void setHeight(double height) {
40      this.height = height;
41  }
42
43  /** Return area */
44  public double getArea() {
45      return width * height;
46  }
47
48  /** Return perimeter */
49  public double getPerimeter() {
50      return 2 * (width + height);
51  }
52  }

```

The code in Listing 11.4 creates objects of **Circle** and **Rectangle** and invokes the methods on these objects. The **toString()** method is inherited from the **GeometricObject** class and is invoked from a **Circle** object (line 5) and a **Rectangle** object (line 13).

LISTING 11.4 TestCircleRectangle.java

```

1  public class TestCircleRectangle {
2      public static void main(String[] args) {
3          CircleFromSimpleGeometricObject circle =
4              new CircleFromSimpleGeometricObject(1);
5          System.out.println("A circle " + circle.toString());
6          System.out.println("The color is " + circle.getColor());
7          System.out.println("The radius is " + circle.getRadius());
8          System.out.println("The area is " + circle.getArea());
9          System.out.println("The diameter is " + circle.getDiameter());
10
11         RectangleFromSimpleGeometricObject rectangle =
12             new RectangleFromSimpleGeometricObject(2, 4);
13         System.out.println("\nA rectangle " + rectangle.toString());
14         System.out.println("The area is " + rectangle.getArea());
15         System.out.println("The perimeter is " +
16             rectangle.getPerimeter());
17     }
18 }

```

Circle object
invoke toString
invoke getColor

Rectangle object
invoke toString

```

A circle created on Thu Feb 10 19:54:25 EST 2011
color: white and filled: false
The color is white
The radius is 1.0
The area is 3.141592653589793
The diameter is 2.0
A rectangle created on Thu Feb 10 19:54:25 EST 2011
color: white and filled: false
The area is 8.0
The perimeter is 12.0

```



Note the following points regarding inheritance:

- more in subclass
 - Contrary to the conventional interpretation, a subclass is not a subset of its superclass. In fact, a subclass usually contains more information and methods than its superclass.
- private data fields
 - Private data fields in a superclass are not accessible outside the class. Therefore, they cannot be used directly in a subclass. They can, however, be accessed/mutated through public accessors/mutators if defined in the superclass.
- nonextensible is-a
 - Not all is-a relationships should be modeled using inheritance. For example, a square is a rectangle, but you should not extend a **Square** class from a **Rectangle** class, because the **width** and **height** properties are not appropriate for a square. Instead, you should define a **Square** class to extend the **GeometricObject** class and define the **side** property for the side of a square.
- no blind extension
 - Inheritance is used to model the is-a relationship. Do not blindly extend a class just for the sake of reusing methods. For example, it makes no sense for a **Tree** class to extend a **Person** class, even though they share common properties such as height and weight. A subclass and its superclass must have the is-a relationship.
- multiple inheritance
 - Some programming languages allow you to derive a subclass from several classes. This capability is known as *multiple inheritance*. Java, however, does not allow multiple inheritance. A Java class may inherit directly from only one superclass. This restriction is known as *single inheritance*. If you use the **extends** keyword to define a subclass, it allows only one parent class. Nevertheless, multiple inheritance can be achieved through interfaces, which will be introduced in Section 15.4.
- single inheritance



MyProgrammingLab™

11.1 True or false? A subclass is a subset of a superclass.

11.2 What keyword do you use to define a subclass?

11.3 What is single inheritance? What is multiple inheritance? Does Java support multiple inheritance?

11.3 Using the **super** Keyword



*The keyword **super** refers to the superclass and can be used to invoke the superclass's methods and constructors.*

A subclass inherits accessible data fields and methods from its superclass. Does it inherit constructors? Can the superclass's constructors be invoked from a subclass? This section addresses these questions and their ramifications.

Section 10.4, The **this** Reference, introduced the use of the keyword **this** to reference the calling object. The keyword **super** refers to the superclass of the class in which **super** appears. It can be used in two ways:

- To call a superclass constructor.
- To call a superclass method.

11.3.1 Calling Superclass Constructors

A constructor is used to construct an instance of a class. Unlike properties and methods, the constructors of a superclass are not inherited by a subclass. They can only be invoked from the constructors of the subclasses using the keyword **super**.

The syntax to call a superclass's constructor is:

super(), or **super(parameters)**;

The statement **super()** invokes the no-arg constructor of its superclass, and the statement **super(arguments)** invokes the superclass constructor that matches the **arguments**. The statement **super()** or **super(arguments)** must appear in the first line of the subclass's constructor; this is the only way to explicitly invoke a superclass constructor. For example, the constructor in lines 12–17 in Listing 11.2 can be replaced by the following code:

```
public CircleFromSimpleGeometricObject(
    double radius, String color, boolean filled) {
    super(color, filled);
    this.radius = radius;
}
```

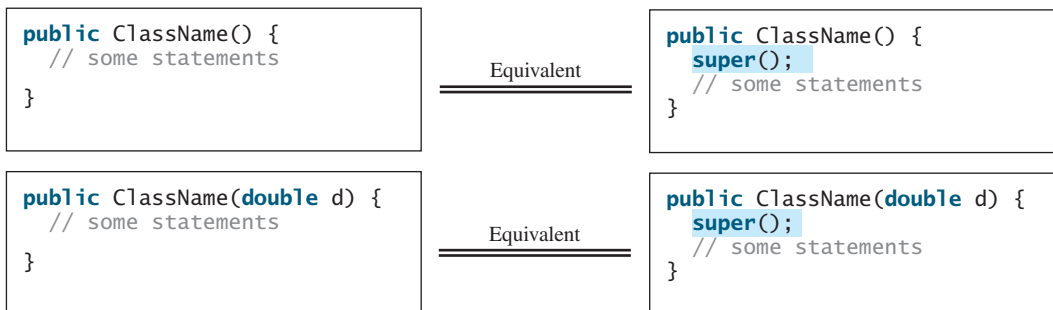


Caution

You must use the keyword **super** to call the superclass constructor, and the call must be the first statement in the constructor. Invoking a superclass constructor's name in a subclass causes a syntax error.

11.3.2 Constructor Chaining

A constructor may invoke an overloaded constructor or its superclass constructor. If neither is invoked explicitly, the compiler automatically puts **super()** as the first statement in the constructor. For example:



In any case, constructing an instance of a class invokes the constructors of all the superclasses along the inheritance chain. When constructing an object of a subclass, the subclass constructor first invokes its superclass constructor before performing its own tasks. If the superclass is derived from another class, the superclass constructor invokes its parent-class constructor before performing its own tasks. This process continues until the last constructor along the inheritance hierarchy is called. This is called *constructor chaining*.

constructor chaining

Consider the following code:

```
1 public class Faculty extends Employee {
2     public static void main(String[] args) {
3         new Faculty();
4     }
5
6     public Faculty() {
```

invoke overloaded
constructor

```

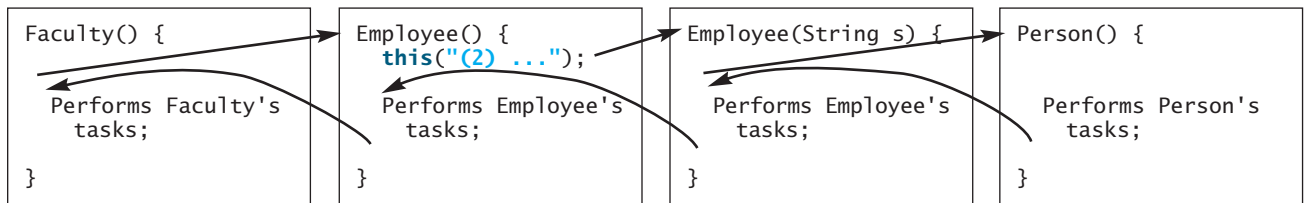
7     System.out.println("(4) Performs Faculty's tasks");
8 }
9 }
10
11 class Employee extends Person {
12     public Employee() {
13         this("(2) Invoke Employee's overloaded constructor");
14         System.out.println("(3) Performs Employee's tasks ");
15     }
16
17     public Employee(String s) {
18         System.out.println(s);
19     }
20 }
21
22 class Person {
23     public Person() {
24         System.out.println("(1) Performs Person's tasks");
25     }
26 }

```



- (1) Performs Person's tasks
- (2) Invoke Employee's overloaded constructor
- (3) Performs Employee's tasks
- (4) Performs Faculty's tasks

The program produces the preceding output. Why? Let us discuss the reason. In line 3, `new Faculty()` invokes `Faculty`'s no-arg constructor. Since `Faculty` is a subclass of `Employee`, `Employee`'s no-arg constructor is invoked before any statements in `Faculty`'s constructor are executed. `Employee`'s no-arg constructor invokes `Employee`'s second constructor (line 12). Since `Employee` is a subclass of `Person`, `Person`'s no-arg constructor is invoked before any statements in `Employee`'s second constructor are executed. This process is illustrated in the following figure.



no-arg constructor



Caution

If a class is designed to be extended, it is better to provide a no-arg constructor to avoid programming errors. Consider the following code:

```

1 public class Apple extends Fruit {
2 }
3
4 class Fruit {
5     public Fruit(String name) {
6         System.out.println("Fruit's constructor is invoked");
7     }
8 }

```

Since no constructor is explicitly defined in **Apple**, **Apple**'s default no-arg constructor is defined implicitly. Since **Apple** is a subclass of **Fruit**, **Apple**'s default constructor automatically invokes **Fruit**'s no-arg constructor. However, **Fruit** does not have a no-arg constructor, because **Fruit** has an explicit constructor defined. Therefore, the program cannot be compiled.



Design Guide

If possible, you should provide a no-arg constructor for every class to make the class easy to extend and to avoid errors.

no-arg constructor

11.3.3 Calling Superclass Methods

The keyword **super** can also be used to reference a method other than the constructor in the superclass. The syntax is:

```
super.method(parameters);
```

You could rewrite the **printCircle()** method in the **Circle** class as follows:

```
public void printCircle() {
    System.out.println("The circle is created " +
        super.getDateCreated() + " and the radius is " + radius);
}
```

It is not necessary to put **super** before **getDateCreated()** in this case, however, because **getDateCreated** is a method in the **GeometricObject** class and is inherited by the **Circle** class. Nevertheless, in some cases, as shown in the next section, the keyword **super** is needed.

11.4 What is the printout of running the class **C** in (a)? What problem arises in compiling the program in (b)?



MyProgrammingLab™

```
class A {
    public A() {
        System.out.println(
            "A's no-arg constructor is invoked");
    }
}

class B extends A {
}

public class C {
    public static void main(String[] args) {
        B b = new B();
    }
}
```

(a)

```
class A {
    public A(int x) {
    }
}

class B extends A {
    public B() {
    }
}

public class C {
    public static void main(String[] args) {
        B b = new B();
    }
}
```

(b)

11.5 How does a subclass invoke its superclass's constructor?

11.6 True or false? When invoking a constructor from a subclass, its superclass's no-arg constructor is always invoked.

11.4 Overriding Methods



To override a method, the method must be defined in the subclass using the same signature and the same return type as in its superclass.

method overriding

A subclass inherits methods from a superclass. Sometimes it is necessary for the subclass to modify the implementation of a method defined in the superclass. This is referred to as *method overriding*.

The `toString` method in the `GeometricObject` class (lines 46–49 in Listing 11.1) returns the string representation of a geometric object. This method can be overridden to return the string representation of a circle. To override it, add the following new method in the `Circle` class in Listing 11.2.

toString in superclass

```

1 public class CircleFromSimpleGeometricObject
2     extends SimpleGeometricObject {
3     // Other methods are omitted
4
5     // Override the toString method defined in the superclass
6     public String toString() {
7         return super.toString() + "\nradius is " + radius;
8     }
9 }
```

The `toString()` method is defined in the `GeometricObject` class and modified in the `Circle` class. Both methods can be used in the `Circle` class. To invoke the `toString` method defined in the `GeometricObject` class from the `Circle` class, use `super.toString()` (line 7).

no super.super.methodName()

Can a subclass of `Circle` access the `toString` method defined in the `GeometricObject` class using syntax such as `super.super.toString()`? No. This is a syntax error.

Several points are worth noting:

override accessible instance method

- An instance method can be overridden only if it is accessible. Thus a private method cannot be overridden, because it is not accessible outside its own class. If a method defined in a subclass is private in its superclass, the two methods are completely unrelated.

cannot override static method

- Like an instance method, a static method can be inherited. However, a static method cannot be overridden. If a static method defined in the superclass is redefined in a subclass, the method defined in the superclass is hidden. The hidden static methods can be invoked using the syntax `SuperClassName.staticMethodName`.



MyProgrammingLab™

11.7 True or false? You can override a private method defined in a superclass.

11.8 True or false? You can override a static method defined in a superclass.

11.9 How do you explicitly invoke a superclass's constructor from a subclass?

11.10 How do you invoke an overridden superclass method from a subclass?

11.5 Overriding vs. Overloading



Overloading means to define multiple methods with the same name but different signatures. Overriding means to provide a new implementation for a method in the subclass.

You learned about overloading methods in Section 5.8. To override a method, the method must be defined in the subclass using the same signature and the same return type.

Let us use an example to show the differences between overriding and overloading. In (a) below, the method `p(double i)` in class `A` overrides the same method defined in class `B`. In (b), however, the class `A` has two overloaded methods: `p(double i)` and `p(int i)`. The method `p(double i)` is inherited from `B`.

```
public class Test {
    public static void main(String[] args) {
        A a = new A();
        a.p(10);
        a.p(10.0);
    }
}

class B {
    public void p(double i) {
        System.out.println(i * 2);
    }
}

class A extends B {
    // This method overrides the method in B
    public void p(double i) {
        System.out.println(i);
    }
}
```

(a)

```
public class Test {
    public static void main(String[] args) {
        A a = new A();
        a.p(10);
        a.p(10.0);
    }
}

class B {
    public void p(double i) {
        System.out.println(i * 2);
    }
}

class A extends B {
    // This method overloads the method in B
    public void p(int i) {
        System.out.println(i);
    }
}
```

(b)

When you run the `Test` class in (a), both `a.p(10)` and `a.p(10.0)` invoke the `p(double i)` method defined in class `A` to display `10.0`. When you run the `Test` class in (b), `a.p(10)` invokes the `p(int i)` method defined in class `A` to display `10`, and `a.p(10.0)` invokes the `p(double i)` method defined in class `B` to display `20.0`.

Note the following:

- Overridden methods are in different classes related by inheritance; overloaded methods can be either in the same class or different classes related by inheritance.
- Overridden methods have the same signature and return type; overloaded methods have the same name but a different parameter list.

To avoid mistakes, you can use a special Java syntax, called *override annotation*, to place `@Override` before the method in the subclass. For example:

override annotation

```
1 public class CircleFromSimpleGeometricObject
2     extends SimpleGeometricObject {
3     // Other methods are omitted
4
5     @Override
6     public String toString() {
7         return super.toString() + "\nradius is " + radius;
8     }
9 }
```

toString in superclass

This annotation denotes that the annotated method is required to override a method in the superclass. If a method with this annotation does not override its superclass's method, the compiler will report an error. For example, if `toString` is mistyped as `tostring`, a compile error is reported. If the override annotation isn't used, the compiler won't report an error. Using annotation avoids mistakes.



MyProgrammingLab™

11.11 Identify the problems in the following code:

```

1  public class Circle {
2      private double radius;
3
4      public Circle(double radius) {
5          radius = radius;
6      }
7
8      public double getRadius() {
9          return radius;
10     }
11
12     public double getArea() {
13         return radius * radius * Math.PI;
14     }
15 }
16
17 class B extends Circle {
18     private double length;
19
20     B(double radius, double length) {
21         Circle(radius);
22         length = length;
23     }
24
25     @Override
26     public double getArea() {
27         return getArea() * length;
28     }
29 }

```

11.12 Explain the difference between method overloading and method overriding.**11.13** If a method in a subclass has the same signature as a method in its superclass with the same return type, is the method overridden or overloaded?**11.14** If a method in a subclass has the same signature as a method in its superclass with a different return type, will this be a problem?**11.15** If a method in a subclass has the same name as a method in its superclass with different parameter types, is the method overridden or overloaded?**11.16** What is the benefit of using the **@Override** annotation?

11.6 The Object Class and Its toString() Method

*Every class in Java is descended from the `java.lang.Object` class.*

If no inheritance is specified when a class is defined, the superclass of the class is **Object** by default. For example, the following two class definitions are the same:

<pre>public class ClassName { ... }</pre>	<p>Equivalent</p> <hr style="border: 1px solid black; width: 100%;"/>	<pre>public class ClassName extends Object { ... }</pre>
---	---	--

Classes such as **String**, **StringBuilder**, **Loan**, and **GeometricObject** are implicitly subclasses of **Object** (as are all the main classes you have seen in this book so far). It is

important to be familiar with the methods provided by the **Object** class so that you can use them in your classes. This section introduces the **toString** method in the **Object** class.

The signature of the **toString()** method is:

toString()

```
public String toString()
```

Invoking **toString()** on an object returns a string that describes the object. By default, it returns a string consisting of a class name of which the object is an instance, an at sign (@), and the object's memory address in hexadecimal. For example, consider the following code for the **Loan** class defined in Listing 10.2:

string representation

```
Loan loan = new Loan();
System.out.println(loan.toString());
```

The output for this code displays something like **Loan@15037e5**. This message is not very helpful or informative. Usually you should override the **toString** method so that it returns a descriptive string representation of the object. For example, the **toString** method in the **Object** class was overridden in the **GeometricObject** class in lines 46–49 in Listing 11.1 as follows:

```
public String toString() {
    return "created on " + dateCreated + "\ncolor: " + color +
        " and filled: " + filled;
}
```



Note

You can also pass an object to invoke **System.out.println(object)** or **System.out.print(object)**. This is equivalent to invoking **System.out.println(object.toString())** or **System.out.print(object.toString())**. Thus, you could replace **System.out.println(loan.toString())** with **System.out.println(loan)**.

print object

11.7 Polymorphism

Polymorphism *means that a variable of a supertype can refer to a subtype object.*

The three pillars of object-oriented programming are encapsulation, inheritance, and polymorphism. You have already learned the first two. This section introduces polymorphism.

First, let us define two useful terms: subtype and supertype. A class defines a type. A type defined by a subclass is called a *subtype*, and a type defined by its superclass is called a *supertype*. Therefore, you can say that **Circle** is a subtype of **GeometricObject** and **GeometricObject** is a supertype for **Circle**.

The inheritance relationship enables a subclass to inherit features from its superclass with additional new features. A subclass is a specialization of its superclass; every instance of a subclass is also an instance of its superclass, but not vice versa. For example, every circle is a geometric object, but not every geometric object is a circle. Therefore, you can always pass an instance of a subclass to a parameter of its superclass type. Consider the code in Listing 11.5.



subtype
supertype

LISTING 11.5 PolymorphismDemo.java

```
1 public class PolymorphismDemo {
2     /** Main method */
3     public static void main(String[] args) {
```

```

4      // Display circle and rectangle properties
5      displayObject(new CircleFromSimpleGeometricObject
6                    (1, "red", false));
7      displayObject(new RectangleFromSimpleGeometricObject
8                    (1, 1, "black", true));
9  }
10
11  /** Display geometric object properties */
12  public static void displayObject(SimpleGeometricObject object) {
13      System.out.println("Created on " + object.getDateCreated() +
14                        ". Color is " + object.getColor());
15  }
16 }

```



```

Created on Mon Mar 09 19:25:20 EDT 2011. Color is white
Created on Mon Mar 09 19:25:20 EDT 2011. Color is black

```

what is polymorphism?

The method `displayObject` (line 12) takes a parameter of the `GeometricObject` type. You can invoke `displayObject` by passing any instance of `GeometricObject` (e.g., `new CircleFromSimpleGeometricObject(1, "red", false)` and `new RectangleFromSimpleGeometricObject(1, 1, "black", false)` in lines 5–8). An object of a subclass can be used wherever its superclass object is used. This is commonly known as *polymorphism* (from a Greek word meaning “many forms”). In simple terms, polymorphism means that a variable of a supertype can refer to a subtype object.

11.8 Dynamic Binding



Key
Point

A method can be implemented in several classes along the inheritance chain. The JVM decides which method is invoked at runtime.

A method can be defined in a superclass and overridden in its subclass. For example, the `toString()` method is defined in the `Object` class and overridden in `GeometricObject`. Consider the following code:

```

Object o = new GeometricObject();
System.out.println(o.toString());

```

declared type

actual type

dynamic binding

Which `toString()` method is invoked by `o`? To answer this question, we first introduce two terms: declared type and actual type. A variable must be declared a type. The type that declares a variable is called the variable’s *declared type*. Here `o`’s declared type is `Object`. A variable of a reference type can hold a `null` value or a reference to an instance of the declared type. The instance may be created using the constructor of the declared type or its subtype. The *actual type* of the variable is the actual class for the object referenced by the variable. Here `o`’s actual type is `GeometricObject`, because `o` references an object created using `new GeometricObject()`. Which `toString()` method is invoked by `o` is determined by `o`’s actual type. This is known as *dynamic binding*.

Dynamic binding works as follows: Suppose an object `o` is an instance of classes `C1`, `C2`, . . . , `Cn-1`, and `Cn`, where `C1` is a subclass of `C2`, `C2` is a subclass of `C3`, . . . , and `Cn-1` is a subclass of `Cn`, as shown in Figure 11.2. That is, `Cn` is the most general class, and `C1` is the most specific class. In Java, `Cn` is the `Object` class. If `o` invokes a method `p`, the JVM searches for the implementation of the method `p` in `C1`, `C2`, . . . , `Cn-1`, and `Cn`, in this order, until it is found. Once an implementation is found, the search stops and the first-found implementation is invoked.

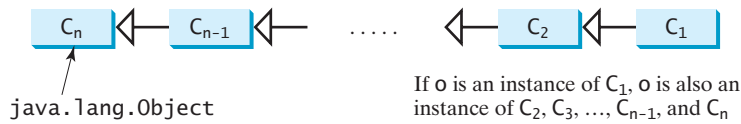


FIGURE 11.2 The method to be invoked is dynamically bound at runtime.

Listing 11.6 gives an example to demonstrate dynamic binding.

LISTING 11.6 DynamicBindingDemo.java

```

1 public class DynamicBindingDemo {
2     public static void main(String[] args) {
3         m(new GraduateStudent());
4         m(new Student());
5         m(new Person());
6         m(new Object());
7     }
8
9     public static void m(Object x) {
10        System.out.println(x.toString());
11    }
12 }
13
14 class GraduateStudent extends Student {
15 }
16
17 class Student extends Person {
18     @Override
19     public String toString() {
20         return "Student";
21     }
22 }
23
24 class Person extends Object {
25     @Override
26     public String toString() {
27         return "Person";
28     }
29 }

```



VideoNote

Polymorphism and dynamic binding demo

polymorphic call

dynamic binding

override toString()

override toString()

```

Student
Student
Person
java.lang.Object@130c19b

```



Method `m` (line 9) takes a parameter of the `Object` type. You can invoke `m` with any object (e.g., `new GraduateStudent()`, `new Student()`, `new Person()`, and `new Object()`) in lines 3–6).

When the method `m(Object x)` is executed, the argument `x`'s `toString` method is invoked. `x` may be an instance of `GraduateStudent`, `Student`, `Person`, or `Object`. The classes `GraduateStudent`, `Student`, `Person`, and `Object` have their own implementations of the `toString` method. Which implementation is used will be determined by `x`'s actual type at runtime. Invoking `m(new GraduateStudent())` (line 3) causes the `toString` method defined in the `Student` class to be invoked.

Invoking `m(new Student())` (line 4) causes the `toString` method defined in the `Student` class to be invoked; invoking `m(new Person())` (line 5) causes the `toString`

matching vs. binding

method defined in the `Person` class to be invoked; and invoking `m(new Object())` (line 6) causes the `toString` method defined in the `Object` class to be invoked.

Matching a method signature and binding a method implementation are two separate issues. The *declared type* of the reference variable decides which method to match at compile time. The compiler finds a matching method according to the parameter type, number of parameters, and order of the parameters at compile time. A method may be implemented in several classes along the inheritance chain. The JVM dynamically binds the implementation of the method at runtime, decided by the actual type of the variable.



MyProgrammingLab™

11.17 What is polymorphism? What is dynamic binding?

11.18 Describe the difference between method matching and method binding.

11.19 Can you assign `new int[50]`, `new Integer[50]`, `new String[50]`, or `new Object[50]`, into a variable of `Object[]` type?

11.20 What is wrong in the following code?

```

1  public class Test {
2      public static void main(String[] args) {
3          Integer[] list1 = {12, 24, 55, 1};
4          Double[] list2 = {12.4, 24.0, 55.2, 1.0};
5          int[] list3 = {1, 2, 3};
6          printArray(list1);
7          printArray(list2);
8          printArray(list3);
9      }
10
11     public static void printArray(Object[] list) {
12         for (Object o: list)
13             System.out.print(o + " ");
14         System.out.println();
15     }
16 }

```

11.21 Show the output of the following code:

```

public class Test {
    public static void main(String[] args) {
        new Person().printPerson();
        new Student().printPerson();
    }
}

class Student extends Person {
    @Override
    public String getInfo() {
        return "Student";
    }
}

class Person {
    public String getInfo() {
        return "Person";
    }

    public void printPerson() {
        System.out.println(getInfo());
    }
}

```

(a)

```

public class Test {
    public static void main(String[] args) {
        new Person().printPerson();
        new Student().printPerson();
    }
}

class Student extends Person {
    private String getInfo() {
        return "Student";
    }
}

class Person {
    private String getInfo() {
        return "Person";
    }

    public void printPerson() {
        System.out.println(getInfo());
    }
}

```

(b)

11.22 Show the output of following program:

```

1  public class Test {
2      public static void main(String[] args) {
3          A a = new A(3);
4      }
5  }
6
7  class A extends B {
8      public A(int t) {
9          System.out.println("A's constructor is invoked");
10     }
11 }
12
13 class B {
14     public B() {
15         System.out.println("B's constructor is invoked");
16     }
17 }

```

Is the no-arg constructor of **Object** invoked when **new A(3)** is invoked?

11.9 Casting Objects and the instanceof Operator

One object reference can be typecast into another object reference. This is called casting object.



In the preceding section, the statement

```
m(new Student());
```

assigns the object **new Student()** to a parameter of the **Object** type. This statement is equivalent to

```
Object o = new Student(); // Implicit casting
m(o);
```

The statement **Object o = new Student()**, known as *implicit casting*, is legal because an instance of **Student** is an instance of **Object**. implicit casting

Suppose you want to assign the object reference **o** to a variable of the **Student** type using the following statement:

```
Student b = o;
```

In this case a compile error would occur. Why does the statement **Object o = new Student()** work but **Student b = o** doesn't? The reason is that a **Student** object is always an instance of **Object**, but an **Object** is not necessarily an instance of **Student**. Even though you can see that **o** is really a **Student** object, the compiler is not clever enough to know it. To tell the compiler that **o** is a **Student** object, use *explicit casting*. The syntax is similar to the one used for casting among primitive data types. Enclose the target object type in parentheses and place it before the object to be cast, as follows: explicit casting

```
Student b = (Student)o; // Explicit casting
```

It is always possible to cast an instance of a subclass to a variable of a superclass (known as *upcasting*), because an instance of a subclass is *always* an instance of its superclass. When casting an instance of a superclass to a variable of its subclass (known as *downcasting*), explicit casting must be used to confirm your intention to the compiler with the upcasting
downcasting

ClassCastException

instanceof

(**SubclassName**) cast notation. For the casting to be successful, you must make sure that the object to be cast is an instance of the subclass. If the superclass object is not an instance of the subclass, a runtime *ClassCastException* occurs. For example, if an object is not an instance of **Student**, it cannot be cast into a variable of **Student**. It is a good practice, therefore, to ensure that the object is an instance of another object before attempting a casting. This can be accomplished by using the *instanceof* operator. Consider the following code:

```
Object myObject = new Circle();
... // Some lines of code
/** Perform casting if myObject is an instance of Circle */
if (myObject instanceof Circle) {
    System.out.println("The circle diameter is " +
        ((Circle)myObject).getDiameter());
    ...
}
```

You may be wondering why casting is necessary. The variable **myObject** is declared **Object**. The *declared type* decides which method to match at compile time. Using **myObject.getDiameter()** would cause a compile error, because the **Object** class does not have the **getDiameter** method. The compiler cannot find a match for **myObject.getDiameter()**. Therefore, it is necessary to cast **myObject** into the **Circle** type to tell the compiler that **myObject** is also an instance of **Circle**.

Why not define **myObject** as a **Circle** type in the first place? To enable generic programming, it is a good practice to define a variable with a supertype, which can accept a value of any subtype.

lowercase keywords

**Note**

instanceof is a Java keyword. Every letter in a Java keyword is in lowercase.

casting analogy

**Tip**

To help understand casting, you may also consider the analogy of fruit, apple, and orange, with the **Fruit** class as the superclass for **Apple** and **Orange**. An apple is a fruit, so you can always safely assign an instance of **Apple** to a variable for **Fruit**. However, a fruit is not necessarily an apple, so you have to use explicit casting to assign an instance of **Fruit** to a variable of **Apple**.

Listing 11.7 demonstrates polymorphism and casting. The program creates two objects (lines 5–6), a circle and a rectangle, and invokes the **displayObject** method to display them (lines 9–10). The **displayObject** method displays the area and diameter if the object is a circle (line 15), and the area if the object is a rectangle (lines 21–22).

LISTING 11.7 CastingDemo.java

```
1 public class CastingDemo {
2     /** Main method */
3     public static void main(String[] args) {
4         // Create and initialize two objects
5         Object object1 = new CircleFromSimpleGeometricObject(1);
6         Object object2 = new RectangleFromSimpleGeometricObject(1, 1);
7
8         // Display circle and rectangle
9         displayObject(object1);
10        displayObject(object2);
11    }
12}
```

```

13  /** A method for displaying an object */
14  public static void displayObject(Object object) {
15      if (object instanceof CircleFromSimpleGeometricObject) {
16          System.out.println("The circle area is " +
17              ((CircleFromSimpleGeometricObject)object).getArea());
18          System.out.println("The circle diameter is " +
19              ((CircleFromSimpleGeometricObject)object).getDiameter());
20      }
21      else if (object instanceof
22              RectangleFromSimpleGeometricObject) {
23          System.out.println("The rectangle area is " +
24              ((RectangleFromSimpleGeometricObject)object).getArea());
25      }
26  }
27  }

```

polymorphic call

polymorphic call

```

The circle area is 3.141592653589793
The circle diameter is 2.0
The rectangle area is 1.0

```



The `displayObject(Object object)` method is an example of generic programming. It can be invoked by passing any instance of `Object`.

The program uses implicit casting to assign a `Circle` object to `object1` and a `Rectangle` object to `object2` (lines 5–6), then invokes the `displayObject` method to display the information on these objects (lines 9–10).

In the `displayObject` method (lines 14–26), explicit casting is used to cast the object to `Circle` if the object is an instance of `Circle`, and the methods `getArea` and `getDiameter` are used to display the area and diameter of the circle.

Casting can be done only when the source object is an instance of the target class. The program uses the `instanceof` operator to ensure that the source object is an instance of the target class before performing a casting (line 15).

Explicit casting to `Circle` (lines 17, 19) and to `Rectangle` (line 24) is necessary because the `getArea` and `getDiameter` methods are not available in the `Object` class.



Caution

The object member access operator (`.`) precedes the casting operator. Use parentheses to ensure that casting is done before the `.` operator, as in

precedes casting

```
((Circle)object).getArea();
```

Casting a primitive type value is different from casting an object reference. Casting a primitive type value returns a new value. For example:

```
int age = 45;
byte newAge = (int)age; // A new value is assigned to newAge
```

However, casting an object reference does not create a new object. For example:

```
Object o = new Circle();
Circle c = (Circle)o; // No new object is created
```

Now reference variables `o` and `c` point to the same object.



11.23 Indicate true or false for the following statements:

- You can always successfully cast an instance of a subclass to a superclass.
- You can always successfully cast an instance of a superclass to a subclass.

11.24 For the **GeometricObject** and **Circle** classes in Listings 11.1 and 11.2, answer the following questions:

a. Are the following Boolean expressions true or false?

```
Circle circle = new Circle(1);
GeometricObject object1 = new GeometricObject();
(circle instanceof GeometricObject)
(object1 instanceof GeometricObject)
(circle instanceof Circle)
(object1 instanceof Circle)
```

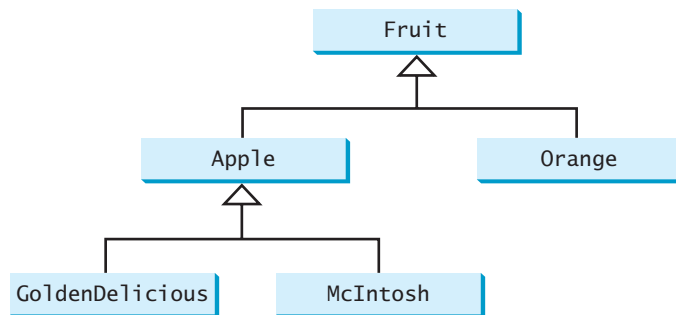
b. Can the following statements be compiled?

```
Circle circle = new Circle(5);
GeometricObject object = circle;
```

c. Can the following statements be compiled?

```
GeometricObject object = new GeometricObject();
Circle circle = (Circle)object;
```

11.25 Suppose that **Fruit**, **Apple**, **Orange**, **GoldenDelicious**, and **McIntosh** are defined in the following inheritance hierarchy:



Assume that the following code is given:

```
Fruit fruit = new GoldenDelicious();
Orange orange = new Orange();
```

Answer the following questions:

- a. Is **fruit instanceof Fruit**?
- b. Is **fruit instanceof Orange**?
- c. Is **fruit instanceof Apple**?
- d. Is **fruit instanceof GoldenDelicious**?
- e. Is **fruit instanceof McIntosh**?
- f. Is **orange instanceof Orange**?

- g. Is `orange instanceof Fruit`?
- h. Is `orange instanceof Apple`?
- i. Suppose the method `makeAppleCider` is defined in the `Apple` class. Can `fruit` invoke this method? Can `orange` invoke this method?
- j. Suppose the method `makeOrangeJuice` is defined in the `Orange` class. Can `orange` invoke this method? Can `fruit` invoke this method?
- k. Is the statement `Orange p = new Apple()` legal?
- l. Is the statement `McIntosh p = new Apple()` legal?
- m. Is the statement `Apple p = new McIntosh()` legal?

11.26 What is wrong in the following code?

```

1 public class Test {
2     public static void main(String[] args) {
3         Object fruit = new Fruit();
4         Object apple = (Apple)fruit;
5     }
6 }
7
8 class Apple extends Fruit {
9 }
10
11 class Fruit {
12 }

```

11.10 The `Object`'s `equals` Method

Like the `toString()` method, the `equals(Object)` method is another method defined in the `Object` class.



Another method defined in the `Object` class that is often used is the `equals` method. Its signature is

`equals(Object)`

```
public boolean equals(Object o)
```

This method tests whether two objects are equal. The syntax for invoking it is:

```
object1.equals(object2);
```

The default implementation of the `equals` method in the `Object` class is:

```
public boolean equals(Object obj) {
    return (this == obj);
}
```

This implementation checks whether two reference variables point to the same object using the `==` operator. You should override this method in your custom class to test whether two distinct objects have the same content.

The `equals` method is overridden in many classes in the Java API, such as `java.lang.String` and `java.util.Date`, to compare whether the contents of two objects are equal. You have already used the `equals` method to compare two strings in Section 9.2, The `String` Class. The `equals` method in the `String` class is inherited from the `Object` class and is overridden in the `String` class to test whether two strings are identical in content.

You can override the `equals` method in the `Circle` class to compare whether two circles are equal based on their radius as follows:

```
public boolean equals(Object o) {
    if (o instanceof Circle) {
        return radius == ((Circle)o).radius;
    }
    else
        return false;
}
```

`==` vs. `equals`



Note

The `==` comparison operator is used for comparing two primitive data type values or for determining whether two objects have the same references. The `equals` method is intended to test whether two objects have the same contents, provided that the method is overridden in the defining class of the objects. The `==` operator is stronger than the `equals` method, in that the `==` operator checks whether the two reference variables refer to the same object.



Caution

Using the signature `equals(SomeClassName obj)` (e.g., `equals(Circle c)`) to override the `equals` method in a subclass is a common mistake. You should use `equals(Object obj)`. See CheckPoint Question 11.28.

`equals(Object)`



11.27 Does every object have a `toString` method and an `equals` method? Where do they come from? How are they used? Is it appropriate to override these methods?

MyProgrammingLab™

11.28 When overriding the `equals` method, a common mistake is mistyping its signature in the subclass. For example, the `equals` method is incorrectly written as `equals(Circle circle)`, as shown in (a) in following the code; instead, it should be `equals(Object circle)`, as shown in (b). Show the output of running class `Test` with the `Circle` class in (a) and in (b), respectively.

```
public class Test {
    public static void main(String[] args) {
        Object circle1 = new Circle();
        Object circle2 = new Circle();
        System.out.println(circle1.equals(circle2));
    }
}
```

```
class Circle {
    double radius;

    public boolean equals(Circle circle) {
        return this.radius == circle.radius;
    }
}
```

(a)

```
class Circle {
    double radius;

    public boolean equals(Object circle) {
        return this.radius ==
            ((Circle)circle).radius;
    }
}
```

(b)

11.11 The ArrayList Class

An `ArrayList` object can be used to store a list of objects.

Now we are ready to introduce a very useful class for storing objects. You can create an array to store objects. But, once the array is created, its size is fixed. Java provides the `ArrayList`



VideoNote

The `ArrayList` class



Key Point

class, which can be used to store an unlimited number of objects. Figure 11.3 shows some methods in `ArrayList`.

<code>java.util.ArrayList<E></code>	
<code>+ArrayList()</code>	Creates an empty list.
<code>+add(o: E): void</code>	Appends a new element <code>o</code> at the end of this list.
<code>+add(index: int, o: E): void</code>	Adds a new element <code>o</code> at the specified index in this list.
<code>+clear(): void</code>	Removes all the elements from this list.
<code>+contains(o: Object): boolean</code>	Returns true if this list contains the element <code>o</code> .
<code>+get(index: int): E</code>	Returns the element from this list at the specified index.
<code>+indexOf(o: Object): int</code>	Returns the index of the first matching element in this list.
<code>+isEmpty(): boolean</code>	Returns true if this list contains no elements.
<code>+lastIndexOf(o: Object): int</code>	Returns the index of the last matching element in this list.
<code>+remove(o: Object): boolean</code>	Removes the element <code>o</code> from this list.
<code>+size(): int</code>	Returns the number of elements in this list.
<code>+remove(index: int): boolean</code>	Removes the element at the specified index.
<code>+set(index: int, o: E): E</code>	Sets the element at the specified index.

FIGURE 11.3 An `ArrayList` stores an unlimited number of objects.

`ArrayList` is known as a generic class with a generic type `E`. You can specify a concrete type to replace `E` when creating an `ArrayList`. For example, the following statement creates an `ArrayList` and assigns its reference to variable `cities`. This `ArrayList` object can be used to store strings.

```
ArrayList<String> cities = new ArrayList<String>();
```

The following statement creates an `ArrayList` and assigns its reference to variable `dates`. This `ArrayList` object can be used to store dates.

```
ArrayList<java.util.Date> dates = new ArrayList<java.util.Date> ();
```



Note

In JDK 7, the statement

```
ArrayList<AConcreteType> list = new ArrayList<AConcreteType> ();
```

can be simplified by

```
ArrayList<AConcreteType> list = new ArrayList<> ();
```

The concrete type is no longer required in the constructor thanks to a feature called *type inference*. The compiler is able to infer the type from the variable declaration. More discussions on generics including how to define custom generic classes and methods will be introduced in Chapter 21, Generics.

type inference

Listing 11.8 gives an example of using `ArrayList` to store objects.

LISTING 11.8 TestArrayList.java

```
1 import java.util.ArrayList;
2
```

```
import ArrayList
```

```

3 public class TestArrayList {
4     public static void main(String[] args) {
5         // Create a list to store cities
6         ArrayList<String> cityList = new ArrayList<String>();
7
8         // Add some cities in the list
9         cityList.add("London");
10        // cityList now contains [London]
11        cityList.add("Denver");
12        // cityList now contains [London, Denver]
13        cityList.add("Paris");
14        // cityList now contains [London, Denver, Paris]
15        cityList.add("Miami");
16        // cityList now contains [London, Denver, Paris, Miami]
17        cityList.add("Seoul");
18        // Contains [London, Denver, Paris, Miami, Seoul]
19        cityList.add("Tokyo");
20        // Contains [London, Denver, Paris, Miami, Seoul, Tokyo]
21
22        System.out.println("List size? " + cityList.size());
23        System.out.println("Is Miami in the list? " +
24            cityList.contains("Miami"));
25        System.out.println("The location of Denver in the list? "
26            + cityList.indexOf("Denver"));
27        System.out.println("Is the list empty? " +
28            cityList.isEmpty()); // Print false
29
30        // Insert a new city at index 2
31        cityList.add(2, "Xian");
32        // Contains [London, Denver, Xian, Paris, Miami, Seoul, Tokyo]
33
34        // Remove a city from the list
35        cityList.remove("Miami");
36        // Contains [London, Denver, Xian, Paris, Seoul, Tokyo]
37
38        // Remove a city at index 1
39        cityList.remove(1);
40        // Contains [London, Xian, Paris, Seoul, Tokyo]
41
42        // Display the contents in the list
43        System.out.println(cityList.toString());
44
45        // Display the contents in the list in reverse order
46        for (int i = cityList.size() - 1; i >= 0; i--)
47            System.out.print(cityList.get(i) + " ");
48        System.out.println();
49
50        // Create a list to store two circles
51        ArrayList<CircleFromSimpleGeometricObject> list
52            = new ArrayList<CircleFromSimpleGeometricObject>();
53
54        // Add two circles
55        list.add(new CircleFromSimpleGeometricObject(2));
56        list.add(new CircleFromSimpleGeometricObject(3));
57
58        // Display the area of the first circle in the list
59        System.out.println("The area of the circle? " +
60            ((CircleFromSimpleGeometricObject)list.get(0)).getArea());
61    }
62 }

```



```
List size? 6
Is Miami in the list? True
The location of Denver in the list? 1
Is the list empty? false
[London, Xian, Paris, Seoul, Tokyo]
Tokyo Seoul Paris Xian London
The area of the circle? 12.566370614359172
```

Since the **ArrayList** is in the **java.util** package, it is imported in line 1. The program creates an **ArrayList** of strings using its no-arg constructor and assigns the reference to **cityList** (line 6). The **add** method (lines 9–19) adds strings to the end of list. So, after **cityList.add("London")** (line 9), the list contains

`add(Object)`

```
[London]
```

After **cityList.add("Denver")** (line 11), the list contains

```
[London, Denver]
```

After adding **Paris**, **Miami**, **Seoul**, and **Tokyo** (lines 13–19), the list contains

```
[London, Denver, Paris, Miami, Seoul, Tokyo]
```

Invoking **size()** (line 22) returns the size of the list, which is currently **6**. Invoking **contains("Miami")** (line 24) checks whether the object is in the list. In this case, it returns **true**, since **Miami** is in the list. Invoking **indexOf("Denver")** (line 26) returns the index of **Denver** in the list, which is **1**. If **Denver** were not in the list, it would return **-1**. The **isEmpty()** method (line 28) checks whether the list is empty. It returns **false**, since the list is not empty.

`size()`

The statement **cityList.add(2, "Xian")** (line 31) inserts an object into the list at the specified index. After this statement, the list becomes

`add(index, Object)`

```
[London, Denver, Xian, Paris, Miami, Seoul, Tokyo]
```

The statement **cityList.remove("Miami")** (line 35) removes the object from the list. After this statement, the list becomes

`remove(Object)`

```
[London, Denver, Xian, Paris, Seoul, Tokyo]
```

The statement **cityList.remove(1)** (line 39) removes the object at the specified index from the list. After this statement, the list becomes

`remove(index)`

```
[London, Xian, Paris, Seoul, Tokyo]
```

The statement in line 43 is same as

```
System.out.println(cityList);
```

The **toString()** method returns a string representation of the list in the form of **[e0.toString(), e1.toString(), ..., ek.toString()]**, where **e0**, **e1**, ..., and **ek** are the elements in the list.

`toString()`

The **get(index)** method (line 47) returns the object at the specified index.

`getIndex()`

ArrayList objects can be used like arrays, but there are many differences. Table 11.1 lists their similarities and differences.

array vs. ArrayList

Once an array is created, its size is fixed. You can access an array element using the square-bracket notation (e.g., **a[index]**). When an **ArrayList** is created, its size is **0**.

TABLE 11.1 Differences and Similarities between Arrays and `ArrayList`

<i>Operation</i>	<i>Array</i>	<i>ArrayList</i>
Creating an array/ArrayList	<code>String[] a = new String[10]</code>	<code>ArrayList<String> list = new ArrayList<>();</code>
Accessing an element	<code>a[index]</code>	<code>list.get(index);</code>
Updating an element	<code>a[index] = "London";</code>	<code>list.set(index, "London");</code>
Returning size	<code>a.length</code>	<code>list.size();</code>
Adding a new element		<code>list.add("London");</code>
Inserting a new element		<code>list.add(index, "London");</code>
Removing an element		<code>list.remove(index);</code>
Removing an element		<code>list.remove(Object);</code>
Removing all elements		<code>list.clear();</code>

You cannot use the `get` and `set` methods if the element is not in the list. It is easy to add, insert, and remove elements in a list, but it is rather complex to add, insert, and remove elements in an array. You have to write code to manipulate the array in order to perform these operations.

Suppose you want to create an `ArrayList` for storing integers. Can you use the following code to create a list?

```
ArrayList<int> list = new ArrayList<int>();
```

No. This will not work because the elements stored in an `ArrayList` must be of an object type. You cannot use a primitive data type such as `int` to replace a generic type. However, you can create an `ArrayList` for storing `Integer` objects as follows:

```
ArrayList<Integer> list = new ArrayList<Integer>();
```

Listing 11.9 gives a program that prompts the user to enter a sequence of numbers and displays the distinct numbers in the sequence. Assume that the input ends with `0` and `0` is not counted as a number in the sequence.

LISTING 11.9 DistinctNumbers.java

```

1  import java.util.ArrayList;
2  import java.util.Scanner;
3
4  public class DistinctNumbers {
5      public static void main(String[] args) {
6          ArrayList<Integer> list = new ArrayList<Integer>();
7
8          Scanner input = new Scanner(System.in);
9          System.out.print("Enter integers (input ends with 0): ");
10         int value;
11
12         do {
13             value = input.nextInt(); // Read a value from the input
14
15             if (!list.contains(value) && value != 0)
16                 list.add(value); // Add the value if it is not in the list
17         } while (value != 0);

```

create an array list

contained in list?
add to list

```

18
19 // Display the distinct numbers
20 for (int i = 0; i < list.size(); i++)
21     System.out.print(list.get(i) + " ");
22 }
23 }

```

Enter numbers (input ends with 0): 1 2 3 2 1 6 3 4 5 4 5 1 2 3 0

The distinct numbers are: 1 2 3 6 4 5



The program creates an **ArrayList** for **Integer** objects (line 6) and repeatedly reads a value in the loop (lines 12–17). For each value, if it is not in the list (line 15), add it to the list (line 16). You can rewrite this program using an array to store the elements rather than using an **ArrayList**. However, it is simpler to implement this program using an **ArrayList** for two reasons.

- First, the size of an **ArrayList** is flexible so you don't have to specify its size in advance. When creating an array, its size must be specified.
- Second, **ArrayList** contains many useful methods. For example, you can test whether an element is in the list using the **contains** method. If you use an array, you have to write additional code to implement this method.

11.29 How do you do the following?

- a. Create an **ArrayList** for storing double values?
- b. Append an object to a list?
- c. Insert an object at the beginning of a list?
- d. Find the number of objects in a list?
- e. Remove a given object from a list?
- f. Remove the last object from the list?
- g. Check whether a given object is in a list?
- h. Retrieve an object at a specified index from a list?



MyProgrammingLab™

11.30 Identify the errors in the following code.

```

ArrayList<String> list = new ArrayList<String> ();
list.add("Denver");
list.add("Austin");
list.add(new java.util.Date());
String city = list.get(0);
list.set(3, "Dallas");
System.out.println(list.get(3));

```

11.31 Suppose the **ArrayList** **list** contains duplicate elements. Does the following code correctly remove the element from the array list? If not, correct the code.

```

for (int i = 0; i < list.size(); i++)
    list.remove(element);

```

11.32 Explain why the following code displays **[1, 3]** rather than **[2, 3]**.

```

ArrayList<Integer> list = new ArrayList<Integer>();
list.add(1);

```

```
list.add(2);
list.add(3);
list.remove(1);
System.out.println(list);
```

11.12 Case Study: A Custom Stack Class



This section designs a stack class for holding objects.



VideoNote

The MyStack class

Section 10.9 presented a stack class for storing **int** values. This section introduces a stack class to store objects. You can use an **ArrayList** to implement **Stack**, as shown in Listing 11.10. The UML diagram for the class is shown in Figure 11.4.

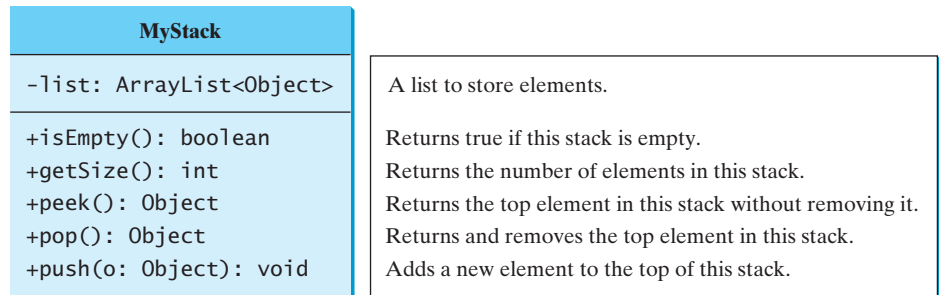


FIGURE 11.4 The **MyStack** class encapsulates the stack storage and provides the operations for manipulating the stack.

LISTING 11.10 MyStack.java

```

1  import java.util.ArrayList;
2
array list      3  public class MyStack {
4      private ArrayList<Object> list = new ArrayList<Object>();
5
stack empty?   6      public boolean isEmpty() {
7          return list.isEmpty();
8      }
9
get stack size 10     public int getSize() {
11         return list.size();
12     }
13
peek stack     14     public Object peek() {
15         return list.get(getSize() - 1);
16     }
17
remove        18     public Object pop() {
19         Object o = list.get(getSize() - 1);
20         list.remove(getSize() - 1);
21         return o;
22     }
23
push          24     public void push(Object o) {
25         list.add(o);
26     }
27
```



```

28  @Override
29  public String toString() {
30      return "stack: " + list.toString();
31  }
32  }

```

An array list is created to store the elements in the stack (line 4). The `isEmpty()` method (lines 6–8) returns `list.isEmpty()`. The `getSize()` method (lines 10–12) returns `list.size()`. The `peek()` method (lines 14–16) retrieves the element at the top of the stack without removing it. The end of the list is the top of the stack. The `pop()` method (lines 18–22) removes the top element from the stack and returns it. The `push(Object element)` method (lines 24–26) adds the specified element to the stack. The `toString()` method (lines 28–31) defined in the `Object` class is overridden to display the contents of the stack by invoking `list.toString()`. The `toString()` method implemented in `ArrayList` returns a string representation of all the elements in an array list.



Design Guide

In Listing 11.10, `MyStack` contains `ArrayList`. The relationship between `MyStack` and `ArrayList` is *composition*. While inheritance models an *is-a* relationship, composition models a *has-a* relationship. You could also implement `MyStack` as a subclass of `ArrayList` (see Programming Exercise 11.4). Using composition is better, however, because it enables you to define a completely new stack class without inheriting the unnecessary and inappropriate methods from `ArrayList`.

composition
is-a
has-a

11.13 The **protected** Data and Methods

A protected member of a class can be accessed from a subclass.

So far you have used the `private` and `public` keywords to specify whether data fields and methods can be accessed from outside of the class. Private members can be accessed only from inside of the class, and public members can be accessed from any other classes.

Often it is desirable to allow subclasses to access data fields or methods defined in the superclass, but not to allow nonsubclasses to access these data fields and methods. To accomplish this, you can use the `protected` keyword. This way you can access protected data fields or methods in a superclass from its subclasses.

The modifiers `private`, `protected`, and `public` are known as *visibility* or *accessibility modifiers* because they specify how classes and class members are accessed. The visibility of these modifiers increases in this order:


Visibility increases

private, default (no modifier), protected, public

Table 11.2 summarizes the accessibility of the members in a class. Figure 11.5 illustrates how a public, protected, default, and private datum or method in class `C1` can be accessed from a class `C2` in the same package, from a subclass `C3` in the same package, from a subclass `C4` in a different package, and from a class `C5` in a different package.

Use the `private` modifier to hide the members of the class completely so that they cannot be accessed directly from outside the class. Use no modifiers (the default) in order to allow the members of the class to be accessed directly from any class within the same package but not from other packages. Use the `protected` modifier to enable the members of the class to be accessed by the subclasses in any package or classes in the same package. Use the `public` modifier to enable the members of the class to be accessed by any class.

Your class can be used in two ways: (1) for creating instances of the class and (2) for defining subclasses by extending the class. Make the members `private` if they are not intended



why protected?

TABLE 11.2 Data and Methods Visibility

Modifier on members in a class	Accessed from the same class	Accessed from the same package	Accessed from a subclass in a different package	Accessed from a different package
public	✓	✓	✓	✓
protected	✓	✓	✓	–
default (no modifier)	✓	✓	–	–
private	✓	–	–	–

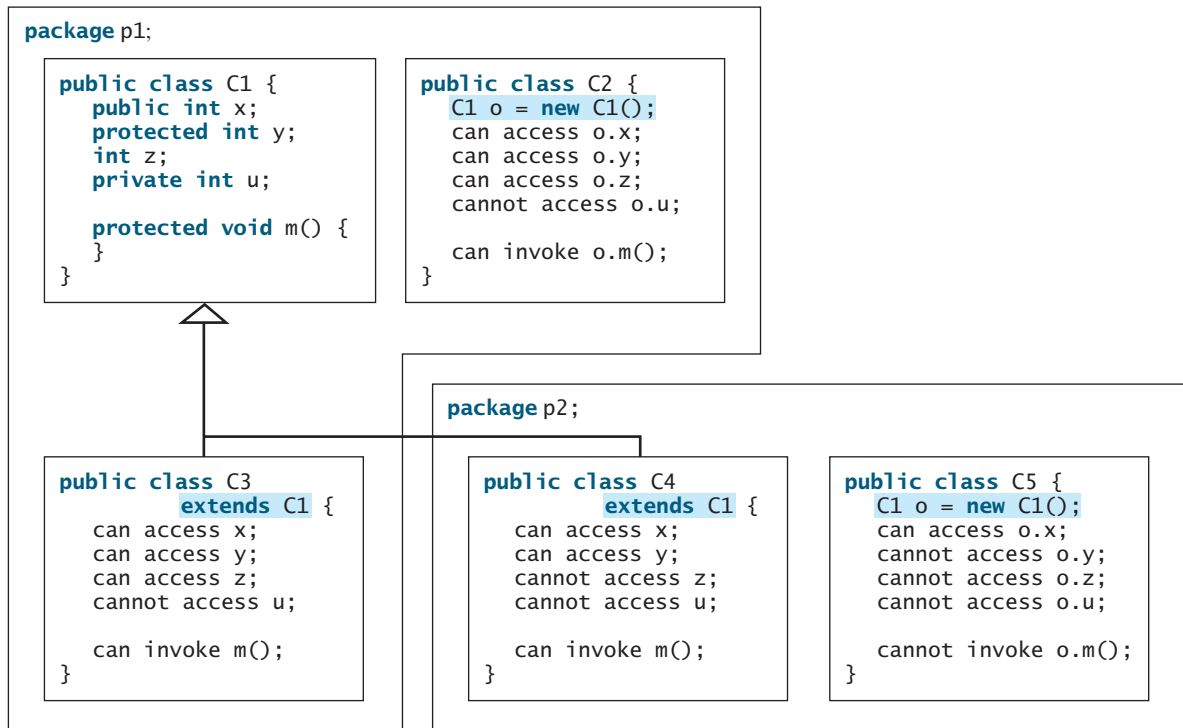


FIGURE 11.5 Visibility modifiers are used to control how data and methods are accessed.

for use from outside the class. Make the members **public** if they are intended for the users of the class. Make the fields or methods **protected** if they are intended for the extenders of the class but not for the users of the class.

The **private** and **protected** modifiers can be used only for members of the class. The **public** modifier and the default modifier (i.e., no modifier) can be used on members of the class as well as on the class. A class with no modifier (i.e., not a public class) is not accessible by classes from other packages.

change visibility



Note

A subclass may override a protected method defined in its superclass and change its visibility to public. However, a subclass cannot weaken the accessibility of a method defined in the superclass. For example, if a method is defined as public in the superclass, it must be defined as public in the subclass.

- 11.33** What modifier should you use on a class so that a class in the same package can access it, but a class in a different package cannot access it?
- 11.34** What modifier should you use so that a class in a different package cannot access the class, but its subclasses in any package can access it?
- 11.35** In the following code, the classes **A** and **B** are in the same package. If the question marks in (a) are replaced by blanks, can class **B** be compiled? If the question marks are replaced by **private**, can class **B** be compiled? If the question marks are replaced by **protected**, can class **B** be compiled?



MyProgrammingLab™

```
package p1;

public class A {
    ? int i;
    ? void m() {
        ...
    }
}
```

(a)

```
package p1;

public class B extends A {
    public void m1(String[] args) {
        System.out.println(i);
        m();
    }
}
```

(b)

- 11.36** In the following code, the classes **A** and **B** are in different packages. If the question marks in (a) are replaced by blanks, can class **B** be compiled? If the question marks are replaced by **private**, can class **B** be compiled? If the question marks are replaced by **protected**, can class **B** be compiled?

```
package p1;

public class A {
    ? int i;
    ? void m() {
        ...
    }
}
```

(a)

```
package p2;

public class B extends A {
    public void m1(String[] args) {
        System.out.println(i);
        m();
    }
}
```

(b)

11.14 Preventing Extending and Overriding

Neither a final class nor a final method can be extended. A final data field is a constant.



You may occasionally want to prevent classes from being extended. In such cases, use the **final** modifier to indicate that a class is final and cannot be a parent class. The **Math** class is a final class. The **String**, **StringBuilder**, and **StringBuffer** classes are also final classes. For example, the following class **A** is final and cannot be extended:

```
public final class A {
    // Data fields, constructors, and methods omitted
}
```

You also can define a method to be final; a final method cannot be overridden by its subclasses.

For example, the following method `m` is final and cannot be overridden:

```
public class Test {
    // Data fields, constructors, and methods omitted

    public final void m() {
        // Do something
    }
}
```



Note

The modifiers `public`, `protected`, `private`, `static`, `abstract`, and `final` are used on classes and class members (data and methods), except that the `final` modifier can also be used on local variables in a method. A `final` local variable is a constant inside a method.



11.37 How do you prevent a class from being extended? How do you prevent a method from being overridden?

MyProgrammingLab™

11.38 Indicate true or false for the following statements:

- a. A protected datum or method can be accessed by any class in the same package.
- b. A protected datum or method can be accessed by any class in different packages.
- c. A protected datum or method can be accessed by its subclasses in any package.
- d. A final class can have instances.
- e. A final class can be extended.
- f. A final method can be overridden.

KEY TERMS

actual type	422	override	419
casting objects	425	polymorphism	422
constructor chaining	415	protected	437
declared type	422	single inheritance	414
dynamic binding	422	subclass	408
inheritance	408	subtype	421
instanceof	426	superclass	408
is-a relationship	437	supertype	421
method overriding	419	type inference	431
multiple inheritance	414		

CHAPTER SUMMARY

1. You can define a new class from an existing class. This is known as class *inheritance*. The new class is called a *subclass*, *child class*, or *extended class*. The existing class is called a *superclass*, *parent class*, or *base class*.

2. A constructor is used to construct an instance of a class. Unlike properties and methods, the constructors of a superclass are not inherited in the subclass. They can be invoked only from the constructors of the subclasses, using the keyword **super**.
3. A constructor may invoke an overloaded constructor or its superclass's constructor. The call must be the first statement in the constructor. If none of them is invoked explicitly, the compiler puts **super()** as the first statement in the constructor, which invokes the superclass's no-arg constructor.
4. To *override* a method, the method must be defined in the subclass using the same signature and the same return type as in its superclass.
5. An instance method can be overridden only if it is accessible. Thus, a private method cannot be overridden because it is not accessible outside its own class. If a method defined in a subclass is private in its superclass, the two methods are completely unrelated.
6. Like an instance method, a static method can be inherited. However, a static method cannot be overridden. If a static method defined in the superclass is redefined in a subclass, the method defined in the superclass is hidden.
7. Every class in Java is descended from the **java.lang.Object** class. If no superclass is specified when a class is defined, its superclass is **Object**.
8. If a method's parameter type is a superclass (e.g., **Object**), you may pass an object to this method of any of the parameter's subclasses (e.g., **Circle** or **String**). This is known as polymorphism.
9. It is always possible to cast an instance of a subclass to a variable of a superclass, because an instance of a subclass is *always* an instance of its superclass. When casting an instance of a superclass to a variable of its subclass, explicit casting must be used to confirm your intention to the compiler with the (**SubClassName**) cast notation.
10. A class defines a type. A type defined by a subclass is called a *subtype* and a type defined by its superclass is called a *supertype*.
11. When invoking an instance method from a reference variable, the *actual type* of the variable decides which implementation of the method is used *at runtime*. This is known as dynamic binding.
12. You can use **obj instanceof AClass** to test whether an object is an instance of a class.
13. You can use the **ArrayList** class to create an object to store a list of objects.
14. You can use the **protected** modifier to prevent the data and methods from being accessed by nonsubclasses from a different package.
15. You can use the **final** modifier to indicate that a class is final and cannot be extended and to indicate that a method is final and cannot be overridden.

TEST QUESTIONS

Do the test questions for this chapter online at www.cs.armstrong.edu/liang/intro9e/test.html.

MyProgrammingLab™

PROGRAMMING EXERCISES

Sections 11.2–11.4

11.1 (The *Triangle* class) Design a class named **Triangle** that extends **GeometricObject**. The class contains:

- Three **double** data fields named **side1**, **side2**, and **side3** with default values **1.0** to denote three sides of the triangle.
- A no-arg constructor that creates a default triangle.
- A constructor that creates a triangle with the specified **side1**, **side2**, and **side3**.
- The accessor methods for all three data fields.
- A method named **getArea()** that returns the area of this triangle.
- A method named **getPerimeter()** that returns the perimeter of this triangle.
- A method named **toString()** that returns a string description for the triangle.

For the formula to compute the area of a triangle, see Programming Exercise 2.15. The **toString()** method is implemented as follows:

```
return "Triangle: side1 = " + side1 + " side2 = " + side2 +
    " side3 = " + side3;
```

Draw the UML diagrams for the classes **Triangle** and **GeometricObject** and implement the classes. Write a test program that prompts the user to enter three sides of the triangle, a color, and a Boolean value to indicate whether the triangle is filled. The program should create a **Triangle** object with these sides and set the **color** and **filled** properties using the input. The program should display the area, perimeter, color, and true or false to indicate whether it is filled or not.

Sections 11.5–11.14

11.2 (The *Person*, *Student*, *Employee*, *Faculty*, and *Staff* classes) Design a class named **Person** and its two subclasses named **Student** and **Employee**. Make **Faculty** and **Staff** subclasses of **Employee**. A person has a name, address, phone number, and email address. A student has a class status (freshman, sophomore, junior, or senior). Define the status as a constant. An employee has an office, salary, and date hired. Use the **MyDate** class defined in Programming Exercise 10.14 to create an object for date hired. A faculty member has office hours and a rank. A staff member has a title. Override the **toString** method in each class to display the class name and the person's name.

Draw the UML diagram for the classes and implement them. Write a test program that creates a **Person**, **Student**, **Employee**, **Faculty**, and **Staff**, and invokes their **toString()** methods.

11.3 (Subclasses of *Account*) In Programming Exercise 8.7, the **Account** class was defined to model a bank account. An account has the properties account number, balance, annual interest rate, and date created, and methods to deposit and withdraw funds. Create two subclasses for checking and saving accounts. A checking account has an overdraft limit, but a savings account cannot be overdrawn.

Draw the UML diagram for the classes and then implement them. Write a test program that creates objects of **Account**, **SavingsAccount**, and **CheckingAccount** and invokes their **toString()** methods.

- 11.4** (*Maximum element in ArrayList*) Write the following method that returns the maximum value in an **ArrayList** of integers. The method returns **null** if the list is **null** or the list size is **0**.

```
public static Integer max(ArrayList<Integer> list)
```

Write a test program that prompts the user to enter a sequence of numbers ending with **0**, and invokes this method to return the largest number in the input.

- 11.5** (*The Course class*) Rewrite the **Course** class in Listing 10.6. Use an **ArrayList** to replace an array to store students. You should not change the original contract of the **Course** class (i.e., the definition of the constructors and methods should not be changed).
- 11.6** (*Use ArrayList*) Write a program that creates an **ArrayList** and adds a **Loan** object, a **Date** object, a string, a **JFrame** object, and a **Circle** object to the list, and use a loop to display all the elements in the list by invoking the object's **toString()** method.
- 11.7** (*Shuffle ArrayList*) Write the following method that shuffles the elements in an **ArrayList** of integers.

```
public static void shuffle(ArrayList<Integer> list)
```

- ** 11.8** (*New Account class*) An **Account** class was specified in Programming Exercise 8.7. Design a new **Account** class as follows:

- Add a new data field **name** of the **String** type to store the name of the customer.
- Add a new constructor that constructs an account with the specified name, id, and balance.
- Add a new data field named **transactions** whose type is **ArrayList** that stores the transaction for the accounts. Each transaction is an instance of the **Transaction** class. The **Transaction** class is defined as shown in Figure 11.6.



VideoNote

New Account class

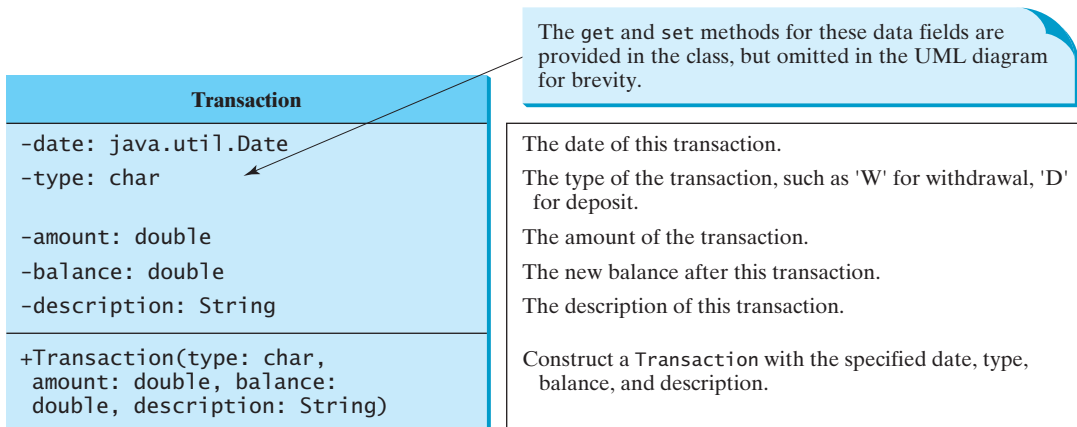


FIGURE 11.6 The **Transaction** class describes a transaction for a bank account.

- Modify the **withdraw** and **deposit** methods to add a transaction to the **transactions** array list.
- All other properties and methods are the same as in Programming Exercise 8.7.

Write a test program that creates an **Account** with annual interest rate **1.5%**, balance **1000**, id **1122**, and name **George**. Deposit \$30, \$40, and \$50 to the account and withdraw \$5, \$4, and \$2 from the account. Print an account summary that shows account holder name, interest rate, balance, and all transactions.

- *11.9** (*Largest rows and columns*) Write a program that randomly fills in **0s** and **1s** into an n-by-n matrix, prints the matrix, and finds the rows and columns with the most **1s**. (*Hint: Use two **ArrayLists** to store the row and column indices with the most **1s**.*) Here is a sample run of the program:



```
Enter the array size n: 4 
The random array is
0011
0011
1101
1010
The largest row index: 2
The largest column index: 2, 3
```

- 11.10** (*Implement **MyStack** using inheritance*) In Listing 11.10, **MyStack** is implemented using composition. Define a new stack class that extends **ArrayList**. Draw the UML diagram for the classes and then implement **MyStack**. Write a test program that prompts the user to enter five strings and displays them in reverse order.
- 11.11** (*Sort **ArrayList***) Write the following method that sorts an **ArrayList** of numbers:

```
public static void sort(ArrayList<Integer> list)
```

Write a test program that prompts the user to enter 5 numbers, stores them in an array list, and displays them in increasing order.

- 11.12** (*Sum **ArrayList***) Write the following method that returns the sum of all numbers in an **ArrayList**:

```
public static double sum(ArrayList<Double> list)
```

Write a test program that prompts the user to enter 5 numbers, stores them in an array list, and displays their sum.

GUI BASICS

Objectives

- To distinguish between Swing and AWT (§12.2).
- To describe the Java GUI API hierarchy (§12.3).
- To create user interfaces using frames, panels, and simple GUI components (§12.4).
- To understand the role of layout managers and use the **FlowLayout**, **GridLayout**, and **BorderLayout** managers to lay out components in a container (§12.5).
- To use **JPanel** to group components in a subcontainer (§12.6).
- To create objects for colors using the **Color** class (§12.7).
- To create objects for fonts using the **Font** class (§12.8).
- To apply common features such as borders, tool tips, fonts, and colors on Swing components (§12.9).
- To decorate the border of GUI components (§12.9).
- To create image icons using the **ImageIcon** class (§12.10).
- To create and use buttons using the **JButton** class (§12.11).
- To create and use check boxes using the **JCheckBox** class (§12.12).
- To create and use radio buttons using the **JRadioButton** class (§12.13).
- To create and use labels using the **JLabel** class (§12.14).
- To create and use text fields using the **JTextField** class (§12.15).



12.1 Introduction



Java GUI is an excellent pedagogical tool for learning object-oriented programming.

The design of the API for Java GUI programming is an excellent example of how the object-oriented principle is applied. This chapter serves two purposes. First, it presents the basics of Java GUI programming. Second, it uses GUI to demonstrate OOP. Specifically, this chapter introduces the framework of the Java GUI API and discusses GUI components and their relationships, containers and layout managers, colors, fonts, borders, image icons, and tool tips. It also introduces some of the most frequently used GUI components.

12.2 Swing vs. AWT



AWT GUI components are replaced by more versatile and stable Swing GUI components.

We used simple GUI examples to demonstrate OOP in Section 8.6.3, Displaying GUI Components. We used the GUI components such as `JButton`, `JLabel`, `TextField`, `JRadioButton`, and `JComboBox`. Why do the GUI component classes have the prefix *J*? Instead of `JButton`, why not name it simply `Button`? In fact, there is a class already named `Button` in the `java.awt` package.

When Java was introduced, the GUI classes were bundled in a library known as the *Abstract Windows Toolkit (AWT)*. AWT is fine for developing simple graphical user interfaces, but not for developing comprehensive GUI projects. In addition, AWT is prone to platform-specific bugs. The AWT user-interface components were replaced by a more robust, versatile, and flexible library known as *Swing components*. Swing components are painted directly on canvases using Java code, except for components that are subclasses of `java.awt.Window` or `java.awt.Panel`, which must be drawn using native GUI on a specific platform. Swing components depend less on the target platform and use less of the native GUI resource. For this reason, Swing components that don't rely on native GUI are referred to as *lightweight components*, and AWT components are referred to as *heavyweight components*.

To distinguish new Swing component classes from their AWT counterparts, the Swing GUI component classes are named with a prefixed *J*. Although AWT components are still supported in Java, it is better to learn how to program using Swing components, because the AWT user-interface components will eventually fade away. This book uses Swing GUI components exclusively.

AWT

Swing components

lightweight component
heavyweight component
why prefix J?



12.1 Why are the Swing GUI classes named with the prefix *J*?

12.2 Explain the difference between AWT GUI components and Swing GUI components.

MyProgrammingLab™

12.3 The Java GUI API



The GUI API contains classes that can be classified into three groups: component classes, container classes, and helper classes.

The hierarchical relationships of the Java GUI API are shown in Figure 12.1. Recall that the triangular arrow denotes the inheritance relationship, the diamond denotes the composition relationship, and the filled diamond denotes the exclusive composition relationship. The object composition relationship was introduced in Section 10.7.

The subclasses of `Component` are called *component classes* for creating the user interface. The classes, such as `JFrame`, `JPanel`, and `JApplet`, are called *container classes* used to contain other components. The classes, such as `Graphics`, `Color`, `Font`, `FontMetrics`, and `Dimension`, are called *helper classes* used to support GUI components.

component class
container class

helper class

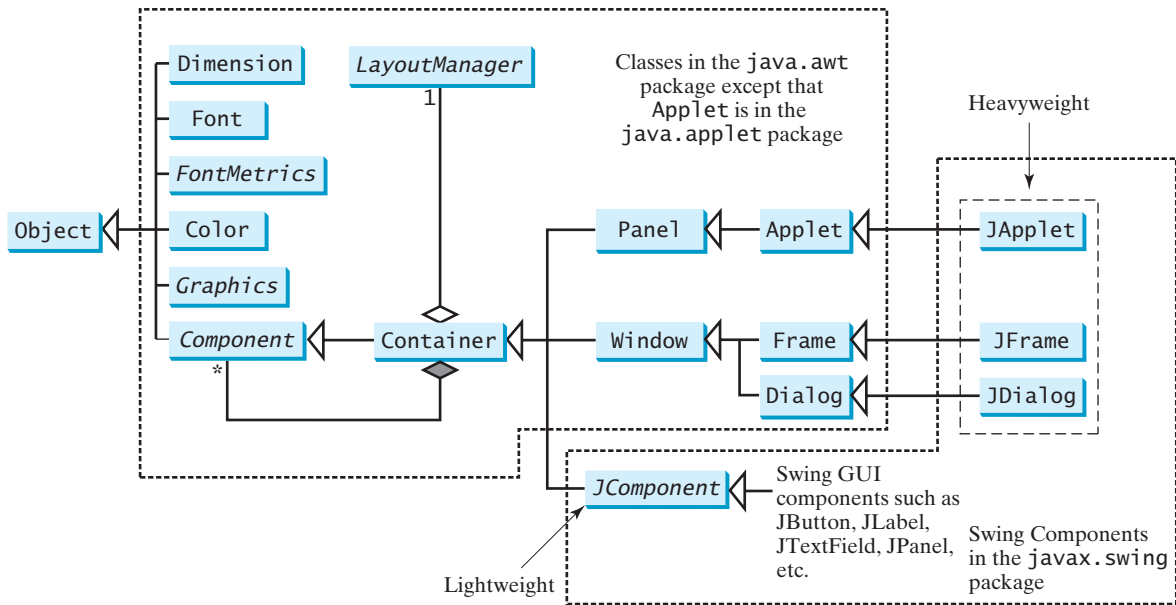


FIGURE 12.1 Java GUI programming utilizes the classes shown in this hierarchical diagram.



Note

The **JFrame**, **JApplet**, **JDialog**, and **JComponent** classes and their subclasses are grouped in the **javax.swing** package. **Applet** is in the **java.applet** class. All the other classes in Figure 12.1 are grouped in the **java.awt** package.

12.3.1 Component Classes

An instance of **Component** can be displayed on the screen. **Component** is the root class of all the user-interface classes including container classes, and **JComponent** is the root class of all the lightweight Swing components. Both **Component** and **JComponent** are abstract classes (abstract classes will be introduced in Chapter 15). For now, all you need to know is that abstract classes are the same as classes except that you cannot create instances using the **new** operator. For example, you cannot use **new JComponent()** to create an instance of **JComponent**. However, you can use the constructors of concrete subclasses of **JComponent** to create **JComponent** instances. It is important to become familiar with the class inheritance hierarchy. For example, the following statements all display true:

abstract class

```
JButton jbtOK = new JButton("OK");
System.out.println(jbtOK instanceof JButton);
System.out.println(jbtOK instanceof JComponent);
System.out.println(jbtOK instanceof Container);
System.out.println(jbtOK instanceof Component);
System.out.println(jbtOK instanceof Object);
```

12.3.2 Container Classes

An instance of **Container** can hold instances of **Component**. A container is called a *top-level container* if it can be displayed without being embedded in another container. **Window**, **Frame**, **Dialog**, **JFrame**, and **JDialog** are top-level containers. **Window**, **Panel**, **Applet**, **Frame**, and **Dialog** are the container classes for AWT components. To work with Swing components, use **Container**, **JFrame**, **JDialog**, **JApplet**, and **JPanel**, as described in Table 12.1.

top-level container

TABLE 12.1 GUI Container Classes

<i>Container Class</i>	<i>Description</i>
<code>java.awt.Container</code>	is used to hold components. Frames, panels, and applets are its subclasses.
<code>javax.swing.JFrame</code>	is a top-level container for holding other Swing user-interface components in Java GUI applications.
<code>javax.swing.JPanel</code>	is an invisible container for grouping user-interface components. Panels can be nested. You can place panels inside another panel. <code>JPanel</code> is also often used as a canvas to draw graphics.
<code>javax.swing.JApplet</code>	is a base class for creating a Java applet using Swing components.
<code>javax.swing.JDialog</code>	is a popup window generally used as a temporary window to receive additional information from the user or to provide notification to the user.

12.3.3 GUI Helper Classes

The helper classes, such as `Graphics`, `Color`, `Font`, `FontMetrics`, `Dimension`, and `LayoutManager`, are not subclasses of `Component`. They are used to describe the properties of GUI components, such as graphics context, colors, fonts, and dimension, as described in Table 12.2.

TABLE 12.2 GUI Helper Classes

<i>Helper Class</i>	<i>Description</i>
<code>java.awt.Graphics</code>	is an abstract class that provides the methods for drawing strings, lines, and simple shapes.
<code>java.awt.Color</code>	deals with the colors of GUI components. For example, you can specify background or foreground colors in components like <code>JFrame</code> and <code>JPanel</code> , or you can specify colors of lines, shapes, and strings in drawings.
<code>java.awt.Font</code>	specifies fonts for the text and drawings on GUI components. For example, you can specify the font type (e.g., <code>SansSerif</code>), style (e.g., <code>bold</code>), and size (e.g., 24 points) for the text on a button.
<code>java.awt.FontMetrics</code>	is an abstract class used to get the properties of the fonts.
<code>java.awt.Dimension</code>	encapsulates the width and height of a component (in integer precision) in a single object.
<code>java.awt.LayoutManager</code>	specifies how components are arranged in a container.



Note

The helper classes are in the `java.awt` package. The Swing components do not replace all the classes in the AWT, only the AWT GUI component classes (e.g., `Button`, `TextField`, `TextArea`). The AWT helper classes are still useful in GUI programming.



12.3 Which class is the root of the Java GUI component classes? Is a container class a subclass of `Component`? Which class is the root of the Swing GUI component classes?

12.4 Which of the following statements have syntax errors?

```
Component c1 = new Component();
JComponent c2 = new JComponent();
Component c3 = new JButton();
JComponent c4 = new JButton();
```

12.4 Frames

A frame is a window for holding other GUI components.

To create a user interface, you need to create either a frame or an applet to hold the user-interface components. This section introduces frames. Creating Java applets will be introduced in Chapter 18.



12.4.1 Creating a Frame

To create a frame, use the `JFrame` class, as shown in Figure 12.2.

javax.swing.JFrame	
<pre>+JFrame() +JFrame(title: String) +setSize(width: int, height: int): void +setLocation(x: int, y: int): void +setVisible(visible: boolean): void +setDefaultCloseOperation(mode: int): void +setLocationRelativeTo(c: Component): void +pack(): void</pre>	<pre>Creates a default frame with no title. Creates a frame with the specified title. Sets the size of the frame. Sets the upper-left-corner location of the frame. Sets true to display the frame. Specifies the operation when the frame is closed. Sets the location of the frame relative to the specified component. If the component is null, the frame is centered on the screen. Automatically sets the frame size to hold the components in the frame.</pre>

FIGURE 12.2 The `JFrame` class is used to create a window for displaying GUI components.

The program in Listing 12.1 creates a frame.

LISTING 12.1 MyFrame.java

```
1 import javax.swing.JFrame;           import package
2
3 public class MyFrame {
4     public static void main(String[] args) {
5         JFrame frame = new JFrame("MyFrame"); // Create a frame      create frame
6         frame.setSize(400, 300); // Set the frame size                set size
7         frame.setLocationRelativeTo(null); // Center a frame         center frame
8         frame.setDefaultCloseOperation(JFrame.EXIT_ON_CLOSE);      close upon exit
9         frame.setVisible(true); // Display the frame                  display the frame
10    }
11 }
```

The frame is not displayed until the `frame.setVisible(true)` method is invoked. `frame.setSize(400, 300)` specifies that the frame is 400 pixels wide and 300 pixels high. If the `setSize` method is not used, the frame will be sized to display just the title bar. Since the `setSize` and `setVisible` methods are both defined in the `Component` class, they are inherited by the `JFrame` class. Later you will see that these methods are also useful in many other subclasses of `Component`.

When you run the `MyFrame` program, a window will be displayed on the screen (see Figure 12.3a).

Invoking `setLocationRelativeTo(null)` (line 7) centers the frame on the screen. Invoking `setDefaultCloseOperation(JFrame.EXIT_ON_CLOSE)` (line 8) tells the program to terminate when the frame is closed. If this statement is not used, the program does not terminate when the frame is closed. In that case, you have to stop the program by pressing `Ctrl+C` at the DOS prompt window in Windows or stop the process by using the kill command



FIGURE 12.3 (a) The program creates and displays a frame with the title `MyFrame`. (b) An OK button is added to the frame.

in UNIX. If you run the program from an IDE such as Eclipse or NetBeans, you need to click the red *Terminate* button in the Console pane to stop the program.

pixel and resolution



Note

Recall that a pixel is the smallest unit of space available for drawing on the screen. You can think of a pixel as a small rectangle and think of the screen as paved with pixels. The *resolution* specifies the number of pixels in horizontal and vertical dimensions of the screen. The more pixels the screen has, the higher the screen's resolution. The higher the resolution, the finer the detail you can see.

setSize before centering



Note

You should invoke the `setSize(w, h)` method before invoking `setLocationRelativeTo(null)` to center the frame.

12.4.2 Adding Components to a Frame

The frame shown in Figure 12.3a is empty. Using the `add` method, you can add components to the frame, as shown in Listing 12.2.

LISTING 12.2 `MyFrameWithComponents.java`

create a button
add to frame

set size
exit upon closing window
center the frame
set visible

```

1  import javax.swing.*;
2
3  public class MyFrameWithComponents {
4      public static void main(String[] args) {
5          JFrame frame = new JFrame("MyFrameWithComponents");
6
7          // Add a button to the frame
8          JButton jbtOK = new JButton("OK");
9          frame.add(jbtOK);
10
11         frame.setSize(400, 300);
12         frame.setDefaultCloseOperation(JFrame.EXIT_ON_CLOSE);
13         frame.setLocationRelativeTo(null); // Center the frame
14         frame.setVisible(true);
15     }
16 }
```

Each `JFrame` contains a *content pane*, which is an instance of `java.awt.Container`. The GUI components such as buttons are placed in the content pane in a frame. In earlier versions of Java, you had to use the `getContentPane` method in the `JFrame` class to return the content pane of the frame, then invoke the content pane's `add` method to place a component in the content pane, as follows:

```

java.awt.Container container = frame.getContentPane();
container.add(jbtOK);
```

This was cumbersome. Versions of Java since Java 5 allow you to place components in the content pane by invoking a frame's `add` method, as follows:

```
frame.add(jbtOK);
```

This feature is called *content-pane delegation*. Strictly speaking, a component is added to the content pane of a frame. For simplicity, we say that a component is added to a frame.

content-pane delegation

In Listing 12.2, an object of `JButton` was created using `new JButton("OK")`, and this object was added to the content pane of the frame (line 9).

The `add(Component comp)` method defined in the `Container` class adds an instance of `Component` to the container. Since `JButton` is a subclass of `Component`, an instance of `JButton` is also an instance of `Component`. To remove a component from a container, use the `remove` method. The following statement removes the button from the container:

```
container.remove(jbtOK);
```

When you run the program `MyFrameWithComponents`, the window will be displayed as in Figure 12.3b. The button is always centered in the frame and occupies the entire frame no matter how you resize it. This is because components are put in the frame by the content pane's layout manager, and the default layout manager for the content pane places the button in the center. In the next section, you will use several different layout managers to place components in the desired locations.

12.5 How do you create a frame? How do you set the size for a frame? How do you add components to a frame? What would happen if the statements `frame.setSize(400, 300)` and `frame.setVisible(true)` were swapped in Listing 12.2?



MyProgrammingLab™

12.5 Layout Managers

Each container contains a layout manager, which is an object responsible for laying out the GUI components in the container.



In many other window systems, the user-interface components are arranged by using hard-coded pixel measurements. For example, when placing a button at location (10, 10) in a window using hard-coded pixel measurements, the user interface might look fine on one system but be unusable on another. Java's *layout managers* provide a level of abstraction that automatically maps your user interface on all window systems.

layout manager

The Java GUI components are placed in containers, where they are arranged by the container's layout manager. In the preceding program, you did not specify where to place the `OK` button in the frame, but Java knows where to place it, because the layout manager works behind the scenes to place components in the correct locations. A layout manager is created using a layout manager class.

Layout managers are set in containers using the `setLayout(aLayoutManager)` method. For example, you can use the following statements to create an instance of `XLayout` and set it in a container:

```
LayoutManager layoutManager = new XLayout();
container.setLayout(layoutManager);
```

This section introduces three basic layout managers: `FlowLayout`, `GridLayout`, and `BorderLayout`.



VideoNote

Use FlowLayout

12.5.1 FlowLayout

FlowLayout is the simplest layout manager. The components are arranged in the container from left to right in the order in which they were added. When one row is filled, a new row is started. You can specify the way the components are aligned by using one of three constants: **FlowLayout.RIGHT**, **FlowLayout.CENTER**, or **FlowLayout.LEFT**. You can also specify the gap between components in pixels. The class diagram for **FlowLayout** is shown in Figure 12.4.

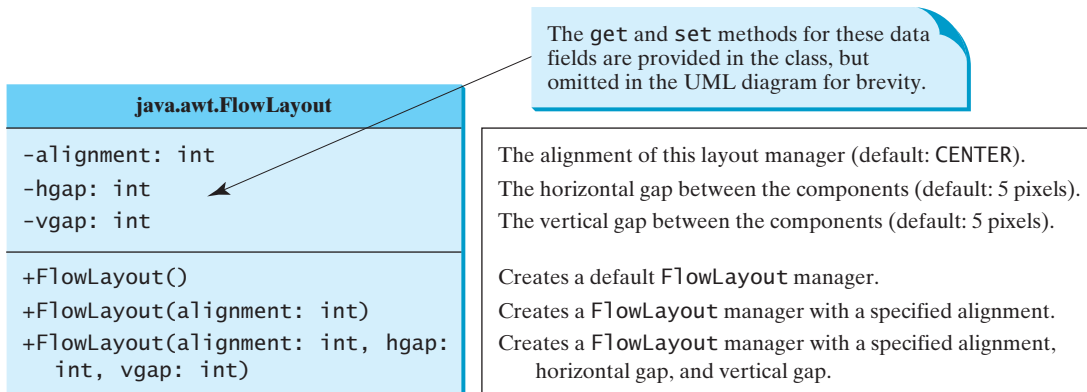


FIGURE 12.4 **FlowLayout** lays out components row by row.

Listing 12.3 gives a program that demonstrates flow layout. The program adds three labels and text fields to the frame with a **FlowLayout** manager, as shown in Figure 12.5.

LISTING 12.3 ShowFlowLayout.java

```

1  import javax.swing.JLabel;
2  import javax.swing.JTextField;
3  import javax.swing.JFrame;
4  import java.awt.FlowLayout;
5
6  extends JFrame
7  public class ShowFlowLayout extends JFrame {
8      public ShowFlowLayout() {
9          // Set FlowLayout, aligned left with horizontal gap 10
10         // and vertical gap 20 between components
11         setLayout(new FlowLayout(FlowLayout.LEFT, 10, 20));
12
13         // Add labels and text fields to the frame
14         add(new JLabel("First Name"));
15         add(new JTextField(8));
16         add(new JLabel("MI"));
17         add(new JTextField(1));
18         add(new JLabel("Last Name"));
19         add(new JTextField(8));
20     }
21
22     /** Main method */
23     public static void main(String[] args) {
24         ShowFlowLayout frame = new ShowFlowLayout();
25         frame.setTitle("ShowFlowLayout");
26         frame.setSize(200, 200);

```



```

26     frame.setLocationRelativeTo(null); // Center the frame
27     frame.setDefaultCloseOperation(JFrame.EXIT_ON_CLOSE);
28     frame.setVisible(true);
29 }
30 }

```

create frame
set visible

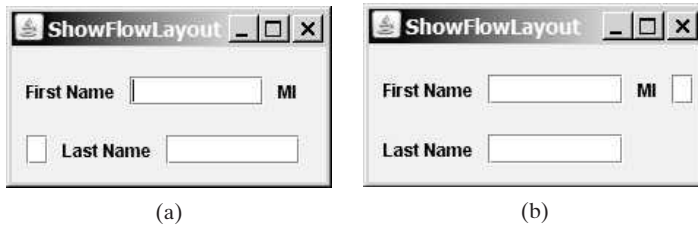


FIGURE 12.5 The components are added by the **FlowLayout** manager to fill in the rows in the container one after another.

This example creates a program using a style different from the programs in the preceding section, where frames were created using the **JFrame** class. This example creates a class named **ShowFlowLayout** that extends the **JFrame** class (line 6). The **main** method in this program creates an instance of **ShowFlowLayout** (line 23). The constructor of **ShowFlowLayout** constructs and places the components in the frame. This is the preferred style of creating GUI applications—for three reasons:

- Creating a GUI application means creating a frame, so it is natural to define a frame to extend **JFrame**.
- The frame may be further extended to add new components or functions.
- The class can be easily reused. For example, you can create multiple frames by creating multiple instances of the class.

Using one style consistently makes programs easy to read. From now on, most of the GUI main classes will extend the **JFrame** class. The constructor of the main class constructs the user interface. The **main** method creates an instance of the main class and then displays the frame.

Will the program work if line 23 is replaced by the following code?

```
JFrame frame = new ShowFlowLayout();
```

Yes. The program will still work because **ShowFlowLayout** is a subclass of **JFrame** and the methods **setTitle**, **setSize**, **setLocationRelativeTo**, **setDefaultCloseOperation**, and **setVisible** (lines 24–28) are all available in the **JFrame** class.

In this example, the **FlowLayout** manager is used to place components in a frame. If you resize the frame, the components are automatically rearranged to fit. In Figure 12.5a, the first row has three components, but in Figure 12.5b, the first row has four components, because the width has been increased.

If you replace the **setLayout** statement (line 10) with **setLayout(new FlowLayout(FlowLayout.RIGHT, 0, 0))**, all the rows of buttons will be right aligned with no gaps.

An anonymous **FlowLayout** object was created in the statement (line 10):

```
setLayout(new FlowLayout(FlowLayout.LEFT, 10, 20));
```

which is equivalent to:

```
FlowLayout layout = new FlowLayout(FlowLayout.LEFT, 10, 20);
setLayout(layout);
```

This code creates an explicit reference to the object `layout` of the `FlowLayout` class. The explicit reference is not necessary, because the object is not directly referenced in the `ShowFlowLayout` class.

Suppose you add the same button to the frame ten times; will ten buttons appear in the frame? No, a GUI component such as a button can be added to only one container and only once in a container. Adding a button to a container multiple times is the same as adding it once.



Note

GUI components cannot be shared by containers, because only one GUI component can appear in only one container at a time. Therefore, the relationship between a component and a container is the composition denoted by a filled diamond, as shown in Figure 12.1.



Caution

Do not forget to put the `new` operator before a layout manager class when setting a layout style—for example, `setLayout(new FlowLayout())`.



Note

The constructor `ShowFlowLayout()` does not explicitly invoke the constructor `JFrame()`, but the constructor `JFrame()` is invoked implicitly. See Section 11.3.2, Constructor Chaining.

12.5.2 GridLayout

The `GridLayout` manager arranges components in a grid (matrix) formation. The components are placed in the grid from left to right, starting with the first row, then the second, and so on, in the order in which they are added. The class diagram for `GridLayout` is shown in Figure 12.6.

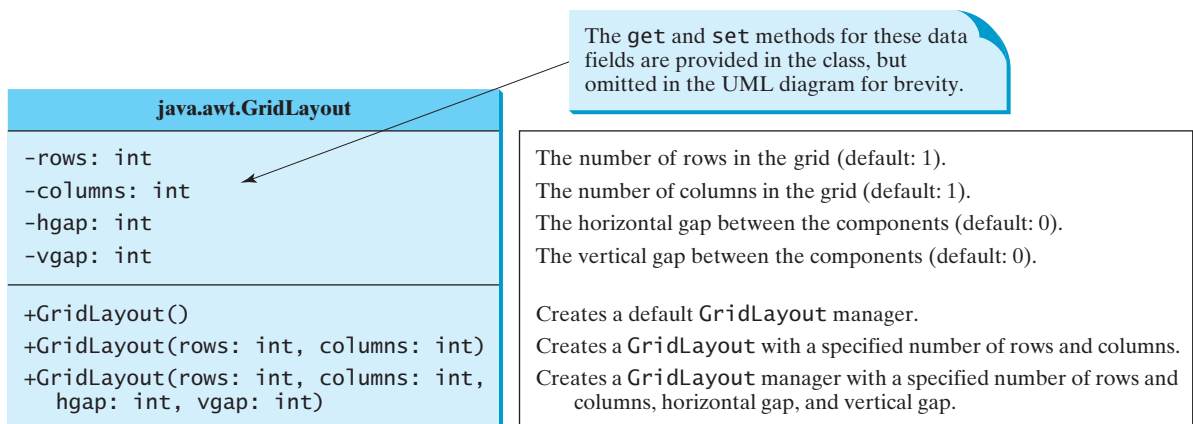


FIGURE 12.6 `GridLayout` lays out components in equal-sized cells on a grid.

You can specify the number of rows and columns in the grid. The basic rules are as follows:

- The number of rows or the number of columns can be zero, but not for both. If one is zero and the other is nonzero, the nonzero dimension is fixed, while the zero dimension is determined dynamically by the layout manager. For example, if you specify zero rows and three columns for a grid that has ten components, `GridLayout` creates three fixed columns of four rows, with the last row containing one component. If you specify three rows and zero columns for a grid that has ten components, `GridLayout` creates three fixed rows of four columns, with the last row containing two components.

- If both the number of rows and the number of columns are nonzero, the number of rows is the dominating parameter; that is, the number of rows is fixed, and the layout manager dynamically calculates the number of columns. For example, if you specify three rows and three columns for a grid that has ten components, `GridLayout` creates three fixed rows of four columns, with the last row containing two components.

Listing 12.4 gives a program that demonstrates grid layout. The program is similar to the one in Listing 12.3, except that it adds three labels and three text fields to the frame of `GridLayout` instead of `FlowLayout`, as shown in Figure 12.7.



FIGURE 12.7 The `GridLayout` manager divides the container into grids; then the components are added to fill in the cells row by row.

LISTING 12.4 ShowGridLayout.java

```

1  import javax.swing.JLabel;
2  import javax.swing.JTextField;
3  import javax.swing.JFrame;
4  import java.awt.GridLayout;
5
6  public class ShowGridLayout extends JFrame {
7      public ShowGridLayout() {
8          // Set GridLayout, 3 rows, 2 columns, and gaps 5 between
9          // components horizontally and vertically
10         setLayout(new GridLayout(3, 2, 5, 5));           set layout
11
12         // Add labels and text fields to the frame
13         add(new JLabel("First Name"));                 add label
14         add(new JTextField(8));                         add text field
15         add(new JLabel("MI"));
16         add(new JTextField(1));
17         add(new JLabel("Last Name"));
18         add(new JTextField(8));
19     }
20
21     /** Main method */
22     public static void main(String[] args) {
23         ShowGridLayout frame = new ShowGridLayout();
24         frame.setTitle("ShowGridLayout");
25         frame.setSize(200, 125);
26         frame.setLocationRelativeTo(null); // Center the frame       create the frame
27         frame.setDefaultCloseOperation(JFrame.EXIT_ON_CLOSE);
28         frame.setVisible(true);                               set visible
29     }
30 }

```

If you resize the frame, the layout of the components remains unchanged (i.e., the number of rows and columns does not change, and the gaps don't change either).

All components are given equal size in the container of `GridLayout`.

Replacing the `setLayout` statement (line 10) with `setLayout(new GridLayout(3, 10))` would still yield three rows and *two* columns. The `columns` parameter is ignored

because the `rows` parameter is nonzero. The actual number of columns is calculated by the layout manager.

What would happen if the `setLayout` statement (line 10) were replaced with `setLayout(new GridLayout(4, 2))` or with `setLayout(new GridLayout(2, 2))`? Please try it yourself.



Note

In `FlowLayout` and `GridLayout`, the order in which the components are added to the container is important. The order determines the location of the components in the container.

12.5.3 BorderLayout

The `BorderLayout` manager divides a container into five areas: East, South, West, North, and Center. Components are added to a `BorderLayout` by using `add(Component, index)`, where `index` is a constant `BorderLayout.EAST`, `BorderLayout.SOUTH`, `BorderLayout.WEST`, `BorderLayout.NORTH`, or `BorderLayout.CENTER`. The class diagram for `BorderLayout` is shown in Figure 12.8.

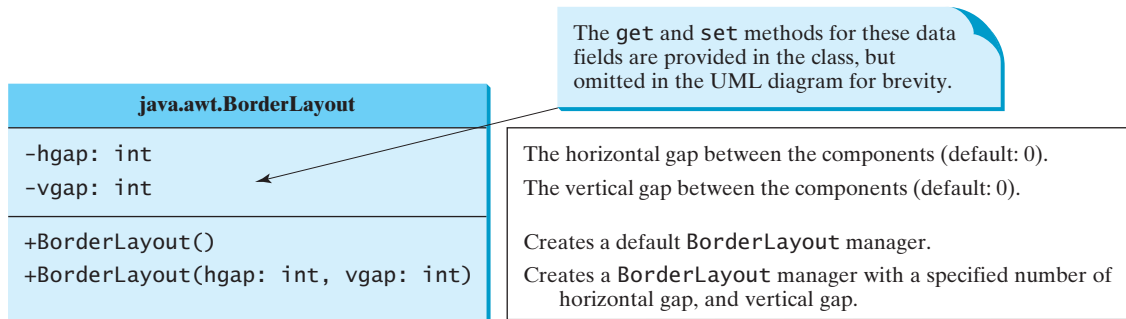


FIGURE 12.8 `BorderLayout` lays out components in five areas.

The components are laid out according to their preferred sizes and their placement in the container. The North and South components can stretch horizontally; the East and West components can stretch vertically; the Center component can stretch both horizontally and vertically to fill any empty space.

Listing 12.5 gives a program that demonstrates border layout. The program adds five buttons labeled `East`, `South`, `West`, `North`, and `Center` to the frame with a `BorderLayout` manager, as shown in Figure 12.9.



FIGURE 12.9 `BorderLayout` divides the container into five areas, each of which can hold a component.

LISTING 12.5 ShowBorderLayout.java

```

1 import javax.swing.JButton;
2 import javax.swing.JFrame;
3 import java.awt.BorderLayout;
  
```

```

4
5 public class ShowBorderLayout extends JFrame {
6     public ShowBorderLayout() {
7         // Set BorderLayout with horizontal gap 5 and vertical gap 10
8         setLayout(new BorderLayout(5, 10));           set layout
9
10        // Add buttons to the frame
11        add(new JButton("East"), BorderLayout.EAST);   add buttons
12        add(new JButton("South"), BorderLayout.SOUTH);
13        add(new JButton("West"), BorderLayout.WEST);
14        add(new JButton("North"), BorderLayout.NORTH);
15        add(new JButton("Center"), BorderLayout.CENTER);
16    }
17
18    /** Main method */
19    public static void main(String[] args) {
20        ShowBorderLayout frame = new ShowBorderLayout();
21        frame.setTitle("ShowBorderLayout");
22        frame.setSize(300, 200);
23        frame.setLocationRelativeTo(null); // Center the frame       create the frame
24        frame.setDefaultCloseOperation(JFrame.EXIT_ON_CLOSE);
25        frame.setVisible(true);                                       set visible
26    }
27 }

```

The buttons are added to the frame (lines 11–15). Note that the `add` method for `BorderLayout` is different from the one for `FlowLayout` and `GridLayout`. With `BorderLayout`, you specify where to put the components.

It is unnecessary to place components to occupy all the areas. If you remove the East button from the program and rerun it, you will see that the Center button stretches rightward to occupy the East area.



Note

`BorderLayout` interprets the absence of an index specification as `BorderLayout.CENTER`. For example, `add(component)` is the same as `add(Component, BorderLayout.CENTER)`. If you add two components to a container of `BorderLayout`, as follows,

```

container.add(component1);
container.add(component2);

```

only the last component is displayed.

12.5.4 Properties of Layout Managers

Layout managers have properties that can be changed dynamically.

- `FlowLayout` has `alignment`, `hgap`, and `vgap` properties. You can use the `setAlignment`, `setHgap`, and `setVgap` methods to specify the alignment and the horizontal and vertical gaps.
- `GridLayout` has the `rows`, `columns`, `hgap`, and `vgap` properties. You can use the `setRows`, `setColumns`, `setHgap`, and `setVgap` methods to specify the number of rows, the number of columns, and the horizontal and vertical gaps.
- `BorderLayout` has the `hgap` and `vgap` properties. You can use the `setHgap` and `setVgap` methods to specify the horizontal and vertical gaps.

In the preceding sections an anonymous layout manager is used because the properties of a layout manager do not change once it is created. If you have to change the properties of a layout manager dynamically, the layout manager must be explicitly referenced by a variable. You

can then change the properties of the layout manager through the variable. For example, the following code creates a layout manager and sets its properties:

```
// Create a layout manager
FlowLayout flowLayout = new FlowLayout();

// Set layout properties
flowLayout.setAlignment(FlowLayout.RIGHT);
flowLayout.setHgap(10);
flowLayout.setVgap(20);
```



MyProgrammingLab™

12.6 Will the program work if **ShowFlowLayout** in line 23 in Listing 12.3 is replaced by **JFrame**?

Will the program work if **ShowGridLayout** in line 23 in Listing 12.4 is replaced by **JFrame**?

Will the program work if **ShowBorderLayout** line 20 in Listing 12.5 is replaced by **JFrame**?

12.7 Why do you need to use layout managers? What is the default layout manager for a frame? How do you add a component to a frame?

12.8 Describe **FlowLayout**. How do you create a **FlowLayout** manager? How do you add a component to a **FlowLayout** container? Is there a limit to the number of components that can be added to a **FlowLayout** container? What are the properties for setting the horizontal and vertical gaps between the components in the container? Can you specify alignment?

12.9 Describe **GridLayout**. How do you create a **GridLayout** manager? How do you add a component to a **GridLayout** container? Is there a limit to the number of components that can be added to a **GridLayout** container? What are the properties for setting the horizontal and vertical gaps between the components in the container?

12.10 Describe **BorderLayout**. How do you create a **BorderLayout** manager? How do you add a component to a **BorderLayout** container? What are the properties for setting the horizontal and vertical gaps between the components in the container?

12.11 The following program is supposed to display a button in a frame, but nothing is displayed. What is the problem?

```
1 public class Test extends javax.swing.JFrame {
2     public Test() {
3         add(new javax.swing.JButton("OK"));
4     }
5
6     public static void main(String[] args) {
7         javax.swing.JFrame frame = new javax.swing.JFrame();
8         frame.setSize(100, 200);
9         frame.setVisible(true);
10    }
11 }
```

12.6 Using Panels as Subcontainers



A container can be placed inside another container. Panels can be used as subcontainers to group GUI components to achieve the desired layout.



VideoNote

Use panels as subcontainers

Suppose that you want to place ten buttons and a text field in a frame. The buttons are placed in grid formation, but the text field is placed on a separate row. It is difficult to achieve the desired look by placing all the components in a single container. With Java GUI programming, you can divide a window into panels. Panels act as subcontainers to group user-interface components. You add the buttons in one panel, then add the panel to the frame.

The Swing version of panel is `JPanel`. You can use `new JPanel()` to create a panel with a default `FlowLayout` manager or `new JPanel(LayoutManager)` to create a panel with the specified layout manager. Use the `add(Component)` method to add a component to the panel. For example, the following code creates a panel and adds a button to it:

```
JPanel p = new JPanel();
p.add(new JButton("OK"));
```

Panels can be placed inside a frame or inside another panel. The following statement places panel `p` in frame `f`:

```
f.add(p);
```

Listing 12.6 gives an example that demonstrates using panels as subcontainers. The program creates a user interface for a microwave oven, as shown in Figure 12.10.

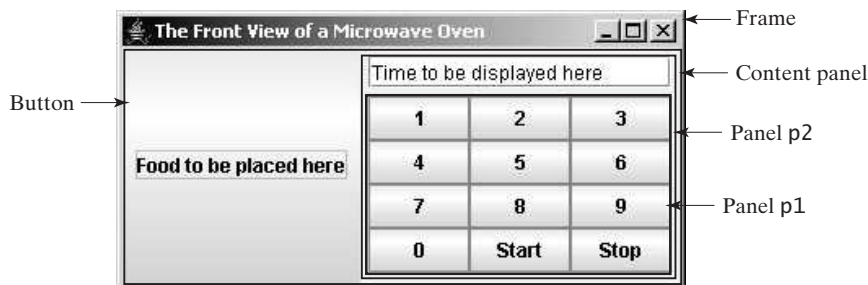


FIGURE 12.10 The program uses panels to organize components.

LISTING 12.6 TestPanels.java

```
1  import java.awt.*;
2  import javax.swing.*;
3
4  public class TestPanels extends JFrame {
5      public TestPanels() {
6          // Create panel p1 for the buttons and set GridLayout
7          JPanel p1 = new JPanel();
8          p1.setLayout(new GridLayout(4, 3));
9
10         // Add buttons to the panel
11         for (int i = 1; i <= 9; i++) {
12             p1.add(new JButton("" + i));
13         }
14
15         p1.add(new JButton("" + 0));
16         p1.add(new JButton("Start"));
17         p1.add(new JButton("Stop"));
18
19         // Create panel p2 to hold a text field and p1
20         JPanel p2 = new JPanel(new BorderLayout());
21         p2.add(new JTextField("Time to be displayed here"),
22             BorderLayout.NORTH);
23         p2.add(p1, BorderLayout.CENTER);
24
25         // Add contents to the frame
26         add(p2, BorderLayout.EAST);
27         add(new JButton("Food to be placed here"),
28             BorderLayout.CENTER);
29     }
30 }
```

panel p1

panel p2

add p2 to frame

```

31  /** Main method */
32  public static void main(String[] args) {
33      TestPanels frame = new TestPanels();
34      frame.setTitle("The Front View of a Microwave Oven");
35      frame.setSize(400, 250);
36      frame.setLocationRelativeTo(null); // Center the frame
37      frame.setDefaultCloseOperation(JFrame.EXIT_ON_CLOSE);
38      frame.setVisible(true);
39  }
40  }

```

The `setLayout` method is defined in `java.awt.Container`. Since `JPanel` is a subclass of `Container`, you can use `setLayout` to set a new layout manager in the panel (line 8). Lines 7–8 can be replaced by `JPanel p1 = new JPanel(new GridLayout(4, 3))`.

To achieve the desired layout, the program uses panel `p1` of `GridLayout` to group the number buttons, the *Stop* button, and the *Start* button, and panel `p2` of `BorderLayout` to hold a text field in the north and `p1` in the center. The button representing the food is placed in the center of the frame, and `p2` is placed in the east of the frame.

The statement (lines 21–22)

```
p2.add(new JTextField("Time to be displayed here"),
      BorderLayout.NORTH);
```

creates an instance of `JTextField` and adds it to `p2`. `JTextField` is a GUI component that can be used for user input as well as to display values.

superclass Container



Note

It is worthwhile to note that the `Container` class is the superclass for GUI component classes, such as `JButton`. Every GUI component is a container. In theory, you could use the `setLayout` method to set the layout in a button and add components to a button, because all the public methods in the `Container` class are inherited by `JButton`, but for practical reasons you should not use buttons as containers.



Check
Point

MyProgrammingLab™

12.12 How do you create a panel with a specified layout manager?

12.13 What is the default layout manager for a `JPanel`? How do you add a component to a `JPanel`?

12.14 Can you use the `setTitle` method in a panel? What is the purpose of using a panel?

12.15 Since a GUI component class such as `JButton` is a subclass of `Container`, can you add components to a button?

12.7 The Color Class



Key
Point

Each GUI component has background and foreground colors. Colors are objects created from the `Color` class.

You can set colors for GUI components by using the `java.awt.Color` class. Colors are made of red, green, and blue components, each represented by an `int` value that describes its intensity, ranging from `0` (darkest shade) to `255` (lightest shade). This is known as the *RGB model*.

You can create a color using the following constructor:

```
public Color(int r, int g, int b);
```

in which `r`, `g`, and `b` specify a color by its red, green, and blue components. For example,

```
Color color = new Color(128, 100, 100);
```



Note

The arguments `r`, `g`, `b` are between `0` and `255`. If a value beyond this range is passed to the argument, an `IllegalArgumentException` will occur.

`IllegalArgumentException`

You can use the `setBackground(Color c)` and `setForeground(Color c)` methods defined in the `java.awt.Component` class to set a component's background and foreground colors. Here is an example of setting the background and foreground of a button:

```
JButton jbtOK = new JButton("OK");
jbtOK.setBackground(color);
jbtOK.setForeground(new Color(100, 1, 1));
```

Alternatively, you can use one of the 13 standard colors (`BLACK`, `BLUE`, `CYAN`, `DARK_GRAY`, `GRAY`, `GREEN`, `LIGHT_GRAY`, `MAGENTA`, `ORANGE`, `PINK`, `RED`, `WHITE`, and `YELLOW`) defined as constants in `java.awt.Color`. The following code, for instance, sets the foreground color of a button to red:

```
jbtOK.setForeground(Color.RED);
```

- 12.16** How do you create a color? What is wrong about creating a `Color` using `new Color(400, 200, 300)`? Which of two colors is darker, `new Color(10, 0, 0)` or `new Color(200, 0, 0)`?
- 12.17** How do you create a `Color` object with a random color?
- 12.18** How do you set a button object `jbtOK` with blue background?



MyProgrammingLab™

12.8 The Font Class

Each GUI component has the font property. Fonts are objects created from the `Font` class.

You can create a font using the `java.awt.Font` class and set fonts for the components using the `setFont` method in the `Component` class.

The constructor for `Font` is:

```
public Font(String name, int style, int size);
```

You can choose a font name from `SansSerif`, `Serif`, `Monospaced`, `Dialog`, and `DialogInput`, choose a style from `Font.PLAIN (0)`, `Font.BOLD (1)`, `Font.ITALIC (2)`, and `Font.BOLD + Font.ITALIC (3)`, and specify a font size of any positive integer. For example, the following statements create two fonts and set one font to a button.

```
Font font1 = new Font("SansSerif", Font.BOLD, 16);
Font font2 = new Font("Serif", Font.BOLD + Font.ITALIC, 12);
```

```
JButton jbtOK = new JButton("OK");
jbtOK.setFont(font1);
```



Tip

If your system supports other fonts, such as “Times New Roman,” you can use the font to create a `Font` object. To find the fonts available on your system, you need to obtain an instance of `java.awt.GraphicsEnvironment` using its static method `getLocalGraphicsEnvironment()`. `GraphicsEnvironment` is an abstract class that describes the graphics environment on a particular system. You can use its `getAllFonts()` method to obtain all the available fonts on the system and its `getAvailableFontFamilyNames()` method to obtain the names of all the available fonts. For example, the following statements print all the available font names in the system:

```
GraphicsEnvironment e =
    GraphicsEnvironment.getLocalGraphicsEnvironment();
String[] fontnames = e.getAvailableFontFamilyNames();

for (int i = 0; i < fontnames.length; i++)
    System.out.println(fontnames[i]);
```



find available fonts



12.19 How do you create a **Font** object with font name **Courier**, size **20**, and style **bold**?
12.20 How do you find all available fonts on your system?

MyProgrammingLab™



12.9 Common Features of Swing GUI Components

*GUI components have common features. They are defined in the superclasses **Component**, **Container**, and **JComponent**.*



VideoNote

Use Swing common properties

Component
 Container
 JComponent
 tool tip

So far in this chapter you have used several GUI components (e.g., **JFrame**, **Container**, **JPanel**, **JButton**, **JLabel**, and **TextField**). Many more GUI components will be introduced in this book. It is important to understand the common features of Swing GUI components. The **Component** class is the root for all GUI components and containers. All Swing GUI components (except **JFrame**, **JApplet**, and **JDialog**) are subclasses of **JComponent**, as shown in Figure 12.1. Figure 12.11 lists some frequently used methods in **Component**, **Container**, and **JComponent** for manipulating properties such as font, color, mouse cursor, size, tool tip text, and border.

A *tool tip* is text displayed on a component when you move the mouse onto the component. It is often used to describe the function of a component.

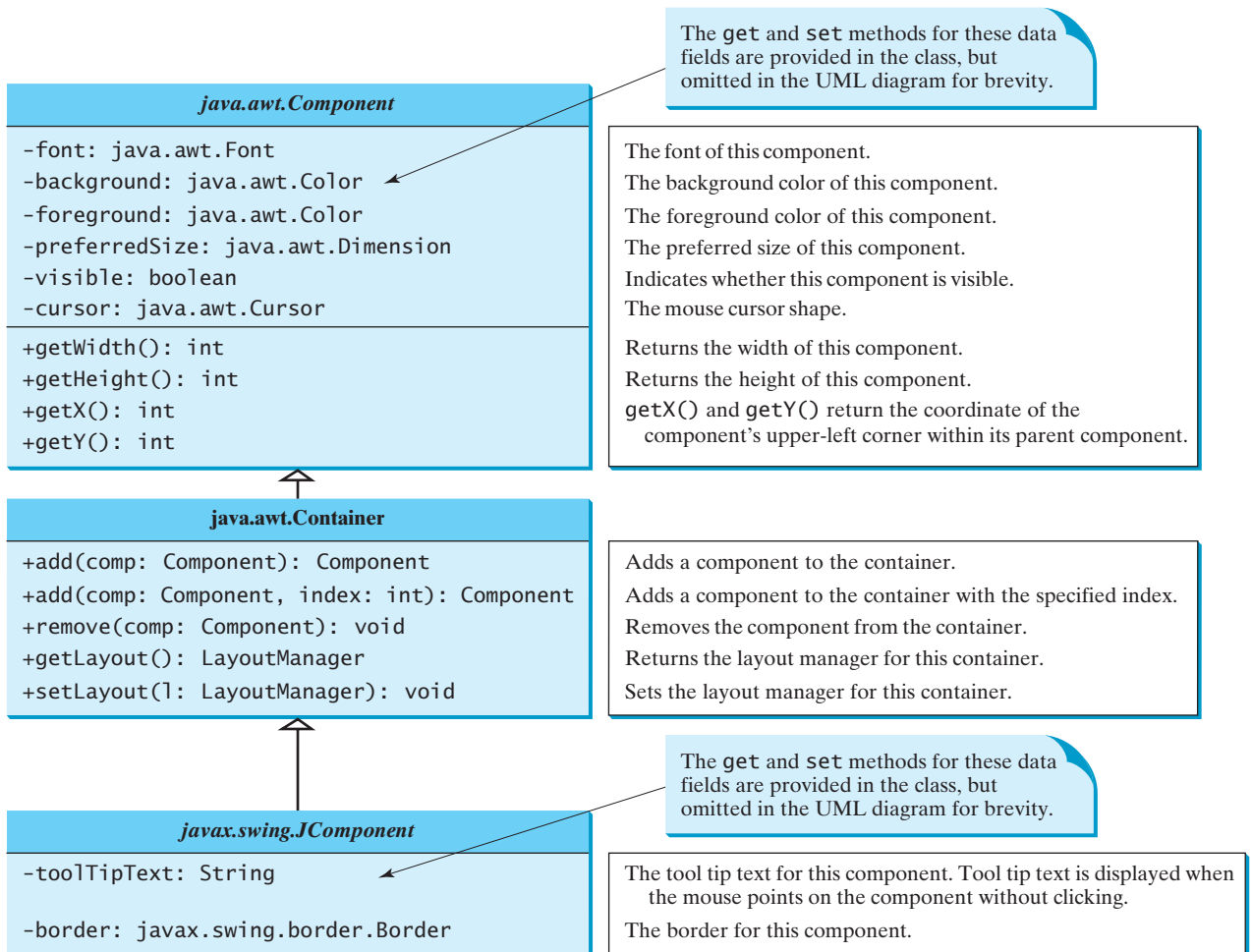


FIGURE 12.11 All the Swing GUI components inherit the public methods from **Component**, **Container**, and **JComponent**.

You can set a border for any object of the `JComponent` class. Swing has several types of borders. To create a titled border, use `new TitledBorder(String title)`. To create a line border, use `new LineBorder(Color color, int width)`, where `width` specifies the thickness of the line.

Listing 12.7 is an example to demonstrate Swing common features. The example creates a panel `p1` to hold three buttons (line 8) and a panel `p2` to hold two labels (line 26), as shown in Figure 12.12. The background of the button `jbtLeft` is set to white (line 12) and the foreground of the button `jbtCenter` is set to green (line 13). The tool tip of the button `jbtRight` is set in line 14. Titled borders are set on panels `p1` and `p2` (lines 18, 37) and line borders are set on the labels (lines 33–34).

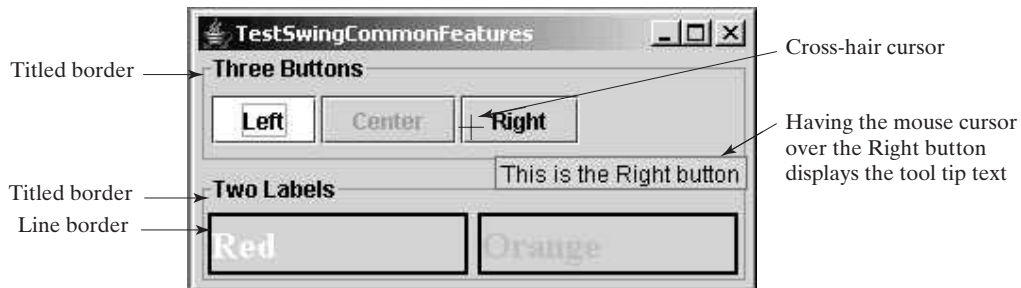


FIGURE 12.12 The font, color, border, and tool tip text are set in the message panel.

The mouse cursor is set to the cross-hair shape in `p1` (line 19). The `Cursor` class contains the constants for specifying the cursor shape such as `DEFAULT_CURSOR`, `CROSSHAIR_CURSOR`, `HAND_CURSOR`, `MOVE_CURSOR`, `TEXT_CURSOR`, and so on. A `Cursor` object for the cross-hair cursor is created using `new Cursor(Cursor.CROSSHAIR_CURSOR)` (line 19) and this cursor is set for `p1`. Note that the default mouse cursor is still used in `p2`, because the program does not explicitly set a mouse cursor for `p2`.

LISTING 12.7 TestSwingCommonFeatures.java

```

1  import java.awt.*;
2  import javax.swing.*;
3  import javax.swing.border.*;
4
5  public class TestSwingCommonFeatures extends JFrame {
6      public TestSwingCommonFeatures() {
7          // Create a panel to group three buttons
8          JPanel p1 = new JPanel(new FlowLayout(FlowLayout.LEFT, 2, 2));
9          JButton jbtLeft = new JButton("Left");
10         JButton jbtCenter = new JButton("Center");
11         JButton jbtRight = new JButton("Right");
12         jbtLeft.setBackground(Color.WHITE);           set background
13         jbtCenter.setForeground(Color.GREEN);         set foreground
14         jbtRight.setToolTipText("This is the Right button");  set tool tip text
15         p1.add(jbtLeft);
16         p1.add(jbtCenter);
17         p1.add(jbtRight);
18         p1.setBorder(new TitledBorder("Three Buttons"));  set titled border
19         p1.setCursor(new Cursor(Cursor.CROSSHAIR_CURSOR));  set mouse cursor
20
21         // Create a font and a line border
22         Font largeFont = new Font("TimesRoman", Font.BOLD, 20);  create a font
23         Border lineBorder = new LineBorder(Color.BLACK, 2);  create a border

```

```

24
25 // Create a panel to group two labels
26 JPanel p2 = new JPanel(new GridLayout(1, 2, 5, 5));
27 JLabel jlblRed = new JLabel("Red");
28 JLabel jlblOrange = new JLabel("Orange");
set foreground 29 jlblRed.setForeground(Color.RED);
30 jlblOrange.setForeground(Color.ORANGE);
set font 31 jlblRed.setFont(largeFont);
32 jlblOrange.setFont(largeFont);
set line border 33 jlblRed.setBorder(lineBorder);
34 jlblOrange.setBorder(lineBorder);
35 p2.add(jlblRed);
36 p2.add(jlblOrange);
set titled border 37 p2.setBorder(new TitledBorder("Two Labels"));
38
39 // Add two panels to the frame
40 setLayout(new GridLayout(2, 1, 5, 5));
41 add(p1);
42 add(p2);
43 }
44
45 public static void main(String[] args) {
46 // Create a frame and set its properties
47 JFrame frame = new TestSwingCommonFeatures();
48 frame.setTitle("TestSwingCommonFeatures");
49 frame.setSize(300, 150);
50 frame.setLocationRelativeTo(null); // Center the frame
51 frame.setDefaultCloseOperation(JFrame.EXIT_ON_CLOSE);
52 frame.setVisible(true);
53 }
54 }

```

property default values

**Note**

The same property may have different default values in different components. For example, the `visible` property in `JFrame` is `false` by default, but it is `true` in every instance of `JComponent` (e.g., `JButton` and `JLabel`) by default. To display a `JFrame`, you have to invoke `setVisible(true)` to set the `visible` property `true`, but you don't have to set this property for a `JButton` or a `JLabel`, because it is already `true`. To make a `JButton` or a `JLabel` invisible, you can invoke `setVisible(false)`. Please run the program and see the effect after inserting the following two statements in line 38:

```

jbtLeft.setVisible(false);
jlblRed.setVisible(false);

```



12.21 How do you set background color, foreground color, font, and tool tip text on a Swing GUI component?

MyProgrammingLab™

12.22 Why is the tool tip text not displayed in the following code?

```

1 import javax.swing.*;
2
3 public class Test extends JFrame {
4     private JButton jbtOK = new JButton("OK");
5
6     public static void main(String[] args) {
7         // Create a frame and set its properties
8         JFrame frame = new Test();
9         frame.setTitle("Logic Error");
10        frame.setSize(200, 100);
11        frame.setDefaultCloseOperation(JFrame.EXIT_ON_CLOSE);

```

```

12     frame.setVisible(true);
13 }
14
15 public Test() {
16     jbtOK.setToolTipText("This is a button");
17     add(new JButton("OK"));
18 }
19 }

```

12.23 Show the output of the following code:

```

import javax.swing.*;

public class Test {
    public static void main(String[] args) {
        JButton jbtOK = new JButton("OK");
        System.out.println(jbtOK.isVisible());

        JFrame frame = new JFrame();
        System.out.println(frame.isVisible());
    }
}

```

12.24 What happens if you add a button to a container several times, as shown below? Does it cause syntax errors? Does it cause runtime errors?

```

JButton jbt = new JButton();
JPanel panel = new JPanel();
panel.add(jbt);
panel.add(jbt);
panel.add(jbt);

```

12.10 Image Icons

*Image icons can be displayed in many GUI components. Image icons are objects created using the **ImageIcon** class.*



An icon is a fixed-size picture; typically it is small and used to decorate components. Images are normally stored in image files. Java currently supports three image formats: GIF (Graphics Interchange Format), JPEG (Joint Photographic Experts Group), and PNG (Portable Network Graphics). The image file names for these types end with **.gif**, **.jpg**, and **.png**, respectively. If you have a bitmap file or image files in other formats, you can use image-processing utilities to convert them into the GIF, JPEG, or PNG format for use in Java.

To display an image icon, first create an **ImageIcon** object using **new javax.swing.ImageIcon(filename)**. For example, the following statement creates an icon from an image file **us.gif** in the **image** directory under the current class path:

```
ImageIcon icon = new ImageIcon("image/us.gif");
```

image/us.gif is located in **c:\book\image\us.gif**. The back slash (****) is the Windows file path notation. In UNIX, the forward slash (**/**) should be used. In Java, the forward slash (**/**) is used to denote a relative file path under the Java classpath (e.g., **image/us.gif**, as in this example).

image-file format

create ImageIcon

file path character



Tip

File names are not case sensitive in Windows but are case sensitive in UNIX. To enable your programs to run on all platforms, name all the image files consistently, using lowercase.

naming files consistently

An image icon can be displayed in a label or a button using `new JLabel(imageIcon)` or `new JButton(imageIcon)`. Listing 12.8 demonstrates displaying icons in labels and buttons. The example creates two labels and two buttons with icons, as shown in Figure 12.13.

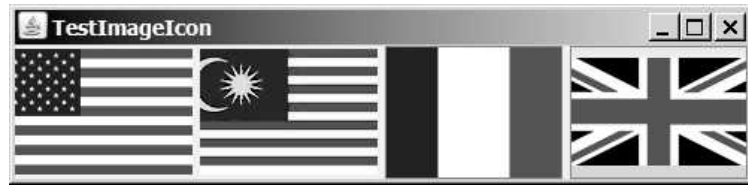


FIGURE 12.13 The image icons are displayed in labels and buttons.

LISTING 12.8 TestImageIcon.java

```

1  import javax.swing.*;
2  import java.awt.*;
3
4  public class TestImageIcon extends JFrame {
5      private ImageIcon usIcon = new ImageIcon("image/us.gif");
6      private ImageIcon myIcon = new ImageIcon("image/my.jpg");
7      private ImageIcon frIcon = new ImageIcon("image/fr.gif");
8      private ImageIcon ukIcon = new ImageIcon("image/uk.gif");
9
10     public TestImageIcon() {
11         setLayout(new GridLayout(1, 4, 5, 5));
12         add(new JLabel(usIcon));
13         add(new JLabel(myIcon));
14         add(new JButton(frIcon));
15         add(new JButton(ukIcon));
16     }
17
18     /** Main method */
19     public static void main(String[] args) {
20         TestImageIcon frame = new TestImageIcon();
21         frame.setTitle("TestImageIcon");
22         frame.setSize(200, 200);
23         frame.setLocationRelativeTo(null); // Center the frame
24         frame.setDefaultCloseOperation(JFrame.EXIT_ON_CLOSE);
25         frame.setVisible(true);
26     }
27 }

```

create image icons

a label with image

a button with image

sharing borders and icons



Note

Borders and icons can be shared. Thus, you can create a border or icon and use it to set the `border` or `icon` property for any GUI component. For example, the following statements set a border `b` for the panels `p1` and `p2`:

```
p1.setBorder(b);
p2.setBorder(b);
```

The following statements set an icon in the buttons `jbt1` and `jbt2`:

```
jbt1.setIcon(icon);
jbt2.setIcon(icon);
```

**Tip**

A splash screen is an image that is displayed while the application is starting up. If your program takes a long time to load, you may display a splash screen to alert the user. For example, the following command:

```
java -splash:image/us.gif TestImageIcon
```

displays an image while the program `TestImageIcon` is being loaded.

splash screen

12.25 How do you create an `ImageIcon` from the file `image/us.gif` in the class directory?

12.26 Will the following code display three buttons? Will the buttons display the same icon?

```
1  import javax.swing.*;
2  import java.awt.*;
3
4  public class Test extends JFrame {
5      public static void main(String[] args) {
6          // Create a frame and set its properties
7          JFrame frame = new Test();
8          frame.setTitle("ButtonIcons");
9          frame.setSize(200, 100);
10         frame.setDefaultCloseOperation(JFrame.EXIT_ON_CLOSE);
11         frame.setVisible(true);
12     }
13
14     public Test() {
15         ImageIcon usIcon = new ImageIcon("image/us.gif");
16         JButton jbt1 = new JButton(usIcon);
17         JButton jbt2 = new JButton(usIcon);
18
19         JPanel p1 = new JPanel();
20         p1.add(jbt1);
21
22         JPanel p2 = new JPanel();
23         p2.add(jbt2);
24
25         JPanel p3 = new JPanel();
26         p2.add(jbt1);
27
28         add(p1, BorderLayout.NORTH);
29         add(p2, BorderLayout.SOUTH);
30         add(p3, BorderLayout.CENTER);
31     }
32 }
```



MyProgrammingLab™

12.27 Can a border or an icon be shared by GUI components?

12.11 JButton

To create a push button, use the `JButton` class.

We have used `JButton` in the examples to demonstrate the basics of GUI programming. This section will introduce more features of `JButton`. The following sections will introduce GUI components `JCheckBox`, `JRadioButton`, `JLabel`, `JTextField`, and `JPasswordField`. More GUI components such as `JTextArea`, `JComboBox`, `JList`, `JScrollbar`, and `JSlider` will be introduced in Chapter 17. The relationship of these classes is pictured in Figure 12.14.



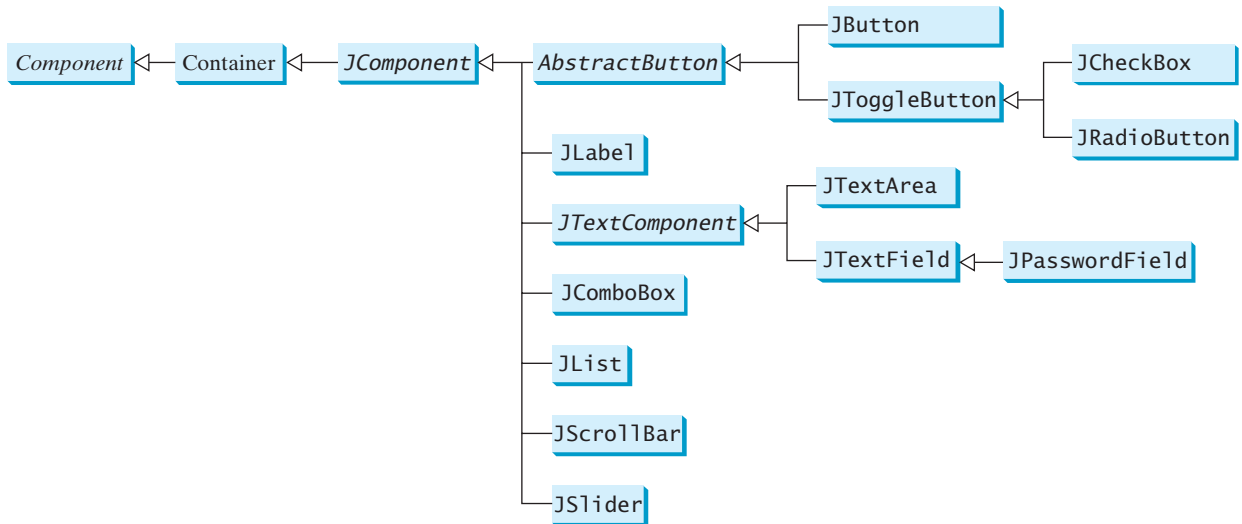


FIGURE 12.14 These Swing GUI components are frequently used to create user interfaces.

naming convention for components



Note

Throughout this book, the prefixes **jbt**, **jchk**, **jrb**, **jlbl**, **jtf**, **jpj**, **jta**, **jcb**, **jlst**, **jscb**, and **jsld** are used to name reference variables for **JButton**, **JCheckBox**, **JRadioButton**, **JLabel**, **JTextField**, **JPasswordField**, **JTextArea**, **JComboBox**, **JList**, **JScrollBar**, and **JSlider**.

A *button* is a component that triggers an action when clicked. Swing provides regular buttons, toggle buttons, check box buttons, and radio buttons. The common features of these buttons are defined in **javax.swing.AbstractButton**, as shown in Figure 12.15.

AbstractButton

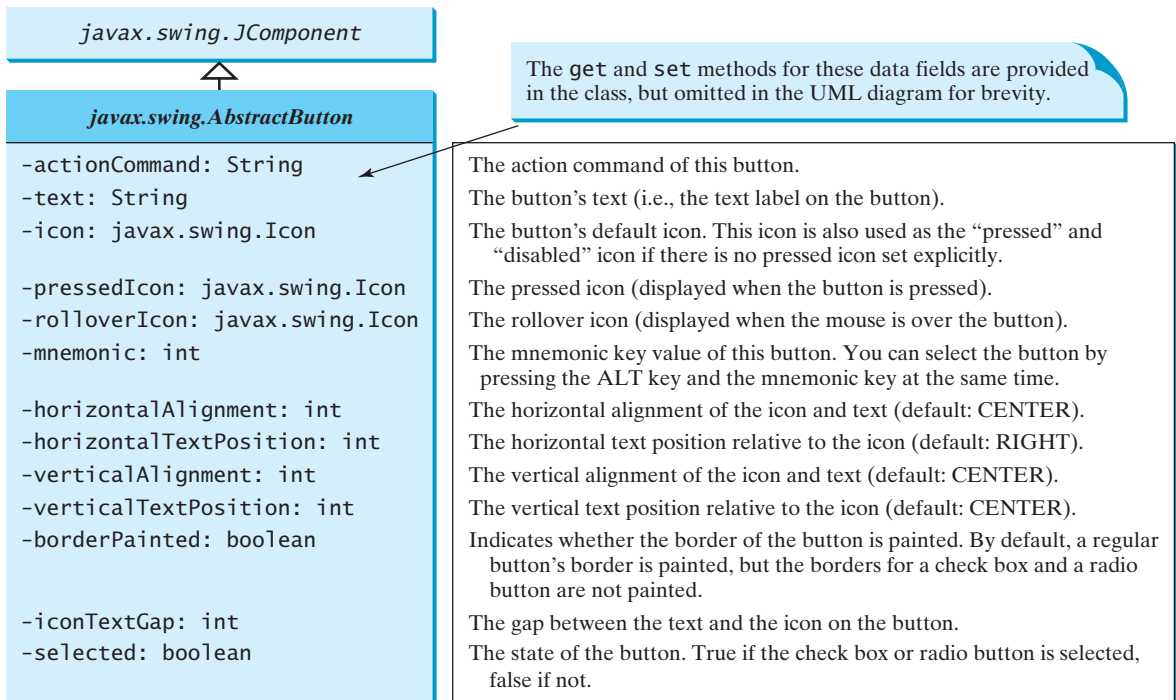


FIGURE 12.15 **AbstractButton** defines common features of different types of buttons.

JButton inherits **AbstractButton** and provides several constructors to create buttons, as shown in Figure 12.16.

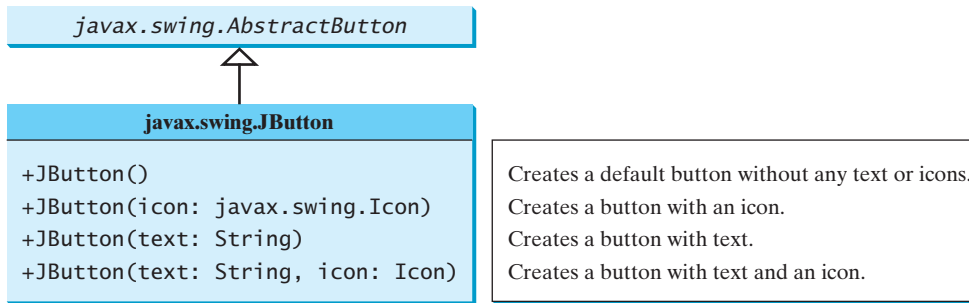


FIGURE 12.16 **JButton** defines a regular push button.

12.11.1 Icons, Pressed Icons, and Rollover Icons

A button has a default icon, a pressed icon, and a rollover icon. Normally you use the default icon, because the other icons are for special effects. A pressed icon is displayed when a button is pressed, and a rollover icon is displayed when the mouse is over the button but not pressed. For example, Listing 12.9 displays the U.S. flag as a regular icon, the Canadian flag as a pressed icon, and the British flag as a rollover icon, as shown in Figure 12.17.

LISTING 12.9 TestButtonIcons.java

```

1 import javax.swing.*;
2
3 public class TestButtonIcons extends JFrame {
4     public static void main(String[] args) {
5         // Create a frame and set its properties
6         JFrame frame = new TestButtonIcons();
7         frame.setTitle("ButtonIcons");
8         frame.setSize(200, 100);
9         frame.setLocationRelativeTo(null); // Center the frame
10        frame.setDefaultCloseOperation(JFrame.EXIT_ON_CLOSE);
11        frame.setVisible(true);
12    }
13
14    public TestButtonIcons() {
15        ImageIcon usIcon = new ImageIcon("image/usIcon.gif");
16        ImageIcon caIcon = new ImageIcon("image/caIcon.gif");
17        ImageIcon ukIcon = new ImageIcon("image/ukIcon.gif");
18
19        JButton jbt = new JButton("Click it", usIcon);
20        jbt.setPressedIcon(caIcon);
21        jbt.setRolloverIcon(ukIcon);
22
23        add(jbt);
24    }
25 }

```

create icons
 regular icon
 pressed icon
 rollover icon
 add a button



FIGURE 12.17 A button can have several types of icons.

12.11.2 Alignments

horizontal alignment

Horizontal alignment specifies how the icon and text are placed horizontally on a button. You can set the horizontal alignment using `setHorizontalAlignment(int)` with one of the five constants `LEADING`, `LEFT`, `CENTER`, `RIGHT`, or `TRAILING`, as shown in Figure 12.18. At present, `LEADING` and `LEFT` are the same, and `TRAILING` and `RIGHT` are the same. Future implementation may distinguish them. The default horizontal alignment is `AbstractButton.CENTER`.

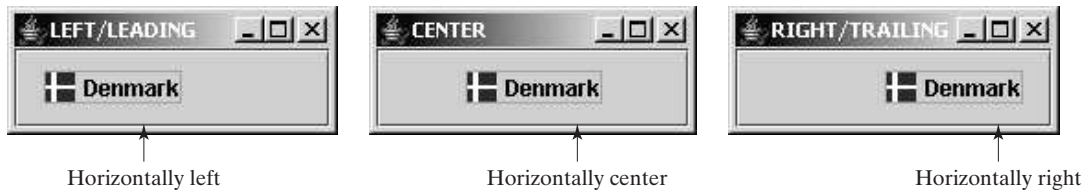


FIGURE 12.18 You can specify how the icon and text are placed on a button horizontally.

vertical alignment

Vertical alignment specifies how the icon and text are placed vertically on a button. You can set the vertical alignment using `setVerticalAlignment(int)` with one of the three constants `TOP`, `CENTER`, or `BOTTOM`, as shown in Figure 12.19. The default vertical alignment is `AbstractButton.CENTER`.

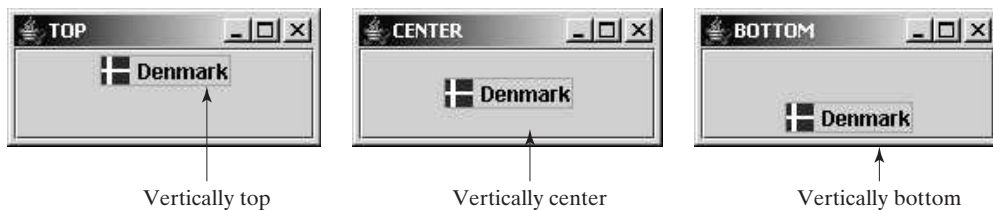


FIGURE 12.19 You can specify how the icon and text are placed on a button vertically.

12.11.3 Text Positions

horizontal text position

Horizontal text position specifies the horizontal position of the text relative to the icon. You can set the horizontal text position using `setHorizontalTextPosition(int)` with one of the five constants `LEADING`, `LEFT`, `CENTER`, `RIGHT`, or `TRAILING`, as shown in Figure 12.20. At present, `LEADING` and `LEFT` are the same, and `TRAILING` and `RIGHT` are the same. Future implementation may distinguish them. The default horizontal text position is `AbstractButton.RIGHT`.

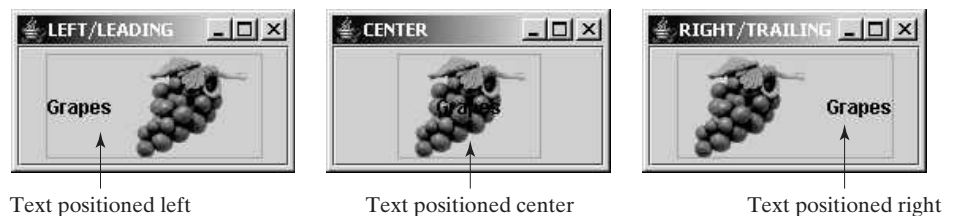


FIGURE 12.20 You can specify the horizontal position of the text relative to the icon.

vertical text position

Vertical text position specifies the vertical position of the text relative to the icon. You can set the vertical text position using `setVerticalTextPosition(int)` with one of the three

constants `TOP`, `CENTER`, or `BOTTOM`, as shown in Figure 12.21. The default vertical text position is `AbstractButton.CENTER`.

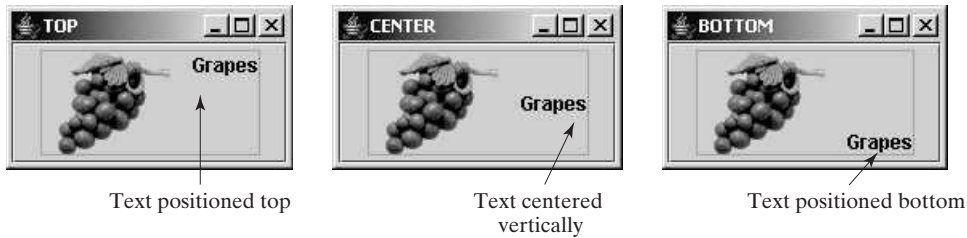


FIGURE 12.21 You can specify the vertical position of the text relative to the icon.

- 12.28** How do you create a button with the text OK? How do you change text on a button? How do you set an icon, a pressed icon, and a rollover icon in a button?
- 12.29** Given a `JButton` object `jbtOK`, write statements to set the button's foreground to `red`, background to `yellow`, mnemonic to `K`, tool tip text to `Click OK to proceed`, horizontal alignment to `RIGHT`, vertical alignment to `BOTTOM`, horizontal text position to `LEFT`, vertical text position to `TOP`, and icon text gap to `5`.
- 12.30** List at least five properties defined in the `AbstractButton` class.



MyProgrammingLab™

12.12 JCheckBox

To create a check box button, use the `JCheckBox` class.

A *toggle button* is a two-state button like a light switch. `JToggleButton` inherits `AbstractButton` and implements a toggle button. Often `JToggleButton`'s subclasses `JCheckBox` and `JRadioButton` are used to enable the user to toggle a choice on or off. This section introduces `JCheckBox`. `JRadioButton` will be introduced in the next section.

`JCheckBox` inherits all the properties from `AbstractButton`, such as `text`, `icon`, `mnemonic`, `verticalAlignment`, `horizontalAlignment`, `horizontalTextPosition`, `verticalTextPosition`, and `selected`, and provides several constructors to create check boxes, as shown in Figure 12.22.



toggle button

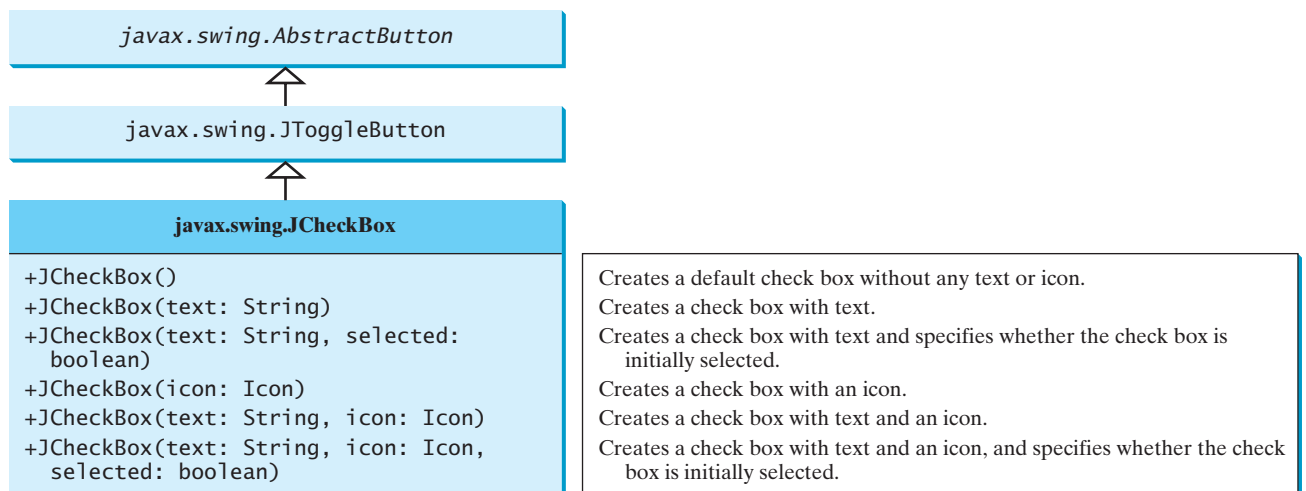


FIGURE 12.22 `JCheckBox` defines a check box button.

Here is an example for creating a check box with the text *Student*. Its foreground is **red**, the background is **white**, its mnemonic key is **S**, and it is initially selected.

```
JCheckBox jchk = new JCheckBox("Student", true);
jchk.setForeground(Color.RED);
jchk.setBackground(Color.WHITE);
jchk.setMnemonic('S');
```



mnemonics

The button can also be accessed by using the keyboard mnemonics. Pressing **Alt+S** is equivalent to clicking the check box.

isSelected?

To see if a check box is selected, use the `isSelected()` method.



12.31 How do you create a check box? How do you create a check box with the box checked initially? How do you determine whether a check box is selected?

MyProgrammingLab™

12.13 JRadioButton



To create a radio button, use the `JRadioButton` class.

Radio buttons, also known as *option buttons*, enable you to choose a single item from a group of choices. In appearance radio buttons resemble check boxes, but check boxes display a square that is either checked or blank, whereas radio buttons display a circle that is either filled (if selected) or blank (if not selected).

`JRadioButton` inherits `AbstractButton` and provides several constructors to create radio buttons, as shown in Figure 12.23. These constructors are similar to the constructors for `JCheckBox`.

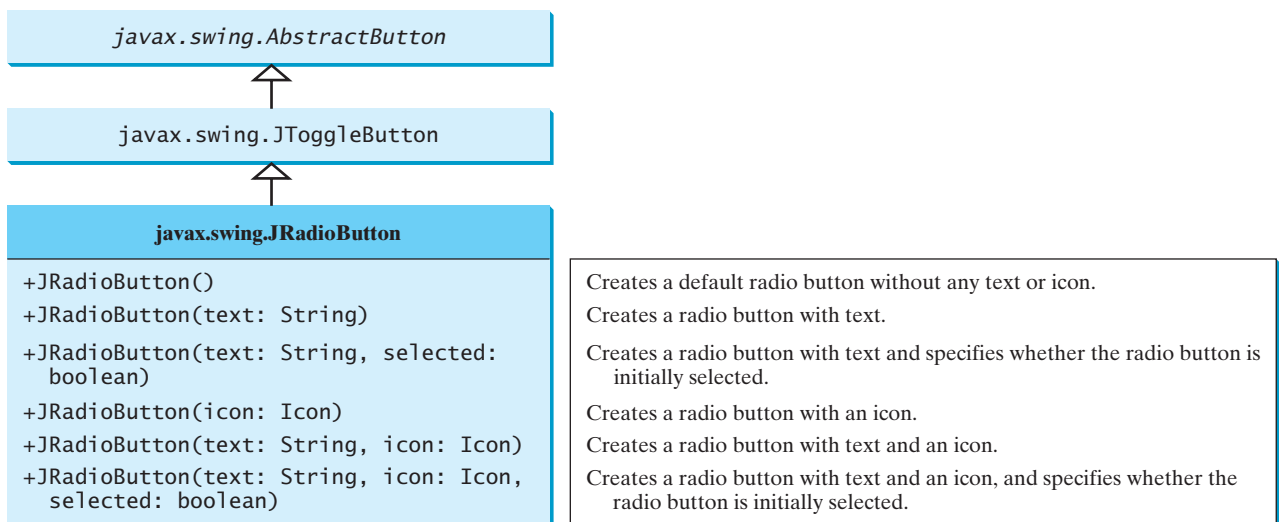


FIGURE 12.23 `JRadioButton` defines a radio button.

Here is an example for creating a radio button with the text *Student*. The code specifies **red** foreground, **white** background, mnemonic key **S**, and initially selected.

```
JRadioButton jrb = new JRadioButton("Student", true);
jrb.setForeground(Color.RED);
jrb.setBackground(Color.WHITE);
jrb.setMnemonic('S');
```



To group radio buttons, you need to create an instance of `java.swing.ButtonGroup` and use the `add` method to add them to it, as follows:

```
ButtonGroup group = new ButtonGroup();
group.add(jrb1);
group.add(jrb2);
```

This code creates a radio-button group for the radio buttons `jrb1` and `jrb2` so that they are selected mutually exclusively. Without grouping, `jrb1` and `jrb2` would be independent.



Note

`ButtonGroup` is not a subclass of `java.awt.Component`, so a `ButtonGroup` object cannot be added to a container.

To see if a radio button is selected, use the `isSelected()` method.

GUI helper class

12.32 How do you create a radio button? How do you create a radio button with the button selected initially? How do you group radio buttons together? How do you determine whether a radio button is selected?



MyProgrammingLab™

12.14 Labels

To create a label, use the `JLabel` class.

A *label* is a display area for a short text, an image, or both. It is often used to label other components (usually text fields). Figure 12.24 lists the constructors and methods in the `JLabel` class.

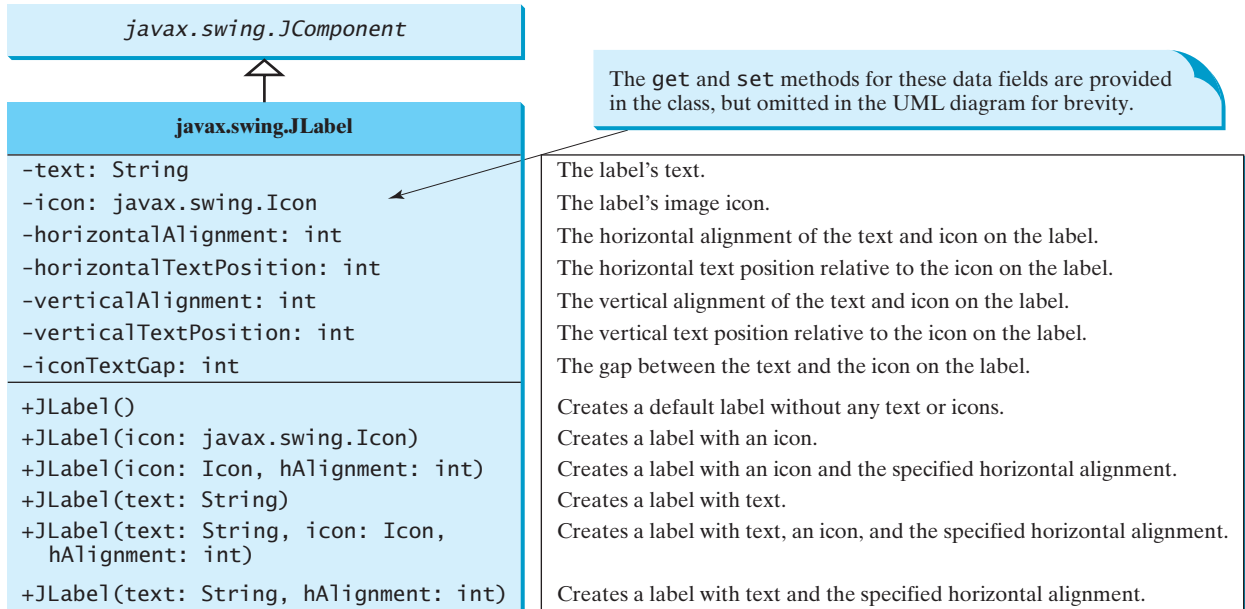


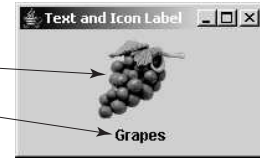
FIGURE 12.24 `JLabel` displays text or an icon, or both.

`JLabel` inherits all the properties from `JComponent` and has many properties similar to the ones in `JButton`, such as `text`, `icon`, `horizontalAlignment`, `verticalAlignment`, `horizontalTextPosition`, `verticalTextPosition`, and `iconTextGap`. For example, the following code displays a label with text and an icon:

```
// Create an image icon from an image file
ImageIcon icon = new ImageIcon("image/grapes.gif");

// Create a label with a text, an icon,
// with centered horizontal alignment
JLabel jlbl = new JLabel("Grapes", icon, JLabel.CENTER);

//Set label's text alignment and gap between text and icon
jlbl.setHorizontalTextPosition(JLabel.CENTER);
jlbl.setVerticalTextPosition(JLabel.BOTTOM);
jlbl.setIconTextGap(5);
```



12.33 How do you create a label named **Address**? How do you change the name on a label? How do you set an icon in a label?

MyProgrammingLab™

12.34 Given a **JLabel** object **jlblMap**, write statements to set the label's foreground to **red**, background to **yellow**, mnemonic to **M**, tool tip text to **Map image**, horizontal alignment to **RIGHT**, vertical alignment to **BOTTOM**, horizontal text position to **LEFT**, vertical text position to **TOP**, and icon text gap to **5**.

12.15 Text Fields



To create a text field, use the **JTextField** class.

A text field can be used to enter or display a string. **JTextField** is a subclass of **JTextComponent**. Figure 12.25 lists the constructors and methods in **JTextField**.

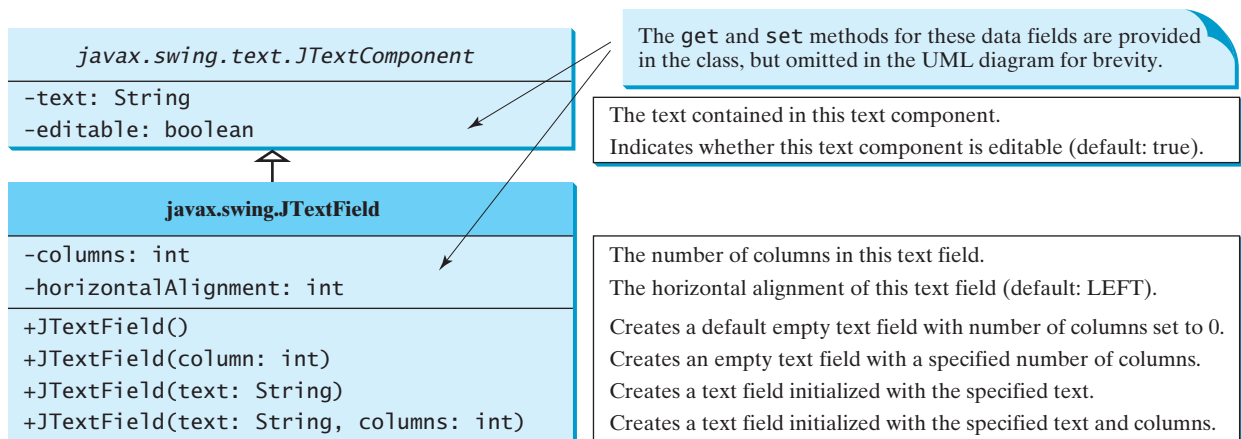


FIGURE 12.25 **JTextField** enables you to enter or display a string.

JTextField inherits **JTextComponent**, which inherits **JComponent**. Here is an example of creating a text field with red foreground color and right horizontal alignment:

```
JTextField jtfMessage = new JTextField("T-Storm");
jtfMessage.setForeground(Color.RED);
jtfMessage.setHorizontalAlignment(JTextField.RIGHT);
```

To set new text in a text field, use the **setText(newText)** method. To get the text from a text field, use the **getText()** method.

**Note**

If a text field is used for entering a password, use `JPasswordField` to replace `JTextField`. `JPasswordField` extends `JTextField` and hides the input text with echo characters (e.g., `*****`). By default, the echo character is `*`. You can specify a new echo character using the `setEchoChar(char)` method.

JPasswordField

- 12.35** How do you create a text field with 10 columns and the default text `Welcome to Java`? How do you write the code to check whether a text field is empty?
- 12.36** How do you create text field for entering passwords?



MyProgrammingLab™

KEY TERMS

AWT	446	layout manager	451
component class	446	lightweight component	446
container class	446	Swing components	446
heavyweight component	446	splash screen	467
helper class	446	top-level container	447

CHAPTER SUMMARY

- Every container has a *layout manager* that is used to position and place components in the container in the desired locations. Three simple and frequently used layout managers are `FlowLayout`, `GridLayout`, and `BorderLayout`.
- You can use a `JPanel` as a subcontainer to group components to achieve a desired layout.
- Use the `add` method to place components in a `JFrame` or a `JPanel`. By default, the frame's layout is `BorderLayout`, and the `JPanel`'s layout is `FlowLayout`.
- Colors are made of red, green, and blue components, each represented by an unsigned byte value that describes its intensity, ranging from 0 (darkest shade) to 255 (lightest shade). This is known as the *RGB model*.
- To create a `Color` object, use `new Color(r, g, b)`, in which `r`, `g`, and `b` specify a color by its red, green, and blue components. Alternatively, you can use one of the 13 standard colors (`BLACK`, `BLUE`, `CYAN`, `DARK_GRAY`, `GRAY`, `GREEN`, `LIGHT_GRAY`, `MAGENTA`, `ORANGE`, `PINK`, `RED`, `WHITE`, `YELLOW`) defined as constants in `java.awt.Color`.
- Every *Swing* GUI component is a subclass of `javax.swing.JComponent`, and `JComponent` is a subclass of `java.awt.Component`. The properties `font`, `background`, `foreground`, `height`, `width`, and `preferredSize` in `Component` are inherited in these subclasses, as are `toolTipText` and `border` in `JComponent`.
- You can use borders on any Swing components. You can create an image icon using the `ImageIcon` class and display it in a label and a button. Icons and borders can be shared.
- You can display a text and icon on buttons (`JButton`, `JCheckBox`, `JRadioButton`) and labels (`JLabel`).
- You can specify the horizontal and vertical text alignment in `JButton`, `JCheckBox`, `JRadioButton`, and `JLabel`, and the horizontal text alignment in `JTextField`.

10. You can specify the horizontal and vertical text position relative to the icon in [JButton](#), [JCheckBox](#), [JRadioButton](#), and [JLabel](#).

TEST QUESTIONS

Do the test questions for this chapter online at www.cs.armstrong.edu/liang/intro9e/test.html.

MyProgrammingLab™

PROGRAMMING EXERCISES



Note

The image icons used in the exercises can be obtained from www.cs.armstrong.edu/liang/intro9e/book.zip under the image folder.

download image files

Sections 12.2–12.6

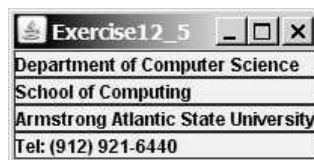
- 12.1 (Use the [FlowLayout](#) manager) Write a program that meets the following requirements (see Figure 12.26):

- Create a frame and set its layout to [FlowLayout](#).
- Create two panels and add them to the frame.
- Each panel contains three buttons. The panel uses [FlowLayout](#).

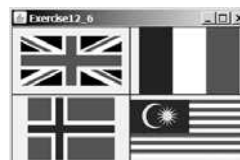


FIGURE 12.26 Exercise 12.1 places the first three buttons in one panel and the other three buttons in another panel.

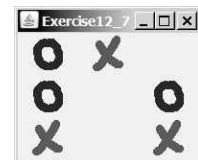
- 12.2 (Use the [BorderLayout](#) manager) Rewrite the preceding program to create the same user interface, but instead of using [FlowLayout](#) for the frame, use [BorderLayout](#). Place one panel in the south of the frame and the other in the center.
- 12.3 (Use the [GridLayout](#) manager) Rewrite Programming Exercise 12.1 to add six buttons into a frame. Use a [GridLayout](#) of two rows and three columns for the frame.
- 12.4 (Use [JPanel](#) to group buttons) Rewrite Programming Exercise 12.1 to create the same user interface. Instead of creating buttons and panels separately, define a class that extends the [JPanel](#) class. Place three buttons in your panel class, and create two panels from the user-defined panel class.
- 12.5 (Display labels) Write a program that displays four lines of text in four labels, as shown in Figure 12.27a. Add a line border around each label.



(a)



(b)



(c)

FIGURE 12.27 (a) Exercise 12.5 displays four labels. (b) Exercise 12.6 displays four icons. (c) Exercise 12.7 displays a tic-tac-toe board with image icons in labels.

Sections 12.7–12.15

- 12.6** (*Display icons*) Write a program that displays four icons in four labels, as shown in Figure 12.27b. Add a line border around each label.
- **12.7** (*Game: display a tic-tac-toe board*) Display a frame that contains nine labels. A label may display an image icon for X or an image icon for O, as shown in Figure 12.27c. What to display is randomly decided. Use the `Math.random()` method to generate an integer `0` or `1`, which corresponds to displaying an X or O image icon. These images are in the files `x.gif` and `o.gif`.
- *12.8** (*Swing common features*) Display a frame that contains six labels. Set the background of the labels to white. Set the foreground of the labels to black, blue, cyan, green, magenta, and orange, respectively, as shown in Figure 12.28a. Set the border of each label to a line border with the color yellow. Set the font of each label to Times Roman, bold, and 20 pixels. Set the text and tool tip text of each label to the name of its foreground color.

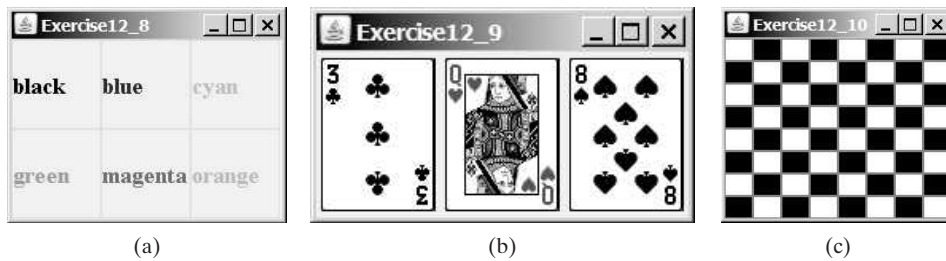



FIGURE 12.28 (a) Six labels are placed in the frame. (b) Three cards are randomly selected. (c) A checkerboard is displayed using buttons.

- *12.9** (*Game: display three cards*) Display a frame that contains three labels. Each label displays a card, as shown in Figure 12.28b. The card image files are named `1.png`, `2.png`, . . . , `54.png` (including jokers) and stored in the `image/card` directory. All three cards are distinct and selected randomly.
- *12.10** (*Game: display a checkerboard*) Write a program that displays a checkerboard in which each white and black cell is a `JButton` with a background black or white, as shown in Figure 12.28c.
- *12.11** (*Game: display four cards*) Use the same cards from Exercise 12.9 to display a frame that contains four buttons. All buttons have the same icon from `backCard.png`, as shown in Figure 12.29a. The pressed icons are four cards randomly selected from the 54 cards in a deck, as shown in Figure 12.29b.

 VideoNote
Display a checkerboard

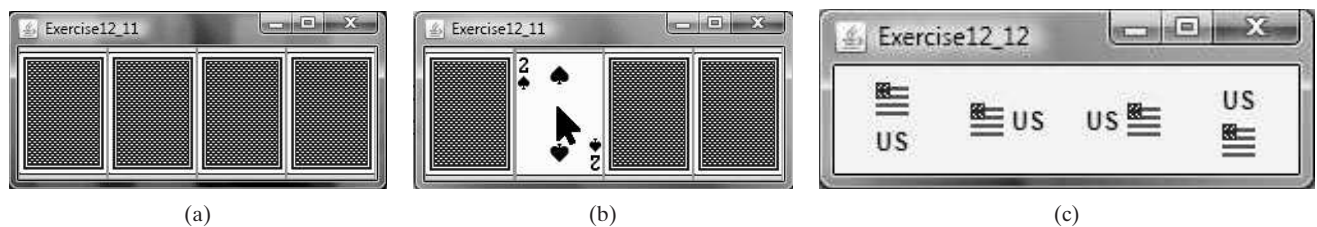


FIGURE 12.29 (a) The four buttons have the same icon. (b) Each button’s pressed icon is randomly picked from the deck. (c) The image icons and texts are displayed in four labels.

**VideoNote**

Display a random matrix

- 12.12** (*Use labels*) Write a program that displays the image icon and the text in four labels, as shown Figure 12.29c.
- 12.13** (*Display 54 cards*) Expand Exercise 12.9 to display all 54 cards in 54 labels, nine per row.
- *12.14** (*Display random 0 or 1*) Write a program that displays a 10-by-10 square matrix, as shown in Figure 12.30. Each element in the matrix is **0** or **1**, randomly generated. Display each number centered in a label.

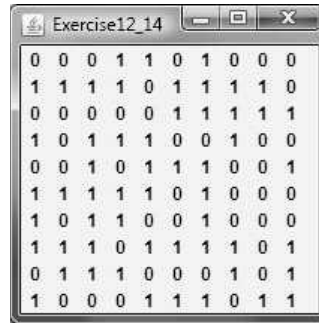


FIGURE 12.30 The program randomly generates 0s and 1s.

GRAPHICS

Objectives

- To draw graphics using the methods in the **Graphics** class (§13.2).
- To override the **paintComponent** method to draw graphics on a GUI component (§13.2).
- To use a panel as a canvas to draw graphics (§13.2).
- To draw strings, lines, rectangles, ovals, arcs, and polygons (§§13.3, 13.5–13.6).
- To obtain font properties using **FontMetrics** and to display a text centered in a panel (§13.7).
- To display an image on a GUI component (§13.10).
- To develop the reusable GUI components **FigurePanel**, **MessagePanel**, **StillClock**, and **ImageViewer** (§§13.4, 13.8, 13.9, 13.11).



13.1 Introduction



You can draw custom shapes on a GUI component.

Problem

Suppose you want to draw shapes such as a bar chart, a clock, or a stop sign, as shown in Figure 13.1. How do you do so?

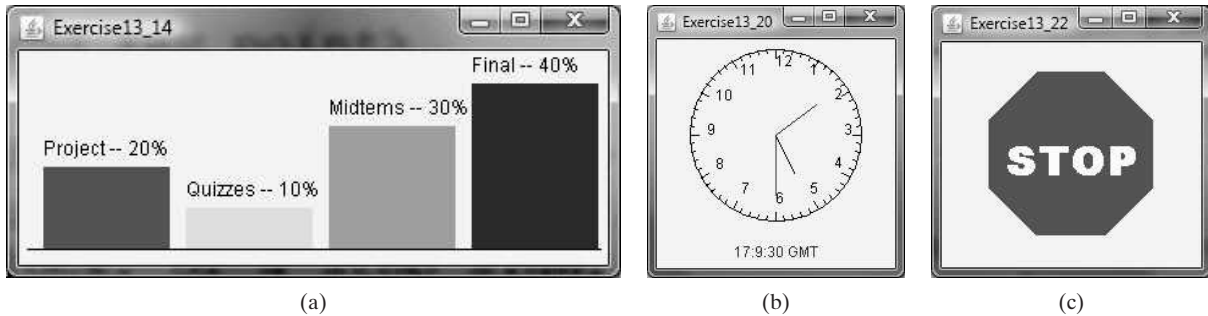


FIGURE 13.1 You can draw shapes using the drawing methods in the **Graphics** class.

This chapter describes how to use the methods in the **Graphics** class to draw strings, lines, rectangles, ovals, arcs, polygons, and images, and how to develop reusable GUI components.

13.2 The Graphics Class



*Each GUI component has a graphics context, which is an object of the **Graphics** class. The **Graphics** class contains the methods for drawing various shapes.*

The **Graphics** class provides the methods for drawing strings, lines, rectangles, ovals, arcs, polygons, and polylines, as shown in Figure 13.2.

Think of a GUI component as a piece of paper and the **Graphics** object as a pencil or paintbrush. You can apply the methods in the **Graphics** class to draw graphics on a GUI component.

To paint, you need to specify where to paint. Each component has its own coordinate system with the origin (0, 0) at the upper-left corner. The *x*-coordinate increases to the right, and the *y*-coordinate increases downward. Note that the Java coordinate system differs from the conventional coordinate system, as shown in Figure 13.3.

The **Graphics** class—an abstract class—provides a device-independent graphics interface for displaying figures and images on the screen on different platforms. Whenever a component (e.g., a button, a label, or a panel) is displayed, the JVM automatically creates a **Graphics** object for the component on the native platform and passes this object to invoke the **paintComponent** method to display the drawings.

paintComponent

The signature of the **paintComponent** method is as follows:

```
protected void paintComponent(Graphics g)
```

This method, defined in the **JComponent** class, is invoked whenever a component is first displayed or redisplayed.

To draw on a component, you need to define a class that extends **JPanel** and overrides its **paintComponent** method to specify what to draw. Listing 13.1 gives an example that draws a line and a string on a panel, as shown in Figure 13.4.

<i>java.awt.Graphics</i>	
<pre>+setColor(color: Color): void +setFont(font: Font): void +drawString(s: String, x: int, y: int): void +drawLine(x1: int, y1: int, x2: int, y2: int): void +drawRect(x: int, y: int, w: int, h: int): void +fillRect(x: int, y: int, w: int, h: int): void +drawRoundRect(x: int, y: int, w: int, h: int, aw: int, ah: int): void +fillRoundRect(x: int, y: int, w: int, h: int, aw: int, ah: int): void +draw3DRect(x: int, y: int, w: int, h: int, raised: boolean): void +fill3DRect(x: int, y: int, w: int, h: int, raised: boolean): void +drawOval(x: int, y: int, w: int, h: int): void +fillOval(x: int, y: int, w: int, h: int): void +drawArc(x: int, y: int, w: int, h: int, startAngle: int, arcAngle: int): void +fillArc(x: int, y: int, w: int, h: int, startAngle: int, arcAngle: int): void +drawPolygon(xPoints: int[], yPoints: int[], nPoints: int): void +fillPolygon(xPoints: int[], yPoints: int[], nPoints: int): void +drawPolygon(g: Polygon): void +fillPolygon(g: Polygon): void +drawPolyline(xPoints: int[], yPoints: int[], nPoints: int): void</pre>	<p>Sets a new color for subsequent drawings.</p> <p>Sets a new font for subsequent drawings.</p> <p>Draws a string starting at point (x, y).</p> <p>Draws a line from (x1, y1) to (x2, y2).</p> <p>Draws a rectangle with specified upper-left corner point at (x, y) and width w and height h.</p> <p>Draws a filled rectangle with specified upper-left corner point at (x, y) and width w and height h.</p> <p>Draws a round-cornered rectangle with specified arc width aw and arc height ah.</p> <p>Draws a filled round-cornered rectangle with specified arc width aw and arc height ah.</p> <p>Draws a 3-D rectangle raised above the surface or sunk into the surface.</p> <p>Draws a filled 3-D rectangle raised above the surface or sunk into the surface.</p> <p>Draws an oval bounded by the rectangle specified by the parameters x, y, w, and h.</p> <p>Draws a filled oval bounded by the rectangle specified by the parameters x, y, w, and h.</p> <p>Draws an arc conceived as part of an oval bounded by the rectangle specified by the parameters x, y, w, and h.</p> <p>Draws a filled arc conceived as part of an oval bounded by the rectangle specified by the parameters x, y, w, and h.</p> <p>Draws a closed polygon defined by arrays of x- and y-coordinates. Each pair of (x[i], y[i])-coordinates is a point.</p> <p>Draws a filled polygon defined by arrays of x- and y-coordinates. Each pair of (x[i], y[i])-coordinates is a point.</p> <p>Draws a closed polygon defined by a Polygon object.</p> <p>Draws a filled polygon defined by a Polygon object.</p> <p>Draws a polyline defined by arrays of x- and y-coordinates. Each pair of (x[i], y[i])-coordinates is a point.</p>

FIGURE 13.2 The Graphics class contains the methods for drawing strings and shapes.

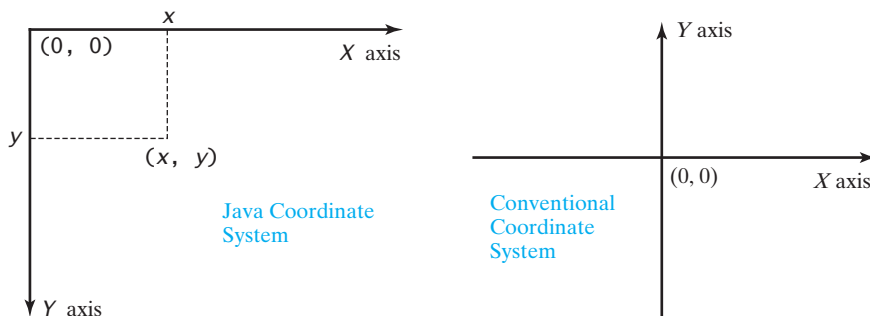


FIGURE 13.3 The Java coordinate system is measured in pixels, with (0, 0) at its upper-left corner.

LISTING 13.1 TestPaintComponent.java

```
1 import javax.swing.*;
2 import java.awt.Graphics;
3
```

```

4 public class TestPaintComponent extends JFrame {
5     public TestPaintComponent() {
6         add(new JPanel());
7     }
8
9     public static void main(String[] args) {
10        TestPaintComponent frame = new TestPaintComponent();
11        frame.setTitle("TestPaintComponent");
12        frame.setSize(200, 100);
13        frame.setLocationRelativeTo(null); // Center the frame
14        frame.setDefaultCloseOperation(JFrame.EXIT_ON_CLOSE);
15        frame.setVisible(true);
16    }
17 }
18
19 class JPanel extends JPanel {
20     @Override
21     protected void paintComponent(Graphics g) {
22         super.paintComponent(g);
23         g.drawLine(0, 0, 50, 50);
24         g.drawString("Banner", 0, 40);
25     }
26 }

```

create a panel

new panel class

override paintComponent

draw things in the superclass

draw line

draw string



FIGURE 13.4 A line and a string are drawn on a panel.

The `paintComponent` method is automatically invoked to paint graphics when the component is first displayed or whenever the component needs to be redisplayed. Invoking `super.paintComponent(g)` (line 22) invokes the `paintComponent` method defined in the superclass. This is necessary to ensure that the viewing area is cleared before a new drawing is displayed. Line 23 invokes the `drawLine` method to draw a line from `(0, 0)` to `(50, 50)`. Line 24 invokes the `drawString` method to draw the string `Banner` at location `(0, 40)`.

All the drawing methods have parameters that specify the locations of the subjects to be drawn. In Java, all measurements are made in pixels.

The JVM invokes `paintComponent` to draw things on a component. The user should never invoke `paintComponent` directly. For this reason, the protected visibility is sufficient for `paintComponent`.

Panels are invisible and are used as small containers that group components to achieve a desired layout. Another important use of `JPanel` is for drawing. You can draw things on any Swing GUI component, but normally you should use a `JPanel` as a canvas upon which to draw things. What happens if you replace `JPanel` with `JLabel` in line 19 as follows?

```
class JPanel extends JLabel {
```

extends JPanel?

The program will work, but it is not preferred, because `JLabel` is designed for creating a label, not for drawing. For consistency, this book will define a canvas class by subclassing `JPanel`.



Tip

Some textbooks define a canvas class by subclassing `JComponent`. The problem with doing that is if you want to set a background in the canvas, you have to write the code to paint the background color. A simple `setBackground(Color color)` method will not set a background color in a `JComponent`.

extends `JComponent`?



MyProgrammingLab™

- 13.1 Suppose that you want to draw a new message below an existing message. Should the x-coordinate, y-coordinate, or both increase or decrease?
- 13.2 How is a `Graphics` object created?
- 13.3 How is the `paintComponent` method invoked? How can a program invoke this method?
- 13.4 Why is the `paintComponent` method **protected**? What happens if you change it to **public** or **private** in a subclass? Why is `super.paintComponent(g)` invoked in line 22 in Listing 13.1?
- 13.5 Can you draw things on any Swing GUI component? Why should you use a panel as a canvas for drawings rather than a label or a button?

13.3 Drawing Strings, Lines, Rectangles, and Ovals

You can draw strings, lines, rectangles, and ovals in a graphics context.



The `drawString(String s, int x, int y)` method draws a string starting at the point `(x, y)`, as shown in Figure 13.5a.

The `drawLine(int x1, int y1, int x2, int y2)` method draws a straight line from point `(x1, y1)` to point `(x2, y2)`, as shown in Figure 13.5b.

drawString

drawLine

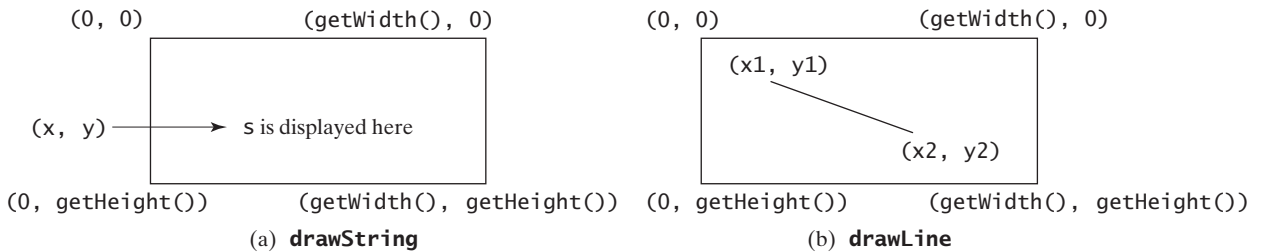


FIGURE 13.5 (a) The `drawString(s, x, y)` method draws a string starting at `(x, y)`. (b) The `drawLine(x1, y1, x2, y2)` method draws a line between two specified points.

Java provides six methods for drawing the outline of rectangles or rectangles filled with color. You can draw or fill plain rectangles, round-cornered rectangles, or three-dimensional rectangles.

The `drawRect(int x, int y, int w, int h)` method draws a plain rectangle, and the `fillRect(int x, int y, int w, int h)` method draws a filled rectangle. The parameters `x` and `y` represent the upper-left corner of the rectangle, and `w` and `h` are its width and height (see Figure 13.6).

drawRect

fillRect

The `drawRoundRect(int x, int y, int w, int h, int aw, int ah)` method draws a round-cornered rectangle, and the `fillRoundRect(int x, int y, int w, int h, int aw, int ah)` method draws a filled round-cornered rectangle. Parameters `x, y, w,` and `h` are the same as in the `drawRect` method, parameter `aw` is the horizontal diameter of the arcs at the corner, and `ah` is the vertical diameter of the arcs at the corner (see Figure 13.7a).

drawRoundRect

fillRoundRect

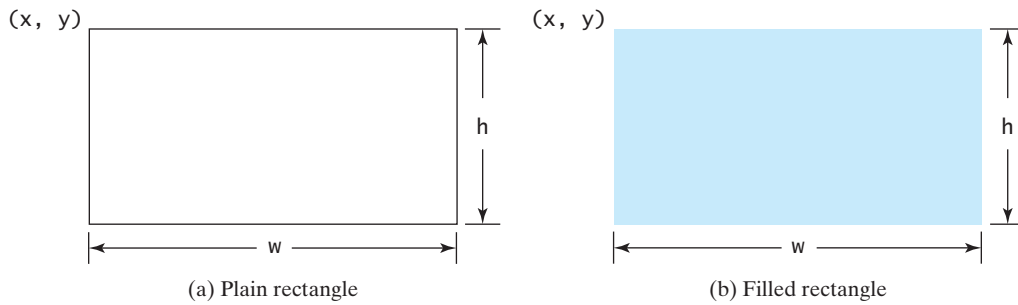


FIGURE 13.6 (a) The `drawRect(x, y, w, h)` method draws a rectangle. (b) The `fillRect(x, y, w, h)` method draws a filled rectangle.

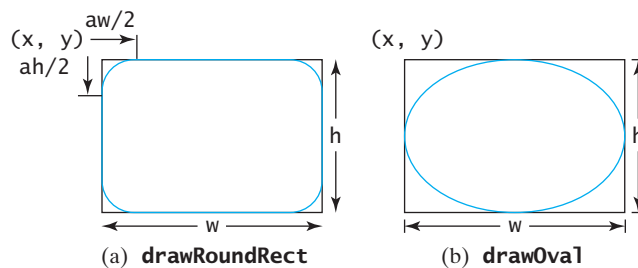


FIGURE 13.7 (a) The `drawRoundRect(x, y, w, h, aw, ah)` method draws a round-cornered rectangle. (b) The `drawOval(x, y, w, h)` method draws an oval based on its bounding rectangle.

In other words, `aw` and `ah` are the width and the height of the oval that produces a quarter-circle at each corner.

`draw3DRect`
`fill3DRect`

The `draw3DRect(int x, int y, int w, int h, boolean raised)` method draws a 3-D rectangle and the `fill3DRect(int x, int y, int w, int h, boolean raised)` method draws a filled 3-D rectangle. The parameters `x`, `y`, `w`, and `h` are the same as in the `drawRect` method. The last parameter, a Boolean value, indicates whether the rectangle is raised above the surface or sunk into the surface.

`drawOval`
`fillOval`

Depending on whether you wish to draw an oval in outline or filled solid, you can use either the `drawOval(int x, int y, int w, int h)` method or the `fillOval(int x, int y, int w, int h)` method. An oval is drawn based on its bounding rectangle. Parameters `x` and `y` indicate the top-left corner of the bounding rectangle, and `w` and `h` indicate the width and height, respectively, of the bounding rectangle, as shown in Figure 13.7b.



MyProgrammingLab™

- 13.6** Describe the methods for drawing strings, lines, and the methods for drawing/filling rectangles, round-cornered rectangles, 3-D rectangles, and ovals.
- 13.7** Draw a thick line from (10, 10) to (70, 30). You can draw several lines next to each other to create the effect of one thick line.
- 13.8** Draw/fill a rectangle of width 100 and height 50 with the upper-left corner at (10, 10).
- 13.9** Draw/fill a round-cornered rectangle with width 100, height 200, corner horizontal diameter 40, and corner vertical diameter 20.
- 13.10** Draw/fill a circle with radius 30.
- 13.11** Draw/fill an oval with width 50 and height 100.

13.4 Case Study: The `FigurePanel` Class

This case study develops the `FigurePanel` class for displaying various figures.

This example develops a useful class for displaying various figures. The class enables the user to set the figure type and specify whether the figure is filled, and it displays the figure on a panel. The UML diagram for the class is shown in Figure 13.8. The panel can display lines, rectangles, round-cornered rectangles, and ovals. Which figure to display is decided by the `type` property. If the `filled` property is `true`, the rectangle, round-cornered rectangle, and oval are filled in the panel.



VideoNote

The `FigurePanel` class

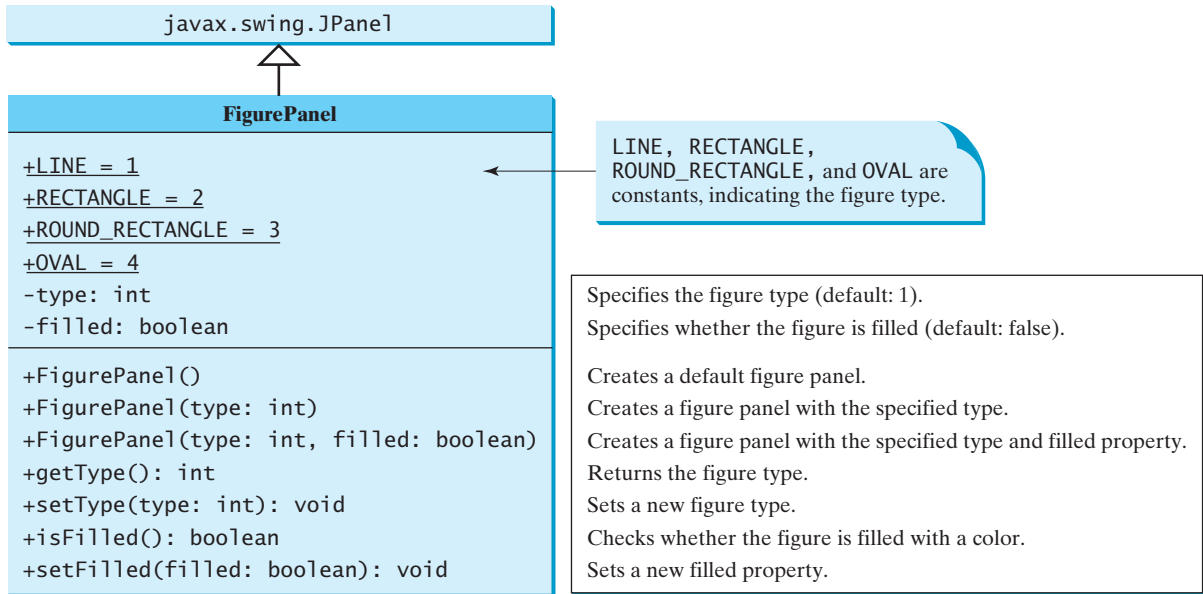


FIGURE 13.8 `FigurePanel` displays various types of figures on the panel.

The UML diagram serves as the contract for the `FigurePanel` class. The user can use the class without knowing how the class is implemented. Let us begin by writing a program in Listing 13.2 that uses the class to display six figure panels, as shown in Figure 13.9.

LISTING 13.2 `TestFigurePanel.java`

```

1  import java.awt.*;
2  import javax.swing.*;
3
4  public class TestFigurePanel extends JFrame {
5      public TestFigurePanel() {
6          setLayout(new GridLayout(2, 3, 5, 5));
7          add(new FigurePanel(FigurePanel.LINE));
8          add(new FigurePanel(FigurePanel.RECTANGLE));
9          add(new FigurePanel(FigurePanel.ROUND_RECTANGLE));
10         add(new FigurePanel(FigurePanel.OVAL));
11         add(new FigurePanel(FigurePanel.RECTANGLE, true));
12         add(new FigurePanel(FigurePanel.ROUND_RECTANGLE, true));
13     }
14
15     public static void main(String[] args) {
16         TestFigurePanel frame = new TestFigurePanel();
17         frame.setSize(400, 200);
18         frame.setTitle("TestFigurePanel");
  
```

create figures

```

19     frame.setLocationRelativeTo(null); // Center the frame
20     frame.setDefaultCloseOperation(JFrame.EXIT_ON_CLOSE);
21     frame.setVisible(true);
22 }
23 }

```

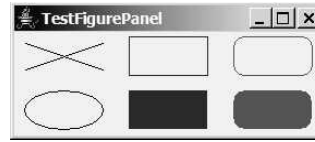


FIGURE 13.9 Six `FigurePanel` objects are created to display six figures.

The `FigurePanel` class is implemented in Listing 13.3. Four constants—`LINE`, `RECTANGLE`, `ROUND_RECTANGLE`, and `OVAL`—are declared in lines 6–9. Four types of figures are drawn according to the `type` property (line 37). The `setColor` method (lines 39, 44, 53, 62) sets a new color for the drawing.

LISTING 13.3 `FigurePanel.java`

```

1  import java.awt.*;
2  import javax.swing.JPanel;
3
4  public class FigurePanel extends JPanel {
5      // Declare constants
6      public static final int LINE = 1;
7      public static final int RECTANGLE = 2;
8      public static final int ROUND_RECTANGLE = 3;
9      public static final int OVAL = 4;
10
11     private int type = 1;
12     private boolean filled = false;
13
14     /** Construct a default FigurePanel */
15     public FigurePanel() {
16     }
17
18     /** Construct a FigurePanel with the specified type */
19     public FigurePanel(int type) {
20         this.type = type;
21     }
22
23     /** Construct a FigurePanel with the specified type and filled */
24     public FigurePanel(int type, boolean filled) {
25         this.type = type;
26         this.filled = filled;
27     }
28
29     @Override // Draw a figure on the panel
30     protected void paintComponent(Graphics g) {
31         super.paintComponent(g);
32
33         // Get the appropriate size for the figure
34         int width = getWidth();
35         int height = getHeight();
36
37         switch (type) {
38             case LINE: // Display two cross lines

```

constants

override
paintComponent(g)

check type

```

39     g.setColor(Color.BLACK);
40     g.drawLine(10, 10, width - 10, height - 10);
41     g.drawLine(width - 10, 10, 10, height - 10);
42     break;
43     case RECTANGLE: // Display a rectangle
44         g.setColor(Color.BLUE);
45         if (filled)
46             g.fillRect((int)(0.1 * width), (int)(0.1 * height),
47                       (int)(0.8 * width), (int)(0.8 * height));
48         else
49             g.drawRect((int)(0.1 * width), (int)(0.1 * height),
50                       (int)(0.8 * width), (int)(0.8 * height));
51         break;
52     case ROUND_RECTANGLE: // Display a round-cornered rectangle
53         g.setColor(Color.RED);
54         if (filled)
55             g.fillRoundRect((int)(0.1 * width), (int)(0.1 * height),
56                            (int)(0.8 * width), (int)(0.8 * height), 20, 20);
57         else
58             g.drawRoundRect((int)(0.1 * width), (int)(0.1 * height),
59                             (int)(0.8 * width), (int)(0.8 * height), 20, 20);
60         break;
61     case OVAL: // Display an oval
62         g.setColor(Color.BLACK);
63         if (filled)
64             g.fillOval((int)(0.1 * width), (int)(0.1 * height),
65                      (int)(0.8 * width), (int)(0.8 * height));
66         else
67             g.drawOval((int)(0.1 * width), (int)(0.1 * height),
68                      (int)(0.8 * width), (int)(0.8 * height));
69     }
70 }
71
72 /** Set a new figure type */
73 public void setType(int type) {
74     this.type = type;
75     repaint();
76 }
77
78 /** Return figure type */
79 public int getType() {
80     return type;
81 }
82
83 /** Set a new filled property */
84 public void setFilled(boolean filled) {
85     this.filled = filled;
86     repaint();
87 }
88
89 /** Check if the figure is filled */
90 public boolean isFilled() {
91     return filled;
92 }
93
94 @Override // Specify preferred size
95 public Dimension getPreferredSize() {
96     return new Dimension(80, 80);
97 }
98 }

```

draw lines

fill a rectangle

draw a rectangle

fill round-cornered rect

draw round-cornered rect

fill an oval

draw an oval

repaint panel

repaint panel

override
getPreferredSize()

The `repaint` method (lines 75, 86) is defined in the `Component` class. Invoking `repaint` causes the `paintComponent` method to be called. The `repaint` method is invoked to refresh the viewing area. Typically, you call it if you have new things to display.

don't invoke
`paintComponent`



Caution

The `paintComponent` method should never be invoked directly. It is invoked either by the JVM whenever the viewing area changes or by the `repaint` method. You should override the `paintComponent` method to tell the system how to paint the viewing area, but never override the `repaint` method.

request repaint using
`repaint()`



Note

The `repaint` method lodges a request to update the viewing area and returns immediately. Its effect is asynchronous, meaning that it is up to the JVM to execute the `paintComponent` method on a separate thread.

The `getPreferredSize()` method (lines 95–97), defined in `Component`, is overridden in `FigurePanel` to specify the preferred size for the layout manager to consider when laying out a `FigurePanel` object. This property may or may not be considered by the layout manager, depending on its rules. For example, a component uses its preferred size in a container with a `FlowLayout` manager, but its preferred size is ignored if it is placed in a container with a `GridLayout` manager. It is a good practice to override `getPreferredSize()` in a subclass of `JPanel` to specify a preferred size, because the default width and height for a `JPanel` is 0. You will see nothing if a `JPanel` component with a default 0 width and height is placed in a `FlowLayout` container.

why override
`getPreferredSize()`?



13.12 Why should you override the `preferredSize` method in a subclass of `JPanel`?

13.13 How do you `get` and `set` colors and fonts in a `Graphics` object?

MyProgrammingLab™

13.5 Drawing Arcs

An arc is conceived as part of an oval bounded by a rectangle.



The methods to draw or fill an arc are as follows:

```
drawArc(int x, int y, int w, int h, int startAngle, int arcAngle)
fillArc(int x, int y, int w, int h, int startAngle, int arcAngle)
```

Parameters `x`, `y`, `w`, and `h` are the same as in the `drawOval` method; parameter `startAngle` is the starting angle; and `arcAngle` is the spanning angle (i.e., the angle covered by the arc). Angles are measured in degrees and follow the usual mathematical conventions (i.e., 0 degrees is in the easterly direction, and positive angles indicate counterclockwise rotation from the easterly direction); see Figure 13.10.

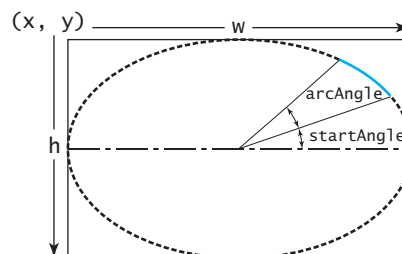


FIGURE 13.10 The `drawArc` method draws an arc based on an oval with specified angles.

Listing 13.4 is an example of how to draw arcs; the output is shown in Figure 13.11.

LISTING 13.4 DrawArcs.java

```

1  import javax.swing.JFrame;
2  import javax.swing.JPanel;
3  import java.awt.Graphics;
4
5  public class DrawArcs extends JFrame {
6      public DrawArcs() {
7          setTitle("DrawArcs");
8          add(new ArcsPanel());
9      }
10
11     /** Main method */
12     public static void main(String[] args) {
13         DrawArcs frame = new DrawArcs();
14         frame.setSize(250, 300);
15         frame.setLocationRelativeTo(null); // Center the frame
16         frame.setDefaultCloseOperation(JFrame.EXIT_ON_CLOSE);
17         frame.setVisible(true);
18     }
19 }
20
21 // The class for drawing arcs on a panel
22 class ArcsPanel extends JPanel {
23     @Override // Draw four blades of a fan
24     protected void paintComponent(Graphics g) {
25         super.paintComponent(g);
26
27         int xCenter = getWidth() / 2;
28         int yCenter = getHeight() / 2;
29         int radius = (int)(Math.min(getWidth(), getHeight()) * 0.4);
30
31         int x = xCenter - radius;
32         int y = yCenter - radius;
33
34         g.fillArc(x, y, 2 * radius, 2 * radius, 0, 30);
35         g.fillArc(x, y, 2 * radius, 2 * radius, 90, 30);
36         g.fillArc(x, y, 2 * radius, 2 * radius, 180, 30);
37         g.fillArc(x, y, 2 * radius, 2 * radius, 270, 30);
38     }
39 }

```

add a panel

override paintComponent

30° arc from 0°
30° arc from 90°
30° arc from 180°
30° arc from 270°

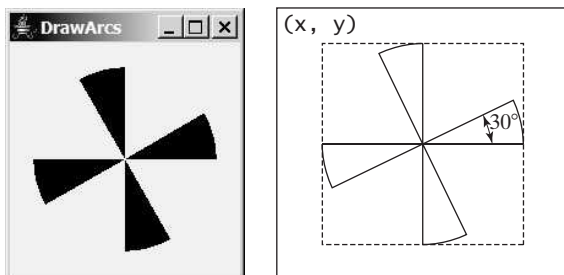


FIGURE 13.11 The program draws four filled arcs.

negative degrees

Angles may be negative. A negative starting angle sweeps clockwise from the easterly direction, as shown in Figure 13.12. A negative spanning angle sweeps clockwise from the starting angle. The following two statements draw the same arc:

```
g.fillArc(x, y, 2 * radius, 2 * radius, -30, -20);
g.fillArc(x, y, 2 * radius, 2 * radius, -50, 20);
```

The first statement uses negative starting angle -30 and negative spanning angle -20 , as shown in Figure 13.12a. The second statement uses negative starting angle -50 and positive spanning angle 20 , as shown in Figure 13.12b.

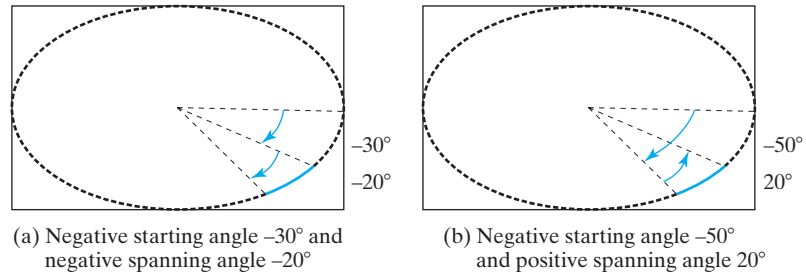


FIGURE 13.12 Angles may be negative.



13.14 Describe the methods for drawing/filling arcs.

13.15 Draw the upper half of a circle with radius **50**.

13.16 Fill the lower half of a circle with radius **50** using the red color.

MyProgrammingLab™

13.6 Drawing Polygons and Polylines



You can draw a polygon or a polyline that connects a set of points.

To draw a polygon, first create a **Polygon** object using the **Polygon** class, as shown in Figure 13.13.

java.awt.Polygon	
+xpoints: int[]	x-coordinates of all points in the polygon.
+ypoints: int[]	y-coordinates of all points in the polygon.
+npoints: int	The number of points in the polygon.
<hr/>	
+Polygon()	Creates an empty polygon.
+Polygon(xpoints: int[], ypoints: int[], npoints: int)	Creates a polygon with the specified points.
+addPoint(x: int, y: int): void	Appends a point to the polygon.
+contains(x: int, y: int): boolean	Returns true if the specified point (x, y) is contained in the polygon.

FIGURE 13.13 The **Polygon** class models a polygon.

A polygon is a closed two-dimensional region. This region is bounded by an arbitrary number of line segments, each being one side (or edge) of the polygon. A polygon comprises a list of **(x, y)**-coordinate pairs in which each pair defines a vertex of the polygon, and two successive pairs are the endpoints of a line that is a side of the polygon. The first and final points are joined by a line segment that closes the polygon.

Here is an example of creating a polygon and adding points into it:

```
Polygon polygon = new Polygon();
polygon.addPoint(40, 20);
polygon.addPoint(70, 40);
polygon.addPoint(60, 80);
polygon.addPoint(45, 45);
polygon.addPoint(20, 60);
```

After these points are added, `xpoints` is {40, 70, 60, 45, 20}, `ypoints` is {20, 40, 80, 45, 60}, and `npoints` is 5. `xpoints`, `ypoints`, and `npoints` are public data fields in `Polygon`, which is a bad design. If the user changes a `Polygon`'s `npoints` data field without properly changing its `xpoints` and `ypoints` data fields, this will cause inconsistent data in the `Polygon` object.

To draw or fill a polygon, use one of the following methods in the `Graphics` class:

```
drawPolygon(Polygon polygon);
fillPolygon(Polygon polygon);

drawPolygon(int[] xpoints, int[] ypoints, int npoints);
fillPolygon(int[] xpoints, int[] ypoints, int npoints);
```

For example:

```
int x[] = {40, 70, 60, 45, 20};
int y[] = {20, 40, 80, 45, 60};
g.drawPolygon(x, y, x.length);
```

The drawing method opens the polygon by drawing lines between point `(x[i], y[i])` and point `(x[i+1], y[i+1])` for $i = 0, \dots, x.length-1$; it closes the polygon by drawing a line between the first and last points (see Figure 13.14a).

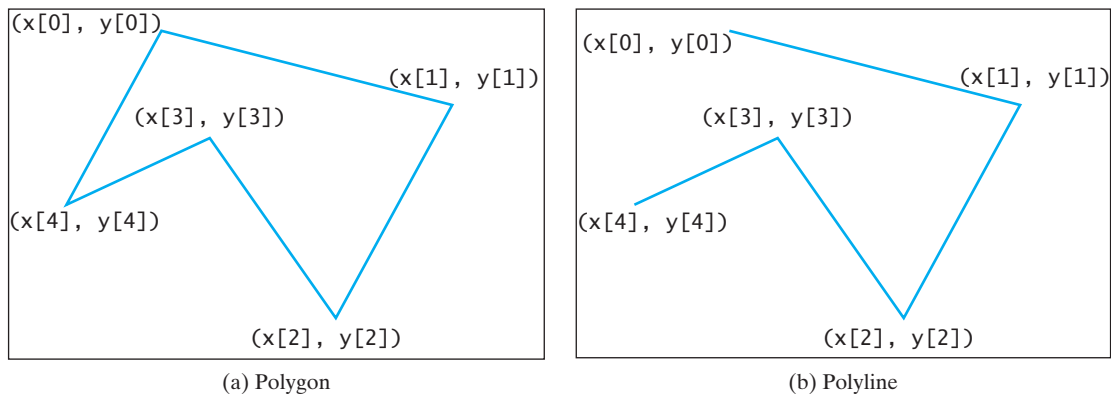


FIGURE 13.14 The `drawPolygon` method draws a polygon, and the `drawPolyLine` method draws a polyline.

To draw a polyline, use the `drawPolyline(int[] x, int[] y, int nPoints)` method, which draws a sequence of connected lines defined by arrays of x - and y -coordinates. For example, the following code draws the polyline like the one shown in Figure 13.14b.

```
int x[] = {40, 70, 60, 45, 20};
int y[] = {20, 40, 80, 45, 60};
g.drawPolyline(x, y, x.length);
```

Listing 13.5 is an example of how to draw a hexagon, with the output shown in Figure 13.15.

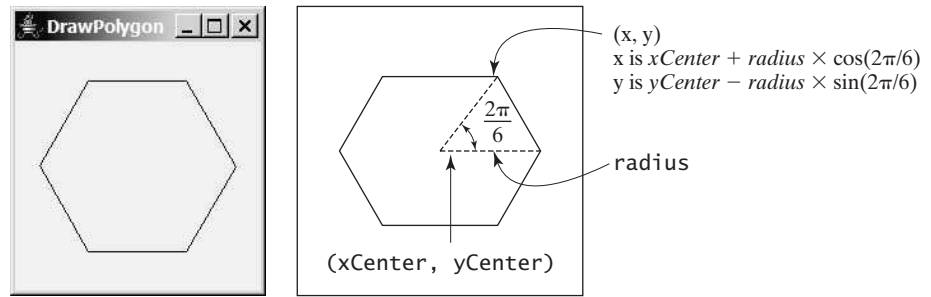


FIGURE 13.15 The program uses the `drawPolygon` method to draw a hexagon.

LISTING 13.5 DrawPolygon.java

```

1  import javax.swing.JFrame;
2  import javax.swing.JPanel;
3  import java.awt.Graphics;
4  import java.awt.Polygon;
5
6  public class DrawPolygon extends JFrame {
7      public DrawPolygon() {
8          setTitle("DrawPolygon");
9          add(new PolygonsPanel());
10     }
11
12     /** Main method */
13     public static void main(String[] args) {
14         DrawPolygon frame = new DrawPolygon();
15         frame.setSize(200, 250);
16         frame.setLocationRelativeTo(null); // Center the frame
17         frame.setDefaultCloseOperation(JFrame.EXIT_ON_CLOSE);
18         frame.setVisible(true);
19     }
20 }
21
22 // Draw a polygon in the panel
23 class PolygonsPanel extends JPanel {
24     @Override
25     protected void paintComponent(Graphics g) {
26         super.paintComponent(g);
27
28         int xCenter = getWidth() / 2;
29         int yCenter = getHeight() / 2;
30         int radius = (int)(Math.min(getWidth(), getHeight()) * 0.4);
31
32         // Create a Polygon object
33         Polygon polygon = new Polygon();
34
35         // Add points to the polygon in this order
36         polygon.addPoint(xCenter + radius, yCenter);
37         polygon.addPoint((int)(xCenter + radius *
38             Math.cos(2 * Math.PI / 6)), (int)(yCenter - radius *
39             Math.sin(2 * Math.PI / 6)));
40         polygon.addPoint((int)(xCenter + radius *
41             Math.cos(2 * 2 * Math.PI / 6)), (int)(yCenter - radius *
42             Math.sin(2 * 2 * Math.PI / 6)));
43         polygon.addPoint((int)(xCenter + radius *
44             Math.cos(3 * 2 * Math.PI / 6)), (int)(yCenter - radius *
45             Math.sin(3 * 2 * Math.PI / 6)));

```

add a panel

paintComponent

add a point


```

46 polygon.addPoint((int)(xCenter + radius *
47     Math.cos(4 * 2 * Math.PI / 6)), (int)(yCenter - radius *
48     Math.sin(4 * 2 * Math.PI / 6)));
49 polygon.addPoint((int)(xCenter + radius *
50     Math.cos(5 * 2 * Math.PI / 6)), (int)(yCenter - radius *
51     Math.sin(5 * 2 * Math.PI / 6)));
52
53 // Draw the polygon
54 g.drawPolygon(polygon);
55 }
56 }

```

draw polygon

13.17 Draw a polygon connecting the following points: (20, 40), (30, 50), (40, 90), (90, 10), (10, 30).



13.18 Create a **Polygon** object and add points (20, 40), (30, 50), (40, 90), (90, 10), (10, 30) in this order. Fill the polygon with the red color. Draw a polyline with a yellow color to connect all these points.

MyProgrammingLab™

13.7 Centering a String Using the **FontMetrics** Class

You can use the **FontMetrics** class to measure the width and height of a string in the graphics context.



You can display a string at any location in a panel. Can you display it centered? Yes; to do so, you need to use the **FontMetrics** class to measure the exact width and height of the string for a particular font. **FontMetrics** can measure the following attributes for a given font (see Figure 13.16):

- **Leading**, pronounced *ledging*, is the amount of space between lines of text.
- **Ascent** is the distance from the baseline to the ascent line. The top of most characters in the font will be under the ascent line, but some may extend above the ascent line.
- **Descent** is the distance from the baseline to the descent line. The bottom of most descending characters (e.g., *j*, *y*, and *g*) in the font will be above the descent line, but some may extend below the descent line.
- **Height** is the sum of leading, ascent, and descent.

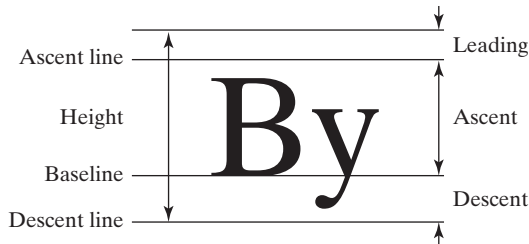


FIGURE 13.16 The **FontMetrics** class can be used to determine the font properties of characters for a given font.

FontMetrics is an abstract class. To get a **FontMetrics** object for a specific font, use the following **getFontMetrics** methods defined in the **Graphics** class:

- **public** **FontMetrics** getFontMetrics(**Font** font)

This method returns the font metrics of the specified font.

- **public** **FontMetrics** getFontMetrics()

This method returns the font metrics of the current font.

You can use the following instance methods in the `FontMetrics` class to obtain the attributes of a font and the width of a string when it is drawn using the font:

```
public int getAscent() // Return the ascent
public int getDescent() // Return the descent
public int getLeading() // Return the leading
public int getHeight() // Return the height
public int stringWidth(String str) // Return the width of the string
```

Listing 13.6 gives an example that displays a message in the center of the panel, as shown in Figure 13.17.

LISTING 13.6 TestCenterMessage.java

```
1  import javax.swing.*;
2  import java.awt.*;
3
4  public class TestCenterMessage extends JFrame {
5      public TestCenterMessage() {
6          CenterMessage messagePanel = new CenterMessage();
7          add(messagePanel);
8          messagePanel.setBackground(Color.WHITE);
9          messagePanel.setFont(new Font("Californian FB", Font.BOLD, 30));
10     }
11
12     /** Main method */
13     public static void main(String[] args) {
14         TestCenterMessage frame = new TestCenterMessage();
15         frame.setSize(300, 150);
16         frame.setTitle("CenterMessage");
17         frame.setLocationRelativeTo(null); // Center the frame
18         frame.setDefaultCloseOperation(JFrame.EXIT_ON_CLOSE);
19         frame.setVisible(true);
20     }
21 }
22
23 class CenterMessage extends JPanel {
24     @Override /** Paint the message */
25     protected void paintComponent(Graphics g) {
26         super.paintComponent(g);
27
28         // Get font metrics for the current font
29         FontMetrics fm = g.getFontMetrics();
30
31         // Find the center location to display
32         int stringWidth = fm.stringWidth("Welcome to Java");
33         int stringAscent = fm.getAscent();
34
35         // Get the position of the leftmost character in the baseline
36         int xCoordinate = getWidth() / 2 - stringWidth / 2;
37         int yCoordinate = getHeight() / 2 + stringAscent / 2;
38
39         g.drawString("Welcome to Java", xCoordinate, yCoordinate);
40     }
41 }
```

create a message panel
add a message panel
set background
set font

override paintComponent

get FontMetrics

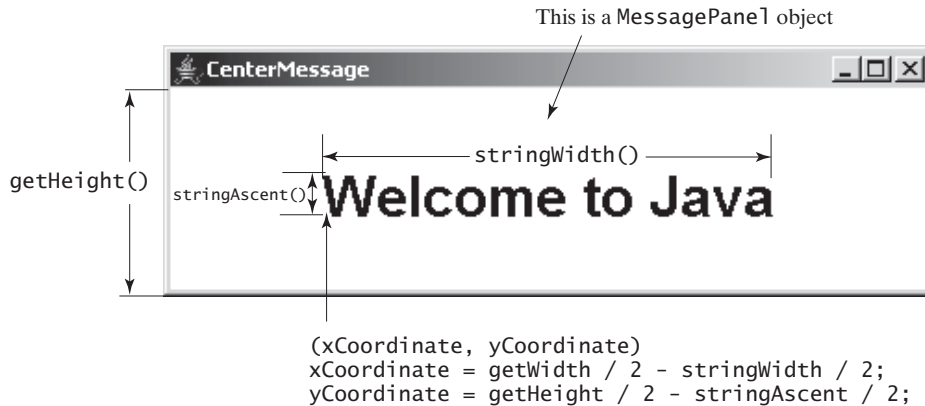


FIGURE 13.17 The program uses the `FontMetrics` class to measure the string width and height and displays it at the center of the panel.

The methods `getWidth()` and `getHeight()` (lines 36–37) defined in the `Component` class return the component's width and height, respectively.

Since the message is **centered**, the first character of the string should be positioned at (`xCoordinate`, `yCoordinate`), as shown in Figure 13.17.

13.19 How do you find the leading, ascent, descent, and height of a font?

13.20 How do you find the exact length in pixels of a string in a `Graphics` object?



MyProgrammingLab™

13.8 Case Study: The `MessagePanel` Class

This case study develops a useful class that displays a message in a panel. The class enables the user to set the location of the message, center the message, and move the message a specified interval.



The contract of the `MessagePanel` class is shown in Figure 13.18.

Let us first write a test program in Listing 13.7 that uses the `MessagePanel` class to display four message panels, as shown in Figure 13.19.



VideoNote

The `MessagePanel` class

LISTING 13.7 `TestMessagePanel.java`

```

1  import java.awt.*;
2  import javax.swing.*;
3
4  public class TestMessagePanel extends JFrame {
5      public TestMessagePanel() {
6          MessagePanel messagePanel1 = new MessagePanel("Welcome to Java"); // create message panel
7          MessagePanel messagePanel2 = new MessagePanel("Java is fun");
8          MessagePanel messagePanel3 = new MessagePanel("Java is cool");
9          MessagePanel messagePanel4 = new MessagePanel("I love Java");
10         messagePanel1.setFont(new Font("SansSerif", Font.ITALIC, 20)); // set font
11         messagePanel2.setFont(new Font("Courier", Font.BOLD, 20));
12         messagePanel3.setFont(new Font("Times", Font.ITALIC, 20));
13         messagePanel4.setFont(new Font("Californian FB", Font.PLAIN, 20));
14         messagePanel1.setBackground(Color.RED); // set background
15         messagePanel2.setBackground(Color.CYAN);
16         messagePanel3.setBackground(Color.GREEN);
17         messagePanel4.setBackground(Color.WHITE);

```

```

18     messagePanel1.setCentered(true);
19
20     setLayout(new GridLayout(2, 2));
21     add(messagePanel1);
22     add(messagePanel2);
23     add(messagePanel3);
24     add(messagePanel4);
25 }
26
27 public static void main(String[] args) {
28     TestMessagePanel frame = new TestMessagePanel();
29     frame.setSize(300, 200);
30     frame.setTitle("TestMessagePanel");
31     frame.setLocationRelativeTo(null); // Center the frame
32     frame.setDefaultCloseOperation(JFrame.EXIT_ON_CLOSE);
33     frame.setVisible(true);
34 }
35 }

```

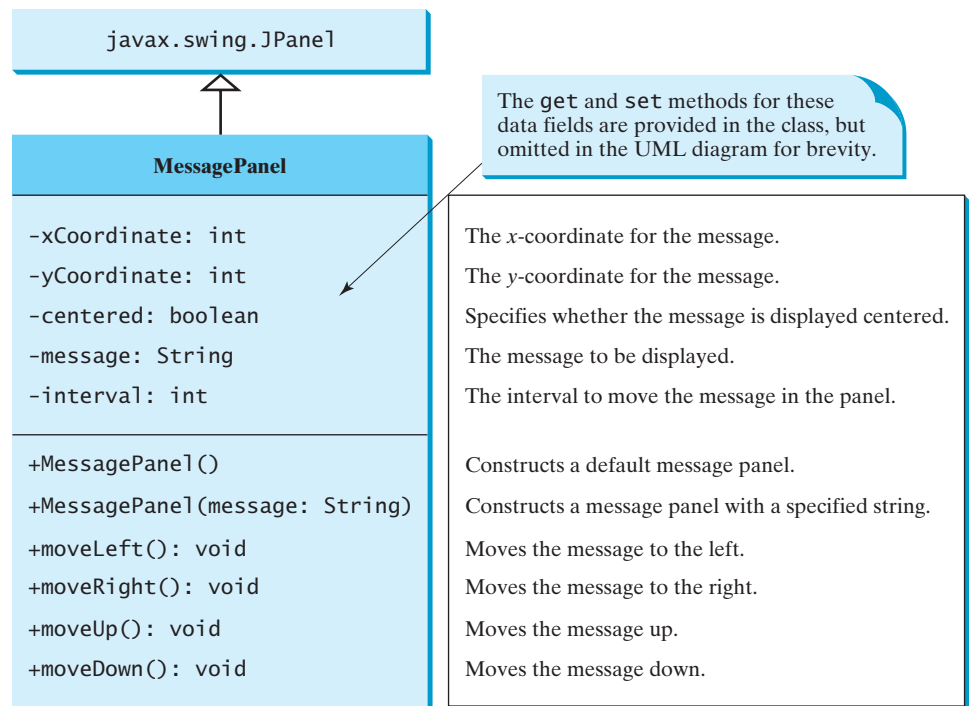


FIGURE 13.18 `MessagePanel` displays a message on the panel.

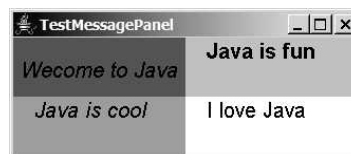


FIGURE 13.19 `TestMessagePanel` uses `MessagePanel` to display four message panels.

skip implementation?

The rest of this section explains how to implement the `MessagePanel` class. Since you can use the class without knowing how it is implemented, you may skip the implementation if you wish.

The `MessagePanel` class is implemented in Listing 13.8. The program seems long but is actually simple, because most of the methods are `get` and `set` methods, and each method is relatively short and easy to read.

LISTING 13.8 `MessagePanel.java`

```

1  import java.awt.FontMetrics;
2  import java.awt.Dimension;
3  import java.awt.Graphics;
4  import javax.swing.JPanel;
5
6  public class MessagePanel extends JPanel {
7      /** The message to be displayed */
8      private String message = "Welcome to Java";
9
10     /** The x-coordinate where the message is displayed */
11     private int xCoordinate = 20;
12
13     /** The y-coordinate where the message is displayed */
14     private int yCoordinate = 20;
15
16     /** Indicate whether the message is displayed in the center */
17     private boolean centered;
18
19     /** The interval for moving the message horizontally
20      * and vertically */
21     private int interval = 10;
22
23     /** Construct with default properties */
24     public MessagePanel() {
25     }
26
27     /** Construct a message panel with a specified message */
28     public MessagePanel(String message) {
29         this.message = message;
30     }
31
32     /** Return message */
33     public String getMessage() {
34         return message;
35     }
36
37     /** Set a new message */
38     public void setMessage(String message) {
39         this.message = message;
40         repaint();
41     }
42
43     /** Return xCoordinator */
44     public int getXCoordinate() {
45         return xCoordinate;
46     }
47
48     /** Set a new xCoordinator */
49     public void setXCoordinate(int x) {
50         this.xCoordinate = x;
51         repaint();
52     }
53
54     /** Return yCoordinator */

```

```

55     public int getYCoordinate() {
56         return yCoordinate;
57     }
58
59     /** Set a new yCoordinator */
60     public void setYCoordinate(int y) {
61         this.yCoordinate = y;
62         repaint();
63     }
64
65     /** Return centered */
66     public boolean isCentered() {
67         return centered;
68     }
69
70     /** Set true or false to tell whether the message is centered */
71     public void setCentered(boolean centered) {
72         this.centered = centered;
73         repaint();
74     }
75
76     /** Return interval */
77     public int getInterval() {
78         return interval;
79     }
80
81     /** Set a new interval */
82     public void setInterval(int interval) {
83         this.interval = interval;
84         repaint();
85     }
86
87     @Override /** Paint the message */
88     protected void paintComponent(Graphics g) {
89         super.paintComponent(g);
90
91         if (centered) {
92             // Get font metrics for the current font
93             FontMetrics fm = g.getFontMetrics();
94
95             // Find the center location to display
96             int stringWidth = fm.stringWidth(message);
97             int stringAscent = fm.getAscent();
98             // Get the position of the leftmost character in the baseline
99             xCoordinate = getWidth() / 2 - stringWidth / 2;
100            yCoordinate = getHeight() / 2 + stringAscent / 2;
101        }
102
103        g.drawString(message, xCoordinate, yCoordinate);
104    }
105
106    /** Move the message left */
107    public void moveLeft() {
108        xCoordinate -= interval;
109        repaint();
110    }
111
112    /** Move the message right */
113    public void moveRight() {
114        xCoordinate += interval;

```

```

115     repaint();
116 }
117
118 /** Move the message up */
119 public void moveUp() {
120     yCoordinate -= interval;
121     repaint();
122 }
123
124 /** Move the message down */
125 public void moveDown() {
126     yCoordinate += interval;
127     repaint();
128 }
129
130 @Override /** Override get method for preferredSize */
131 public Dimension getPreferredSize() {
132     return new Dimension(200, 30);
133 }
134 }

```

override
getPreferredSize

The `paintComponent` method displays the message centered, if the `centered` property is `true` (line 91). `message` is initialized to `Welcome to Java` in line 8. If it were not initialized, a `NullPointerException` runtime error would occur when you created a `MessagePanel` using the no-arg constructor, because `message` would be `null` in line 103.



Caution

The `MessagePanel` class uses the properties `xCoordinate` and `yCoordinate` to specify the position of the message displayed on the panel. Do not use the property names `x` and `y`, because they are already defined in the `Component` class to return the position of the component in the parent's coordinate system using `getX()` and `getY()`.



Note

The `Component` class has the `setBackground`, `setForeground`, and `setFont` methods. These methods are for setting colors and fonts for the entire component. If you wanted to draw several messages in a panel with different colors and fonts, you would have to use the `setColor` and `setFont` methods in the `Graphics` class to set the color and font for the current drawing.



Note

A key feature of Java programming is the reuse of classes. Throughout this book, reusable classes are developed and later reused. `MessagePanel` is an example, as are `Loan` in Listing 10.2 and `FigurePanel` in Listing 13.3. `MessagePanel` can be reused whenever you need to display a message on a panel. To make your class reusable in a wide range of applications, you should provide a variety of ways to use it. `MessagePanel` provides many properties and methods that will be used in several examples in the book.

design classes for reuse

13.21 If `message` is not initialized in line 8 in Listing 13.8, `MessagePanel.java`, what will happen when you create a `MessagePanel` using its no-arg constructor?

13.22 The following program is supposed to display a message on a panel, but nothing is displayed. There are problems in lines 2 and 15. Correct them.



```

1 public class TestDrawMessage extends javax.swing.JFrame {
2     public void TestDrawMessage() {
3         add(new DrawMessage());
4     }
5
6     public static void main(String[] args) {
7         javax.swing.JFrame frame = new TestDrawMessage();
8         frame.setSize(100, 200);
9         frame.setVisible(true);
10    }
11 }
12
13 class DrawMessage extends javax.swing.JPanel {
14     @Override
15     protected void PaintComponent(java.awt.Graphics g) {
16         super.paintComponent(g);
17         g.drawString("Welcome to Java", 20, 20);
18     }
19 }

```

13.9 Case Study: The StillClock Class

This case study develops a class that displays a clock on a panel.

The contract of the **StillClock** class is shown in Figure 13.20.



VideoNote

The StillClock class

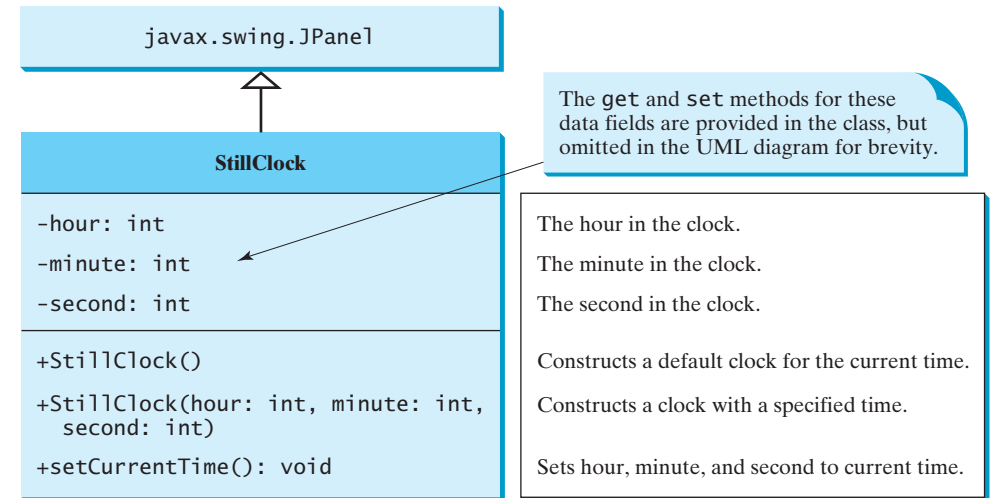


FIGURE 13.20 **StillClock** displays an analog clock.

Let us first write a test program in Listing 13.9 that uses the **StillClock** class to display an analog clock and uses the **MessagePanel** class to display the hour, minute, and second in a panel, as shown in Figure 13.21a.

LISTING 13.9 DisplayClock.java

```

1 import java.awt.*;
2 import javax.swing.*;
3
4 public class DisplayClock extends JFrame {

```



```

5  public DisplayClock() {
6      // Create an analog clock for the current time
7      StillClock clock = new StillClock();
8
9      // Display hour, minute, and second in the message panel
10     MessagePanel messagePanel = new MessagePanel(clock.getHour() +
11     ":" + clock.getMinute() + ":" + clock.getSecond());
12     messagePanel.setCentered(true);
13     messagePanel.setForeground(Color.blue);
14     messagePanel.setFont(new Font("Courier", Font.BOLD, 16));
15
16     // Add the clock and message panel to the frame
17     add(clock);
18     add(messagePanel, BorderLayout.SOUTH);
19 }
20
21 public static void main(String[] args) {
22     DisplayClock frame = new DisplayClock();
23     frame.setTitle("DisplayClock");
24     frame.setSize(300, 350);
25     frame.setLocationRelativeTo(null); // Center the frame
26     frame.setDefaultCloseOperation(JFrame.EXIT_ON_CLOSE);
27     frame.setVisible(true);
28 }
29 }

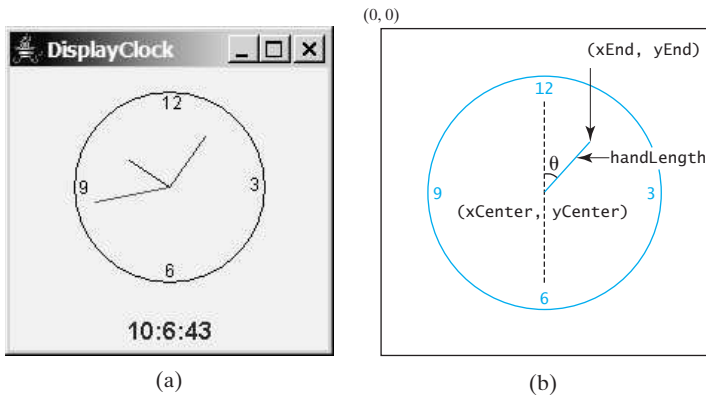
```

create a clock

create a message panel

add a clock

add a message panel



(a)

(b)

FIGURE 13.21 (a) The `DisplayClock` program displays a clock that shows the current time. (b) The endpoint of a clock hand can be determined, given the spanning angle, the hand length, and the center point.

The rest of this section explains how to implement the `StillClock` class. Since you can use the class without knowing how it is implemented, you may skip the implementation if you wish.

skip implementation?

To draw a clock, you need to draw a circle and three hands for the second, minute, and hour. To draw a hand, you need to specify the two ends of the line. As shown in Figure 13.21b, one end is the center of the clock at `(xCenter, yCenter)`; the other end, at `(xEnd, yEnd)`, is determined by the following formula:

implementation

$$\begin{aligned}
 xEnd &= xCenter + handLength \times \sin(\theta) \\
 yEnd &= yCenter - handLength \times \cos(\theta)
 \end{aligned}$$

Since there are 60 seconds in one minute, the angle for the second hand is

$$second \times (2\pi/60)$$

The position of the minute hand is determined by the minute and second. The exact minute value combined with seconds is `minute + second/60`. For example, if the time is 3 minutes and 30 seconds, the total minutes are 3.5. Since there are 60 minutes in one hour, the angle for the minute hand is

$$(\text{minute} + \text{second}/60) \times (2\pi/60)$$

Since one circle is divided into 12 hours, the angle for the hour hand is

$$(\text{hour} + \text{minute}/60 + \text{second}/(60 \times 60)) \times (2\pi/12)$$

For simplicity in computing the angles of the minute hand and hour hand, you can omit the seconds, because they are negligibly small. Therefore, the endpoints for the second hand, minute hand, and hour hand can be computed as:

```
xSecond = xCenter + secondHandLength × sin(second × (2π/60))
ySecond = yCenter - secondHandLength × cos(second × (2π/60))
xMinute = xCenter + minuteHandLength × sin(minute × (2π/60))
yMinute = yCenter - minuteHandLength × cos(minute × (2π/60))
xHour = xCenter + hourHandLength × sin((hour + minute/60) × (2π/12))
yHour = yCenter - hourHandLength × cos((hour + minute/60) × (2π/12))
```

The `StillClock` class is implemented in Listing 13.10.

LISTING 13.10 StillClock.java

```
1 import java.awt.*;
2 import javax.swing.*;
3 import java.util.*;
4
5 public class StillClock extends JPanel {
6     private int hour;
7     private int minute;
8     private int second;
9
10    /** Construct a default clock with the current time*/
11    public StillClock() {
12        setCurrentTime();
13    }
14
15    /** Construct a clock with specified hour, minute, and second */
16    public StillClock(int hour, int minute, int second) {
17        this.hour = hour;
18        this.minute = minute;
19        this.second = second;
20    }
21
22    /** Return hour */
23    public int getHour() {
24        return hour;
25    }
26
27    /** Set a new hour */
28    public void setHour(int hour) {
29        this.hour = hour;
30        repaint();
31    }
32
33    /** Return minute */
```

repaint panel

```

34 public int getMinute() {
35     return minute;
36 }
37
38 /** Set a new minute */
39 public void setMinute(int minute) {
40     this.minute = minute;
41     repaint();
42 }
43
44 /** Return second */
45 public int getSecond() {
46     return second;
47 }
48
49 /** Set a new second */
50 public void setSecond(int second) {
51     this.second = second;
52     repaint();
53 }
54
55 @Override /** Draw the clock */
56 protected void paintComponent(Graphics g) {
57     super.paintComponent(g);
58
59     // Initialize clock parameters
60     int clockRadius =
61         (int)(Math.min(getWidth(), getHeight()) * 0.8 * 0.5);
62     int xCenter = getWidth() / 2;
63     int yCenter = getHeight() / 2;
64
65     // Draw circle
66     g.setColor(Color.BLACK);
67     g.drawOval(xCenter - clockRadius, yCenter - clockRadius,
68         2 * clockRadius, 2 * clockRadius);
69     g.drawString("12", xCenter - 5, yCenter - clockRadius + 12);
70     g.drawString("9", xCenter - clockRadius + 3, yCenter + 5);
71     g.drawString("3", xCenter + clockRadius - 10, yCenter + 3);
72     g.drawString("6", xCenter - 3, yCenter + clockRadius - 3);
73
74     // Draw second hand
75     int sLength = (int)(clockRadius * 0.8);
76     int xSecond = (int)(xCenter + sLength *
77         Math.sin(second * (2 * Math.PI / 60)));
78     int ySecond = (int)(yCenter - sLength *
79         Math.cos(second * (2 * Math.PI / 60)));
80     g.setColor(Color.red);
81     g.drawLine(xCenter, yCenter, xSecond, ySecond);
82
83     // Draw minute hand
84     int mLength = (int)(clockRadius * 0.65);
85     int xMinute = (int)(xCenter + mLength *
86         Math.sin(minute * (2 * Math.PI / 60)));
87     int yMinute = (int)(yCenter - mLength *
88         Math.cos(minute * (2 * Math.PI / 60)));
89     g.setColor(Color.blue);
90     g.drawLine(xCenter, yCenter, xMinute, yMinute);
91
92     // Draw hour hand
93     int hLength = (int)(clockRadius * 0.5);

```

repaint panel

repaint panel

override paintComponent

```

94     int xHour = (int)(xCenter + hLength *
95         Math.sin((hour % 12 + minute / 60.0) * (2 * Math.PI / 12)));
96     int yHour = (int)(yCenter - hLength *
97         Math.cos((hour % 12 + minute / 60.0) * (2 * Math.PI / 12)));
98     g.setColor(Color.green);
99     g.drawLine(xCenter, yCenter, xHour, yHour);
100 }
101
102 public void setCurrentTime() {
103     // Construct a calendar for the current date and time
104     Calendar calendar = new GregorianCalendar();
105
106     // Set current hour, minute, and second
107     this.hour = calendar.get(Calendar.HOUR_OF_DAY);
108     this.minute = calendar.get(Calendar.MINUTE);
109     this.second = calendar.get(Calendar.SECOND);
110 }
111
112 @Override
113 public Dimension getPreferredSize() {
114     return new Dimension(200, 200);
115 }
116 }

```

get current time

override
getPreferredSize

The program enables the clock size to adjust as the frame resizes. Every time you resize the frame, the `paintComponent` method is automatically invoked to paint a new clock. The `paintComponent` method displays the clock in proportion to the panel width (`getWidth()`) and height (`getHeight()`) (lines 60–63 in `StillClock`).

13.10 Displaying Images



Key
Point

You can draw images in a graphics context.

You learned how to create image icons and display them in labels and buttons in Section 12.10, Image Icons. For example, the following statements create an image icon and display it in a label:

```

ImageIcon imageIcon = new ImageIcon("image/us.gif");
JLabel jlblImage = new JLabel(imageIcon);

```

An image icon displays a fixed-size image. To display an image in a flexible size, you need to use the `java.awt.Image` class. An image can be created from an image icon using the `getImage()` method as follows:

```

Image image = imageIcon.getImage();

```

Using a label as an area for displaying images is simple and convenient, but you don't have much control over how the image is displayed. A more flexible way to display images is to use the `drawImage` method of the `Graphics` class on a panel. Four versions of the `drawImage` method are shown in Figure 13.22.

`ImageObserver` specifies a GUI component for receiving notifications of image information as the image is constructed. To draw images using the `drawImage` method in a Swing component, such as `JPanel`, override the `paintComponent` method to tell the component how to display the image in the panel.

Listing 13.11 gives the code that displays an image from `image/us.gif`. The file `image/us.gif` (line 20) is under the class directory. An `Image` object is obtained in line 21. The `drawImage` method displays the image to fill in the whole panel, as shown in Figure 13.23.

<i>java.awt.Graphics</i>	
<pre>+drawImage(image: Image, x: int, y: int, bgcolor: Color, observer: ImageObserver): void +drawImage(image: Image, x: int, y: int, observer: ImageObserver): void +drawImage(image: Image, x: int, y: int, width: int, height: int, observer: ImageObserver): void +drawImage(image: Image, x: int, y: int, width: int, height: int, bgcolor: Color, observer: ImageObserver): void</pre>	<p>Draws the image in a specified location. The image's top-left corner is at (x, y) in the graphics context's coordinate space. Transparent pixels in the image are drawn in the specified color <code>bgcolor</code>. The observer is the object on which the image is displayed. The image is cut off if it is larger than the area it is being drawn on.</p> <p>Same as the preceding method except that it does not specify a background color.</p> <p>Draws a scaled version of the image that can fill all of the available space in the specified rectangle.</p> <p>Same as the preceding method except that it provides a solid background color behind the image being drawn.</p>

FIGURE 13.22 You can apply the `drawImage` method on a `Graphics` object to display an image on a GUI component.

LISTING 13.11 DisplayImage.java

```
1  import java.awt.*;
2  import javax.swing.*;
3
4  public class DisplayImage extends JFrame {
5      public DisplayImage() {
6          add(new ImagePanel());           add panel
7      }
8
9      public static void main(String[] args) {
10         JFrame frame = new DisplayImage();
11         frame.setTitle("DisplayImage");
12         frame.setSize(300, 300);
13         frame.setLocationRelativeTo(null); // Center the frame
14         frame.setDefaultCloseOperation(JFrame.EXIT_ON_CLOSE);
15         frame.setVisible(true);
16     }
17 }
18
19 class ImagePanel extends JPanel {
20     private ImageIcon imageIcon = new ImageIcon("image/us.gif");   panel class
21     private Image image = imageIcon.getImage();                     create image icon
22                                                                    get image
23
24     @Override /** Draw image on the panel */
25     protected void paintComponent(Graphics g) {                   override paintComponent
26         super.paintComponent(g);
27
28         if (image != null)
29             g.drawImage(image, 0, 0, getWidth(), getHeight(), this);   draw image
30     }
```

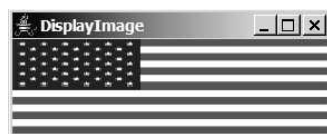


FIGURE 13.23 An image is displayed in a panel.

13.11 Case Study: The `ImageViewer` Class



This case study develops the `ImageViewer` class for displaying an image in a panel.

Displaying an image is a common task in Java programming. This case study develops a reusable component named `ImageViewer` that displays an image on a panel. The class contains the properties `image`, `stretched`, `xCoordinate`, and `yCoordinate`, with associated accessor and mutator methods, as shown in Figure 13.24.

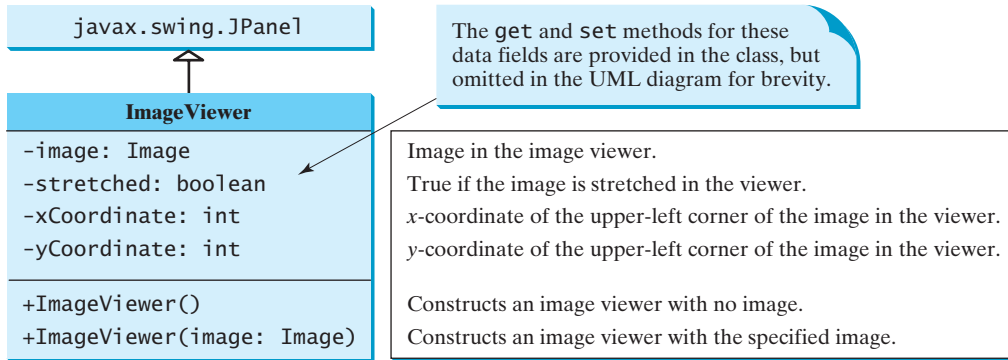


FIGURE 13.24 The `ImageViewer` class displays an image on a panel.

You can use images in Swing components such as `JLabel` and `JButton`, but these images are not stretchable. The image in an `ImageViewer` can be stretched.

stretchable image

Let us write a test program in Listing 13.12 that displays six images using the `ImageViewer` class. Figure 13.25 shows a sample run of the program.

LISTING 13.12 `SixFlags.java`

create image

create image viewer

```

1  import javax.swing.*;
2  import java.awt.*;
3
4  public class SixFlags extends JFrame {
5      public SixFlags() {
6          Image image1 = new ImageIcon("image/us.gif").getImage();
7          Image image2 = new ImageIcon("image/ca.gif").getImage();
8          Image image3 = new ImageIcon("image/india.gif").getImage();
9          Image image4 = new ImageIcon("image/uk.gif").getImage();
10         Image image5 = new ImageIcon("image/china.gif").getImage();
11         Image image6 = new ImageIcon("image/norway.gif").getImage();
12
13         setLayout(new GridLayout(2, 0, 5, 5));
14         add(new ImageViewer(image1));
15         add(new ImageViewer(image2));
16         add(new ImageViewer(image3));
17         add(new ImageViewer(image4));
18         add(new ImageViewer(image5));
19         add(new ImageViewer(image6));
20     }
21
22     public static void main(String[] args) {
23         SixFlags frame = new SixFlags();
24         frame.setTitle("SixFlags");
25         frame.setSize(400, 320);
26         frame.setLocationRelativeTo(null); // Center the frame
  
```

```

27     frame.setDefaultCloseOperation(JFrame.EXIT_ON_CLOSE);
28     frame.setVisible(true);
29 }
30 }

```

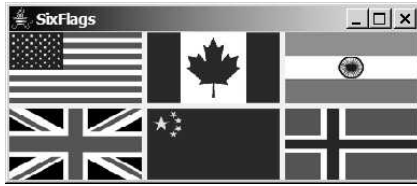


FIGURE 13.25 Six images are displayed in six **ImageViewer** components.

The **ImageViewer** class is implemented in Listing 13.13. (Note: You may skip the implementation.) The accessor and mutator methods for the properties **image**, **stretched**, **xCoordinate**, and **yCoordinate** are easy to implement. The **paintComponent** method (lines 27–36) displays the image on the panel. Line 30 ensures that the image is not **null** before displaying it. Line 31 checks whether the image is stretched or not.

implementation
skip implementation?

LISTING 13.13 **ImageViewer.java**

```

1  import java.awt.*;
2  import javax.swing.*;
3
4  public class ImageViewer extends JPanel {
5      /** Hold value of property image */
6      private java.awt.Image image;           properties
7
8      /** Hold value of property stretched */
9      private boolean stretched = true;
10
11     /** Hold value of property xCoordinate */
12     private int xCoordinate;
13
14     /** Hold value of property yCoordinate */
15     private int yCoordinate;
16
17     /** Construct an empty image viewer */
18     public ImageViewer() {                  constructor
19     }
20
21     /** Construct an image viewer for a specified Image object */
22     public ImageViewer(Image image) {       constructor
23         this.image = image;
24     }
25
26     @Override
27     protected void paintComponent(Graphics g) {
28         super.paintComponent(g);
29
30         if (image != null)                 image null?
31             if (isStretched())             stretched
32                 g.drawImage(image, xCoordinate, yCoordinate,
33                     getWidth(), getHeight(), this);
34         else
35             g.drawImage(image, xCoordinate, yCoordinate, this);   nonstretched
36     }

```

```

37
38  /** Return value of property image */
39  public java.awt.Image getImage() {
40      return image;
41  }
42
43  /** Set a new value for property image */
44  public void setImage(java.awt.Image image) {
45      this.image = image;
46      repaint();
47  }
48
49  /** Return value of property stretched */
50  public boolean isStretched() {
51      return stretched;
52  }
53
54  /** Set a new value for property stretched */
55  public void setStretched(boolean stretched) {
56      this.stretched = stretched;
57      repaint();
58  }
59
60  /** Return value of property xCoordinate */
61  public int getXCoordinate() {
62      return xCoordinate;
63  }
64
65  /** Set a new value for property xCoordinate */
66  public void setXCoordinate(int xCoordinate) {
67      this.xCoordinate = xCoordinate;
68      repaint();
69  }
70
71  /** Return value of property yCoordinate */
72  public int getYCoordinate() {
73      return yCoordinate;
74  }
75
76  /** Set a new value for property yCoordinate */
77  public void setYCoordinate(int yCoordinate) {
78      this.yCoordinate = yCoordinate;
79      repaint();
80  }
81  }

```



MyProgrammingLab™

- 13.23** How do you create an `Image` object from the `ImageIcon` object?
- 13.24** How do you create an `ImageIcon` object from an `Image` object?
- 13.25** Describe the `drawImage` method in the `Graphics` class.
- 13.26** Explain the differences between displaying images in a `JLabel` and in a `JPanel`.
- 13.27** Which package contains `ImageIcon`, and which contains `Image`?

CHAPTER SUMMARY

1. Each component has its own coordinate system with the origin (0, 0) at the upper-left corner of the window. In Java, the *x*-coordinate increases to the right, and the *y*-coordinate increases downward.

2. Whenever a component (e.g., a button, a label, or a panel) is displayed, the JVM automatically creates a **Graphics** object for the component on the native platform and passes this object to invoke the **paintComponent** method to display the drawings.
3. Normally you use **JPanel** as a canvas. To draw on a **JPanel**, you create a new class that extends **JPanel** and overrides the **paintComponent** method to tell the panel how to draw graphics.
4. Invoking **super.paintComponent(g)** is necessary to ensure that the viewing area is cleared before a new drawing is displayed. The user can request the component to be redisplayed by invoking the **repaint()** method defined in the **Component** class. Invoking **repaint()** causes **paintComponent** to be invoked by the JVM. The user should never invoke **paintComponent** directly. For this reason, the protected visibility is sufficient for **paintComponent**.
5. The **Component** class has the **setBackground**, **setForeground**, and **setFont** methods. These methods are used to set colors and fonts for the entire component. If you want to draw several messages in a panel with different colors and fonts, you have to use the **setColor** and **setFont** methods in the **Graphics** class to set the color and font for the current drawing.
6. **FontMetrics** can be used to compute the exact length and width of a string, which is helpful for measuring the size of a string in order to display it in the right position.
7. To display an image, first create an image icon. You can then use **ImageIcon**'s **getImage()** method to get an **Image** object for the image and draw the image using the **drawImage** method in the **java.awt.Graphics** class.

TEST QUESTIONS

Do the test questions for this chapter online at www.cs.armstrong.edu/liang/intro9e/test.html.

PROGRAMMING EXERCISES

MyProgrammingLab™

Sections 13.2–13.7

- *13.1 (*Display a 3 × 3 grid*) Write a program that displays a 3 × 3 grid, as shown in Figure 13.26a. Use red color for vertical lines and blue for horizontals.
- **13.2 (*Create a custom button class*) Develop a custom button class named **OvalButton** that extends **JButton** and displays the button text inside an oval. Figure 13.26b shows two buttons created using the **OvalButton** class.
- *13.3 (*Display a checkerboard*) Programming Exercise 12.10 displays a checkerboard in which each white and black cell is a **JButton**. Rewrite a program that draws a checkerboard on a **JPanel** using the drawing methods in the **Graphics** class, as shown in Figure 13.26c. Use the **drawRect** method to draw each cell in the checkerboard.
- *13.4 (*Display a multiplication table*) Write a program that displays a multiplication table in a panel using the drawing methods, as shown in Figure 13.27a.

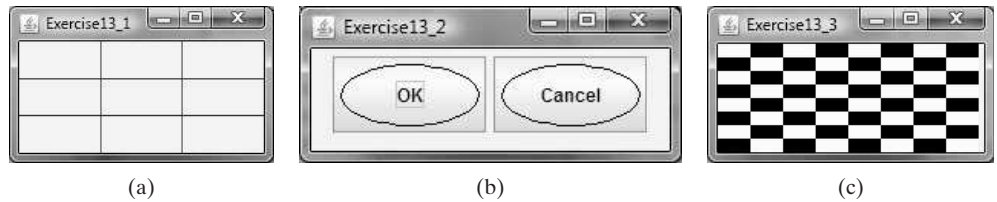


FIGURE 13.26 (a) Exercise 13.1 displays a grid. (b) Exercise 13.2 displays two objects of `OvalButton`. (c) Exercise 13.3 displays a checkerboard.

**** 13.5** (*Display numbers in a triangular pattern*) Write a program that displays numbers in a triangular pattern, as shown in Figure 13.27b. The number of lines in the display changes to fit the window as the window resizes.

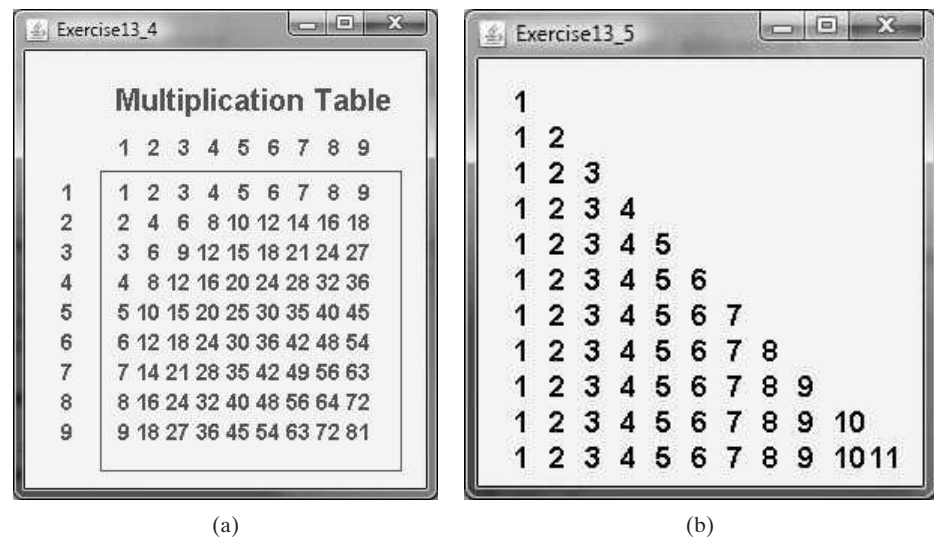


FIGURE 13.27 (a) Exercise 13.4 displays a multiplication table. (b) Exercise 13.5 displays numbers in a triangle formation.

**** 13.6** (*Improve `FigurePanel`*) The `FigurePanel` class in Listing 13.3 can display lines, rectangles, round-cornered rectangles, and ovals. Add appropriate new code in the class to display arcs and polygons. Write a test program to display the shapes as shown in Figure 13.28a using the new `FigurePanel` class.

**** 13.7** (*Display a tic-tac-toe board*) Create a custom panel that displays `X`, `O`, or nothing. What to display is randomly decided whenever a panel is repainted. Use the `Math.random()` method to generate an integer `0`, `1`, or `2`, which corresponds to displaying `X`, `O`, or nothing. Create a frame that contains nine custom panels, as shown in Figure 13.28b.

**** 13.8** (*Draw an octagon*) Write a program that draws an octagon, as shown in Figure 13.28c.

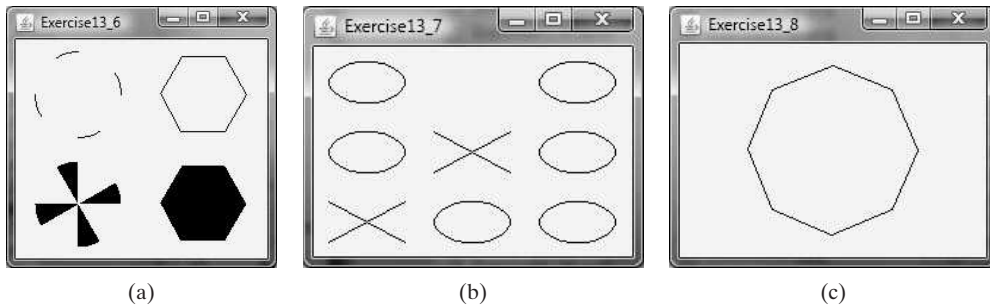


FIGURE 13.28 (a) Four panels of geometric figures are displayed in a frame of **GridLayout**. (b) **TicTacToe** cells randomly display X, O, or nothing. (c) Exercise 13.8 draws an octagon.

***13.9** (*Create four fans*) Write a program that places four fans in a frame of **GridLayout** with two rows and two columns, as shown in Figure 13.29a.

***13.10** (*Display a cylinder*) Write a program that draws a cylinder, as shown in Figure 13.29b.

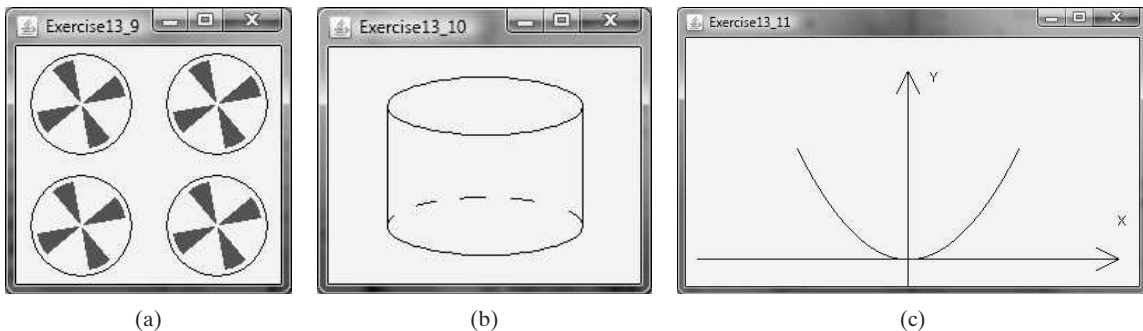


FIGURE 13.29 (a) Exercise 13.9 draws four fans. (b) Exercise 13.10 draws a cylinder. (c) Exercise 13.11 draws a diagram for function $f(x) = x^2$.

***13.11** (*Plot the square function*) Write a program that draws a diagram for the function $f(x) = x^2$ (see Figure 13.29c).

Hint: Add points to a polygon **p** using the following loop:

```
double scaleFactor = 0.1;

for (int x = -100; x <= 100; x++) {
    p.addPoint(x + 200, 200 - (int)(scaleFactor * x * x));
}
```

Connect the points using **g.drawPolyline(p.xpoints, p.ypoints, p.npoints)** for a **Graphics** object **g**. **p.xpoints** returns an array of **x**-coordinates, **p.ypoints** an array of **y**-coordinates, and **p.npoints** the number of points in **Polygon** object **p**.

****13.12** (*Plot the sine and cosine functions*) Write a program that plots the sine function in red and cosine in blue, as shown in Figure 13.30a.



VideoNote

Plot a function

Hint: The Unicode for π is `\u03c0`. To display -2π , use `g.drawString("-2\u03c0", x, y)`. For a trigonometric function like `sin(x)`, x is in radians. Use the following loop to add the points to a polygon `p`:

```
for (int x = -170; x <= 170; x++) {
    p.addPoint(x + 200,
        100 - (int)(50 * Math.sin((x / 100.0) * 2 * Math.PI)));
}
```

-2π is at (100, 100), the center of the axis is at (200, 100), and 2π is at (300, 100). Use the `drawPolyline` method in the `Graphics` class to connect the points.

****13.13** (*Paint a smiley face*) Write a program that paints a smiley face, as shown in Figure 13.30b.

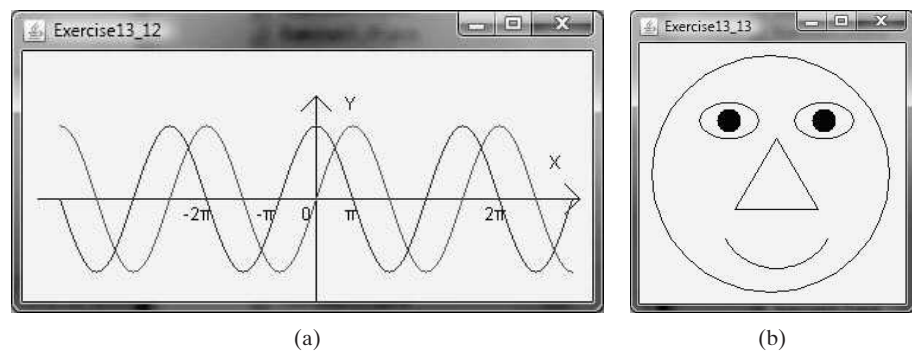


FIGURE 13.30 (a) Exercise 13.12 plots the sine/cosine functions. (b) Exercise 13.13 paints a smiley face.

****13.14** (*Display a bar chart*) Write a program that uses a bar chart to display the percentages of the overall grade represented by projects, quizzes, midterm exams, and the final exam, as shown in Figure 13.1a. Suppose that projects take 20 percent and are displayed in red, quizzes take 10 percent and are displayed in blue, midterm exams take 30 percent and are displayed in green, and the final exam takes 40 percent and is displayed in orange.

****13.15** (*Display a pie chart*) Write a program that uses a pie chart to display the percentages of the overall grade represented by projects, quizzes, midterm exams, and the final exam, as shown in Figure 13.31a. Suppose that projects take 20 percent and are displayed in red, quizzes take 10 percent and are displayed in blue, midterm exams take 30 percent and are displayed in green, and the final exam takes 40 percent and is displayed in orange.

13.16 (*Obtain font information*) Write a program that displays the message **Java is fun** in a panel. Set the panel's font to **TimesRoman, bold, and 20** pixel. Display the font's leading, ascent, descent, height, and the string width as a tool tip text for the panel, as shown in Figure 13.31b.

13.17 (*Game: hangman*) Write a program that displays a drawing for the popular hangman game, as shown in Figure 13.31c.



VideoNote

Plot a bar chart

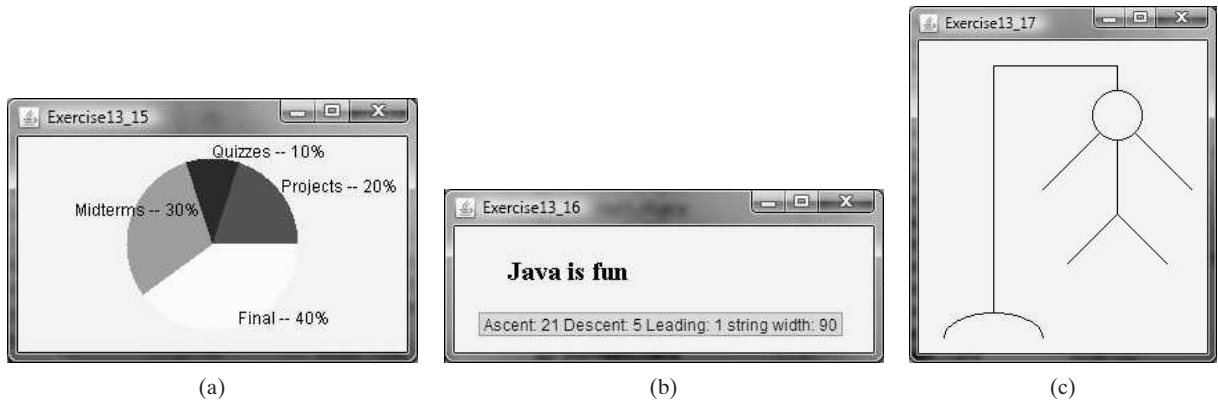


FIGURE 13.31 (a) Exercise 13.15 uses a pie chart to show the percentages of projects, quizzes, midterm exams, and final exam in the overall grade. (b) Exercise 13.16 displays font properties in a tooltip text. (c) Exercise 13.17 draws a sketch for the hangman game.

13.18 (Use the *StillClock* class) Write a program that displays two clocks. The hour, minute, and second values are **4**, **20**, **45** for the first clock and **22**, **46**, **15** for the second clock, as shown in Figure 13.32a.

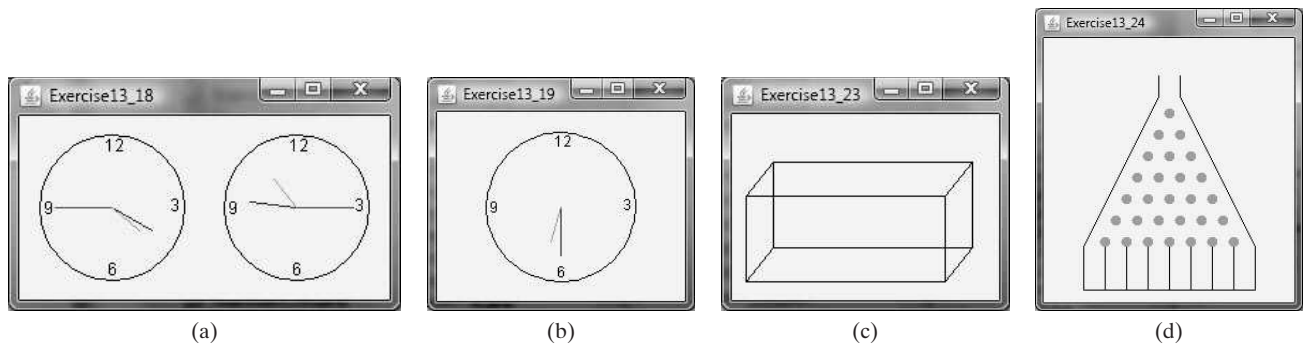


FIGURE 13.32 (a) Exercise 13.18 displays two clocks. (b) Exercise 13.19 displays a clock with random hour and minute values. (c) Exercise 13.23 displays a rectangularoid. (d) Exercise 13.24 simulates a bean machine.

- ***13.19** (*Random time*) Modify the *StillClock* class with three new Boolean properties—**hourHandVisible**, **minuteHandVisible**, and **secondHandVisible**—and their associated accessor and mutator methods. You can use the **set** methods to make a hand visible or invisible. Write a test program that displays only the hour and minute hands. The hour and minute values are randomly generated. The hour is between **0** and **11**, and the minute is either **0** or **30**, as shown in Figure 13.32b.
- ****13.20** (*Draw a detailed clock*) Modify the *StillClock* class in Section 13.9 to draw the clock with more details on the hours and minutes, as shown in Figure 13.1b.
- ****13.21** (*Display a tic-tac-toe board with images*) Rewrite Programming Exercise 12.7 to display an image in a **JPanel** instead of displaying an image icon in a **JLabel**.
- ***13.22** (*Display a STOP sign*) Write a program that displays a STOP sign, as shown in Figure 13.1c. The hexagon is in red and the sign is in white. (*Hint*: See Listing 13.5, *DrawPolygon.java*, and Listing 13.6, *TestCenterMessage.java*.)

- 13.23** (*Display a rectangularoid*) Write a program that displays a rectangularoid, as shown in Figure 13.32c. The cube should grow and shrink as the frame grows or shrinks.
- **13.24** (*Game: bean machine*) Write a program that displays a bean machine introduced in Programming Exercise 6.21. The bean machine should be centered in a resizable panel, as shown in Figure 13.32d.
- **13.25** (*Geometry: display an n -sided regular polygon*) Define a subclass of `JPanel`, named `RegularPolygonPanel`, to paint an n -sided regular polygon. The class contains a property named `numberOfSides`, which specifies the number of sides in the polygon. The polygon is centered in the panel. The size of the polygon is proportional to the size of the panel. Create a pentagon, hexagon, heptagon, octagon, nonagon, and decagon from `RegularPolygonPanel` and display them in a frame, as shown in Figure 13.33a.

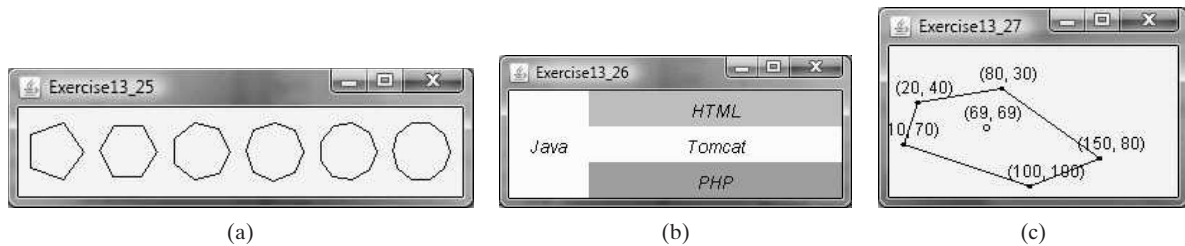


FIGURE 13.33 (a) Exercise 13.25 displays several n -sided polygons. (b) Exercise 13.26 uses `MessagePanel` to display four strings. (c) The polygon and its strategic point are displayed.

Sections 13.8–13.11

- 13.26** (*Use the `MessagePanel` class*) Write a program that displays four messages, as shown in Figure 13.33b.
- **13.27** (*Geometry: strategic point of a polygon*) The strategic point of a polygon is a point inside the polygon that has the shortest total distance to all vertices. Write a program that finds and displays the strategic point, as shown in Figure 13.33c. Your program should pass the coordinates of the polygon's vertices clockwise from the command line as follows:

```
java Exercise13_27 x1 y1 x2 y2 x3 y3 . . .
```

The program displays the polygon and its strategic point in the frame. (*Hint:* To find the strategic point, consider every pixel point inside the polygon to see if it is a strategic point. Use the `contains` method to check whether a point is inside the polygon.)

- **13.28** (*Draw an arrow line*) Write a static method that draws an arrow line from a starting point to an ending point using the following method header:

```
public static void drawArrowLine(int x1, int y1,
    int x2, int y2, Graphics g)
```

Write a test program that randomly draws an arrow line, as shown in Figure 13.34a. Whenever you resize the frame, a new arrow line is drawn.

- *13.29** (*Two circles and their distance*) Write a program that draws two filled circles with radius 15 pixels, centered at random locations, with a line connecting the two circles. The distance between the two centers is displayed on the line, as shown in Figure 13.34b-c. Whenever you resize the frame, the circles are redisplayed in new random locations.

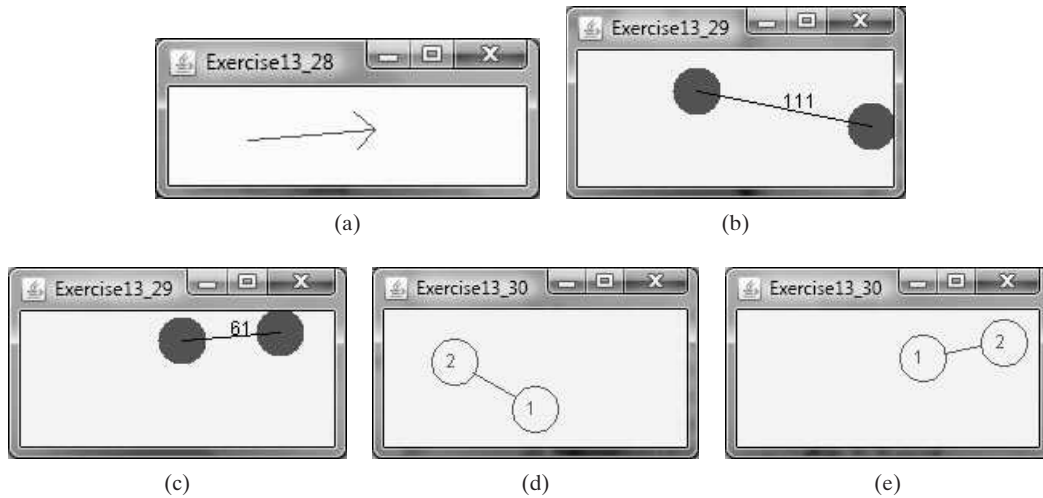


FIGURE 13.34 (a) The program displays an arrow line. (b-c) Exercise13.29 connects the centers of two filled circles. (d-e) Exercise13.30 connects two circles from their perimeter.

***13.30** (*Connect two circles*) Write a program that draws two filled circles with radius **15** pixels, centered at random locations, with a line connecting the two circles. The line should not cross inside the circles, as shown in Figure 13.34d-e. When you resize the frame, the circles are redisplayed in new random locations.

***13.31** (*Geometry: Inside a polygon?*) Write a program that passes the coordinates of five points from the command line as follows:

```
java Exercise13_31 x1 y1 x2 y2 x3 y3 x4 y4 x5 y5
```

The first four points form a polygon, and the program displays the polygon in a panel and a message in a label that indicates whether the fifth point is inside the polygon, as shown in Figure 13.35a.

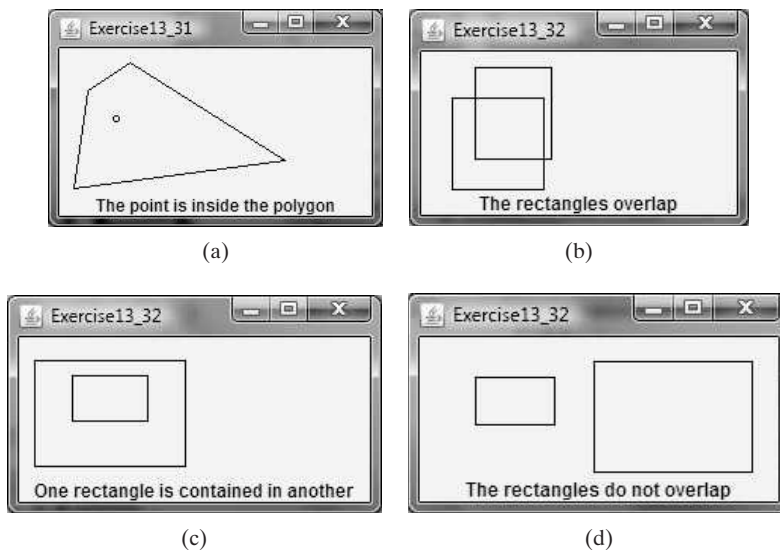


FIGURE 13.35 (a) The polygon and a point are displayed. (b-d) Two rectangles are displayed.

- *13.32** (*Geometry: two rectangles*) Write a program that passes the center coordinates, width, and height of two rectangles from the command line as follows:

```
java Exercise13_32 x1 y1 w1 h1 x2 y2 w2 h2
```

The program displays the rectangles in a panel and a message indicating whether the two are overlapping, whether one is contained in the other, or whether they don't overlap, as shown in Figure 13.35b-d. Display the message in a label. See Programming Exercise 10.13 for checking the relationship between two rectangles.

EXCEPTION HANDLING AND TEXT I/O

Objectives

- To get an overview of exceptions and exception handling (§14.2).
- To explore the advantages of using exception handling (§14.2).
- To distinguish exception types: **Error** (fatal) vs. **Exception** (nonfatal) and checked vs. unchecked (§14.3).
- To declare exceptions in a method header (§14.4.1).
- To throw exceptions in a method (§14.4.2).
- To write a **try-catch** block to handle exceptions (§14.4.3).
- To explain how an exception is propagated (§14.4.3).
- To obtain information from an exception object (§14.4.4).
- To develop applications with exception handling (§14.4.5).
- To use the **finally** clause in a **try-catch** block (§14.5).
- To use exceptions only for unexpected errors (§14.6).
- To rethrow exceptions in a **catch** block (§14.7).
- To create chained exceptions (§14.8).
- To define custom exception classes (§14.9).
- To discover file/directory properties, to delete and rename files/directories, and to create directories using the **File** class (§14.10).
- To write data to a file using the **PrintWriter** class (§14.11.1).
- To read data from a file using the **Scanner** class (§14.11.2).
- To understand how data is read using a **Scanner** (§14.11.3).
- To develop a program that replaces text in a file (§14.11.4).
- To open files using a file dialog box (§14.12).
- To read data from the Web (§14.13).



14.1 Introduction



Exception handling *enables a program to deal with exceptional situations and continue its normal execution.*

Runtime errors occur while a program is running if the JVM detects an operation that is impossible to carry out. For example, if you access an array using an index that is out of bounds, you will get a runtime error with an **ArrayIndexOutOfBoundsException**. If you enter a **double** value when your program expects an integer, you will get a runtime error with an **InputMismatchException**.

exception

In Java, runtime errors are thrown as exceptions. An *exception* is an object that represents an error or a condition that prevents execution from proceeding normally. If the exception is not handled, the program will terminate abnormally. How can you handle the exception so that the program can continue to run or else terminate gracefully? This chapter introduces this subject and text input and output.

14.2 Exception-Handling Overview



Exceptions are thrown from a method. The caller of the method can catch and handle the exception.



VideoNote
Exception-handling
advantages

To demonstrate exception handling, including how an exception object is created and thrown, let's begin with the example in Listing 14.1, which reads in two integers and displays their quotient.

LISTING 14.1 Quotient.java

```

1  import java.util.Scanner;
2
3  public class Quotient {
4      public static void main(String[] args) {
5          Scanner input = new Scanner(System.in);
6
7          // Prompt the user to enter two integers
8          System.out.print("Enter two integers: ");
9          int number1 = input.nextInt();
10         int number2 = input.nextInt();
11
12         System.out.println(number1 + " / " + number2 + " is " +
13             (number1 / number2));
14     }
15 }
```

reads two integers

integer division



```
Enter two integers: 5 2 ↵ Enter
5 / 2 is 2
```



```
Enter two integers: 3 0 ↵ Enter
Exception in thread "main" java.lang.ArithmeticException: / by zero
at Quotient.main(Quotient.java:11)
```

If you entered **0** for the second number, a runtime error would occur, because you cannot divide an integer by **0**. (Recall that a floating-point number divided by **0** does not raise an exception.) A simple way to fix this error is to add an **if** statement to test the second number, as shown in Listing 14.2.

LISTING 14.2 QuotientWithIf.java

```

1  import java.util.Scanner;
2
3  public class QuotientWithIf {
4      public static void main(String[] args) {
5          Scanner input = new Scanner(System.in);
6
7          // Prompt the user to enter two integers
8          System.out.print("Enter two integers: ");
9          int number1 = input.nextInt();           reads two integers
10         int number2 = input.nextInt();
11
12         if (number2 != 0)                         test number2
13             System.out.println(number1 + " / " + number2
14                 + " is " + (number1 / number2));
15         else
16             System.out.println("Divisor cannot be zero ");
17     }
18 }

```

Enter two integers: 5 0
 Divisor cannot be zero



To demonstrate the concept of exception handling, we can rewrite Listing 14.2 to compute a quotient using a method, as shown in Listing 14.3.

LISTING 14.3 QuotientWithMethod.java

```

1  import java.util.Scanner;
2
3  public class QuotientWithMethod {
4      public static int quotient(int number1, int number2) {           quotient method
5          if (number2 == 0) {
6              System.out.println("Divisor cannot be zero");
7              System.exit(1);                                         terminate the program
8          }
9
10         return number1 / number2;
11     }
12
13     public static void main(String[] args) {
14         Scanner input = new Scanner(System.in);
15
16         // Prompt the user to enter two integers
17         System.out.print("Enter two integers: ");
18         int number1 = input.nextInt();                               reads two integers
19         int number2 = input.nextInt();
20
21         int result = quotient(number1, number2);                     invoke method
22         System.out.println(number1 + " / " + number2 + " is "
23             + result);
24     }
25 }

```



```
Enter two integers: 5 3 
5 / 3 is 1
```



```
Enter two integers: 5 0 
Divisor cannot be zero
```

The method `quotient` (lines 4–11) returns the quotient of two integers. If `number2` is `0`, it cannot return a value, so the program is terminated in line 7. This is clearly a problem. You should not let the method terminate the program—the *caller* should decide whether to terminate the program.

How can a method notify its caller an exception has occurred? Java enables a method to throw an exception that can be caught and handled by the caller. Listing 14.3 can be rewritten, as shown in Listing 14.4.

LISTING 14.4 QuotientWithException.java

quotient method

throw exception

reads two integers

try block
invoke method

catch block

```

1  import java.util.Scanner;
2
3  public class QuotientWithException {
4      public static int quotient(int number1, int number2) {
5          if (number2 == 0)
6              throw new ArithmeticException("Divisor cannot be zero");
7
8          return number1 / number2;
9      }
10
11     public static void main(String[] args) {
12         Scanner input = new Scanner(System.in);
13
14         // Prompt the user to enter two integers
15         System.out.print("Enter two integers: ");
16         int number1 = input.nextInt();
17         int number2 = input.nextInt();
18
19         try {
20             int result = quotient(number1, number2);
21             System.out.println(number1 + " / " + number2 + " is "
22                 + result);
23         }
24         catch (ArithmeticException ex) {
25             System.out.println("Exception: an integer " +
26                 "cannot be divided by zero ");
27         }
28
29         System.out.println("Execution continues ...");
30     }
31 }

```



```
Enter two integers: 5 3 
5 / 3 is 1
Execution continues ...
```



```
Enter two integers: 5 0 
Exception: an integer cannot be divided by zero
Execution continues ...
```

If `number2` is `0`, the method throws an exception (line 6) by executing

```
throw new ArithmeticException("Divisor cannot be zero");
```

throw statement

The value thrown, in this case `new ArithmeticException("Divisor cannot be zero")`, is called an *exception*. The execution of a `throw` statement is called *throwing an exception*. The exception is an object created from an exception class. In this case, the exception class is `java.lang.ArithmeticException`. The constructor `ArithmeticException(str)` is invoked to construct an exception object, where `str` is a message that describes the exception.

exception
throwing exception

When an exception is thrown, the normal execution flow is interrupted. As the name suggests, to “throw an exception” is to pass the exception from one place to another. The statement for invoking the method is contained in a `try` block and a `catch` block. The `try` block (lines 19–23) contains the code that is executed in normal circumstances. The exception is caught by the `catch` block. The code in the `catch` block is executed to *handle the exception*. Afterward, the statement (line 29) after the `catch` block is executed.

handle exception

The `throw` statement is analogous to a method call, but instead of calling a method, it calls a `catch` block. In this sense, a `catch` block is like a method definition with a parameter that matches the type of the value being thrown. Unlike a method, however, after the `catch` block is executed, the program control does not return to the `throw` statement; instead, it executes the next statement after the `catch` block.

The identifier `ex` in the `catch`-block header

```
catch (ArithmeticException ex)
```

acts very much like a parameter in a method. Thus, this parameter is referred to as a `catch`-block parameter. The type (e.g., `ArithmeticException`) preceding `ex` specifies what kind of exception the `catch` block can catch. Once the exception is caught, you can access the thrown value from this parameter in the body of a `catch` block.

catch-block parameter

In summary, a template for a `try-throw-catch` block may look like this:

```
try {
    Code to run;
    A statement or a method that may throw an exception;
    More code to run;
}
catch (type ex) {
    Code to process the exception;
}
```

An exception may be thrown directly by using a `throw` statement in a `try` block, or by invoking a method that may throw an exception.

The main method invokes `quotient` (line 20). If the `quotient` method executes normally, it returns a value to the caller. If the `quotient` method encounters an exception, it throws the exception back to its caller. The caller’s `catch` block handles the exception.

Now you can see the *advantage* of using exception handling: It enables a method to throw an exception to its caller, enabling the caller to handle the exception. Without this capability, the called method itself must handle the exception or terminate the program. Often the called method does not know what to do in case of error. This is typically the case for the library methods. The library method can detect the error, but only the caller knows what needs to be

advantage

done when an error occurs. The key benefit of exception handling is separating the detection of an error (done in a called method) from the handling of an error (done in the calling method).

Many library methods throw exceptions. Listing 14.5 gives an example that handles an `InputMismatchException` when reading an input.

LISTING 14.5 `InputMismatchExceptionDemo.java`

```

1  import java.util.*;
2
3  public class InputMismatchExceptionDemo {
4      public static void main(String[] args) {
5          Scanner input = new Scanner(System.in);
6          boolean continueInput = true;
7
8          do {
9              try {
10                 System.out.print("Enter an integer: ");
11                 int number = input.nextInt();
12                 If an InputMismatchException occurs
13                 // Display the result
14                 System.out.println(
15                     "The number entered is " + number);
16
17                 continueInput = false;
18             }
19             catch (InputMismatchException ex) {
20                 System.out.println("Try again. (" +
21                     "Incorrect input: an integer is required)");
22                 input.nextLine(); // Discard input
23             }
24         } while (continueInput);
25     }
26 }

```

create a Scanner

try block

catch block



```

Enter an integer: 3.5 ↵ Enter
Try again. (Incorrect input: an integer is required)
Enter an integer: 4 ↵ Enter
The number entered is 4

```

When executing `input.nextInt()` (line 11), an `InputMismatchException` occurs if the input entered is not an integer. Suppose `3.5` is entered. An `InputMismatchException` occurs and the control is transferred to the `catch` block. The statements in the `catch` block are now executed. The statement `input.nextLine()` in line 22 discards the current input line so that the user can enter a new line of input. The variable `continueInput` controls the loop. Its initial value is `true` (line 6), and it is changed to `false` (line 17) when a valid input is received. Once a valid input is received, there is no need to continue the input.



14.1 What is the advantage of using exception handling?

14.2 Which of the following statements will throw an exception?

```

System.out.println(1 / 0);
System.out.println(1.0 / 0);

```

14.3 Point out the problem in the following code. Does the code throw any exceptions?

```
Long value = Long.MAX_VALUE + 1;
System.out.println(value);
```

14.4 What does the JVM do when an exception occurs? How do you catch an exception?

14.5 What is the printout of the following code?

```
public class Test {
    public static void main(String[] args) {
        try {
            int value = 30;
            if (value < 40)
                throw new Exception("value is too small");
        }
        catch (Exception ex) {
            System.out.println(ex.getMessage());
        }
        System.out.println("Continue after the catch block");
    }
}
```

What would be the printout if the line

```
int value = 30;
```

were changed to

```
int value = 50;
```

14.6 Show the output of the following code.

```
public class Test {
    public static void main(String[] args) {
        for (int i = 0; i < 2; i++) {
            System.out.print(i + " ");
            try {
                System.out.println(1 / 0);
            }
            catch (Exception ex) {
            }
        }
    }
}
```

(a)

```
public class Test {
    public static void main(String[] args) {
        try {
            for (int i = 0; i < 2; i++) {
                System.out.print(i + " ");
                System.out.println(1 / 0);
            }
        }
        catch (Exception ex) {
        }
    }
}
```

(b)

14.3 Exception Types

Exceptions are objects, and objects are defined using classes. The root class for exceptions is `java.lang.Throwable`.



The preceding section used the classes `ArithmeticException` and `InputMismatchException`. Are there any other types of exceptions you can use? Can you define your own exception classes? Yes. There are many predefined exception classes in the Java API. Figure 14.1 shows some of them, and in Section 14.9 you will learn how to define your own exception classes.

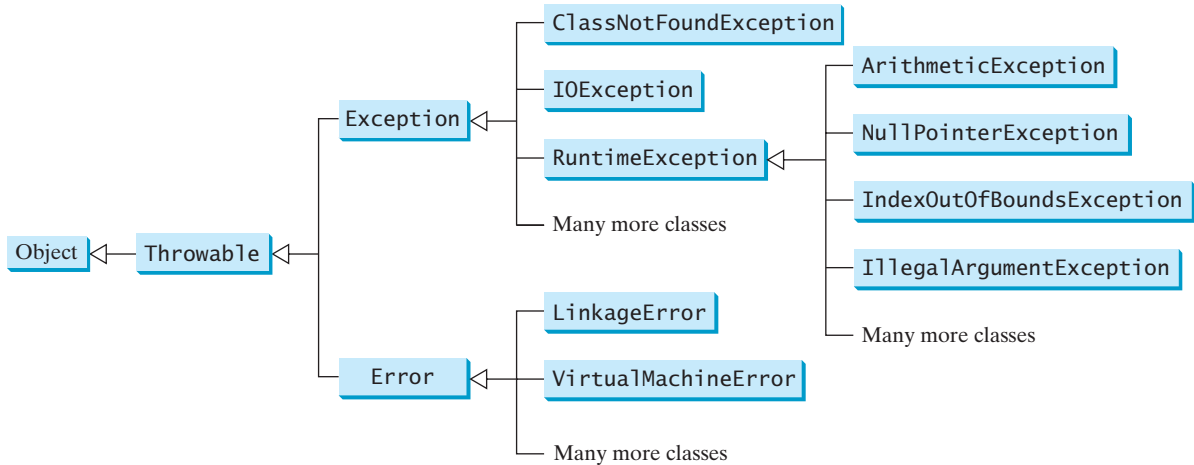


FIGURE 14.1 Exceptions thrown are instances of the classes shown in this diagram, or of subclasses of one of these classes.



Note

The class names **Error**, **Exception**, and **RuntimeException** are somewhat confusing. All three of these classes are exceptions, and all of the errors occur at runtime.

The **Throwable** class is the root of exception classes. All Java exception classes inherit directly or indirectly from **Throwable**. You can create your own exception classes by extending **Exception** or a subclass of **Exception**.

The exception classes can be classified into three major types: system errors, exceptions, and runtime exceptions.

system error

- *System errors* are thrown by the JVM and are represented in the **Error** class. The **Error** class describes internal system errors, though such errors rarely occur. If one does, there is little you can do beyond notifying the user and trying to terminate the program gracefully. Examples of subclasses of **Error** are listed in Table 14.1.

TABLE 14.1 Examples of Subclasses of **Error**

Class	Reasons for Exception
LinkageError	A class has some dependency on another class, but the latter class has changed incompatibly after the compilation of the former class.
VirtualMachineError	The JVM is broken or has run out of the resources it needs in order to continue operating.

exception

- *Exceptions* are represented in the **Exception** class, which describes errors caused by your program and by external circumstances. These errors can be caught and handled by your program. Examples of subclasses of **Exception** are listed in Table 14.2.

TABLE 14.2 Examples of Subclasses of **Exception**

Class	Reasons for Exception
ClassNotFoundException	Attempt to use a class that does not exist. This exception would occur, for example, if you tried to run a nonexistent class using the java command, or if your program were composed of, say, three class files, only two of which could be found.
IOException	Related to input/output operations, such as invalid input, reading past the end of a file, and opening a nonexistent file. Examples of subclasses of IOException are InterruptedIOException , EOFException (EOF is short for End of File), and FileNotFoundException .

- *Runtime exceptions* are represented in the `RuntimeException` class, which describes programming errors, such as bad casting, accessing an out-of-bounds array, and numeric errors. Runtime exceptions are generally thrown by the JVM. Examples of subclasses are listed in Table 14.3. runtime exception

TABLE 14.3 Examples of Subclasses of `RuntimeException`

Class	Reasons for Exception
<code>ArithmeticException</code>	Dividing an integer by zero. Note that floating-point arithmetic does not throw exceptions (see Appendix E, Special Floating-Point Values).
<code>NullPointerException</code>	Attempt to access an object through a <code>null</code> reference variable.
<code>IndexOutOfBoundsException</code>	Index to an array is out of range.
<code>IllegalArgumentException</code>	A method is passed an argument that is illegal or inappropriate.

`RuntimeException`, `Error`, and their subclasses are known as *unchecked exceptions*. All other exceptions are known as *checked exceptions*, meaning that the compiler forces the programmer to check and deal with them in a `try-catch` block or declare it in the method header. Declaring an exception in the method header will be covered in Section 14.4. unchecked exception
checked exception

In most cases, unchecked exceptions reflect programming logic errors that are unrecoverable. For example, a `NullPointerException` is thrown if you access an object through a reference variable before an object is assigned to it; an `IndexOutOfBoundsException` is thrown if you access an element in an array outside the bounds of the array. These are logic errors that should be corrected in the program. Unchecked exceptions can occur anywhere in a program. To avoid cumbersome overuse of `try-catch` blocks, Java does not mandate that you write code to catch or declare unchecked exceptions.



MyProgrammingLab™

14.7 Describe the Java `Throwable` class, its subclasses, and the types of exceptions.

14.8 What `RuntimeException` will the following programs throw, if any?

```
public class Test {
    public static void main(String[] args) {
        System.out.println(1 / 0);
    }
}
```

(a)

```
public class Test {
    public static void main(String[] args) {
        int[] list = new int[5];
        System.out.println(list[5]);
    }
}
```

(b)

```
public class Test {
    public static void main(String[] args) {
        String s = "abc";
        System.out.println(s.charAt(3));
    }
}
```

(c)

```
public class Test {
    public static void main(String[] args) {
        Object o = new Object();
        String d = (String)o;
    }
}
```

(d)

```
public class Test {
    public static void main(String[] args) {
        Object o = null;
        System.out.println(o.toString());
    }
}
```

(e)

```
public class Test {
    public static void main(String[] args) {
        System.out.println(1.0 / 0);
    }
}
```

(f)

14.4 More on Exception Handling



A handler for an exception is found by propagating the exception backward through a chain of method calls, starting from the current method.

The preceding sections gave you an overview of exception handling and introduced several predefined exception types. This section provides an in-depth discussion of exception handling.

Java's exception-handling model is based on three operations: *declaring an exception*, *throwing an exception*, and *catching an exception*, as shown in Figure 14.2.

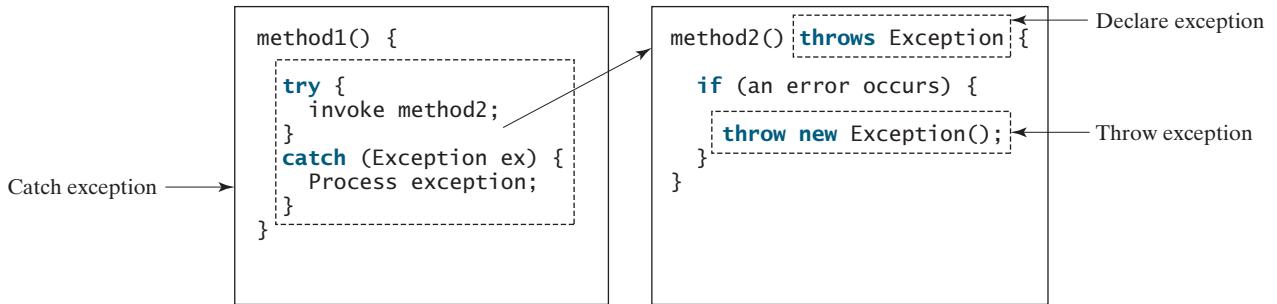


FIGURE 14.2 Exception handling in Java consists of declaring exceptions, throwing exceptions, and catching and processing exceptions.

14.4.1 Declaring Exceptions

In Java, the statement currently being executed belongs to a method. The Java interpreter invokes the `main` method to start executing a program. Every method must state the types of checked exceptions it might throw. This is known as *declaring exceptions*. Because system errors and runtime errors can happen to any code, Java does not require that you declare `Error` and `RuntimeException` (unchecked exceptions) explicitly in the method. However, all other exceptions thrown by the method must be explicitly declared in the method header so that the caller of the method is informed of the exception.

To declare an exception in a method, use the `throws` keyword in the method header, as in this example:

```
public void myMethod() throws IOException
```

The `throws` keyword indicates that `myMethod` might throw an `IOException`. If the method might throw multiple exceptions, add a list of the exceptions, separated by commas, after `throws`:

```
public void myMethod()
    throws Exception1, Exception2, ..., ExceptionN
```



Note

If a method does not declare exceptions in the superclass, you cannot override it to declare exceptions in the subclass.

14.4.2 Throwing Exceptions

A program that detects an error can create an instance of an appropriate exception type and throw it. This is known as *throwing an exception*. Here is an example: Suppose the program detects that an argument passed to the method violates the method contract (e.g., the argument

declare exception

throw exception

must be nonnegative, but a negative argument is passed); the program can create an instance of `IllegalArgumentException` and throw it, as follows:

```
IllegalArgumentException ex =
    new IllegalArgumentException("Wrong Argument");
throw ex;
```

Or, if you prefer, you can use the following:

```
throw new IllegalArgumentException("Wrong Argument");
```



Note

`IllegalArgumentException` is an exception class in the Java API. In general, each exception class in the Java API has at least two constructors: a no-arg constructor, and a constructor with a `String` argument that describes the exception. This argument is called the *exception message*, which can be obtained using `getMessage()`.

exception message



Tip

The keyword to declare an exception is `throws`, and the keyword to throw an exception is `throw`.

throws vs. throw

14.4.3 Catching Exceptions

You now know how to declare an exception and how to throw an exception. When an exception is thrown, it can be caught and handled in a `try-catch` block, as follows:

catch exception

```
try {
    statements; // Statements that may throw exceptions
}
catch (Exception1 exVar1) {
    handler for exception1;
}
catch (Exception2 exVar2) {
    handler for exception2;
}
...
catch (ExceptionN exVar3) {
    handler for exceptionN;
}
```

If no exceptions arise during the execution of the `try` block, the `catch` blocks are skipped.

If one of the statements inside the `try` block throws an exception, Java skips the remaining statements in the `try` block and starts the process of finding the code to handle the exception. The code that handles the exception is called the *exception handler*; it is found by *propagating the exception* backward through a chain of method calls, starting from the current method. Each `catch` block is examined in turn, from first to last, to see whether the type of the exception object is an instance of the exception class in the `catch` block. If so, the exception object is assigned to the variable declared, and the code in the `catch` block is executed. If no handler is found, Java exits this method, passes the exception to the method that invoked the method, and continues the same process to find a handler. If no handler is found in the chain of methods being invoked, the program terminates and prints an error message on the console. The process of finding a handler is called *catching an exception*.

exception handler
exception propagation

Suppose the `main` method invokes `method1`, `method1` invokes `method2`, `method2` invokes `method3`, and `method3` throws an exception, as shown in Figure 14.3. Consider the following scenario:

- If the exception type is `Exception3`, it is caught by the `catch` block for handling exception `ex3` in `method2`. `statement5` is skipped, and `statement6` is executed.
- If the exception type is `Exception2`, `method2` is aborted, the control is returned to `method1`, and the exception is caught by the `catch` block for handling exception `ex2` in `method1`. `statement3` is skipped, and `statement4` is executed.
- If the exception type is `Exception1`, `method1` is aborted, the control is returned to the `main` method, and the exception is caught by the `catch` block for handling exception `ex1` in the `main` method. `statement1` is skipped, and `statement2` is executed.
- If the exception type is not caught in `method2`, `method1`, or `main`, the program terminates, and `statement1` and `statement2` are not executed.

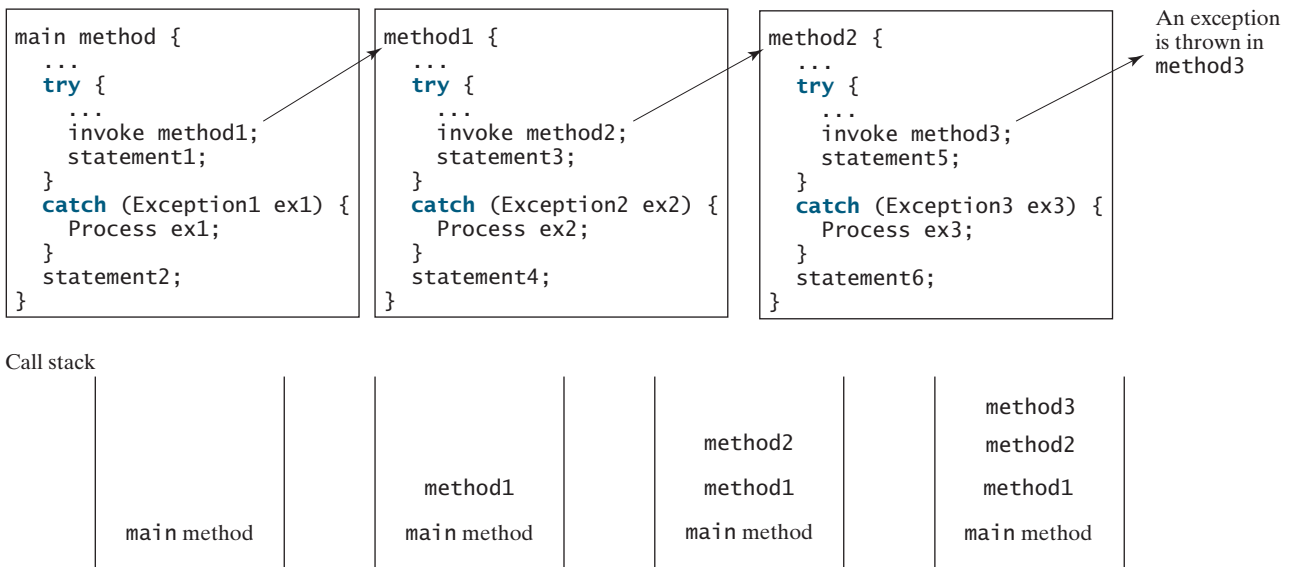




FIGURE 14.3 If an exception is not caught in the current method, it is passed to its caller. The process is repeated until the exception is caught or passed to the `main` method.

catch block  **Note** Various exception classes can be derived from a common superclass. If a `catch` block catches exception objects of a superclass, it can catch all the exception objects of the subclasses of that superclass.

order of exception handlers  **Note** The order in which exceptions are specified in `catch` blocks is important. A compile error will result if a catch block for a superclass type appears before a catch block for a subclass type. For example, the ordering in (a) on the next page is erroneous, because `RuntimeException` is a subclass of `Exception`. The correct ordering should be as shown in (b).

```
try {
    ...
}
catch (Exception ex) {
    ...
}
catch (RuntimeException ex) {
    ...
}
```

(a) Wrong order

```
try {
    ...
}
catch (RuntimeException ex) {
    ...
}
catch (Exception ex) {
    ...
}
```

(b) Correct order



Note

Java forces you to deal with checked exceptions. If a method declares a checked exception (i.e., an exception other than **Error** or **RuntimeException**), you must invoke it in a **try-catch** block or declare to throw the exception in the calling method. For example, suppose that method **p1** invokes method **p2**, and **p2** may throw a checked exception (e.g., **IOException**); you have to write the code as shown in (a) or (b) below.

catch or declare checked exceptions

```
void p1() {
    try {
        p2();
    }
    catch (IOException ex) {
        ...
    }
}
```

(a) Catch exception

```
void p1() throws IOException {
    p2();
}
```

(b) Throw exception



Note

You can use the new JDK 7 multi-catch feature to simplify coding for the exceptions with the same handling code. The syntax is:

JDK 7 multi-catch

```
catch (Exception1 | Exception2 | ... | Exceptionk ex) {
    // Code to handle exceptions
}
```

Each exception type is separated from the next with a vertical bar (**|**). If one of the exceptions is caught, the handling code is executed.

14.4.4 Getting Information from Exceptions

An exception object contains valuable information about the exception. You may use the following instance methods in the **java.lang.Throwable** class to get information regarding the exception, as shown in Figure 14.4. The **printStackTrace()** method prints stack trace

methods in Throwable

java.lang.Throwable	
+getMessage(): String	Returns the message that describes this exception object.
+toString(): String	Returns the concatenation of three strings: (1) the full name of the exception class; (2) " ": (a colon and a space); (3) the getMessage() method.
+printStackTrace(): void	Prints the Throwable object and its call stack trace information on the console.
+getStackTrace(): StackTraceElement[]	Returns an array of stack trace elements representing the stack trace pertaining to this exception object.

FIGURE 14.4 **Throwable** is the root class for all exception objects.

information on the console. The `getStackTrace()` method provides programmatic access to the stack trace information printed by `printStackTrace()`.

Listing 14.6 gives an example that uses the methods in `Throwable` to display exception information. Line 4 invokes the `sum` method to return the sum of all the elements in the array. There is an error in line 23 that causes the `ArrayIndexOutOfBoundsException`, a subclass of `IndexOutOfBoundsException`. This exception is caught in the `try-catch` block. Lines 7, 8, and 9 display the stack trace, exception message, and exception object and message using the `printStackTrace()`, `getMessage()`, and `toString()` methods, as shown in Figure 14.5. Line 12 brings stack trace elements into an array. Each element represents a method call. You can obtain the method (line 14), class name (line 15), and exception line number (line 16) for each element.

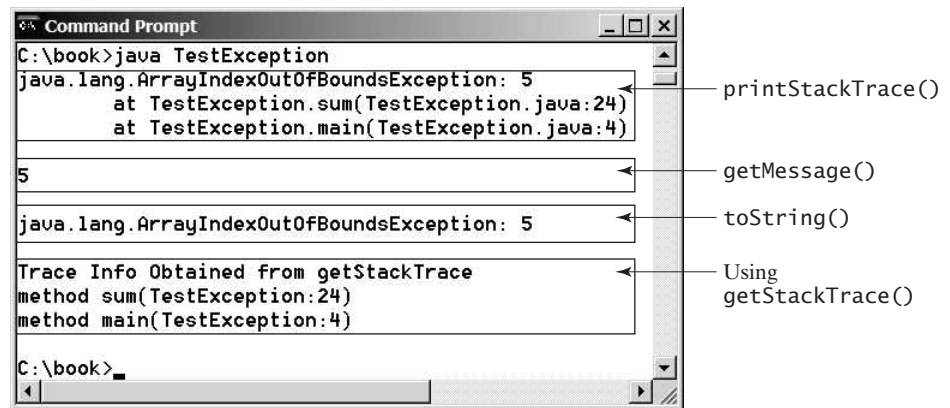


FIGURE 14.5 You can use the `printStackTrace()`, `getMessage()`, `toString()`, and `getStackTrace()` methods to obtain information from exception objects.

LISTING 14.6 TestException.java

```

1  public class TestException {
2      public static void main(String[] args) {
3          try {
4              System.out.println(sum(new int[] {1, 2, 3, 4, 5}));
5          }
6          catch (Exception ex) {
7              ex.printStackTrace();
8              System.out.println("\n" + ex.getMessage());
9              System.out.println("\n" + ex.toString());
10
11             System.out.println("\nTrace Info Obtained from getStackTrace");
12             StackTraceElement[] traceElements = ex.getStackTrace();
13             for (int i = 0; i < traceElements.length; i++) {
14                 System.out.print("method " + traceElements[i].getMethodName());
15                 System.out.print("(" + traceElements[i].getClassName() + ":");
16                 System.out.println(traceElements[i].getLineNumber() + ")");
17             }
18         }
19     }
20
21     private static int sum(int[] list) {
22         int result = 0;
23         for (int i = 0; i <= list.length; i++)

```

Annotations on the left side of the code block:

- `invoke sum` points to line 4.
- `printStackTrace()` points to line 7.
- `getMessage()` points to line 8.
- `toString()` points to line 9.

```

24     result += list[i];
25     return result;
26 }
27 }

```

14.4.5 Example: Declaring, Throwing, and Catching Exceptions

This example demonstrates declaring, throwing, and catching exceptions by modifying the `setRadius` method in the `Circle` class in Listing 8.9, `CircleWithPrivateDataFields.java`. The new `setRadius` method throws an exception if the radius is negative.

Listing 14.7 defines a new circle class named `CircleWithException`, which is the same as `CircleWithPrivateDataFields` except that the `setRadius(double newRadius)` method throws an `IllegalArgumentException` if the argument `newRadius` is negative.

LISTING 14.7 CircleWithException.java

```

1  public class CircleWithException {
2      /** The radius of the circle */
3      private double radius;
4
5      /** The number of the objects created */
6      private static int numberOfObjects = 0;
7
8      /** Construct a circle with radius 1 */
9      public CircleWithException() {
10         this(1.0);
11     }
12
13     /** Construct a circle with a specified radius */
14     public CircleWithException(double newRadius) {
15         setRadius(newRadius);
16         numberOfObjects++;
17     }
18
19     /** Return radius */
20     public double getRadius() {
21         return radius;
22     }
23
24     /** Set a new radius */
25     public void setRadius(double newRadius)
26         throws IllegalArgumentException {                declare exception
27         if (newRadius >= 0)
28             radius = newRadius;
29         else
30             throw new IllegalArgumentException(          throw exception
31                 "Radius cannot be negative");
32     }
33
34     /** Return numberOfObjects */
35     public static int getNumberOfObjects() {
36         return numberOfObjects;
37     }
38
39     /** Return the area of this circle */
40     public double findArea() {
41         return radius * radius * 3.14159;
42     }
43 }

```

A test program that uses the new `Circle` class is given in Listing 14.8.

LISTING 14.8 TestCircleWithException.java

```

1  public class TestCircleWithException {
2      public static void main(String[] args) {
3          try {
4              CircleWithException c1 = new CircleWithException(5);
5              CircleWithException c2 = new CircleWithException(-5);
6              CircleWithException c3 = new CircleWithException(0);
7          }
8          catch (IllegalArgumentException ex) {
9              System.out.println(ex);
10         }
11
12         System.out.println("Number of objects created: " +
13             CircleWithException.getNumberOfObjects());
14     }
15 }

```



```

java.lang.IllegalArgumentException: Radius cannot be negative
Number of objects created: 1

```

The original `Circle` class remains intact except that the class name is changed to `CircleWithException`, a new constructor `CircleWithException(newRadius)` is added, and the `setRadius` method now declares an exception and throws it if the radius is negative.

The `setRadius` method declares to throw `IllegalArgumentException` in the method header (lines 25–32 in `CircleWithException.java`). The `CircleWithException` class would still compile if the `throws IllegalArgumentException` clause were removed from the method declaration, since it is a subclass of `RuntimeException` and every method can throw `RuntimeException` (an unchecked exception) regardless of whether it is declared in the method header.

The test program creates three `CircleWithException` objects—`c1`, `c2`, and `c3`—to test how to handle exceptions. Invoking `new CircleWithException(-5)` (line 5 in Listing 14.8) causes the `setRadius` method to be invoked, which throws an `IllegalArgumentException`, because the radius is negative. In the `catch` block, the type of the object `ex` is `IllegalArgumentException`, which matches the exception object thrown by the `setRadius` method, so this exception is caught by the `catch` block.

The exception handler prints a short message, `ex.toString()` (line 9 in Listing 14.8), about the exception, using `System.out.println(ex)`.

Note that the execution continues in the event of the exception. If the handlers had not caught the exception, the program would have abruptly terminated.

The test program would still compile if the `try` statement were not used, because the method throws an instance of `IllegalArgumentException`, a subclass of `RuntimeException` (an unchecked exception). If a method throws an exception other than `RuntimeException` or `Error`, the method must be invoked within a `try-catch` block.



MyProgrammingLab™

- 14.9** What is the purpose of declaring exceptions? How do you declare an exception, and where? Can you declare multiple exceptions in a method header?
- 14.10** What is a checked exception, and what is an unchecked exception?
- 14.11** How do you throw an exception? Can you throw multiple exceptions in one `throw` statement?
- 14.12** What is the keyword `throw` used for? What is the keyword `throws` used for?

14.13 Suppose that `statement2` causes an exception in the following `try-catch` block:

```
try {
    statement1;
    statement2;
    statement3;
}
catch (Exception1 ex1) {
}
catch (Exception2 ex2) {
}

statement4;
```

Answer the following questions:

- Will `statement3` be executed?
- If the exception is not caught, will `statement4` be executed?
- If the exception is caught in the `catch` block, will `statement4` be executed?

14.14 What is displayed when the following program is run?

```
public class Test {
    public static void main(String[] args) {
        try {
            int[] list = new int[10];
            System.out.println("list[10] is " + list[10]);
        }
        catch (ArithmeticException ex) {
            System.out.println("ArithmeticException");
        }
        catch (RuntimeException ex) {
            System.out.println("RuntimeException");
        }
        catch (Exception ex) {
            System.out.println("Exception");
        }
    }
}
```

14.15 What is displayed when the following program is run?

```
public class Test {
    public static void main(String[] args) {
        try {
            method();
            System.out.println("After the method call");
        }
        catch (ArithmeticException ex) {
            System.out.println("ArithmeticException");
        }
        catch (RuntimeException ex) {
            System.out.println("RuntimeException");
        }
        catch (Exception e) {
            System.out.println("Exception");
        }
    }

    static void method() throws Exception {
```

```

        System.out.println(1 / 0);
    }
}

```

14.16 What is displayed when the following program is run?

```

public class Test {
    public static void main(String[] args) {
        try {
            method();
            System.out.println("After the method call");
        }
        catch (RuntimeException ex) {
            System.out.println("RuntimeException in main");
        }
        catch (Exception ex) {
            System.out.println("Exception in main");
        }
    }

    static void method() throws Exception {
        try {
            String s = "abc";
            System.out.println(s.charAt(3));
        }
        catch (RuntimeException ex) {
            System.out.println("RuntimeException in method()");
        }
        catch (Exception ex) {
            System.out.println("Exception in method()");
        }
    }
}

```

14.17 What does the method `getMessage()` do?

14.18 What does the method `printStackTrace` do?

14.19 Does the presence of a `try-catch` block impose overhead when no exception occurs?

14.20 Correct a compile error in the following code:

```

public void m(int value) {
    if (value < 40)
        throw new Exception("value is too small");
}

```

14.5 The `finally` Clause



The `finally` clause is always executed regardless whether an exception occurred or not.

Occasionally, you may want some code to be executed regardless of whether an exception occurs or is caught. Java has a `finally` clause that can be used to accomplish this objective. The syntax for the `finally` clause might look like this:

```

try {
    statements;
}
catch (TheException ex) {
    handling ex;
}

```

```
finally {
    finalStatements;
}
```

The code in the **finally** block is executed under all circumstances, regardless of whether an exception occurs in the **try** block or is caught. Consider three possible cases:

- If no exception arises in the **try** block, **finalStatements** is executed, and the next statement after the **try** statement is executed.
- If a statement causes an exception in the **try** block that is caught in a **catch** block, the rest of the statements in the **try** block are skipped, the **catch** block is executed, and the **finally** clause is executed. The next statement after the **try** statement is executed.
- If one of the statements causes an exception that is not caught in any **catch** block, the other statements in the **try** block are skipped, the **finally** clause is executed, and the exception is passed to the caller of this method.

The **finally** block executes even if there is a **return** statement prior to reaching the **finally** block.



Note

The **catch** block may be omitted when the **finally** clause is used.

A common use of the **finally** clause is in I/O programming. To ensure that a file is closed under all circumstances, you may place a file closing statement in the **finally** block. Text I/O will be introduced later in this chapter.

omitting catch block

14.21 Suppose that **statement2** causes an exception in the following statement:

```
try {
    statement1;
    statement2;
    statement3;
}
catch (Exception1 ex1) {
}
finally {
    statement4;
}
statement5;
```

Answer the following questions:

- If no exception occurs, will **statement4** be executed, and will **statement5** be executed?
- If the exception is of type **Exception1**, will **statement4** be executed, and will **statement5** be executed?
- If the exception is not of type **Exception1**, will **statement4** be executed, and will **statement5** be executed?



14.6 When to Use Exceptions

A method should throw an exception if the error needs to be handled by its caller.

The **try** block contains the code that is executed in normal circumstances. The **catch** block contains the code that is executed in exceptional circumstances. Exception handling separates error-handling code from normal programming tasks, thus making programs easier to read



and to modify. Be aware, however, that exception handling usually requires more time and resources, because it requires instantiating a new exception object, rolling back the call stack, and propagating the exception through the chain of methods invoked to search for the handler.

An exception occurs in a method. If you want the exception to be processed by its caller, you should create an exception object and throw it. If you can handle the exception in the method where it occurs, there is no need to throw or use exceptions.

In general, common exceptions that may occur in multiple classes in a project are candidates for exception classes. Simple errors that may occur in individual methods are best handled without throwing exceptions. This can be done by using **if** statements to check for errors.

When should you use a **try-catch** block in the code? Use it when you have to deal with unexpected error conditions. Do not use a **try-catch** block to deal with simple, expected situations. For example, the following code

```
try {
    System.out.println(refVar.toString());
}
catch (NullPointerException ex) {
    System.out.println("refVar is null");
}
```

is better replaced by

```
if (refVar != null)
    System.out.println(refVar.toString());
else
    System.out.println("refVar is null");
```

Which situations are exceptional and which are expected is sometimes difficult to decide. The point is not to abuse exception handling as a way to deal with a simple logic test.



14.22 The following method checks whether a string is a numeric string:

```
public static boolean isNumeric(String token) {
    try {
        Double.parseDouble(token);
        return true;
    }
    catch (java.lang.NumberFormatException ex) {
        return false;
    }
}
```

Is it correct? Rewrite it without using exceptions.

MyProgrammingLab™

14.7 Rethrowing Exceptions



Java allows an exception handler to rethrow the exception if the handler cannot process the exception or simply wants to let its caller be notified of the exception.

The syntax for rethrowing an exception may look like this:

```
try {
    statements;
}
catch (TheException ex) {
```

```

perform operations before exits;
throw ex;
}

```

The statement `throw ex` rethrows the exception to the caller so that other handlers in the caller get a chance to process the exception `ex`.

14.23 Suppose that `statement2` causes an exception in the following statement:

```

try {
    statement1;
    statement2;
    statement3;
}
catch (Exception1 ex1) {
}
catch (Exception2 ex2) {
    throw ex2;
}
finally {
    statement4;
}
statement5;

```

Answer the following questions:

- If no exception occurs, will `statement4` be executed, and will `statement5` be executed?
- If the exception is of type `Exception1`, will `statement4` be executed, and will `statement5` be executed?
- If the exception is of type `Exception2`, will `statement4` be executed, and will `statement5` be executed?
- If the exception is not `Exception1` nor `Exception2`, will `statement4` be executed, and will `statement5` be executed?



14.8 Chained Exceptions

Throwing an exception along with another exception forms a chained exception.

In the preceding section, the `catch` block rethrows the original exception. Sometimes, you may need to throw a new exception (with additional information) along with the original exception. This is called *chained exceptions*. Listing 14.9 illustrates how to create and throw chained exceptions.



chained exception

LISTING 14.9 ChainedExceptionDemo.java

```

1 public class ChainedExceptionDemo {
2     public static void main(String[] args) {
3         try {
4             method1();
5         }
6         catch (Exception ex) {
7             ex.printStackTrace();
8         }
9     }
10

```

stack trace

```

11  public static void method1() throws Exception {
12      try {
13          method2();
14      }
15      catch (Exception ex) {
16          throw new Exception("New info from method1", ex);
17      }
18  }
19
20  public static void method2() throws Exception {
21      throw new Exception("New info from method2");
22  }
23  }

```

chained exception

throw exception



```

java.lang.Exception: New info from method1
  at ChainedExceptionDemo.method1(ChainedExceptionDemo.java:16)
  at ChainedExceptionDemo.main(ChainedExceptionDemo.java:4)
Caused by: java.lang.Exception: New info from method2
  at ChainedExceptionDemo.method2(ChainedExceptionDemo.java:21)
  at ChainedExceptionDemo.method1(ChainedExceptionDemo.java:13)
  ... 1 more

```

The `main` method invokes `method1` (line 4), `method1` invokes `method2` (line 13), and `method2` throws an exception (line 21). This exception is caught in the `catch` block in `method1` and is wrapped in a new exception in line 16. The new exception is thrown and caught in the catch block in the `main` method in line 6. The sample output shows the output from the `printStackTrace()` method in line 7. The new exception thrown from `method1` is displayed first, followed by the original exception thrown from `method2`.

14.9 Defining Custom Exception Classes

You can define a custom exception class by extending the `java.lang.Exception` class.



Key
Point



VideoNote

Create custom exception
classes

Java provides quite a few exception classes. Use them whenever possible instead of defining your own exception classes. However, if you run into a problem that cannot be adequately described by the predefined exception classes, you can create your own exception class, derived from `Exception` or from a subclass of `Exception`, such as `IOException`.

In Listing 14.7, `CircleWithException.java`, the `setRadius` method throws an exception if the radius is negative. Suppose you wish to pass the radius to the handler. In that case, you can define a custom exception class, as shown in Listing 14.10.

LISTING 14.10 `InvalidRadiusException.java`

extends `Exception`

```

1  public class InvalidRadiusException extends Exception {
2      private double radius;
3
4      /** Construct an exception */
5      public InvalidRadiusException(double radius) {
6          super("Invalid radius " + radius);
7          this.radius = radius;
8      }
9
10     /** Return the radius */
11     public double getRadius() {
12         return radius;
13     }
14 }

```

This custom exception class extends `java.lang.Exception` (line 1). The `Exception` class extends `java.lang.Throwable`. All the methods (e.g., `getMessage()`, `toString()`, and `printStackTrace()`) in `Exception` are inherited from `Throwable`. The `Exception` class contains four constructors. Among them, the following two constructors are often used:

<code>java.lang.Exception</code>	
<code>+Exception()</code>	Constructs an exception with no message.
<code>+Exception(message: String)</code>	Constructs an exception with the specified message.

Line 6 invokes the superclass's constructor with a message. This message will be set in the exception object and can be obtained by invoking `getMessage()` on the object.



Tip

Most exception classes in the Java API contain two constructors: a no-arg constructor and a constructor with a message parameter.

To create an `InvalidRadiusException`, you have to pass a radius. Therefore, the `setRadius` method in Listing 14.7 can be modified as shown in Listing 14.11.

LISTING 14.11 `TestCircleWithCustomException.java`

```

1  public class TestCircleWithCustomException {
2      public static void main(String[] args) {
3          try {
4              new CircleWithCustomException(5);
5              new CircleWithCustomException(-5);
6              new CircleWithCustomException(0);
7          }
8          catch (InvalidRadiusException ex) {
9              System.out.println(ex);
10         }
11
12         System.out.println("Number of objects created: " +
13             CircleWithException.getNumberOfObjects());
14     }
15 }
16
17 class CircleWithCustomException {
18     /** The radius of the circle */
19     private double radius;
20
21     /** The number of objects created */
22     private static int numberOfObjects = 0;
23
24     /** Construct a circle with radius 1 */
25     public CircleWithCustomException() throws InvalidRadiusException { declare exception
26         this(1.0);
27     }
28
29     /** Construct a circle with a specified radius */
30     public CircleWithCustomException(double newRadius) throw exception
31         throws InvalidRadiusException {
32         setRadius(newRadius);
33         numberOfObjects++;
34     }
35
36     /** Return radius */

```

```

37     public double getRadius() {
38         return radius;
39     }
40
41     /** Set a new radius */
42     public void setRadius(double newRadius)
43         throws InvalidRadiusException {
44         if (newRadius >= 0)
45             radius = newRadius;
46         else
47             throw new InvalidRadiusException(newRadius);
48     }
49
50     /** Return numberOfObjects */
51     public static int getNumberOfObjects() {
52         return numberOfObjects;
53     }
54
55     /** Return the area of this circle */
56     public double findArea() {
57         return radius * radius * 3.14159;
58     }
59 }

```



```

InvalidRadiusException: Invalid radius -5.0
Number of objects created: 0

```

The `setRadius` method in `CircleWithCustomException` throws an `InvalidRadiusException` when radius is negative (line 47). Since `InvalidRadiusException` is a checked exception, the `setRadius` method must declare it in the method header (line 42). Since the constructors for `CircleWithCustomException` invoke the `setRadius` method to set a new radius and it may throw an `InvalidRadiusException`, the constructors are declared to throw `InvalidRadiusException` (lines 25, 31).

Invoking `new CircleWithCustomException(-5)` throws an `InvalidRadiusException`, which is caught by the handler. The handler displays the radius in the exception object `ex`.

checked custom exception



Tip

Can you define a custom exception class by extending `RuntimeException`? Yes, but it is not a good way to go, because it makes your custom exception unchecked. It is better to make a custom exception checked, so that the compiler can force these exceptions to be caught in your program.



14.24 How do you define a custom exception class?

14.25 Suppose the `setRadius` method throws the `InvalidRadiusException` defined in Listing 14.10. What is displayed when the following program is run?

```

public class Test {
    public static void main(String[] args) {
        try {
            method();
            System.out.println("After the method call");
        }
        catch (RuntimeException ex) {
            System.out.println("RuntimeException in main");
        }
    }
}

```



```

    }
    catch (Exception ex) {
        System.out.println("Exception in main");
    }
}

static void method() throws Exception {
    try {
        Circle c1 = new Circle(1);
        c1.setRadius(-1);
        System.out.println(c1.getRadius());
    }
    catch (RuntimeException ex) {
        System.out.println("RuntimeException in method()");
    }
    catch (Exception ex) {
        System.out.println("Exception in method()");
        throw ex;
    }
}
}
}

```

14.10 The File Class

The **File** class contains the methods for obtaining the properties of a file/directory and for renaming and deleting a file/directory.



Having learned exception handling, you are ready to step into file processing. Data stored in the program are temporary; they are lost when the program terminates. To permanently store the data created in a program, you need to save them in a file on a disk or other permanent storage device. The file can then be transported and read later by other programs. Since data are stored in files, this section introduces how to use the **File** class to obtain file/directory properties, to delete and rename files/directories, and to create directories. The next section introduces how to read/write data from/to text files.

why file?

Every file is placed in a directory in the file system. An *absolute file name* (or *full name*) contains a file name with its complete path and drive letter. For example, **c:\book\Welcome.java** is the absolute file name for the file **Welcome.java** on the Windows operating system. Here **c:\book** is referred to as the *directory path* for the file. Absolute file names are machine dependent. On the UNIX platform, the absolute file name may be **/home/liang/book/Welcome.java**, where **/home/liang/book** is the directory path for the file **Welcome.java**.

absolute file name

directory path

A *relative file name* is in relation to the current working directory. The complete directory path for a relative file name is omitted. For example, **Welcome.java** is a relative file name. If the current working directory is **c:\book**, the absolute file name would be **c:\book\Welcome.java**.

relative file name

The **File** class is intended to provide an abstraction that deals with most of the machine-dependent complexities of files and path names in a machine-independent fashion. The **File** class contains the methods for obtaining file and directory properties and for renaming and deleting files and directories, as shown in Figure 14.6. However, *the File class does not contain the methods for reading and writing file contents.*

The file name is a string. The **File** class is a wrapper class for the file name and its directory path. For example, **new File("c:\\book")** creates a **File** object for the directory **c:\book**, and **new File("c:\\book\\test.dat")** creates a **File** object for the file **c:\book\test.dat**, both on Windows. You can use the **File** class's **isDirectory()** method to check whether the object represents a directory, and the **isFile()** method to check whether the object represents a file.

java.io.File	
+File(pathname: String)	Creates a <code>File</code> object for the specified path name. The path name may be a directory or a file.
+File(parent: String, child: String)	Creates a <code>File</code> object for the child under the directory parent. The child may be a file name or a subdirectory.
+File(parent: File, child: String)	Creates a <code>File</code> object for the child under the directory parent. The parent is a <code>File</code> object. In the preceding constructor, the parent is a string.
+exists(): boolean	Returns true if the file or the directory represented by the <code>File</code> object exists.
+canRead(): boolean	Returns true if the file represented by the <code>File</code> object exists and can be read.
+canWrite(): boolean	Returns true if the file represented by the <code>File</code> object exists and can be written.
+isDirectory(): boolean	Returns true if the <code>File</code> object represents a directory.
+isFile(): boolean	Returns true if the <code>File</code> object represents a file.
+isAbsolute(): boolean	Returns true if the <code>File</code> object is created using an absolute path name.
+isHidden(): boolean	Returns true if the file represented in the <code>File</code> object is hidden. The exact definition of <i>hidden</i> is system-dependent. On Windows, you can mark a file hidden in the File Properties dialog box. On Unix systems, a file is hidden if its name begins with a period(.) character.
+getAbsolutePath(): String	Returns the complete absolute file or directory name represented by the <code>File</code> object.
+getCanonicalPath(): String	Returns the same as <code>getAbsolutePath()</code> except that it removes redundant names, such as "." and "..", from the path name, resolves symbolic links (on Unix), and converts drive letters to standard uppercase (on Windows).
+getName(): String	Returns the last name of the complete directory and file name represented by the <code>File</code> object. For example, new <code>File("c:\\book\\test.dat").getName()</code> returns <code>test.dat</code> .
+getPath(): String	Returns the complete directory and file name represented by the <code>File</code> object. For example, new <code>File("c:\\book\\test.dat").getPath()</code> returns <code>c:\book\test.dat</code> .
+getParent(): String	Returns the complete parent directory of the current directory or the file represented by the <code>File</code> object. For example, new <code>File("c:\\book\\test.dat").getParent()</code> returns <code>c:\book</code> .
+lastModified(): long	Returns the time that the file was last modified.
+length(): long	Returns the size of the file, or 0 if it does not exist or if it is a directory.
+listFile(): File[]	Returns the files under the directory for a directory <code>File</code> object.
+delete(): boolean	Deletes the file or directory represented by this <code>File</code> object. The method returns true if the deletion succeeds.
+renameTo(dest: File): boolean	Renames the file or directory represented by this <code>File</code> object to the specified name represented in <code>dest</code> . The method returns true if the operation succeeds.
+mkdir(): boolean	Creates a directory represented in this <code>File</code> object. Returns true if the the directory is created successfully.
+mkdirs(): boolean	Same as <code>mkdir()</code> except that it creates directory along with its parent directories if the parent directories do not exist.

FIGURE 14.6 The `File` class can be used to obtain file and directory properties, to delete and rename files and directories, and to create directories.

\ in file names



Caution

The directory separator for Windows is a backslash (\). The backslash is a special character in Java and should be written as `\\` in a string literal (see Table 2.6).



Note

Constructing a `File` instance does not create a file on the machine. You can create a `File` instance for any file name regardless whether it exists or not. You can invoke the `exists()` method on a `File` instance to check whether the file exists.

relative file name

Do not use absolute file names in your program. If you use a file name such as `c:\\book\\Welcome.java`, it will work on Windows but not on other platforms. You should use a file name relative to the current directory. For example, you may create a `File` object using `new File("Welcome.java")` for the file `Welcome.java` in the current directory. You may create a `File` object using `new File("image/us.gif")` for the file `us.gif` under the `image` directory in the current directory. The forward slash (/) is the Java directory

Java directory separator (/)

separator, which is the same as on UNIX. The statement `new File("image/us.gif")` works on Windows, UNIX, and any other platform.

Listing 14.12 demonstrates how to create a `File` object and use the methods in the `File` class to obtain its properties. The program creates a `File` object for the file `us.gif`. This file is stored under the `image` directory in the current directory.

LISTING 14.12 TestFileClass.java

```

1 public class TestFileClass {
2     public static void main(String[] args) {
3         java.io.File file = new java.io.File("image/us.gif");
4         System.out.println("Does it exist? " + file.exists());
5         System.out.println("The file has " + file.length() + " bytes");
6         System.out.println("Can it be read? " + file.canRead());
7         System.out.println("Can it be written? " + file.canWrite());
8         System.out.println("Is it a directory? " + file.isDirectory());
9         System.out.println("Is it a file? " + file.isFile());
10        System.out.println("Is it absolute? " + file.isAbsolute());
11        System.out.println("Is it hidden? " + file.isHidden());
12        System.out.println("Absolute path is " +
13            file.getAbsolutePath());
14        System.out.println("Last modified on " +
15            new java.util.Date(file.lastModified()));
16    }
17 }

```

create a File object
 exists()
 length()
 canRead()
 canWrite()
 isDirectory()
 isFile()
 isAbsolute()
 isHidden()
 getAbsolutePath()
 lastModified()

The `lastModified()` method returns the date and time when the file was last modified, measured in milliseconds since the beginning of UNIX time (00:00:00 GMT, January 1, 1970). The `Date` class is used to display it in a readable format in lines 14–15.

Figure 14.7a shows a sample run of the program on Windows, and Figure 14.7b, a sample run on UNIX. As shown in the figures, the path-naming conventions on Windows are different from those on UNIX.

```

C:\book>java TestFileClass
Does it exist? true
The file has 2998 bytes
Can it be read? true
Can it be written? true
Is it a directory? false
Is it a file? true
Is it absolute? false
Is it hidden? false
Absolute path is C:\book\image\us.gif
Last modified on Tue Nov 02 08:20:45 EST 2004
C:\book>

```

(a) On Windows

```

[daniel@panda book]$ java TestFileClass
Does it exist? true
The file has 2998 bytes
Can it be read? true
Can it be written? true
Is it a directory? false
Is it a file? true
Is it absolute? false
Is it hidden? false
Absolute path is /home/daniel/book/image/us.gif
Last modified on Tue Nov 02 08:20:45 EST 2004
[daniel@panda book]$

```

(b) On UNIX

FIGURE 14.7 The program creates a `File` object and displays file properties.

14.26 What is wrong about creating a `File` object using the following statement?

```
new File("c:\book\test.dat");
```

14.27 How do you check whether a file already exists? How do you delete a file? How do you rename a file? Can you find the file size (the number of bytes) using the `File` class? How do you create a directory?

14.28 Can you use the `File` class for I/O? Does creating a `File` object create a file on the disk?

14.11 File Input and Output



Use the `Scanner` class for reading text data from a file and the `PrintWriter` class for writing text data to a file.



VideoNote

Write and read data

A `File` object encapsulates the properties of a file or a path, but it does not contain the methods for creating a file or for writing/reading data to/from a file (referred to as data *input* and *output*, or *I/O* for short). In order to perform I/O, you need to create objects using appropriate Java I/O classes. The objects contain the methods for reading/writing data from/to a file. There are two types of files: text and binary. Text files are essentially strings on disk. This section introduces how to read/write strings and numeric values from/to a text file using the `Scanner` and `PrintWriter` classes. Binary files will be introduced in Chapter 19.

14.11.1 Writing Data Using `PrintWriter`

The `java.io.PrintWriter` class can be used to create a file and write data to a text file. First, you have to create a `PrintWriter` object for a text file as follows:

```
PrintWriter output = new PrintWriter(filename);
```

Then, you can invoke the `print`, `println`, and `printf` methods on the `PrintWriter` object to write data to a file. Figure 14.8 summarizes frequently used methods in `PrintWriter`.

java.io.PrintWriter	
+PrintWriter(file: File)	Creates a <code>PrintWriter</code> object for the specified file object.
+PrintWriter(filename: String)	Creates a <code>PrintWriter</code> object for the specified file-name string.
+print(s: String): void	Writes a string to the file.
+print(c: char): void	Writes a character to the file.
+print(cArray: char[]): void	Writes an array of characters to the file.
+print(i: int): void	Writes an <code>int</code> value to the file.
+print(l: long): void	Writes a <code>long</code> value to the file.
+print(f: float): void	Writes a <code>float</code> value to the file.
+print(d: double): void	Writes a <code>double</code> value to the file.
+print(b: boolean): void	Writes a <code>boolean</code> value to the file.
Also contains the overloaded <code>println</code> methods.	A <code>println</code> method acts like a <code>print</code> method; additionally, it prints a line separator. The line-separator string is defined by the system. It is <code>\r\n</code> on Windows and <code>\n</code> on Unix.
Also contains the overloaded <code>printf</code> methods.	The <code>printf</code> method was introduced in §3.16, “Formatting Console Output.”

FIGURE 14.8 The `PrintWriter` class contains the methods for writing data to a text file.

Listing 14.13 gives an example that creates an instance of `PrintWriter` and writes two lines to the file `scores.txt`. Each line consists of a first name (a string), a middle-name initial (a character), a last name (a string), and a score (an integer).

LISTING 14.13 WriteData.java

```
1 public class WriteData {
2     public static void main(String[] args) throws IOException {
3         java.io.File file = new java.io.File("scores.txt");
4         if (file.exists()) {
```

throws an exception
create `File` object
file exist?

```

5     System.out.println("File already exists");
6     System.exit(1);
7 }
8
9 // Create a file
10 java.io.PrintWriter output = new java.io.PrintWriter(file);           create PrintWriter
11
12 // Write formatted output to the file
13 output.print("John T Smith ");                                       print data
14 output.println(90);
15 output.print("Eric K Jones ");
16 output.println(85);
17
18 // Close the file
19 output.close();                                                       close file
20 }
21 }

```



Lines 4–7 check whether the file `scores.txt` exists. If so, exit the program (line 6).

Invoking the constructor of `PrintWriter` will create a new file if the file does not exist. If the file already exists, the current content in the file will be discarded without verifying with the user. create a file

Invoking the constructor of `PrintWriter` may throw an I/O exception. Java forces you to write the code to deal with this type of exception. For simplicity, we declare `throws IOException` in the main method header (line 2). throws IOException

You have used the `System.out.print`, `System.out.println`, and `System.out.printf` methods to write text to the console. `System.out` is a standard Java object for the console. You can create `PrintWriter` objects for writing text to any file using `print`, `println`, and `printf` (lines 13–16). print method

The `close()` method must be used to close the file. If this method is not invoked, the data may not be saved properly in the file. close file

14.11.2 Reading Data Using `Scanner`

The `java.util.Scanner` class was used to read strings and primitive values from the console in Section 2.3, Reading Input from the Console. A `Scanner` breaks its input into tokens delimited by whitespace characters. To read from the keyboard, you create a `Scanner` for `System.in`, as follows:

```
Scanner input = new Scanner(System.in);
```

To read from a file, create a `Scanner` for a file, as follows:

```
Scanner input = new Scanner(new File(filename));
```

Figure 14.9 summarizes frequently used methods in `Scanner`.

Listing 14.14 gives an example that creates an instance of `Scanner` and reads data from the file `scores.txt`.

LISTING 14.14 `ReadData.java`

```

1 import java.util.Scanner;
2
3 public class ReadData {
4     public static void main(String[] args) throws Exception {
5         // Create a File instance
6         java.io.File file = new java.io.File("scores.txt");           create a file
7
8         // Create a Scanner for the file

```

```

create a Scanner      9      Scanner input = new Scanner(file);
                    10
                    11      // Read data from a file
has next?            12      while (input.hasNext()) {
read items           13          String firstName = input.next();
                    14          String mi = input.next();
                    15          String lastName = input.next();
                    16          int score = input.nextInt();
                    17          System.out.println(
                    18              firstName + " " + mi + " " + lastName + " " + score);
                    19      }
                    20
                    21      // Close the file
close file           22      input.close();
                    23  }
                    24  }

```

scores.txt

John	T	Smith	90
Eric	K	Jones	85

java.util.Scanner	
+Scanner(source: File)	Creates a Scanner that produces values scanned from the specified file.
+Scanner(source: String)	Creates a Scanner that produces values scanned from the specified string.
+close()	Closes this scanner.
+hasNext(): boolean	Returns true if this scanner has more data to be read.
+next(): String	Returns next token as a string from this scanner.
+nextLine(): String	Returns a line ending with the line separator from this scanner.
+nextByte(): byte	Returns next token as a byte from this scanner.
+nextShort(): short	Returns next token as a short from this scanner.
+nextInt(): int	Returns next token as an int from this scanner.
+nextLong(): long	Returns next token as a long from this scanner.
+nextFloat(): float	Returns next token as a float from this scanner.
+nextDouble(): double	Returns next token as a double from this scanner.
+useDelimiter(pattern: String): Scanner	Sets this scanner's delimiting pattern and returns this scanner.

FIGURE 14.9 The **Scanner** class contains the methods for scanning data.

Note that `new Scanner(String)` creates a **Scanner** for a given string. To create a **Scanner** to read data from a file, you have to use the `java.io.File` class to create an instance of the **File** using the constructor `new File(filename)` (line 6), and use `new Scanner(File)` to create a **Scanner** for the file (line 9).

File class

throws Exception

Invoking the constructor `new Scanner(File)` may throw an I/O exception, so the `main` method declares `throws Exception` in line 4.

Each iteration in the `while` loop reads the first name, middle initial, last name, and score from the text file (lines 12–19). The file is closed in line 22.

close file

It is not necessary to close the input file (line 22), but it is a good practice to do so to release the resources occupied by the file.

14.11.3 How Does **Scanner** Work?

token-reading method
change delimiter

The `nextByte()`, `nextShort()`, `nextInt()`, `nextLong()`, `nextFloat()`, `nextDouble()`, and `next()` methods are known as *token-reading methods*, because they read tokens separated by delimiters. By default, the delimiters are whitespace. You can use the `useDelimiter(String regex)` method to set a new pattern for delimiters.

How does an input method work? A token-reading method first skips any delimiters (white-space by default), then reads a token ending at a delimiter. The token is then automatically converted into a value of the `byte`, `short`, `int`, `long`, `float`, or `double` type for `nextByte()`, `nextShort()`, `nextInt()`, `nextLong()`, `nextFloat()`, and `nextDouble()`, respectively. For the `next()` method, no conversion is performed. If the token does not match the expected type, a runtime exception `java.util.InputMismatchException` will be thrown.

Both methods `next()` and `nextLine()` read a string. The `next()` method reads a string delimited by delimiters, and `nextLine()` reads a line ending with a line separator.

`InputMismatchException`
`next()` vs. `nextLine()`



Note

The line-separator string is defined by the system. It is `\r\n` on Windows and `\n` on UNIX. To get the line separator on a particular platform, use

line separator

```
String lineSeparator = System.getProperty("line.separator");
```

If you enter input from a keyboard, a line ends with the *Enter* key, which corresponds to the `\n` character.

The token-reading method does not read the delimiter after the token. If the `nextLine()` method is invoked after a token-reading method, this method reads characters that start from this delimiter and end with the line separator. The line separator is read, but it is not part of the string returned by `nextLine()`.

behavior of `nextLine()`

Suppose a text file named `test.txt` contains a line

input from file

```
34 567
```

After the following code is executed,

```
Scanner input = new Scanner(new File("test.txt"));
int intValue = input.nextInt();
String line = input.nextLine();
```

`intValue` contains `34` and `line` contains the characters `' '`, `5`, `6`, and `7`.

What happens if the input is *entered from the keyboard*? Suppose you enter `34`, press the *Enter* key, then enter `567` and press the *Enter* key for the following code:

input from keyboard

```
Scanner input = new Scanner(System.in);
int intValue = input.nextInt();
String line = input.nextLine();
```

You will get `34` in `intValue` and an empty string in `line`. Why? Here is the reason. The token-reading method `nextInt()` reads in `34` and stops at the delimiter, which in this case is a line separator (the *Enter* key). The `nextLine()` method ends after reading the line separator and returns the string read before the line separator. Since there are no characters before the line separator, `line` is empty.

You can read data from a file or from the keyboard using the `Scanner` class. You can also scan data from a string using the `Scanner` class. For example, the following code

scan a string

```
Scanner input = new Scanner("13 14");
int sum = input.nextInt() + input.nextInt();
System.out.println("Sum is " + sum);
```

displays

```
The sum is 27
```

14.11.4 Case Study: Replacing Text

Suppose you are to write a program named `ReplaceText` that replaces all occurrences of a string in a text file with a new string. The file name and strings are passed as command-line arguments as follows:

```
java ReplaceText sourceFile targetFile oldString newString
```

For example, invoking

```
java ReplaceText FormatString.java t.txt StringBuilder StringBuffer
```

replaces all the occurrences of `StringBuilder` by `StringBuffer` in the file `FormatString.java` and saves the new file in `t.txt`.

Listing 14.15 gives the program. The program checks the number of arguments passed to the `main` method (lines 7–11), checks whether the source and target files exist (lines 14–25), creates a `Scanner` for the source file (line 28), creates a `PrintWriter` for the target file, and repeatedly reads a line from the source file (line 32), replaces the text (line 33), and writes a new line to the target file (line 34). You must close the output file (line 38) to ensure that data are saved to the file properly.

LISTING 14.15 `ReplaceText.java`

```

1  import java.io.*;
2  import java.util.*;
3
4  public class ReplaceText {
5      public static void main(String[] args) throws Exception {
6          // Check command-line parameter usage
7          if (args.length != 4) {
8              System.out.println(
9                  "Usage: java ReplaceText sourceFile targetFile oldStr newStr");
10             System.exit(1);
11         }
12
13         // Check if source file exists
14         File sourceFile = new File(args[0]);
15         if (!sourceFile.exists()) {
16             System.out.println("Source file " + args[0] + " does not exist");
17             System.exit(2);
18         }
19
20         // Check if target file exists
21         File targetFile = new File(args[1]);
22         if (targetFile.exists()) {
23             System.out.println("Target file " + args[1] + " already exists");
24             System.exit(3);
25         }
26
27         // Create a Scanner for input and a PrintWriter for output
28         Scanner input = new Scanner(sourceFile);
29         PrintWriter output = new PrintWriter(targetFile);
30
31         while (input.hasNext()) {
32             String s1 = input.nextLine();
33             String s2 = s1.replaceAll(args[2], args[3]);
34             output.println(s2);
35         }
36

```

check command usage

source file exists?

target file exists?

create a Scanner
create a PrintWriter

has next?
read a line


```

37     input.close();
38     output.close();
39 }
40 }

```

close file

In a normal situation, the program is terminated after a file is copied. The program is terminated abnormally if the command-line arguments are not used properly (lines 7–11), if the source file does not exist (lines 14–18), or if the target file already exists (lines 22–25). The exit status code 1, 2, and 3 are used to indicate these abnormal terminations (lines 10, 17, 24).

14.29 How do you create a **PrintWriter** to write data to a file? What is the reason to declare **throws Exception** in the main method in Listing 14.13, WriteData.java? What would happen if the **close()** method were not invoked in Listing 14.13?



MyProgrammingLab™

14.30 Show the contents of the file **temp.txt** after the following program is executed.

```

public class Test {
    public static void main(String[] args) throws Exception {
        java.io.PrintWriter output = new
            java.io.PrintWriter("temp.txt");
        output.printf("amount is %f %e\r\n", 32.32, 32.32);
        output.printf("amount is %5.4f %5.4e\r\n", 32.32, 32.32);
        output.printf("%6b\r\n", (1 > 2));
        output.printf("%6s\r\n", "Java");
        output.close();
    }
}

```

14.31 How do you create a **Scanner** to read data from a file? What is the reason to define **throws Exception** in the main method in Listing 14.14, ReadData.java? What would happen if the **close()** method were not invoked in Listing 14.14?

14.32 What will happen if you attempt to create a **Scanner** for a nonexistent file? What will happen if you attempt to create a **PrintWriter** for an existing file?

14.33 Is the line separator the same on all platforms? What is the line separator on Windows?

14.34 Suppose you enter **45 57.8 789**, then press the *Enter* key. Show the contents of the variables after the following code is executed.

```

Scanner input = new Scanner(System.in);
int intValue = input.nextInt();
double doubleValue = input.nextDouble();
String line = input.nextLine();

```

14.35 Suppose you enter **45**, press the *Enter* key, **57.8**, press the *Enter* key, **789**, and press the *Enter* key. Show the contents of the variables after the following code is executed.

```

Scanner input = new Scanner(System.in);
int intValue = input.nextInt();
double doubleValue = input.nextDouble();
String line = input.nextLine();

```

14.12 File Dialogs

JFileChooser is a GUI component for displaying a file dialog.

Java provides the **javax.swing.JFileChooser** class for displaying a file dialog, as shown in Figure 14.10. From this dialog box, the user can choose a file.



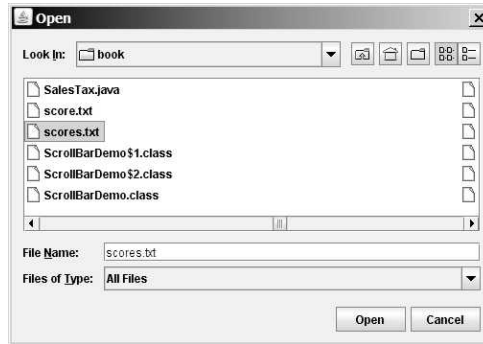


FIGURE 14.10 `JFileChooser` can be used to display a file dialog for opening a file.

Listing 14.16 gives a program that prompts the user to choose a file and displays its contents on the console.

LISTING 14.16 `ReadFileUsingJFileChooser.java`

create a `JFileChooser`
display file chooser
check status

`getSelectedFile`

```

1  import java.util.Scanner;
2  import javax.swing.JFileChooser;
3
4  public class ReadFileUsingJFileChooser {
5      public static void main(String[] args) throws Exception {
6          JFileChooser fileChooser = new JFileChooser();
7          if (fileChooser.showOpenDialog(null)
8              == JFileChooser.APPROVE_OPTION) {
9              // Get the selected file
10             java.io.File file = fileChooser.getSelectedFile();
11
12             // Create a Scanner for the file
13             Scanner input = new Scanner(file);
14
15             // Read text from the file
16             while (input.hasNext()) {
17                 System.out.println(input.nextLine());
18             }
19
20             // Close the file
21             input.close();
22         }
23         else {
24             System.out.println("No file selected");
25         }
26     }
27 }

```

`showOpenDialog`

`APPROVE_OPTION`

`getSelectedFile`

The program creates a `JFileChooser` in line 6. The `showOpenDialog(null)` method displays a dialog box, as shown in Figure 14.10. The method returns an `int` value, either `APPROVE_OPTION` or `CANCEL_OPTION`, which indicates whether the *Open* button or the *Cancel* button was clicked.

The `getSelectedFile()` method (line 10) returns the selected file from the file dialog box. Line 13 creates a scanner for the file. The program continuously reads the lines from the file and displays them to the console (lines 16–18).



Check
Point

14.36 How do you create a File Open dialog box? What is returned from invoking `getSelectedFile()` on a `JFileChooser` object?

14.13 Reading Data from the Web

Just like you can read data from a file on your computer, you can read data from a file on the Web.



In addition to reading data from a local file on a computer or file server, you can also access data from a file that is on the Web if you know the file's URL (Uniform Resource Locator—the unique address for a file on the Web). For example, www.google.com/index.html is the URL for the file **index.html** located on the Google Web server. When you enter the URL in a Web browser, the Web server sends the data to your browser, which renders the data graphically. Figure 14.11 illustrates how this process works.

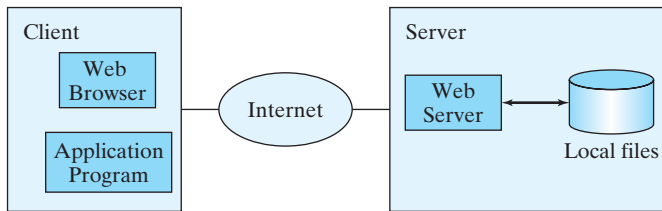


FIGURE 14.11 The client retrieves files from a Web server.

For an application program to read data from a URL, you first need to create a **URL** object using the **java.net.URL** class with this constructor:

```
public URL(String spec) throws MalformedURLException
```

For example, the following statement creates a URL object for <http://www.google.com/index.html>.

```
1 try {
2     URL url = new URL("http://www.google.com/index.html");
3 }
4 catch (MalformedURLException ex) {
5     ex.printStackTrace();
6 }
```

A **MalformedURLException** is thrown if the URL string has a syntax error. For example, the URL string “<http://www.google.com/index.html>” would cause a **MalformedURLException** runtime error because two slashes (//) are required after the colon (:). Note that the **http://** prefix is required for the **URL** class to recognize a valid URL. It would be wrong if you replace line 2 with the following code:

```
URL url = new URL("www.google.com/index.html");
```

After a **URL** object is created, you can use the **openStream()** method defined in the **URL** class to open an input stream and use this stream to create a **Scanner** object as follows:

```
Scanner input = new Scanner(url.openStream());
```

Now you can read the data from the input stream just like from a local file. The example in Listing 14.17 prompts the user to enter a URL and displays the size of the file.

LISTING 14.17 ReadFileFromURL.java

```
1 import java.util.Scanner;
2
```

```

3 public class ReadFileFromURL {
4     public static void main(String[] args) {
5         System.out.print("Enter a URL: ");
6         String urlString = new Scanner(System.in).next();
7
8         try {
9             java.net.URL url = new java.net.URL(urlString);
10            int count = 0;
11            Scanner input = new Scanner(url.openStream());
12            while (input.hasNext()) {
13                String line = input.nextLine();
14                count += line.length();
15            }
16
17            System.out.println("The file size is " + count + " bytes");
18        }
19        catch (java.net.MalformedURLException ex) {
20            System.out.println("Invalid URL");
21        }
22        catch (java.io.IOException ex) {
23            System.out.println("I/O Errors: no such file");
24        }
25    }
26 }

```

enter a URL

create a URL object

create a Scanner object
more to read?
read a line

MalformedURLException

IOException



```

Enter a URL: http://cs.armstrong.edu/liang/data/Lincoln.txt ↵ Enter
The file size is 1469 bytes

```



```

Enter a URL: http://www.yahoo.com ↵ Enter
The file size is 190006 bytes

```

MalformedURLException

The program prompts the user to enter a URL string (line 6) and creates a **URL** object (line 9). The constructor will throw a **java.net.MalformedURLException** (line 19) if the URL isn't formed correctly.

The program creates a **Scanner** object from the input stream for the URL (line 11). If the URL is formed correctly but does not exist, an **IOException** will be thrown (line 22). For example, <http://google.com/index1.html> uses the appropriate form, but the URL itself does not exist. An **IOException** would be thrown if this URL was used for this program.



14.37 How do you create a **Scanner** object for reading text from a URL?

MyProgrammingLab™

KEY TERMS

absolute file name 541
 chained exception 537
 checked exception 525
 declare exception 526
 directory path 541

exception 518
 exception propagation 527
 relative file name 541
 throw exception 526
 unchecked exception 525

CHAPTER SUMMARY

1. Exception handling enables a method to throw an exception to its caller.
2. A Java *exception* is an instance of a class derived from `java.lang.Throwable`. Java provides a number of predefined exception classes, such as `Error`, `Exception`, `RuntimeException`, `ClassNotFoundException`, `NullPointerException`, and `ArithmeticException`. You can also define your own exception class by extending `Exception`.
3. Exceptions occur during the execution of a method. `RuntimeException` and `Error` are *unchecked exceptions*; all other exceptions are *checked*.
4. When *declaring a method*, you have to declare a checked exception if the method might throw it, thus telling the compiler what can go wrong.
5. The keyword for declaring an exception is `throws`, and the keyword for throwing an exception is `throw`.
6. To invoke the method that declares checked exceptions, enclose it in a `try` statement. When an exception occurs during the execution of the method, the `catch` block catches and handles the exception.
7. If an exception is not caught in the current method, it is passed to its caller. The process is repeated until the exception is caught or passed to the `main` method.
8. Various exception classes can be derived from a common superclass. If a `catch` block catches the exception objects of a superclass, it can also catch all the exception objects of the subclasses of that superclass.
9. The order in which exceptions are specified in a `catch` block is important. A compile error will result if you specify an exception object of a class after an exception object of the superclass of that class.
10. When an exception occurs in a method, the method exits immediately if it does not catch the exception. If the method is required to perform some task before exiting, you can catch the exception in the method and then rethrow it to its caller.
11. The code in the `finally` block is executed under all circumstances, regardless of whether an exception occurs in the `try` block or whether an exception is caught if it occurs.
12. Exception handling separates error-handling code from normal programming tasks, thus making programs easier to read and to modify.
13. Exception handling should not be used to replace simple tests. You should perform simple test using `if` statements whenever possible, and reserve exception handling for dealing with situations that cannot be handled with `if` statements.
14. The `File` class is used to obtain file properties and manipulate files. It does not contain the methods for creating a file or for reading/writing data from/to a file.

15. You can use **Scanner** to read string and primitive data values from a text file and use **PrintWriter** to create a file and write data to a text file.
16. The **JFileChooser** class can be used to display file dialogs for choosing files.
17. You can read from a file on the Web using the **URL** class.

TEST QUESTIONS

Do the test questions for this chapter online at www.cs.armstrong.edu/liang/intro9e/test.html.

MyProgrammingLab™

PROGRAMMING EXERCISES

Sections 14.2–14.9

- *14.1 (**NumberFormatException**) Listing 9.5, `Calculator.java`, is a simple command-line calculator. Note that the program terminates if any operand is nonnumeric. Write a program with an exception handler that deals with nonnumeric operands; then write another program without using an exception handler to achieve the same objective. Your program should display a message that informs the user of the wrong operand type before exiting (see Figure 14.12).



```

Administrator: Command Prompt
c:\exercise>java Exercise14_01 "4 + 5"
4 + 5 = 9
c:\exercise>java Exercise14_01 "4 - 5"
4 - 5 = -1
c:\exercise>java Exercise14_01 "4x - 5"
Wrong Input: 4x
c:\exercise>_
  
```

FIGURE 14.12 The program performs arithmetic operations and detects input errors.

- *14.2 (**InputMismatchException**) Write a program that prompts the user to read two integers and displays their sum. Your program should prompt the user to read the number again if the input is incorrect.
- *14.3 (**ArrayIndexOutOfBoundsException**) Write a program that meets the following requirements:
- Creates an array with **100** randomly chosen integers.
 - Prompts the user to enter the index of the array, then displays the corresponding element value. If the specified index is out of bounds, display the message **Out of Bounds**.
- *14.4 (**IllegalArgumentException**) Modify the **Loan** class in Listing 10.2 to throw **IllegalArgumentException** if the loan amount, interest rate, or number of years is less than or equal to zero.
- *14.5 (**IllegalTriangleException**) Programming Exercise 11.1 defined the **Triangle** class with three sides. In a triangle, the sum of any two sides is greater than the other side. The **Triangle** class must adhere to this rule. Create the **IllegalTriangleException** class, and modify the constructor of the

Triangle class to throw an **IllegalTriangleException** object if a triangle is created with sides that violate the rule, as follows:

```
/** Construct a triangle with the specified sides */
public Triangle(double side1, double side2, double side3)
    throws IllegalTriangleException {
    // Implement it
}
```

- * 14.6 (*NumberFormatException*) Listing 9.2 implements the **hexToDecimal** (**String hexString**) method, which converts a hex string into a decimal number. Implement the **hexToDecimal** method to throw a **NumberFormatException** if the string is not a hex string.
- * 14.7 (*NumberFormatException*) Programming Exercise 9.8 specifies the **binaryToDecimal** (**String binaryString**) method, which converts a binary string into a decimal number. Implement the **binaryToDecimal** method to throw a **NumberFormatException** if the string is not a binary string.
- * 14.8 (*HexFormatException*) Exercise 14.6 implements the **hexToDecimal** method to throw a **NumberFormatException** if the string is not a hex string. Define a custom exception called **HexFormatException**. Implement the **hexToDecimal** method to throw a **HexFormatException** if the string is not a hex string.
- * 14.9 (*BinaryFormatException*) Exercise 14.7 implements the **binaryToDecimal** method to throw a **BinaryFormatException** if the string is not a binary string. Define a custom exception called **BinaryFormatException**. Implement the **binaryToDecimal** method to throw a **BinaryFormatException** if the string is not a binary string.
- * 14.10 (*OutOfMemoryError*) Write a program that causes the JVM to throw an **OutOfMemoryError** and catches and handles this error.



VideoNote

HexFormatException

Sections 14.10–14.12

- ** 14.11 (*Remove text*) Write a program that removes all the occurrences of a specified string from a text file. For example, invoking

```
java Exercise14_11 John filename
```

removes the string **John** from the specified file. Your program should get the arguments from the command line.

- ** 14.12 (*Reformat Java source code*) Write a program that converts the Java source code from the next-line brace style to the end-of-line brace style. For example, the following Java source in (a) uses the next-line brace style. Your program converts it to the end-of-line brace style in (b).

```
public class Test
{
    public static void main(String[] args)
    {
        // Some statements
    }
}
```

(a) Next-line brace style

```
public class Test {
    public static void main(String[] args) {
        // Some statements
    }
}
```

(b) End-of-line brace style

Your program can be invoked from the command line with the Java source-code file as the argument. It converts the Java source code to a new format. For example, the following command converts the Java source-code file **Test.java** to the end-of-line brace style.

```
java Exercise14_12 Test.java
```

- *14.13** (*Count characters, words, and lines in a file*) Write a program that will count the number of characters, words, and lines in a file. Words are separated by whitespace characters. The file name should be passed as a command-line argument, as shown in Figure 14.13.



FIGURE 14.13 The program displays the number of characters, words, and lines in the given file.

- *14.14** (*Process scores in a text file*) Suppose that a text file contains an unspecified number of scores separated by blanks. Write a program that prompts the user to enter the file, reads the scores from the file, and displays their total and average. Scores are separated by blanks.
- *14.15** (*Write/read data*) Write a program to create a file named **Exercise14_15.txt** if it does not exist. Write **100** integers created randomly into the file using text I/O. Integers are separated by spaces in the file. Read the data back from the file and display the sorted data.
- **14.16** (*Replace text*) Listing 14.15, **ReplaceText.java**, gives a program that replaces text in a source file and saves the change into a new file. Revise the program to save the change into the original file. For example, invoking

```
java Exercise14_16 file oldString newString
```

replaces **oldString** in the source file with **newString**.

- ***14.17** (*Game: hangman*) Rewrite Exercise 9.25. The program reads the words stored in a text file named **hangman.txt**. Words are delimited by spaces.
- **14.18** (*Add package statement*) Suppose you have Java source files under the directories **chapter1**, **chapter2**, . . . , **chapter34**. Write a program to insert the statement **package chapteri;** as the first line for each Java source file under the directory **chapteri**. Suppose **chapter1**, **chapter2**, . . . , **chapter34** are under the root directory **srcRootDirectory**. The root directory and **chapteri** directory may contain other folders and files. Use the following command to run the program:

```
java Exercise14_18 srcRootDirectory
```

- *14.19** (*Count words*) Write a program that counts the number of words in President Abraham Lincoln's Gettysburg address from <http://cs.armstrong.edu/liang/data/Lincoln.txt>.

****14.20** (*Remove package statement*) Suppose you have Java source files under the directories `chapter1`, `chapter2`, . . . , `chapter34`. Write a program to remove the statement `package chapteri`; in the first line for each Java source file under the directory `chapteri`. Suppose `chapter1`, `chapter2`, . . . , `chapter34` are under the root directory `srcRootDirectory`. The root directory and `chapteri` directory may contain other folders and files. Use the following command to run the program:

```
java Exercise14_20 srcRootDirectory
```

****14.21** (*Display a graph*) A graph consists of vertices and edges that connect vertices. Write a program that reads a graph from a file and displays it on a panel. The first line in the file contains a number that indicates the number of vertices (`n`). The vertices are labeled as `0, 1, . . . , n-1`. Each subsequent line, with the format `u x y v1 v2 . . .`, describes that the vertex `u` is located at position `(x, y)` with edges `(u, v1)`, `(u, v2)`, and so on. Figure 14.14a gives an example of the file for a graph. Your program prompts the user to enter the name of the file, reads data from the file, and displays the graph on a panel, as shown in Figure 14.14b. Write another program that reads data from a Web URL such as <http://cs.armstrong.edu/liang/data/graph.txt>. This program should prompt the user to enter the URL for the file.

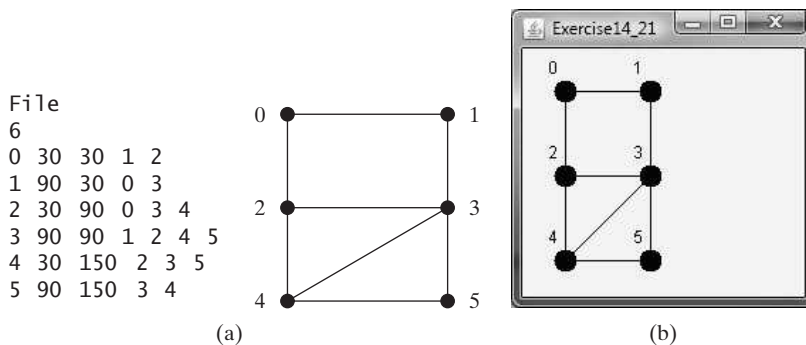


FIGURE 14.14 Exercise 14.21 reads the information about the graph and displays it visually.

****14.22** (*Replace text*) Revise Exercise 14.16 to replace a string in a file with a new string for all files in the specified directory using the command:

```
java Exercise14_22 dir oldString newString
```

****14.23** (*Process scores in a text file on the Web*) Suppose that the text file on the Web <http://cs.armstrong.edu/liang/data/Scores.txt> contains an unspecified number of scores. Write a program that reads the scores from the file and displays their total and average. Scores are separated by blanks.

***14.24** (*Create large dataset*) Create a data file with 1,000 lines. Each line in the file consists of a faculty member's first name, last name, rank, and salary. The faculty member's first name and last name for the i th line are `FirstName i` and `LastName i` . The rank is randomly generated as assistant, associate, and full. The salary is randomly generated as a number with two digits after the decimal point. The salary for an assistant professor should be in the range from 50,000 to

80,000, for associate professor from 60,000 to 110,000, and for full professor from 75,000 to 130,000. Save the file in **Salary.txt**. Here are some sample data:

FirstName1 LastName1 assistant 60055.95

FirstName2 LastName2 associate 81112.45

...

FirstName1000 LastName1000 full 92255.21

*** 14.25** (*Process large dataset*) A university posts its employees' salaries at <http://cs.armstrong.edu/liang/data/Salary.txt>. Each line in the file consists of a faculty member's first name, last name, rank, and salary (see Exercise 14.24). Write a program to display the total salary for assistant professors, associate professors, full professors, and all faculty, respectively, and display the average salary for assistant professors, associate professors, full professors, and all faculty, respectively.

**** 14.26** (*Create a directory*) Write a program that prompts the user to enter a directory name and creates a directory using the **File**'s **mkdirs** method. The program displays the message "Directory created successfully" if a directory is created or "Directory already exists" if the directory already exists.

**** 14.27** (*Replace words*) Suppose you have a lot of files in a directory that contain words **Exercise i _ j** , where i and j are digits. Write a program that pads a 0 before i if i is a single digit and 0 before j if j is a single digit. For example, the word **Exercise2_1** in a file will be replaced by **Exercise02_01**. In Java, when you pass the symbol ***** from the command line, it refers to all files in the directory (see Supplement III.AC). Use the following command to run your program.

```
java Exercise14_27 *
```

**** 14.28** (*Rename files*) Suppose you have a lot of files in a directory named **Exercise i _ j** , where i and j are digits. Write a program that pads a 0 before i if i is a single digit. For example, a file named **Exercise2_1** in a directory will be renamed to **Exercise02_1**. In Java, when you pass the symbol ***** from the command line, it refers to all files in the directory (see Supplement III.AC). Use the following command to run your program.

```
java Exercise14_28 *
```

**** 14.29** (*Rename files*) Suppose you have a lot of files in a directory named **Exercise i _ j** , where i and j are digits. Write a program that pads a 0 before j if j is a single digit. For example, a file named **Exercise2_1** in a directory will be renamed to **Exercise2_01**. In Java, when you pass the symbol ***** from the command line, it refers to all files in the directory (see Supplement III.AC). Use the following command to run your program.

```
java Exercise14_29 *
```

ABSTRACT CLASSES AND INTERFACES

Objectives

- To design and use abstract classes (§15.2).
- To generalize numeric wrapper classes, `BigInteger`, and `BigDecimal` using the abstract `Number` class (§15.3).
- To process a calendar using the `Calendar` and `GregorianCalendar` classes (§15.4).
- To specify common behavior for objects using interfaces (§15.5).
- To define interfaces and define classes that implement interfaces (§15.5).
- To define a natural order using the `Comparable` interface (§15.6).
- To make objects cloneable using the `Cloneable` interface (§15.7).
- To explore the similarities and differences among concrete classes, abstract classes, and interfaces (§15.8).
- To design the `Rational` class for processing rational numbers (§15.9).



15.1 Introduction



A superclass defines common behavior for related subclasses. An interface can be used to define common behavior for classes (including unrelated classes).

problem
interface

You have learned how to write simple programs to create and display GUI components. Can you write the code to respond to user actions, such as clicking a button to perform an action?

In order to write such code, you have to know about interfaces. An *interface* is for defining common behavior for classes (including unrelated classes). Before discussing interfaces, we introduce a closely related subject: abstract classes.

15.2 Abstract Classes



An abstract class cannot be used to create objects. An abstract class can contain abstract methods, which are implemented in concrete subclasses.



VideoNote

Abstract GeometricObject
class

abstract class

In the inheritance hierarchy, classes become more specific and concrete *with each new subclass*. If you move from a subclass back up to a superclass, the classes become more general and less specific. Class design should ensure that a superclass contains common features of its subclasses. Sometimes a superclass is so abstract that it cannot have any specific instances. Such a class is referred to as an *abstract class*.

In Chapter 11, `GeometricObject` was defined as the superclass for `Circle` and `Rectangle`. `GeometricObject` models common features of geometric objects. Both `Circle` and `Rectangle` contain the `getArea()` and `getPerimeter()` methods for computing the area and perimeter of a circle and a rectangle. Since you can compute areas and perimeters for all geometric objects, it is better to define the `getArea()` and `getPerimeter()` methods in the `GeometricObject` class. However, these methods cannot be implemented in the `GeometricObject` class, because their implementation depends on the specific type of geometric object. Such methods are referred to as *abstract methods* and are denoted using the *abstract* modifier in the method header. After you define the methods in `GeometricObject`, it becomes an abstract class. Abstract classes are denoted using the *abstract* modifier in the class header. In UML graphic notation, the names of abstract classes and their abstract methods are italicized, as shown in Figure 15.1. Listing 15.1 gives the source code for the new `GeometricObject` class.

abstract method

abstract modifier

LISTING 15.1 GeometricObject.java

abstract class

```

1  public abstract class GeometricObject {
2      private String color = "white";
3      private boolean filled;
4      private java.util.Date dateCreated;
5
6      /** Construct a default geometric object */
7      protected GeometricObject() {
8          dateCreated = new java.util.Date();
9      }
10
11     /** Construct a geometric object with color and filled value */
12     protected GeometricObject(String color, boolean filled) {
13         dateCreated = new java.util.Date();
14         this.color = color;
15         this.filled = filled;
16     }
17
18     /** Return color */
19     public String getColor() {
20         return color;

```

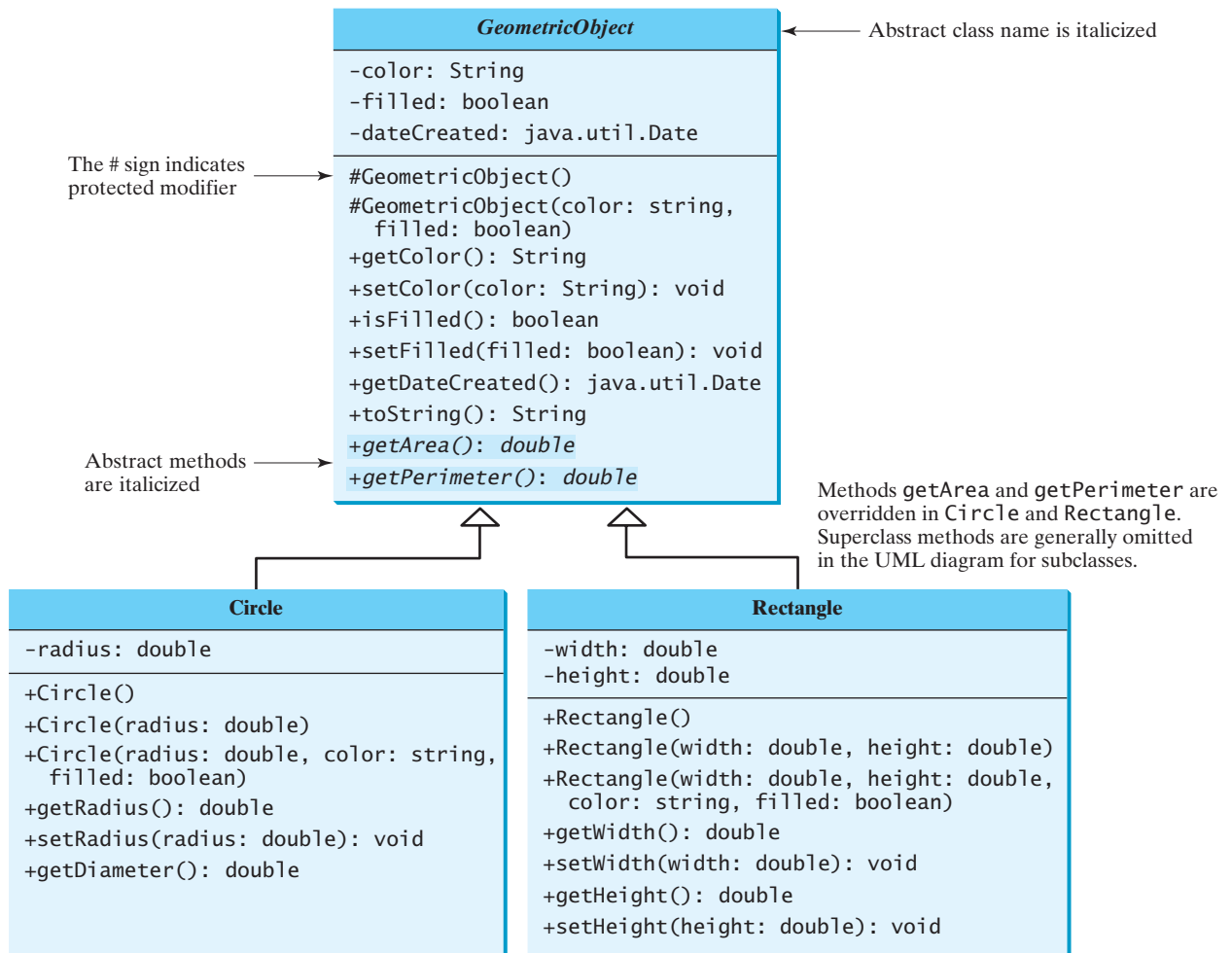


FIGURE 15.1 The new **GeometricObject** class contains abstract methods.

```

21 }
22
23 /** Set a new color */
24 public void setColor(String color) {
25     this.color = color;
26 }
27
28 /** Return filled. Since filled is boolean,
29  * the get method is named isFilled */
30 public boolean isFilled() {
31     return filled;
32 }
33
34 /** Set a new filled */
35 public void setFilled(boolean filled) {
36     this.filled = filled;
37 }
38
39 /** Get dateCreated */
40 public java.util.Date getDateCreated() {

```

```

41     return dateCreated;
42 }
43
44 @Override
45 public String toString() {
46     return "created on " + dateCreated + "\ncolor: " + color +
47         " and filled: " + filled;
48 }
49
50 /** Abstract method getArea */
51 public abstract double getArea();
52
53 /** Abstract method getPerimeter */
54 public abstract double getPerimeter();
55 }

```

abstract method

abstract method

Abstract classes are like regular classes, but you cannot create instances of abstract classes using the `new` operator. An abstract method is defined without implementation. Its implementation is provided by the subclasses. A class that contains abstract methods must be defined as abstract.

why protected constructor?

The constructor in the abstract class is defined as protected, because it is used only by subclasses. When you create an instance of a concrete subclass, its superclass's constructor is invoked to initialize data fields defined in the superclass.

implementing Circle
implementing Rectangle

The `GeometricObject` abstract class defines the common features (data and methods) for geometric objects and provides appropriate constructors. Because you don't know how to compute areas and perimeters of geometric objects, `getArea` and `getPerimeter` are defined as abstract methods. These methods are implemented in the subclasses. The implementation of `Circle` and `Rectangle` is the same as in Listings 15.2 and 15.3, except that they extend the `GeometricObject` class defined in this chapter.

LISTING 15.2 Circle.java

```

1 public class Circle extends GeometricObject {
2     // Same as lines 3-48 in Listing 11.2, so omitted
3 }

```

extends abstract
GeometricObject

LISTING 15.3 Rectangle.java

```

1 public class Rectangle extends GeometricObject {
2     // Same as lines 3-51 in Listing 11.3, so omitted
3 }

```

extends abstract
GeometricObject

15.2.1 Why Abstract Methods?

You may be wondering what advantage is gained by defining the methods `getArea` and `getPerimeter` as abstract in the `GeometricObject` class. The example in Listing 15.4 shows the benefits of defining them in the `GeometricObject` class. The program creates two geometric objects, a circle and a rectangle, invokes the `equalArea` method to check whether they have equal areas, and invokes the `displayGeometricObject` method to display them.

LISTING 15.4 TestGeometricObject.java

```

1 public class TestGeometricObject {
2     /** Main method */
3     public static void main(String[] args) {
4         // Create two geometric objects
5         GeometricObject geoObject1 = new Circle(5);
6         GeometricObject geoObject2 = new Rectangle(5, 3);

```

create a circle
create a rectangle

```

7
8     System.out.println("The two objects have the same area? " +
9         equalArea(geoObject1, geoObject2));
10
11     // Display circle
12     displayGeometricObject(geoObject1);
13
14     // Display rectangle
15     displayGeometricObject(geoObject2);
16 }
17
18 /** A method for comparing the areas of two geometric objects */
19 public static boolean equalArea(GeometricObject object1,           equalArea
20     GeometricObject object2) {
21     return object1.getArea() == object2.getArea();
22 }
23
24 /** A method for displaying a geometric object */
25 public static void displayGeometricObject(GeometricObject object) { displayGeometricObject
26     System.out.println();
27     System.out.println("The area is " + object.getArea());
28     System.out.println("The perimeter is " + object.getPerimeter());
29 }
30 }

```

```
The two objects have the same area? false
```

```
The area is 78.53981633974483
The perimeter is 31.41592653589793
```

```
The area is 15.0
The perimeter is 16.0
```



The methods `getArea()` and `getPerimeter()` defined in the `GeometricObject` class are overridden in the `Circle` class and the `Rectangle` class. The statements (lines 5–6)

```
GeometricObject geoObject1 = new Circle(5);
GeometricObject geoObject2 = new Rectangle(5, 3);
```

create a new circle and rectangle and assign them to the variables `geoObject1` and `geoObject2`. These two variables are of the `GeometricObject` type.

When invoking `equalArea(geoObject1, geoObject2)` (line 9), the `getArea()` method defined in the `Circle` class is used for `object1.getArea()`, since `geoObject1` is a circle, and the `getArea()` method defined in the `Rectangle` class is used for `object2.getArea()`, since `geoObject2` is a rectangle.

Similarly, when invoking `displayGeometricObject(geoObject1)` (line 12), the methods `getArea()` and `getPerimeter()` defined in the `Circle` class are used, and when invoking `displayGeometricObject(geoObject2)` (line 15), the methods `getArea` and `getPerimeter` defined in the `Rectangle` class are used. The JVM dynamically determines which of these methods to invoke at runtime, depending on the actual object that invokes the method.

Note that you could not define the `equalArea` method for comparing whether two geometric objects have the same area if the `getArea` method were not defined in `GeometricObject`. Now you have seen the benefits of defining the abstract methods in `GeometricObject`.

why abstract methods?

15.2.2 Interesting Points about Abstract Classes

The following points about abstract classes are worth noting:

abstract method in abstract class

- An abstract method cannot be contained in a nonabstract class. If a subclass of an abstract superclass does not implement all the abstract methods, the subclass must be defined as abstract. In other words, in a nonabstract subclass extended from an abstract class, all the abstract methods must be implemented. Also note that abstract methods are nonstatic.

object cannot be created from abstract class

- An abstract class cannot be instantiated using the `new` operator, but you can still define its constructors, which are invoked in the constructors of its subclasses. For instance, the constructors of `GeometricObject` are invoked in the `Circle` class and the `Rectangle` class.

abstract class without abstract method

- A class that contains abstract methods must be abstract. However, it is possible to define an abstract class that doesn't contain any abstract methods. In this case, you cannot create instances of the class using the `new` operator. This class is used as a base class for defining subclasses.

superclass of abstract class may be concrete

- A subclass can be abstract even if its superclass is concrete. For example, the `Object` class is concrete, but its subclasses, such as `GeometricObject`, may be abstract.

concrete method overridden to be abstract

- A subclass can override a method from its superclass to define it as abstract. This is *very unusual*, but it is useful when the implementation of the method in the superclass becomes invalid in the subclass. In this case, the subclass must be defined as abstract.

abstract class as type

- You cannot create an instance from an abstract class using the `new` operator, but an abstract class can be used as a data type. Therefore, the following statement, which creates an array whose elements are of the `GeometricObject` type, is correct.

```
GeometricObject[] objects = new GeometricObject[10];
```

You can then create an instance of `GeometricObject` and assign its reference to the array like this:

```
objects[0] = new Circle();
```



15.1 Which of the following classes defines a legal abstract class?

MyProgrammingLab™

```
class A {
    abstract void unfinished() {
    }
}
```

(a)

```
public class abstract A {
    abstract void unfinished();
}
```

(b)

```
class A {
    abstract void unfinished();
}
```

(c)

```
abstract class A {
    protected void unfinished();
}
```

(d)

```
abstract class A {
    abstract void unfinished();
}
```

(e)

```
abstract class A {
    abstract int unfinished();
}
```

(f)

15.2 The `getArea` and `getPerimeter` methods may be removed from the `GeometricObject` class. What are the benefits of defining `getArea` and `getPerimeter` as abstract methods in the `GeometricObject` class?

15.3 True or false?

- An abstract class can be used just like a nonabstract class except that you cannot use the `new` operator to create an instance from the abstract class.
- An abstract class can be extended.
- A subclass of a nonabstract superclass cannot be abstract.
- A subclass cannot override a concrete method in a superclass to define it as abstract.
- An abstract method must be nonstatic.

15.3 Case Study: the Abstract **Number** Class

Number is an abstract superclass for numeric wrapper classes, **BigInteger**, and **BigDecimal**.



Section 10.12 introduced numeric wrapper classes and Section 10.14 introduced the **BigInteger** and **BigDecimal** classes. These classes have common methods `byteValue()`, `shortValue()`, `intValue()`, `longValue()`, `floatValue()`, and `doubleValue()` for returning a **byte**, **short**, **int**, **long**, **float**, and **double** value from an object of these classes. These common methods are actually defined in the **Number** class, which is a superclass for the numeric wrapper classes, **BigInteger**, and **BigDecimal**, as shown in Figure 15.2.

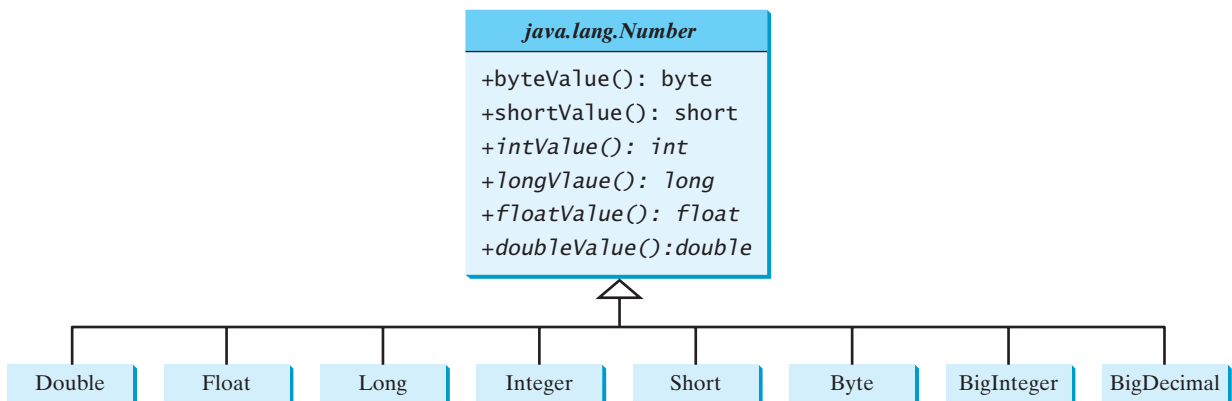


FIGURE 15.2 The **Number** class is an abstract superclass for **Double**, **Float**, **Long**, **Integer**, **Short**, **Byte**, **BigInteger** and **BigDecimal**.

Since the `intValue()`, `longValue()`, `floatValue()`, and `doubleValue()` methods cannot be implemented in the **Number** class, they are defined as abstract methods in the **Number** class. The **Number** class is therefore an abstract class. The `byteValue()` and `shortValue()` method are implemented from the `intValue()` method as follows:

```

public byte byteValue() {
    return (byte)intValue();
}
  
```

```

    public short shortValue() {
        return (short)intValue();
    }

```

With `Number` defined as the superclass for the numeric classes, we can define methods to perform common operations for numbers. Listing 15.5 gives a program that finds the largest number in a list of `Number` objects.

LISTING 15.5 LargestNumbers.java

```

1  import java.util.ArrayList;
2  import java.math.*;
3
4  public class LargestNumbers {
5      public static void main(String[] args) {
6          ArrayList<Number> list = new ArrayList<Number>();
7          list.add(45); // Add an integer
8          list.add(3445.53); // Add a double
9          // Add a BigInteger
10         list.add(new BigInteger("3432323234344343101"));
11         // Add a BigDecimal
12         list.add(new BigDecimal("2.0909090989091343433344343"));
13
14         System.out.println("The largest number is " +
15             getLargestNumber(list));
16     }
17
18     public static Number getLargestNumber(ArrayList<Number> list) {
19         if (list == null || list.size() == 0)
20             return null;
21
22         Number number = list.get(0);
23         for (int i = 1; i < list.size(); i++)
24             if (number.doubleValue() < list.get(i).doubleValue())
25                 number = list.get(i);
26
27         return number;
28     }
29 }

```

create an array list
add number to list

invoke getLargestNumber

doubleValue

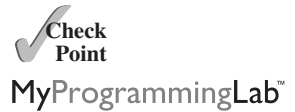


The largest number is 3432323234344343101

The program creates an `ArrayList` of `Number` objects (line 6). It adds an `Integer` object, a `Double` object, a `BigInteger` object, and a `BigDecimal` object to the list (lines 7–12). Note that `45` is automatically converted into an `Integer` object and added to the list in line 7 and that `3445.53` is automatically converted into a `Double` object and added to the list in line 8 using autoboxing.

Invoking the `getLargestNumber` method returns the largest number in the list (line 15). The `getLargestNumber` method returns `null` if the list is `null` or the list size is `0` (lines 19–20). To find the largest number in the list, the numbers are compared by invoking their `doubleValue()` method (line 24). The `doubleValue()` method is defined in the `Number` class and implemented in the concrete subclass of `Number`. If a number is an `Integer` object, the `Integer`'s `doubleValue()` is invoked. If a number is a `BigDecimal` object, the `BigDecimal`'s `doubleValue()` is invoked.

If the `doubleValue()` method is not defined in the `Number` class. You will not be able to find the largest number among different types of numbers using the `Number` class.



15.4 Why do the following two lines of code compile but cause a runtime error?

```
Number numberRef = new Integer(0);
Double doubleRef = (Double)numberRef;
```

15.5 Why do the following two lines of code compile but cause a runtime error?

```
Number[] numberArray = new Integer[2];
numberArray[0] = new Double(1.5);
```

15.6 Show the output of the following code.

```
public class Test {
    public static void main(String[] args) {
        Number x = 3;
        System.out.println(x.intValue());
        System.out.println(x.doubleValue());
    }
}
```

15.7 What is wrong in the following code? (Note that the `compareTo` method for the `Integer` and `Double` classes was introduced in Section 10.12.)

```
public class Test {
    public static void main(String[] args) {
        Number x = new Integer(3);
        System.out.println(x.intValue());
        System.out.println(x.compareTo(new Integer(4)));
    }
}
```

15.8 What is wrong in the following code?

```
public class Test {
    public static void main(String[] args) {
        Number x = new Integer(3);
        System.out.println(x.intValue());
        System.out.println((Integer)x.compareTo(new Integer(4)));
    }
}
```

15.4 Case Study: Calendar and GregorianCalendar

`GregorianCalendar` is a concrete subclass of the abstract class `Calendar`.

An instance of `java.util.Date` represents a specific instant in time with millisecond precision. `java.util.Calendar` is an abstract base class for extracting detailed calendar information, such as the year, month, date, hour, minute, and second. Subclasses of `Calendar` can implement specific calendar systems, such as the Gregorian calendar, the lunar calendar, and the Jewish calendar. Currently, `java.util.GregorianCalendar` for the Gregorian calendar is supported in Java, as shown in Figure 15.3. The `add` method is abstract in the `Calendar` class, because its implementation is dependent on a concrete calendar system.

You can use `new GregorianCalendar()` to construct a default `GregorianCalendar` with the current time and `new GregorianCalendar(year, month, date)` to construct a `GregorianCalendar` with the specified `year`, `month`, and `date`. The `month` parameter is 0 based—that is, 0 is for January.



VideoNote

Calendar and
GregorianCalendar
classes

abstract add method

constructing calendar

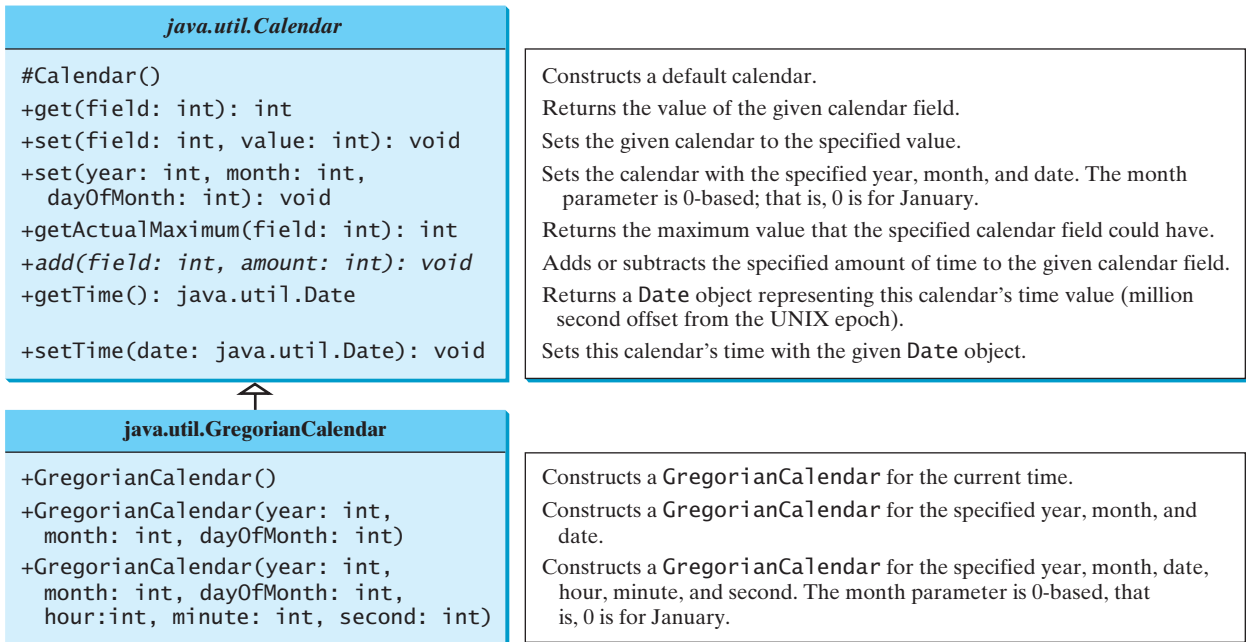


FIGURE 15.3 The abstract `Calendar` class defines common features of various calendars.

`get(field)`

The `get(int field)` method defined in the `Calendar` class is useful for extracting the date and time information from a `Calendar` object. The fields are defined as constants, as shown in Table 15.1.

TABLE 15.1 Field Constants in the `Calendar` Class

<i>Constant</i>	<i>Description</i>
<code>YEAR</code>	The year of the calendar.
<code>MONTH</code>	The month of the calendar, with 0 for January.
<code>DATE</code>	The day of the calendar.
<code>HOUR</code>	The hour of the calendar (12-hour notation).
<code>HOUR_OF_DAY</code>	The hour of the calendar (24-hour notation).
<code>MINUTE</code>	The minute of the calendar.
<code>SECOND</code>	The second of the calendar.
<code>DAY_OF_WEEK</code>	The day number within the week, with 1 for Sunday.
<code>DAY_OF_MONTH</code>	Same as <code>DATE</code> .
<code>DAY_OF_YEAR</code>	The day number in the year, with 1 for the first day of the year.
<code>WEEK_OF_MONTH</code>	The week number within the month, with 1 for the first week.
<code>WEEK_OF_YEAR</code>	The week number within the year, with 1 for the first week.
<code>AM_PM</code>	Indicator for AM or PM (0 for AM and 1 for PM).

Listing 15.6 gives an example that displays the date and time information for the current time.

LISTING 15.6 TestCalendar.java

```

1 import java.util.*;
2

```

```

3 public class TestCalendar {
4     public static void main(String[] args) {
5         // Construct a Gregorian calendar for the current date and time
6         Calendar calendar = new GregorianCalendar();
7         System.out.println("Current time is " + new Date());
8         System.out.println("YEAR: " + calendar.get(Calendar.YEAR));
9         System.out.println("MONTH: " + calendar.get(Calendar.MONTH));
10        System.out.println("DATE: " + calendar.get(Calendar.DATE));
11        System.out.println("HOUR: " + calendar.get(Calendar.HOUR));
12        System.out.println("HOUR_OF_DAY: " +
13            calendar.get(Calendar.HOUR_OF_DAY));
14        System.out.println("MINUTE: " + calendar.get(Calendar.MINUTE));
15        System.out.println("SECOND: " + calendar.get(Calendar.SECOND));
16        System.out.println("DAY_OF_WEEK: " +
17            calendar.get(Calendar.DAY_OF_WEEK));
18        System.out.println("DAY_OF_MONTH: " +
19            calendar.get(Calendar.DAY_OF_MONTH));
20        System.out.println("DAY_OF_YEAR: " +
21            calendar.get(Calendar.DAY_OF_YEAR));
22        System.out.println("WEEK_OF_MONTH: " +
23            calendar.get(Calendar.WEEK_OF_MONTH));
24        System.out.println("WEEK_OF_YEAR: " +
25            calendar.get(Calendar.WEEK_OF_YEAR));
26        System.out.println("AM_PM: " + calendar.get(Calendar.AM_PM));
27
28        // Construct a calendar for September 11, 2001
29        Calendar calendar1 = new GregorianCalendar(2001, 8, 11);
30        String[] dayNameOfWeek = {"Sunday", "Monday", "Tuesday", "Wednesday",
31            "Thursday", "Friday", "Saturday"};
32        System.out.println("September 11, 2001 is a " +
33            dayNameOfWeek[calendar1.get(Calendar.DAY_OF_WEEK) - 1]);
34    }
35 }

```

calendar for current time

extract fields in calendar

create a calendar

```

Current time is Sun Nov 27 17:48:15 EST 2011
YEAR: 2011
MONTH: 10
DATE: 27
HOUR: 5
HOUR_OF_DAY: 17
MINUTE: 48
SECOND: 15
DAY_OF_WEEK: 1
DAY_OF_MONTH: 27
DAY_OF_YEAR: 331
WEEK_OF_MONTH: 5
WEEK_OF_YEAR: 49
AM_PM: 1
September 11, 2001 is a Tuesday

```



The `set(int field, value)` method defined in the `Calendar` class can be used to set a field. For example, you can use `calendar.set(Calendar.DAY_OF_MONTH, 1)` to set the `calendar` to the first day of the month.

set(field, value)

The `add(field, value)` method adds the specified amount to a given field. For example, `add(Calendar.DAY_OF_MONTH, 5)` adds five days to the current time of the calendar. `add(Calendar.DAY_OF_MONTH, -5)` subtracts five days from the current time of the calendar.

add(field, amount)

```
getActualMaximum(field)
```

```
setTime(date)
getTime()
```

To obtain the number of days in a month, use `calendar.getActualMaximum(Calendar.DAY_OF_MONTH)`. For example, if the `calendar` were for March, this method would return `31`.

You can set a time represented in a `Date` object for the `calendar` by invoking `calendar.setTime(date)` and retrieve the time by invoking `calendar.getTime()`.



15.9 Can you create a `Calendar` object using the `Calendar` class?

15.10 Which method in the `Calendar` class is abstract?

15.11 How do you create a `Calendar` object for the current time?

15.12 For a `Calendar` object `c`, how do you get its year, month, date, hour, minute, and second?

MyProgrammingLab™



15.5 Interfaces

An interface is a class-like construct that contains only constants and abstract methods.

In many ways an interface is similar to an abstract class, but its intent is to specify common behavior for objects of related classes or unrelated classes. For example, using appropriate interfaces, you can specify that the objects are comparable, edible, and/or cloneable.

To distinguish an interface from a class, Java uses the following syntax to define an interface:

```
modifier interface InterfaceName {
    /** Constant declarations */
    /** Abstract method signatures */
}
```

Here is an example of an interface:

```
public interface Edible {
    /** Describe how to eat */
    public abstract String howToEat();
}
```

An interface is treated like a special class in Java. Each interface is compiled into a separate bytecode file, just like a regular class. You can use an interface more or less the same way you use an abstract class. For example, you can use an interface as a data type for a reference variable, as the result of casting, and so on. As with an abstract class, you cannot create an instance from an interface using the `new` operator.

You can use the `Edible` interface to specify whether an object is edible. This is accomplished by letting the class for the object implement this interface using the `implements` keyword. For example, the classes `Chicken` and `Fruit` in Listing 15.7 (lines 20, 39) implement the `Edible` interface. The relationship between the class and the interface is known as *interface inheritance*. Since interface inheritance and class inheritance are essentially the same, we will simply refer to both as *inheritance*.

interface inheritance

LISTING 15.7 TestEdible.java

```
1 public class TestEdible {
2     public static void main(String[] args) {
3         Object[] objects = {new Tiger(), new Chicken(), new Apple()};
4         for (int i = 0; i < objects.length; i++) {
5             if (objects[i] instanceof Edible)
6                 System.out.println(((Edible)objects[i]).howToEat());
7
8             if (objects[i] instanceof Animal) {
9                 System.out.println(((Animal)objects[i]).sound());
10            }
11        }
12    }
13 }
```

```

11     }
12 }
13 }
14
15 abstract class Animal {                                Animal class
16     /** Return animal sound */
17     public abstract String sound();
18 }
19
20 class Chicken extends Animal implements Edible {        implements Edible
21     @Override
22     public String howToEat() {                            howToEat()
23         return "Chicken: Fry it";
24     }
25
26     @Override
27     public String sound() {
28         return "Chicken: cock-a-doodle-doo";
29     }
30 }
31
32 class Tiger extends Animal {                                Tiger class
33     @Override
34     public String sound() {
35         return "Tiger: RROOAARR";
36     }
37 }
38
39 abstract class Fruit implements Edible {                implements Edible
40     // Data fields, constructors, and methods omitted here
41 }
42
43 class Apple extends Fruit {                                Apple class
44     @Override
45     public String howToEat() {
46         return "Apple: Make apple cider";
47     }
48 }
49
50 class Orange extends Fruit {                                Orange class
51     @Override
52     public String howToEat() {
53         return "Orange: Make orange juice";
54     }
55 }

```

```

Tiger: RROOAARR
Chicken: Fry it
Chicken: cock-a-doodle-doo
Apple: Make apple cider

```



This example uses several classes and interfaces. Their inheritance relationship is shown in Figure 15.4.

The **Animal** class defines the **sound** method (line 17). It is an abstract method and will be implemented by a concrete animal class.

The **Chicken** class implements **Edible** to specify that chickens are edible. When a class implements an interface, it implements all the methods defined in the interface with the exact

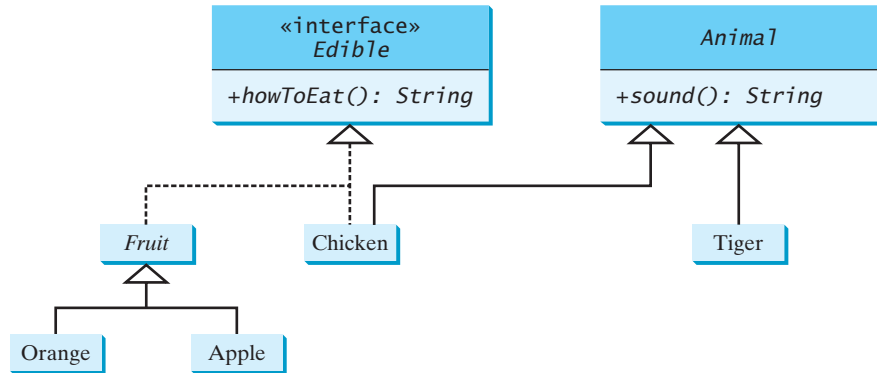


FIGURE 15.4 `Edible` is a supertype for `Chicken` and `Fruit`. `Animal` is a supertype for `Chicken` and `Tiger`. `Fruit` is a supertype for `Orange` and `Apple`.

signature and return type. The `Chicken` class implements the `howToEat` method (lines 22–24). `Chicken` also extends `Animal` to implement the `sound` method (lines 27–29).

The `Fruit` class implements `Edible`. Since it does not implement the `howToEat` method, `Fruit` must be denoted as `abstract` (line 39). The concrete subclasses of `Fruit` must implement the `howToEat` method. The `Apple` and `Orange` classes implement the `howToEat` method (lines 45, 52).

The `main` method creates an array with three objects for `Tiger`, `Chicken`, and `Apple` (line 3), and invokes the `howToEat` method if the element is edible (line 6) and the `sound` method if the element is an animal (line 9).

common behavior

In essence, the `Edible` interface defines common behavior for edible objects. All edible objects have the `howToEat` method.



Note

Since all data fields are `public static final` and all methods are `public abstract` in an interface, Java allows these modifiers to be omitted. Therefore the following interface definitions are equivalent:

omitting modifiers

```
public interface T {
    public static final int K = 1;
    public abstract void p();
}
```

Equivalent

```
public interface T {
    int K = 1;
    void p();
}
```



Tip

A constant defined in an interface can be accessed using the syntax `InterfaceName.CONSTANT_NAME` (e.g., `T.K`). It is a good practice to define common constants that are shared by many classes in an interface. For example, the constants `LEFT`, `CENTER`, `RIGHT`, `LEADING`, `TRAILING`, `TOP`, and `BOTTOM` used in `AbstractButton` are also used in many other Swing components. These constants are centrally defined in the `javax.swing.SwingConstants` interface. All Swing GUI components implement `SwingConstants`. You can reference the constants through `SwingConstants` or a GUI component. For example, `SwingConstants.CENTER` is the same as `JButton.CENTER`.

accessing constants

SwingConstants



15.14 Suppose `A` is an interface. Can you declare a reference variable `x` with type `A` like this?

```
A x;
```

15.15 Which of the following is a correct interface?

```
interface A {
    void print() { };
}
```

(a)

```
abstract interface A extends I1, I2 {
    abstract void print() { };
}
```

(b)

```
abstract interface A {
    print();
}
```

(c)

```
interface A {
    void print();
}
```

(d)

15.16 Explain why `SwingConstants.LEFT`, `AbstractButton.LEFT`, `JButton.LEFT`, `JCheckBox.LEFT`, `JRadioButton.LEFT`, and `JLabel.LEFT` all have the same value.

15.6 The Comparable Interface

The `Comparable` interface defines the `compareTo` method for comparing objects.



Suppose you want to design a generic method to find the larger of two objects of the same type, such as two students, two dates, two circles, two rectangles, or two squares. In order to accomplish this, the two objects must be comparable, so the common behavior for the objects must be comparable. Java provides the `Comparable` interface for this purpose. The interface is defined as follows:

```
// Interface for comparing objects, defined in java.lang
package java.lang;
```

```
java.lang.Comparable
```

```
public interface Comparable<E> {
    public int compareTo(E o);
}
```

The `compareTo` method determines the order of this object with the specified object `o` and returns a negative integer, zero, or a positive integer if this object is less than, equal to, or greater than `o`.

The `Comparable` interface is a generic interface. The generic type `E` is replaced by a concrete type when implementing this interface. Many classes in the Java library implement `Comparable` to define a natural order for objects. The classes `Byte`, `Short`, `Integer`, `Long`, `Float`, `Double`, `Character`, `BigInteger`, `BigDecimal`, `Calendar`, `String`, and `Date` all implement the `Comparable` interface. For example, the `Integer`, `BigInteger`, `String`, and `Date` classes are defined as follows in the Java API:

```
public class Integer extends Number
    implements Comparable<Integer> {
    // class body omitted

    @Override
    public int compareTo(Integer o) {
        // Implementation omitted
    }
}
```

```
public class BigInteger extends Number
    implements Comparable<BigInteger> {
    // class body omitted

    @Override
    public int compareTo(BigInteger o) {
        // Implementation omitted
    }
}
```

```
public class String extends Object
    implements Comparable<String> {
    // class body omitted

    @Override
    public int compareTo(String o) {
        // Implementation omitted
    }
}
```

```
public class Date extends Object
    implements Comparable<Date> {
    // class body omitted

    @Override
    public int compareTo(Date o) {
        // Implementation omitted
    }
}
```

Thus, numbers are comparable, strings are comparable, and so are dates. You can use the `compareTo` method to compare two numbers, two strings, and two dates. For example, the following code

```
1 System.out.println(new Integer(3).compareTo(new Integer(5)));
2 System.out.println("ABC".compareTo("ABE"));
3 java.util.Date date1 = new java.util.Date(2013, 1, 1);
4 java.util.Date date2 = new java.util.Date(2012, 1, 1);
5 System.out.println(date1.compareTo(date2));
```

displays

```
-1
-2
1
```

Line 1 displays a negative value since `3` is less than `5`. Line 2 displays a negative value since `ABC` is less than `ABE`. Line 5 displays a positive value since `date1` is greater than `date2`.

Let `n` be an `Integer` object, `s` be a `String` object, and `d` be a `Date` object. All the following expressions are `true`.

```
n instanceof Integer
n instanceof Object
n instanceof Comparable
```

```
s instanceof String
s instanceof Object
s instanceof Comparable
```

```
d instanceof java.util.Date
d instanceof Object
d instanceof Comparable
```

Since all `Comparable` objects have the `compareTo` method, the `java.util.Arrays.sort(Object[])` method in the Java API uses the `compareTo` method to compare and sorts the objects in an array, provided that the objects are instances of the `Comparable` interface. Listing 15.8 gives an example of sorting an array of strings and an array of `BigInteger` objects.

LISTING 15.8 SortComparableObjects.java

create an array
sort the array

```
1 import java.math.*;
2
3 public class SortComparableObjects {
4     public static void main(String[] args) {
5         String[] cities = {"Savannah", "Boston", "Atlanta", "Tampa"};
6         java.util.Arrays.sort(cities);
7         for (String city: cities)
8             System.out.print(city + " ");
9         System.out.println();
10
11         BigInteger[] hugeNumbers = {new BigInteger("2323231092923992"),
```

create an array

```

12     new BigInteger("432232323239292"),
13     new BigInteger("54623239292");
14     java.util.Arrays.sort(hugeNumbers);
15     for (BigInteger number: hugeNumbers)
16         System.out.print(number + " ");
17     }
18 }

```

sort the array

Atlanta Boston Savannah Tampa
 54623239292 432232323239292 2323231092923992



The program creates an array of strings (line 5) and invokes the `sort` method to sort the strings (line 6). The program creates an array of `BigInteger` objects (lines 11–13) and invokes the `sort` method to sort the `BigInteger` objects (line 14).

You cannot use the `sort` method to sort an array of `Rectangle` objects, because `Rectangle` does not implement `Comparable`. However, you can define a new rectangle class that implements `Comparable`. The instances of this new class are comparable. Let this new class be named `ComparableRectangle`, as shown in Listing 15.9.

LISTING 15.9 `ComparableRectangle.java`

```

1  public class ComparableRectangle extends Rectangle
2     implements Comparable<ComparableRectangle> {
3     /** Construct a ComparableRectangle with specified properties */
4     public ComparableRectangle(double width, double height) {
5         super(width, height);
6     }
7
8     @Override // Implement the compareTo method defined in Comparable
9     public int compareTo(ComparableRectangle o) {
10        if (getArea() > o.getArea())
11            return 1;
12        else if (getArea() < o.getArea())
13            return -1;
14        else
15            return 0;
16    }
17
18    @Override // Implement the toString method in GeometricObject
19    public String toString() {
20        return super.toString() + " Area: " + getArea();
21    }
22 }

```

implements Comparable

implement compareTo

implement toString

`ComparableRectangle` extends `Rectangle` and implements `Comparable`, as shown in Figure 15.5. The keyword `implements` indicates that `ComparableRectangle` inherits all the constants from the `Comparable` interface and implements the methods in the interface. The `compareTo` method compares the areas of two rectangles. An instance of `ComparableRectangle` is also an instance of `Rectangle`, `GeometricObject`, `Object`, and `Comparable`.

You can now use the `sort` method to sort an array of `ComparableRectangle` objects, as in Listing 15.10.

Notation:

The interface name and the method names are italicized. The dashed lines and hollow triangles are used to point to the interface.

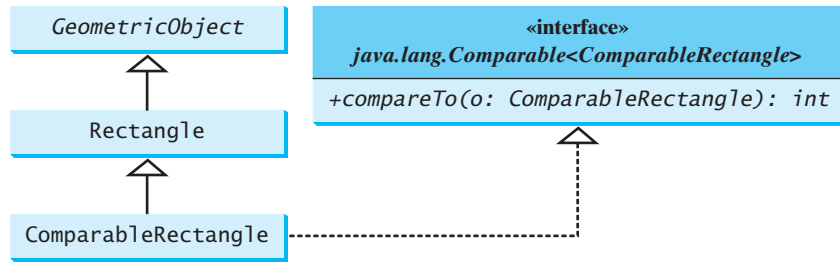


FIGURE 15.5 `ComparableRectangle` extends `Rectangle` and implements `Comparable`.

LISTING 15.10 SortRectangles.java

```

1 public class SortRectangles {
2     public static void main(String[] args) {
3         ComparableRectangle[] rectangles = {
4             new ComparableRectangle(3.4, 5.4),
5             new ComparableRectangle(13.24, 55.4),
6             new ComparableRectangle(7.4, 35.4),
7             new ComparableRectangle(1.4, 25.4)};
8         java.util.Arrays.sort(rectangles);
9         for (Rectangle rectangle: rectangles) {
10            System.out.print(rectangle + " ");
11            System.out.println();
12        }
13    }
14 }

```

create an array

sort the array



```

Width: 3.4 Height: 5.4 Area: 18.36
Width: 1.4 Height: 25.4 Area: 35.559999999999995
Width: 7.4 Height: 35.4 Area: 261.96
Width: 13.24 Height: 55.4 Area: 733.496

```

benefits of interface

An interface provides another form of generic programming. It would be difficult to use a generic `sort` method to sort the objects without using an interface in this example, because multiple inheritance would be necessary to inherit `Comparable` and another class, such as `Rectangle`, at the same time.

The `Object` class contains the `equals` method, which is intended for the subclasses of the `Object` class to override in order to compare whether the contents of the objects are the same. Suppose that the `Object` class contains the `compareTo` method, as defined in the `Comparable` interface; the `sort` method can be used to compare a list of *any* objects. Whether a `compareTo` method should be included in the `Object` class is debatable. Since the `compareTo` method is not defined in the `Object` class, the `Comparable` interface is defined in Java to enable objects to be compared if they are instances of the `Comparable` interface. It is strongly recommended (though not required) that `compareTo` should be consistent with `equals`. That is, for two objects `o1` and `o2`, `o1.compareTo(o2) == 0` if and only if `o1.equals(o2)` is `true`.



MyProgrammingLab™

15.17 True or false? If a class implements `Comparable`, the object of the class can invoke the `compareTo` method.

15.18 Which of the following is the correct method header for the `compareTo` method in the `String` class?

```
public int compareTo(String o)
public int compareTo(Object o)
```

15.19 Can the following code be compiled? Why?

```
Integer n1 = new Integer(3);
Object n2 = new Integer(4);
System.out.println(n1.compareTo(n2));
```

15.20 You can define the `compareTo` method in a class without implementing the `Comparable` interface. What are the benefits of implementing the `Comparable` interface?

15.21 True or false? If a class implements `Comparable`, the object of the class can invoke the `compareTo` method.

15.7 The Cloneable Interface

The `Cloneable` interface defines the `compareTo` method for comparing objects.



Often it is desirable to create a copy of an object. To do this, you need to use the `clone` method and understand the `Cloneable` interface.

An interface contains constants and abstract methods, but the `Cloneable` interface is a special case. The `Cloneable` interface in the `java.lang` package is defined as follows:

```
package java.lang;
```

```
java.lang.Cloneable
```

```
public interface Cloneable {
}
```

This interface is empty. An interface with an empty body is referred to as a *marker interface*. A marker interface does not contain constants or methods. It is used to denote that a class possesses certain desirable properties. A class that implements the `Cloneable` interface is marked cloneable, and its objects can be cloned using the `clone()` method defined in the `Object` class.

marker interface

Many classes in the Java library (e.g., `Date`, `Calendar`, and `ArrayList`) implement `Cloneable`. Thus, the instances of these classes can be cloned. For example, the following code

```
1 Calendar calendar = new GregorianCalendar(2013, 2, 1);
2 Calendar calendar1 = calendar;
3 Calendar calendar2 = (Calendar)calendar.clone();
4 System.out.println("calendar == calendar1 is " +
5   (calendar == calendar1));
6 System.out.println("calendar == calendar2 is " +
7   (calendar == calendar2));
8 System.out.println("calendar.equals(calendar2) is " +
9   calendar.equals(calendar2));
```

displays

```
calendar == calendar1 is true
calendar == calendar2 is false
calendar.equals(calendar2) is true
```

In the preceding code, line 2 copies the reference of `calendar` to `calendar1`, so `calendar` and `calendar1` point to the same `Calendar` object. Line 3 creates a new object that is the

clone of `calendar` and assigns the new object's reference to `calendar2`. `calendar2` and `calendar` are different objects with the same contents.

The following code

```

1 ArrayList<Double> list1 = new ArrayList<Double>();
2 list1.add(1.5);
3 list1.add(2.5);
4 list1.add(3.5);
5 ArrayList<Double> list2 = (ArrayList<Double>)list1.clone();
6 ArrayList<Double> list3 = list1;
7 list2.add(4.5);
8 list3.remove(1.5);
9 System.out.println("list1 is " + list1);
10 System.out.println("list2 is " + list2);
11 System.out.println("list3 is " + list3);

```

displays

```

list1 is [2.5, 3.5]
list2 is [1.5, 2.5, 3.5, 4.5]
list3 is [2.5, 3.5]

```

In the preceding code, line 5 creates a new object that is the clone of `list1` and assigns the new object's reference to `list2`. `list2` and `list1` are different objects with the same contents. Line 6 copies the reference of `list1` to `list3`, so `list1` and `list3` point to the same `ArrayList` object. Line 7 adds `4.5` into `list2`. Line 8 removes `1.5` from `list3`. Since `list1` and `list3` point to the same `ArrayList`, line 9 and 11 display the same content.

clone arrays

You can clone an array using the `clone` method. For example, the following code

```

1 int[] list1 = {1, 2};
2 int[] list2 = list1.clone();
3 list1[0] = 7;
4 list2[1] = 8;
5 System.out.println("list1 is " + list1[0] + ", " + list1[1]);
6 System.out.println("list2 is " + list2[0] + ", " + list2[1]);

```

displays

```

list1 is 7, 2
list2 is 1, 8

```

how to implement Cloneable

To define a custom class that implements the `Cloneable` interface, the class must override the `clone()` method in the `Object` class. Listing 15.11 defines a class named `House` that implements `Cloneable` and `Comparable`.

LISTING 15.11 House.java

```

1 public class House implements Cloneable, Comparable<House> {
2     private int id;
3     private double area;
4     private java.util.Date whenBuilt;
5
6     public House(int id, double area) {
7         this.id = id;
8         this.area = area;
9         whenBuilt = new java.util.Date();
10    }
11
12    public int getId() {

```

```

13     return id;
14 }
15
16 public double getArea() {
17     return area;
18 }
19
20 public java.util.Date getWhenBuilt() {
21     return whenBuilt;
22 }
23
24 @Override /** Override the protected clone method defined in
25     the Object class, and strengthen its accessibility */
26 public Object clone() throws CloneNotSupportedException {
27     return super.clone();
28 }
29
30 @Override // Implement the compareTo method defined in Comparable
31 public int compareTo(House o) {
32     if (area > o.area)
33         return 1;
34     else if (area < o.area)
35         return -1;
36     else
37         return 0;
38 }
39 }

```

This exception is thrown if
House does not implement
Cloneable

The `House` class implements the `clone` method (lines 26–28) defined in the `Object` class. The header is:

```
protected native Object clone() throws CloneNotSupportedException;
```

The keyword `native` indicates that this method is not written in Java but is implemented in the JVM for the native platform. The keyword `protected` restricts the method to be accessed in the same package or in a subclass. For this reason, the `House` class must override the method and change the visibility modifier to `public` so that the method can be used in any package. Since the `clone` method implemented for the native platform in the `Object` class performs the task of cloning objects, the `clone` method in the `House` class simply invokes `super.clone()`. The `clone` method defined in the `Object` class may throw `CloneNotSupportedException`.

CloneNotSupportedException

The `House` class implements the `compareTo` method (lines 31–38) defined in the `Comparable` interface. The method compares the areas of two houses.

You can now create an object of the `House` class and create an identical copy from it, as follows:

```
House house1 = new House(1, 1750.50);
House house2 = (House)house1.clone();
```

`house1` and `house2` are two different objects with identical contents. The `clone` method in the `Object` class copies each field from the original object to the target object. If the field is of a primitive type, its value is copied. For example, the value of `area` (`double` type) is copied from `house1` to `house2`. If the field is of an object, the reference of the field is copied. For example, the field `whenBuilt` is of the `Date` class, so its reference is copied into `house2`, as shown in Figure 15.6. Therefore, `house1.whenBuilt == house2.whenBuilt` is true, although `house1 == house2` is false. This is referred to as a *shallow copy* rather than a *deep copy*, meaning that if the field is of an object type, the object's reference is copied rather than its contents.

shallow copy
deep copy

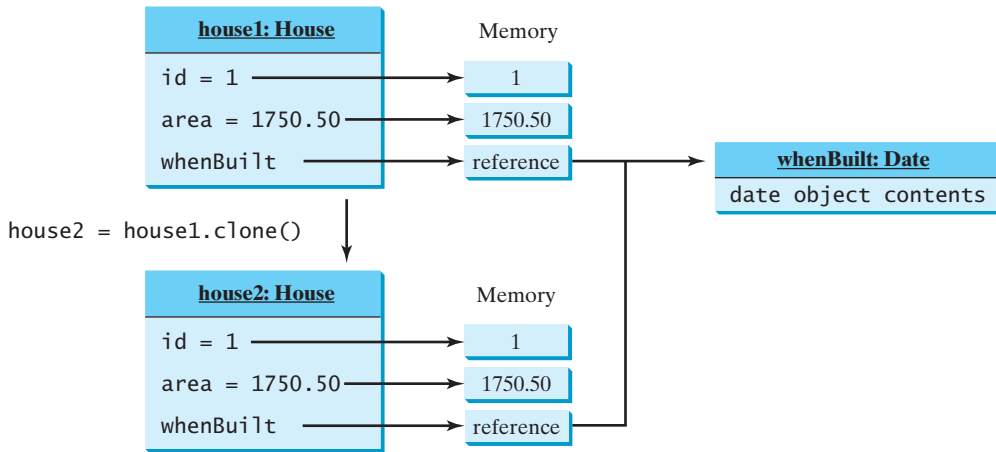


FIGURE 15.6 The default `clone` method performs a shallow copy.

deep copy

To perform a deep copy for a `House` object, replace the `clone()` method in lines 26–27 with the following code:

```
public Object clone() throws CloneNotSupportedException {
    // Perform a shallow copy
    House houseClone = (House)super.clone();
    // Deep copy on whenBuilt
    houseClone.whenBuilt = (java.util.Date)(whenBuilt.clone());
    return houseClone;
}
```

or

```
public Object clone() {
    try {
        // Perform a shallow copy
        House houseClone = (House)super.clone();
        // Deep copy on whenBuilt
        houseClone.whenBuilt = (java.util.Date)(whenBuilt.clone());
        return houseClone;
    }
    catch (CloneNotSupportedException ex) {
        return null;
    }
}
```

Now if you clone a `House` object in the following code:

```
House house1 = new House(1, 1750.50);
House house2 = (House)house1.clone();
```

`house1.whenBuilt == house2.whenBuilt` will be `false`. `house1` and `house2` reference two different `Date` objects.



MyProgrammingLab™

15.22 Can you invoke the `clone()` method to clone an object if the class for the object does not implement the `java.lang.Cloneable`? Does the `Date` class implement `Cloneable`?

15.23 What would happen if the `House` class (defined in Listing 15.9) did not override the `clone()` method or if `House` did not implement `java.lang.Cloneable`?

15.24 Show the printout of the following code:

```
java.util.Date date = new java.util.Date();
java.util.Date date1 = date;
java.util.Date date2 = (java.util.Date)(date.clone());
System.out.println(date == date1);
System.out.println(date == date2);
System.out.println(date.equals(date2));
```

15.25 Show the printout of the following code:

```
ArrayList<String> list = new ArrayList<String>();
list.add("New York");
ArrayList<String> list1 = list;
ArrayList<String> list2 = (ArrayList<String>)(list.clone());
list.add("Atlanta");
System.out.println(list == list1);
System.out.println(list == list2);
System.out.println("list is " + list);
System.out.println("list1 is " + list1);
System.out.println("list2.get(0) is " + list2.get(0));
System.out.println("list2.size() is " + list2.size());
```

15.26 What is wrong in the following code?

```
public class Test {
    public static void main(String[] args) {
        GeometricObject x = new Circle(3);
        GeometricObject y = x.clone();
        System.out.println(x == y);
    }
}
```

15.8 Interfaces vs. Abstract Classes

A class can implement multiple interfaces, but it can only extend one superclass.



An interface can be used more or less the same way as an abstract class, but defining an interface is different from defining an abstract class. Table 15.2 summarizes the differences.

TABLE 15.2 Interfaces vs. Abstract Classes

	<i>Variables</i>	<i>Constructors</i>	<i>Methods</i>
Abstract class	No restrictions.	Constructors are invoked by subclasses through constructor chaining. An abstract class cannot be instantiated using the new operator.	No restrictions.
Interface	All variables must be public static final .	No constructors. An interface cannot be instantiated using the new operator.	All methods must be public abstract instance methods

Java allows only *single inheritance* for class extension but allows *multiple extensions* for interfaces. For example,

single inheritance

multiple inheritance

```
public class NewClass extends BaseClass
    implements Interface1, . . . , InterfaceN {
    . . .
}
```

subinterface

An interface can inherit other interfaces using the **extends** keyword. Such an interface is called a *subinterface*. For example, **NewInterface** in the following code is a subinterface of **Interface1**, . . . , and **InterfaceN**.

```
public interface NewInterface extends Interface1, . . . , InterfaceN {
    // constants and abstract methods
}
```

A class implementing **NewInterface** must implement the abstract methods defined in **NewInterface**, **Interface1**, . . . , and **InterfaceN**. An interface can extend other interfaces but not classes. A class can extend its superclass and implement multiple interfaces.

All classes share a single root, the **Object** class, but there is no single root for interfaces. Like a class, an interface also defines a type. A variable of an interface type can reference any instance of the class that implements the interface. If a class implements an interface, the interface is like a superclass for the class. You can use an interface as a data type and cast a variable of an interface type to its subclass, and vice versa. For example, suppose that **c** is an instance of **Class2** in Figure 15.7. **c** is also an instance of **Object**, **Class1**, **Interface1**, **Interface1_1**, **Interface1_2**, **Interface2_1**, and **Interface2_2**.

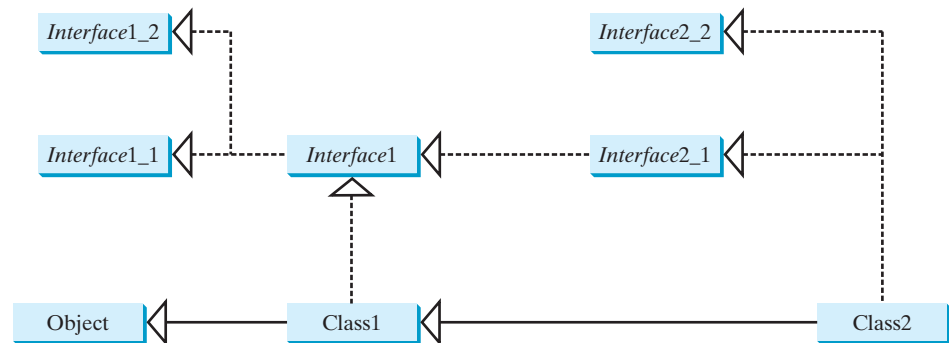


FIGURE 15.7 **Class1** implements **Interface1**; **Interface1** extends **Interface1_1** and **Interface1_2**. **Class2** extends **Class1** and implements **Interface2_1** and **Interface2_2**.

naming convention



Note

Class names are nouns. Interface names may be adjectives or nouns.

is-a relationship

is-kind-of relationship



Design Guide

Abstract classes and interfaces can both be used to specify common behavior of objects. How do you decide whether to use an interface or a class? In general, a *strong is-a relationship* that clearly describes a parent-child relationship should be modeled using classes. For example, Gregorian calendar is a calendar, so the relationship between the class **java.util.GregorianCalendar** and **java.util.Calendar** is modeled using class inheritance. A *weak is-a relationship*, also known as an *is-kind-of relationship*, indicates that an object possesses a certain property. A weak is-a relationship can be modeled using interfaces. For example, all strings are comparable, so the **String** class implements the **Comparable** interface.

interface preferred

In general, interfaces are preferred over abstract classes because an interface can define a common supertype for unrelated classes. Interfaces are more flexible than

classes. Consider the `Animal` class. Suppose the `howToEat` method is defined in the `Animal` class, as follows:

```
abstract class Animal {
    public abstract String howToEat();
}
```

Animal class

Two subclasses of `Animal` are defined as follows:

```
class Chicken extends Animal {
    @Override
    public String howToEat() {
        return "Fry it";
    }
}
```

Chicken class

```
class Duck extends Animal {
    @Override
    public String howToEat() {
        return "Roast it";
    }
}
```

Duck class

Given this inheritance hierarchy, polymorphism enables you to hold a reference to a `Chicken` object or a `Duck` object in a variable of type `Animal`, as in the following code:

```
public static void main(String[] args) {
    Animal animal = new Chicken();
    eat(animal);

    animal = new Duck();
    eat(animal);
}

public static void eat(Animal animal) {
    animal.howToEat();
}
```

The JVM dynamically decides which `howToEat` method to invoke based on the actual object that invokes the method.

You can define a subclass of `Animal`. However, there is a restriction: The subclass must be for another animal (e.g., `Turkey`).

Interfaces don't have this restriction. Interfaces give you more flexibility than classes, because you don't have to make everything fit into one type of class. You may define the `howToEat()` method in an interface and let it serve as a common supertype for other classes. For example,

```
public static void main(String[] args) {
    Edible stuff = new Chicken();
    eat(stuff);

    stuff = new Duck();
    eat(stuff);

    stuff = new Broccoli();
    eat(stuff);
}
```

```

public static void eat(Edible stuff) {
    stuff.howToEat();
}

```

Edible interface

```

interface Edible {
    public String howToEat();
}

```

Chicken class

```

class Chicken implements Edible {
    @Override
    public String howToEat() {
        return "Fry it";
    }
}

```

Duck class

```

class Duck implements Edible {
    @Override
    public String howToEat() {
        return "Roast it";
    }
}

```

Broccoli class

```

class Broccoli implements Edible {
    @Override
    public String howToEat() {
        return "Stir-fry it";
    }
}

```

To define a class that represents edible objects, simply let the class implement the **Edible** interface. The class is now a subtype of the **Edible** type, and any **Edible** object can be passed to invoke the **eat** method.



MyProgrammingLab™

15.27 Give an example to show why interfaces are preferred over abstract classes.

15.28 Define the terms abstract classes and interfaces. What are the similarities and differences between abstract classes and interfaces?

15.28 True or false?

- An interface is compiled into a separate bytecode file.
- An interface can have static methods.
- An interface can extend one or more interfaces.
- An interface can extend an abstract class.
- An abstract class can extend an interface.

15.9 Case Study: The Rational Class



*This section shows how to design the **Rational** class for representing and processing rational numbers.*

A rational number has a numerator and a denominator in the form **a/b**, where **a** is the numerator and **b** the denominator. For example, **1/3**, **3/4**, and **10/4** are rational numbers.

A rational number cannot have a denominator of **0**, but a numerator of **0** is fine. Every integer **i** is equivalent to a rational number **i/1**. Rational numbers are used in exact computations involving fractions—for example, **1/3 = 0.33333**. . . . This number cannot be precisely represented in floating-point format using either the data type **double** or **float**. To obtain the exact result, we must use rational numbers.

Java provides data types for integers and floating-point numbers, but not for rational numbers. This section shows how to design a class to represent rational numbers.

Since rational numbers share many common features with integers and floating-point numbers, and `Number` is the root class for numeric wrapper classes, it is appropriate to define `Rational` as a subclass of `Number`. Since rational numbers are comparable, the `Rational` class should also implement the `Comparable` interface. Figure 15.8 illustrates the `Rational` class and its relationship to the `Number` class and the `Comparable` interface.

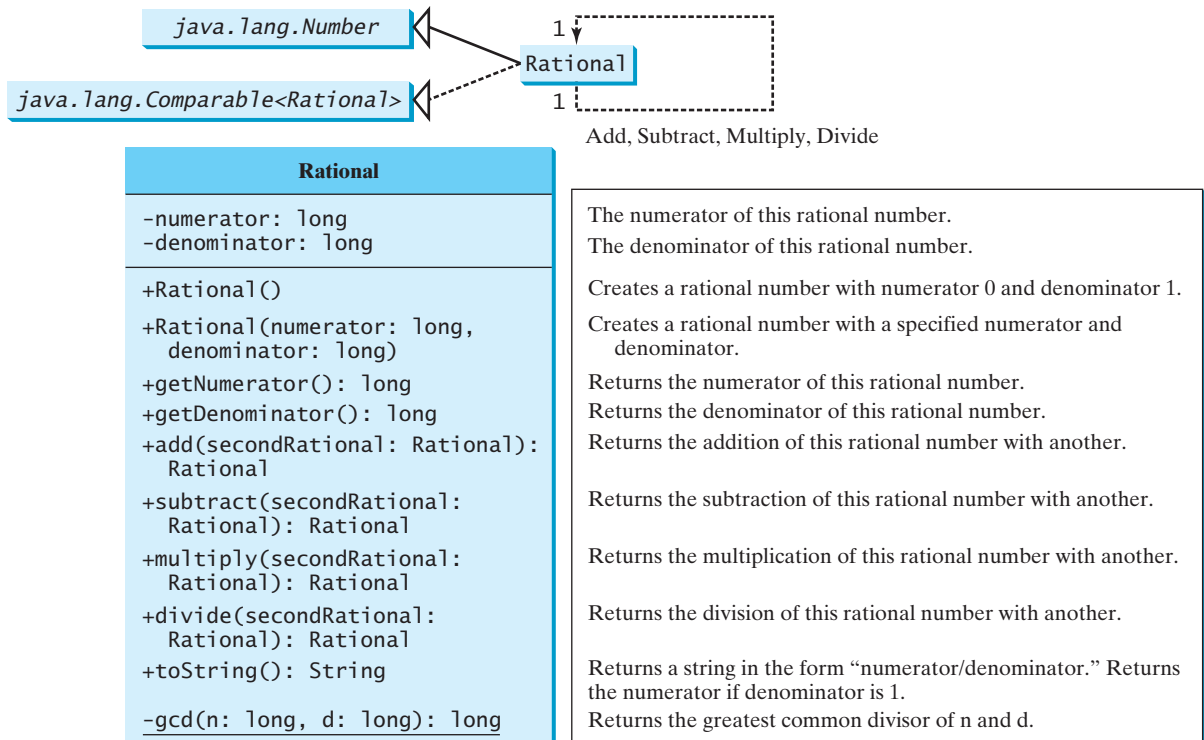


FIGURE 15.8 The properties, constructors, and methods of the `Rational` class are illustrated in UML.

A rational number consists of a numerator and a denominator. There are many equivalent rational numbers—for example, $1/3 = 2/6 = 3/9 = 4/12$. The numerator and the denominator of $1/3$ have no common divisor except 1, so $1/3$ is said to be in *lowest terms*.

To reduce a rational number to its lowest terms, you need to find the greatest common divisor (GCD) of the absolute values of its numerator and denominator, then divide both the numerator and denominator by this value. You can use the method for computing the GCD of two integers `n` and `d`, as suggested in Listing 4.9, `GreatestCommonDivisor.java`. The numerator and denominator in a `Rational` object are reduced to their lowest terms.

As usual, let us first write a test program to create two `Rational` objects and test its methods. Listing 15.12 is a test program.

LISTING 15.12 TestRationalClass.java

```

1 public class TestRationalClass {
2     /** Main method */
3     public static void main(String[] args) {
4         // Create and initialize two rational numbers r1 and r2
  
```

```

create a Rational      5      Rational r1 = new Rational(4, 2);
create a Rational      6      Rational r2 = new Rational(2, 3);
                        7
                        8      // Display results
add                    9      System.out.println(r1 + " + " + r2 + " = " + r1.add(r2));
                    10      System.out.println(r1 + " - " + r2 + " = " + r1.subtract(r2));
                    11      System.out.println(r1 + " * " + r2 + " = " + r1.multiply(r2));
                    12      System.out.println(r1 + " / " + r2 + " = " + r1.divide(r2));
                    13      System.out.println(r2 + " is " + r2.doubleValue());
                    14  }
                    15  }

```



```

2 + 2/3 = 8/3
2 - 2/3 = 4/3
2 * 2/3 = 4/3
2 / 2/3 = 3
2/3 is 0.6666666666666666

```

The `main` method creates two rational numbers, `r1` and `r2` (lines 5–6), and displays the results of `r1 + r2`, `r1 - r2`, `r1 x r2`, and `r1 / r2` (lines 9–12). To perform `r1 + r2`, invoke `r1.add(r2)` to return a new `Rational` object. Similarly, invoke `r1.subtract(r2)` for `r1 - r2`, `r1.multiply(r2)` for `r1 x r2`, and `r1.divide(r2)` for `r1 / r2`.

The `doubleValue()` method displays the double value of `r2` (line 13). The `doubleValue()` method is defined in `java.lang.Number` and overridden in `Rational`.

Note that when a string is concatenated with an object using the plus sign (+), the object's string representation from the `toString()` method is used to concatenate with the string. So `r1 + " + " + r2 + " = " + r1.add(r2)` is equivalent to `r1.toString() + " + " + r2.toString() + " = " + r1.add(r2).toString()`.

The `Rational` class is implemented in Listing 15.13.

LISTING 15.13 Rational.java

```

1  public class Rational extends Number implements Comparable<Rational> {
2      // Data fields for numerator and denominator
3      private long numerator = 0;
4      private long denominator = 1;
5
6      /** Construct a rational with default properties */
7      public Rational() {
8          this(0, 1);
9      }
10
11     /** Construct a rational with specified numerator and denominator */
12     public Rational(long numerator, long denominator) {
13         long gcd = gcd(numerator, denominator);
14         this.numerator = ((denominator > 0) ? 1 : -1) * numerator / gcd;
15         this.denominator = Math.abs(denominator) / gcd;
16     }
17
18     /** Find GCD of two numbers */
19     private static long gcd(long n, long d) {
20         long n1 = Math.abs(n);
21         long n2 = Math.abs(d);
22         int gcd = 1;

```

```

23
24     for (int k = 1; k <= n1 && k <= n2; k++) {
25         if (n1 % k == 0 && n2 % k == 0)
26             gcd = k;
27     }
28
29     return gcd;
30 }
31
32 /** Return numerator */
33 public long getNumerator() {
34     return numerator;
35 }
36
37 /** Return denominator */
38 public long getDenominator() {
39     return denominator;
40 }
41
42 /** Add a rational number to this rational */
43 public Rational add(Rational secondRational) {
44     long n = numerator * secondRational.getDenominator() +
45             denominator * secondRational.getNumerator();
46     long d = denominator * secondRational.getDenominator();
47     return new Rational(n, d);
48 }
49
50 /** Subtract a rational number from this rational */
51 public Rational subtract(Rational secondRational) {
52     long n = numerator * secondRational.getDenominator()
53             - denominator * secondRational.getNumerator();
54     long d = denominator * secondRational.getDenominator();
55     return new Rational(n, d);
56 }
57
58 /** Multiply a rational number by this rational */
59 public Rational multiply(Rational secondRational) {
60     long n = numerator * secondRational.getNumerator();
61     long d = denominator * secondRational.getDenominator();
62     return new Rational(n, d);
63 }
64
65 /** Divide a rational number by this rational */
66 public Rational divide(Rational secondRational) {
67     long n = numerator * secondRational.getDenominator();
68     long d = denominator * secondRational.numerator();
69     return new Rational(n, d);
70 }
71
72 @Override
73 public String toString() {
74     if (denominator == 1)
75         return numerator + "";
76     else
77         return numerator + "/" + denominator;
78 }
79
80 @Override // Override the equals method in the Object class
81 public boolean equals(Object other) {
82     if ((this.subtract((Rational)other)).getNumerator() == 0)

```

$$\frac{a}{b} + \frac{c}{d} = \frac{ad + bc}{bd}$$

$$\frac{a}{b} - \frac{c}{d} = \frac{ad - bc}{bd}$$

$$\frac{a}{b} \times \frac{c}{d} = \frac{ac}{bd}$$

$$\frac{a}{b} \div \frac{c}{d} = \frac{ad}{bc}$$

```

83         return true;
84     else
85         return false;
86     }
87
88     @Override // Implement the abstract intValue method in Number
89     public int intValue() {
90         return (int)doubleValue();
91     }
92
93     @Override // Implement the abstract floatValue method in Number
94     public float floatValue() {
95         return (float)doubleValue();
96     }
97
98     @Override // Implement the doubleValue method in Number
99     public double doubleValue() {
100        return numerator * 1.0 / denominator;
101    }
102
103    @Override // Implement the abstract longValue method in Number
104    public long longValue() {
105        return (long)doubleValue();
106    }
107
108    @Override // Implement the compareTo method in Comparable
109    public int compareTo(Rational o) {
110        if (this.subtract(o).getNumerator() > 0)
111            return 1;
112        else if (this.subtract(o).getNumerator() < 0)
113            return -1;
114        else
115            return 0;
116    }
117 }

```

The rational number is encapsulated in a **Rational** object. Internally, a rational number is represented in its lowest terms (line 13), and the numerator determines its sign (line 14). The denominator is always positive (line 15).

The **gcd** method (lines 19–30 in the **Rational** class) is private; it is not intended for use by clients. The **gcd** method is only for internal use by the **Rational** class. The **gcd** method is also static, since it is not dependent on any particular **Rational** object.

The **abs(x)** method (lines 20–21 in the **Rational** class) is defined in the **Math** class and returns the absolute value of **x**.

Two **Rational** objects can interact with each other to perform add, subtract, multiply, and divide operations. These methods return a new **Rational** object (lines 43–70).

The methods **toString** and **equals** in the **Object** class are overridden in the **Rational** class (lines 72–86). The **toString()** method returns a string representation of a **Rational** object in the form **numerator/denominator**, or simply **numerator** if **denominator** is **1**. The **equals(Object other)** method returns true if this rational number is equal to the other rational number.

The abstract methods **intValue**, **longValue**, **floatValue**, and **doubleValue** in the **Number** class are implemented in the **Rational** class (lines 88–106). These methods return the **int**, **long**, **float**, and **double** value for this rational number.

The **compareTo(Rational other)** method in the **Comparable** interface is implemented in the **Rational** class (lines 108–116) to compare this rational number to the other rational number.

**Tip**

The `get` methods for the properties `numerator` and `denominator` are provided in the `Rational` class, but the `set` methods are not provided, so, once a `Rational` object is created, its contents cannot be changed. The `Rational` class is immutable. The `String` class and the wrapper classes for primitive type values are also immutable.

immutable

**Tip**

The numerator and denominator are represented using two variables. It is possible to use an array of two integers to represent the numerator and denominator (see Programming Exercise 15.16). The signatures of the public methods in the `Rational` class are not changed, although the internal representation of a rational number is changed. This is a good example to illustrate the idea that the data fields of a class should be kept private so as to encapsulate the implementation of the class from the use of the class.

encapsulation

The `Rational` class has serious limitations and can easily overflow. For example, the following code will display an incorrect result, because the denominator is too large.

overflow

```
public class Test {
    public static void main(String[] args) {
        Rational r1 = new Rational(1, 123456789);
        Rational r2 = new Rational(1, 123456789);
        Rational r3 = new Rational(1, 123456789);
        System.out.println("r1 * r2 * r3 is " +
            r1.multiply(r2.multiply(r3)));
    }
}
```

```
r1 * r2 * r3 is -1/2204193661661244627
```



To fix it, you can implement the `Rational` class using the `BigInteger` for numerator and denominator (see Programming Exercise 15.21).

15.30 Show the printout of the following code?

```
Rational r1 = new Rational(-2, 6);
System.out.println(r1.getNumerator());
System.out.println(r1.getDenominator());
System.out.println(r1.intValue());
System.out.println(r1.doubleValue());
```



Check
Point
MyProgrammingLab™

15.31 Why is the following code wrong?

```
Rational r1 = new Rational(-2, 6);
Object r2 = new Rational(1, 45);
System.out.println(r2.compareTo(r1));
```

15.32 Why is the following code wrong?

```
Object r1 = new Rational(-2, 6);
Rational r2 = new Rational(1, 45);
System.out.println(r2.compareTo(r1));
```

KEY TERMS

abstract class	560	marker interface	577
abstract method	560	shallow copy	579
deep copy	579	subinterface	582
interface	560		

CHAPTER SUMMARY

1. *Abstract classes* are like regular classes with data and methods, but you cannot create instances of abstract classes using the `new` operator.
2. An *abstract method* cannot be contained in a nonabstract class. If a subclass of an abstract superclass does not implement all the inherited abstract methods of the superclass, the subclass must be defined as abstract.
3. A class that contains abstract methods must be abstract. However, it is possible to define an abstract class that doesn't contain any abstract methods.
4. A subclass can be abstract even if its superclass is concrete.
5. An *interface* is a class-like construct that contains only constants and abstract methods. In many ways, an interface is similar to an abstract class, but an abstract class can contain constants and abstract methods as well as variables and concrete methods.
6. An interface is treated like a special class in Java. Each interface is compiled into a separate bytecode file, just like a regular class.
7. The `java.lang.Comparable` interface defines the `compareTo` method. Many classes in the Java library implement `Comparable`.
8. The `java.lang.Cloneable` interface is a *marker interface*. An object of the class that implements the `Cloneable` interface is cloneable.
9. A class can extend only one superclass but can implement one or more interfaces.
10. An interface can extend one or more interfaces.

TEST QUESTIONS

Do the test questions for this chapter online at www.cs.armstrong.edu/liang/intro9e/test.html.

PROGRAMMING EXERCISES

Sections 15.2–15.3

- **15.1** (*Plot functions using abstract methods*) Write an abstract class that draws the diagram for a function. The class is defined as follows:

```
public abstract class AbstractDrawFunction extends JPanel {
    /** Polygon to hold the points */
    private Polygon p = new Polygon();
```

```

protected AbstractDrawFunction () {
    drawFunction();
}

/** Return the y-coordinate */
abstract double f(double x);

/** Obtain points for x-coordinates 100, 101, . . . , 300 */
public void drawFunction() {
    for (int x = -100; x <= 100; x++) {
        p.addPoint(x + 200, 200 - (int)f(x));
    }
}

@Override /** Draw axes, labels, and connect points */
protected void paintComponent(Graphics g) {
    // To be completed by you
}
}

```

Test the class with the following functions:

- $f(x) = x^2$;
- $f(x) = \sin(x)$;
- $f(x) = \cos(x)$;
- $f(x) = \tan(x)$;
- $f(x) = \cos(x) + 5\sin(x)$;
- $f(x) = 5\cos(x) + \sin(x)$;
- $f(x) = \log(x) + x^2$;

For each function, create a class that extends the `AbstractDrawFunction` class and implements the `f` method. Figure 15.9 displays the drawings for the first three functions.

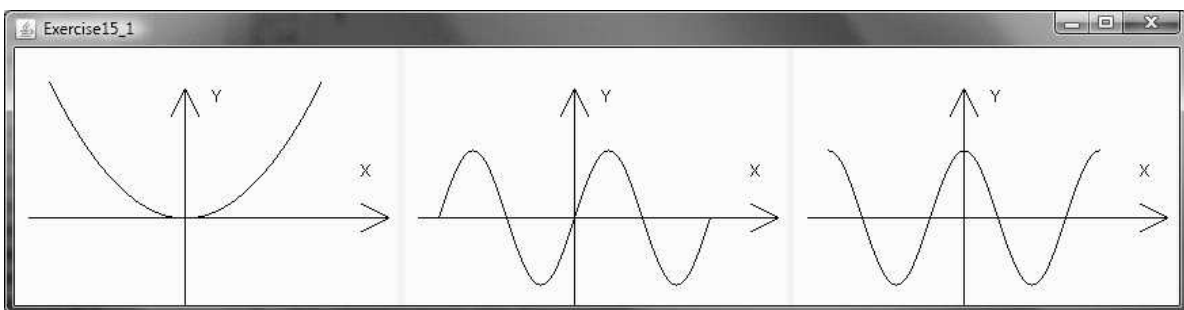


FIGURE 15.9 Exercise 15.1 draws the square, sine, and cosine functions.

- **15.2** (*Triangle class*) Design a new `Triangle` class that extends the abstract `GeometricObject` class. Draw the UML diagram for the classes `Triangle` and `GeometricObject` and then implement the `Triangle` class. Write a test program that prompts the user to enter three sides of the triangle, a color, and a Boolean value to indicate whether the triangle is filled. The program should create a `Triangle` object with these sides and set the color and filled properties using the input. The program should display the area, perimeter, color, and true or false to indicate whether it is filled or not.

***15.3** (*Shuffle ArrayList*) Write the following method that shuffles an `ArrayList` of numbers:

```
public static void shuffle(ArrayList<Number> list)
```

***15.4** (*Sort ArrayList*) Write the following method that sorts an `ArrayList` of numbers.

```
public static void sort(ArrayList<Number> list)
```

****15.5** (*Display a calendar*) Write a program that displays the calendar for the current month, as shown in Figure 15.10. Use labels, and set text on the labels to display the calendar. Use the `GregorianCalendar` class to obtain the information for the month, year, first day of the month, and number of days in the month.



FIGURE 15.10 The program displays the calendar for the current month.

****15.6** (*Display calendars*) Rewrite the `PrintCalendar` class in Listing 5.12 to display a calendar for a specified month using the `Calendar` and `GregorianCalendar` classes. Your program receives the month and year from the command line. For example:

```
java Exercise15_06 1 2012
```

This displays the calendar shown in Figure 15.11.

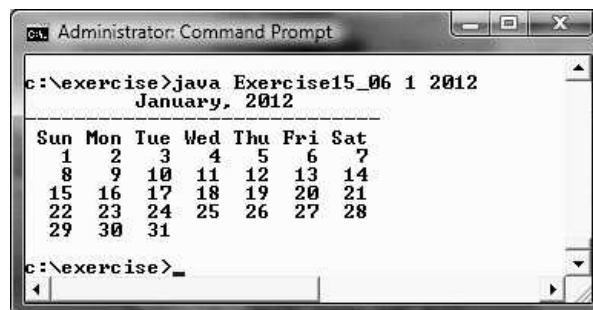


FIGURE 15.11 The program displays a calendar for January 2012.

You also can run the program without the year. In this case, the year is the current year. If you run the program without specifying a month and a year, the month is the current month.

Sections 15.4–15.8

- *15.7 (Enable *GeometricObject* comparable) Modify the **GeometricObject** class to implement the **Comparable** interface, and define a static **max** method in the **GeometricObject** class for finding the larger of two **GeometricObject** objects. Draw the UML diagram and implement the new **GeometricObject** class. Write a test program that uses the **max** method to find the larger of two circles and the larger of two rectangles.
- *15.8 (The *ComparableCircle* class) Define a class named **ComparableCircle** that extends **Circle** and implements **Comparable**. Draw the UML diagram and implement the **compareTo** method to compare the circles on the basis of area. Write a test class to find the larger of two instances of **ComparableCircle** objects.
- *15.9 (The *Colorable* interface) Design an interface named **Colorable** with a **void** method named **howToColor()**. Every class of a colorable object must implement the **Colorable** interface. Design a class named **Square** that extends **GeometricObject** and implements **Colorable**. Implement **howToColor** to display the message **Color all four sides**.
Draw a UML diagram that involves **Colorable**, **Square**, and **GeometricObject**. Write a test program that creates an array of five **GeometricObject**s. For each object in the array, invoke its **howToColor** method if it is colorable.
- *15.10 (Revise the *MyStack* class) Rewrite the **MyStack** class in Listing 11.9 to perform a deep copy of the **list** field.
- *15.11 (Enable *Circle* comparable) Rewrite the **Circle** class in Listing 15.2 to extend **GeometricObject** and implement the **Comparable** interface. Override the **equals** method in the **Object** class. Two **Circle** objects are equal if their radii are the same. Draw the UML diagram that involves **Circle**, **GeometricObject**, and **Comparable**.
- *15.12 (Enable *Rectangle* comparable) Rewrite the **Rectangle** class in Listing 15.3 to extend **GeometricObject** and implement the **Comparable** interface. Override the **equals** method in the **Object** class. Two **Rectangle** objects are equal if their areas are the same. Draw the UML diagram that involves **Rectangle**, **GeometricObject**, and **Comparable**.
- *15.13 (The *Octagon* class) Write a class named **Octagon** that extends **GeometricObject** and implements the **Comparable** and **Cloneable** interfaces. Assume that all eight sides of the octagon are of equal size. The area can be computed using the following formula:

$$\text{area} = (2 + 4/\sqrt{2}) * \text{side} * \text{side}$$

Draw the UML diagram that involves **Octagon**, **GeometricObject**, **Comparable**, and **Cloneable**. Write a test program that creates an **Octagon** object with side value **5** and displays its area and perimeter. Create a new object using the **clone** method and compare the two objects using the **compareTo** method.

- *15.14 (Sum the areas of geometric objects) Write a method that sums the areas of all the geometric objects in an array. The method signature is:

```
public static double sumArea(GeometricObject[] a)
```

Write a test program that creates an array of four objects (two circles and two rectangles) and computes their total area using the **sumArea** method.



VideoNote

Redesign the **Rectangle** class

- *15.15 (Enable the `Course` class cloneable) Rewrite the `Course` class in Listing 10.6 to add a `clone` method to perform a deep copy on the `students` field.

Section 15.9

- *15.16 (Demonstrate the benefits of encapsulation) Rewrite the `Rational` class in Listing 15.13 using a new internal representation for the numerator and denominator. Create an array of two integers as follows:

```
private long[] r = new long[2];
```

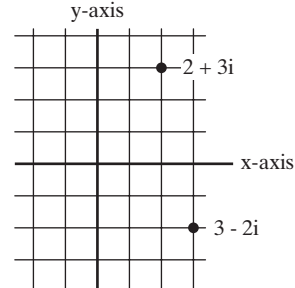
Use `r[0]` to represent the numerator and `r[1]` to represent the denominator. The signatures of the methods in the `Rational` class are not changed, so a client application that uses the previous `Rational` class can continue to use this new `Rational` class without being recompiled.

- *15.17 (Use `BigInteger` for the `Rational` class) Redesign and implement the `Rational` class in Listing 15.11 using `BigInteger` for the numerator and denominator.

- *15.18 (Create a rational-number calculator) Write a program similar to Listing 9.5, `Calculator.java`. Instead of using integers, use rationals, as shown in Figure 15.12a. You will need to use the `split` method in the `String` class, introduced in Section 9.2.6, Converting, Replacing, and Splitting Strings, to retrieve the numerator string and denominator string, and convert strings into integers using the `Integer.parseInt` method.

```
Administrator: Command Prompt
c:\exercise>java Exercise15_18 "3/4 + 1/5"
3/4 + 1/5 = 19/20
c:\exercise>java Exercise15_18 "3/4 - 1/5"
3/4 - 1/5 = 11/20
c:\exercise>java Exercise15_18 "3/4 * 1/5"
3/4 * 1/5 = 3/20
c:\exercise>
```

(a)



(b)

FIGURE 15.12 (a) The program takes three arguments (operand1, operator, and operand2) from the command line and displays the expression and the result of the arithmetic operation. (b) A complex number can be interpreted as a point in a plane.

- *15.19 (Math: The `Complex` class) A complex number is a number in the form $a + bi$, where a and b are real numbers and i is $\sqrt{-1}$. The numbers a and b are known as the real part and imaginary part of the complex number, respectively. You can perform addition, subtraction, multiplication, and division for complex numbers using the following formulas:

$$a + bi + c + di = (a + c) + (b + d)i$$

$$a + bi - (c + di) = (a - c) + (b - d)i$$

$$(a + bi) * (c + di) = (ac - bd) + (bc + ad)i$$

$$(a + bi)/(c + di) = (ac + bd)/(c^2 + d^2) + (bc - ad)i/(c^2 + d^2)$$

You can also obtain the absolute value for a complex number using the following formula:

$$|a + bi| = \sqrt{a^2 + b^2}$$

(A complex number can be interpreted as a point on a plane by identifying the (a,b) values as the coordinates of the point. The absolute value of the complex number corresponds to the distance of the point to the origin, as shown in Figure 15.12b.)

Design a class named `Complex` for representing complex numbers and the methods `add`, `subtract`, `multiply`, `divide`, and `abs` for performing complex-number operations, and override `toString` method for returning a string representation for a complex number. The `toString` method returns $(a + bi)$ as a string. If `b` is `0`, it simply returns `a`.

Provide three constructors `Complex(a, b)`, `Complex(a)`, and `Complex()`. `Complex()` creates a `Complex` object for number `0` and `Complex(a)` creates a `Complex` object with `0` for `b`. Also provide the `getRealPart()` and `getImaginaryPart()` methods for returning the real and imaginary part of the complex number, respectively.

Write a test program that prompts the user to enter two complex numbers and displays the result of their addition, subtraction, multiplication, and division. Here is a sample run:

```
Enter the first complex number: 3.5 5.5 
Enter the second complex number: -3.5 1 
(3.5 + 5.5i) + (-3.5 + 1.0i) = 0.0 + 6.5i
(3.5 + 5.5i) - (-3.5 + 1.0i) = 7.0 + 4.5i
(3.5 + 5.5i) * (-3.5 + 1.0i) = -17.75 + -15.75i
(3.5 + 5.5i) / (-3.5 + 1.0i) = -0.5094 + -1.7i
|(3.5 + 5.5i)| = 6.519202405202649
```



****15.20** (*Mandelbrot fractal*) Mandelbrot fractal is a well-known image created from a Mandelbrot set (see Figure 15.13a). A Mandelbrot set is defined using the following iteration:

$$z_{n+1} = z_n^2 + c$$

c is a complex number and the starting point of iteration is $z_0 = 0$. For a given c , the iteration will produce a sequence of complex numbers: $\{z_0, z_1, \dots, z_n, \dots\}$. It can be shown that the sequence either tends to infinity or stays bounded, depending on the value of c . For example, if c is `0`, the sequence is $\{0, 0, \dots\}$, which is bounded. If c is i , the sequence is $\{0, i, -1 + i, -i, -1 + i, i, \dots\}$, which is bounded. If c is $1 + i$, the sequence is $\{0, 1 + i, 1 + 3i, \dots\}$, which is unbounded. It is known that if the absolute value of a complex value z_i in the sequence is greater than 2, then the sequence is unbounded. The Mandelbrot set consists of the c value such that the sequence is bounded. For example, `0` and i are in the Mandelbrot set. A Mandelbrot image can be created using the following code:

```
1 class MandelbrotCanvas extends JPanel {
2     final static int COUNT_LIMIT = 60;
```

```

3
4  @Override /** Paint a Mandelbrot image */
5  protected void paintComponent(Graphics g) {
6      super.paintComponent(g);
7
8      for (double x = -2.0; x < 2.0; x += 0.01)
9          for (double y = -2.0; y < 2.0; y += 0.01) {
10             int c = count(new Complex(x, y));
11             if (c == COUNT_LIMIT)
12                 g.setColor(Color.BLACK); // c is in a Mandelbrot set
13             else
14                 g.setColor(new Color(
15                     c * 77 % 256, c * 58 % 256, c * 159 % 256));
16
17             g.drawRect((int)(x * 100) + 200, (int)(y * 100) + 200,
18                 1, 1); // Fill a tiny rectangle with the specified color
19         }
20     }
21
22     /** Return the iteration count */
23     static int count(Complex c) {
24         Complex z = new Complex(0, 0); // z0
25
26         for (int i = 0; i < COUNT_LIMIT; i++) {
27             z = z.multiply(z).add(c); // Get z1, z2, . . .
28             if (z.abs() > 2) return i; // The sequence is unbounded
29         }
30
31         return COUNT_LIMIT; // Indicate a bounded sequence
32     }
33 }

```

The `count(Complex c)` method (lines 23–32) computes z_1, z_2, \dots, z_{60} . If none of their absolute values exceeds 2, we assume c is in the Mandelbrot set. Of course, there could always be an error, but 60 (`COUNT_LIMIT`) iterations usually are enough. Once we find that the sequence is unbounded, the method returns the

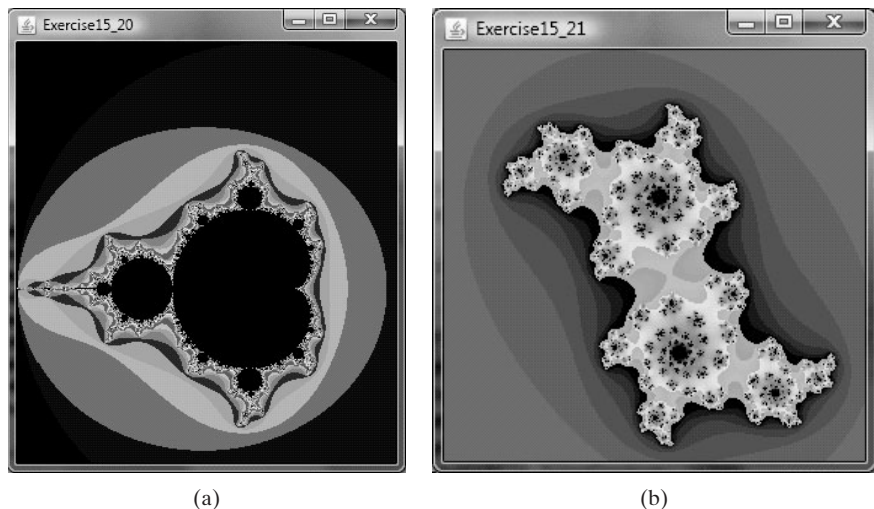


FIGURE 15.13 A Mandelbrot image is shown in (a) and a Julia set image is shown in (b).

iteration count (line 28). The method returns `COUNT_LIMIT` if the sequence is bounded (line 31).

The loop in lines 8–9 examines each point (x, y) for $-2 < x < 2$ and $-2 < y < 2$ with interval 0.01 to see if its corresponding complex number $c = x + yi$ is in the Mandelbrot set (line 10). If so, paint the point black (line 12). If not, set a color that is dependent on its iteration count (line 15). Note that the point is painted in a square with width u and height 1 . All the points are scaled and mapped to a grid of 400-by-400 pixels (lines 14–15). Note that the values `77`, `58`, and `159` are set arbitrarily. You may set different numbers to get new colors.

Complete the program to draw a Mandelbrot image, as shown in Figure 15.13a.

****15.21** (*Julia set*) The preceding exercise describes Mandelbrot sets. The Mandelbrot set consists of the complex c value such that the sequence $z_{n+1} = z_n^2 + c$ is bounded with z_0 fixed and c varying. If we fix c and vary $z_0 (= x + yi)$, the point (x, y) is said to be in a Julia set for a fixed complex value c , if the function $z_{n+1} = z_n^2 + c$ stays bounded. Revise Exercise 15.20 to draw a Julia set as shown in Figure 15.13b. Note that you only need to revise the `count` method by using a fixed c value ($-0.3 + 0.6i$).

15.22 (*Use the `Rational` class*) Write a program that computes the following summation series using the `Rational` class:

$$\frac{1}{2} + \frac{2}{3} + \frac{3}{4} + \dots + \frac{98}{99} + \frac{99}{100}$$

You will discover that the output is incorrect because of integer overflow (too large). To fix this problem, see Programming Exercise 15.17.

This page intentionally left blank

EVENT-DRIVEN PROGRAMMING

Objectives

- To get a taste of event-driven programming (§16.1).
- To describe events, event sources, and event classes (§16.2).
- To define listener classes, register listener objects with the source object, and write the code to handle events (§16.3).
- To define listener classes using inner classes (§16.4).
- To define listener classes using anonymous inner classes (§16.5).
- To explore various coding styles for creating and registering listener classes (§16.6).
- To develop a GUI application for a loan calculator (§16.7).
- To write programs to deal with `MouseEvent`s (§16.8).
- To simplify coding for listener classes using listener interface adapters (§16.9).
- To write programs to deal with `KeyEvent`s (§16.10).
- To use the `javax.swing.Timer` class to control animations (§16.11).



16.1 Introduction



You can write code to process events such as a button click or a timer.

problem

Suppose you want to write a GUI program that lets the user enter a loan amount, annual interest rate, and number of years and click the *Compute Payment* button to obtain the monthly payment and total payment, as shown in Figure 16.1a. How do you accomplish the task? You have to use *event-driven programming* to write the code to respond to the button-clicking event.



FIGURE 16.1 (a) The program computes loan payments. (b)–(d) A flag is rising upward.

Suppose you want to write a program that animates a rising flag, as shown in Figure 16.1b–d. How do you accomplish the task? There are several ways to program this. An effective one is to use a timer in event-driven programming, which is the subject of this chapter.

problem

Before delving into event-driven programming, it is helpful to get a taste using a simple example. The example displays two buttons in a frame, as shown in Figure 16.2.

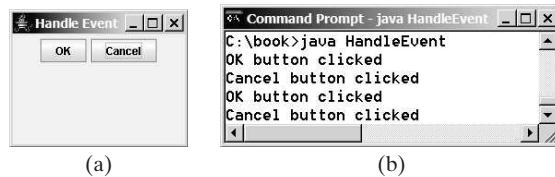


FIGURE 16.2 (a) The program displays two buttons. (b) A message is displayed in the console when a button is clicked.

To respond to a button click, you need to write the code to process the button-clicking action. The button is an *event source object*—where the action originates. You need to create an object capable of handling the action event on a button. This object is called an *event listener*, as shown in Figure 16.3.

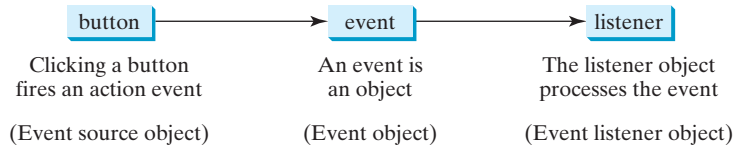


FIGURE 16.3 A listener object processes the event fired from the source object.

Not all objects can be listeners for an action event. To be a listener of an action event, two requirements must be met:

ActionListener interface

addActionListener(listener)

1. The object must be an instance of the **ActionListener** interface. This interface defines the common behavior for all action listeners.
2. The **ActionListener** object **listener** must be registered with the event source object using the method **source.addActionListener(listener)**.

The `ActionListener` interface contains the `actionPerformed` method for processing the event. Your listener class must override this method to respond to the event. Listing 16.1 gives the code that processes the `ActionEvent` on the two buttons. When you click the *OK* button, the message “OK button clicked” is displayed. When you click the *Cancel* button, the message “Cancel button clicked” is displayed, as shown in Figure 16.2.

LISTING 16.1 HandleEvent.java

```

1  import javax.swing.*;
2  import java.awt.event.*;
3
4  public class HandleEvent extends JFrame {
5      public HandleEvent() {
6          // Create two buttons
7          JButton jbtOK = new JButton("OK");
8          JButton jbtCancel = new JButton("Cancel");
9
10         // Create a panel to hold buttons
11         JPanel panel = new JPanel();
12         panel.add(jbtOK);
13         panel.add(jbtCancel);
14
15         add(panel); // Add panel to the frame
16
17         // Register listeners
18         OKListenerClass listener1 = new OKListenerClass();           create listener
19         CancelListenerClass listener2 = new CancelListenerClass();
20         jbtOK.addActionListener(listener1);                          register listener
21         jbtCancel.addActionListener(listener2);
22     }
23
24     public static void main(String[] args) {
25         JFrame frame = new HandleEvent();
26         frame.setTitle("Handle Event");
27         frame.setSize(200, 150);
28         frame.setLocation(200, 100);
29         frame.setDefaultCloseOperation(JFrame.EXIT_ON_CLOSE);
30         frame.setVisible(true);
31     }
32 }
33
34 class OKListenerClass implements ActionListener {                     listener class
35     @Override
36     public void actionPerformed(ActionEvent e) {                     process event
37         System.out.println("OK button clicked");
38     }
39 }
40
41 class CancelListenerClass implements ActionListener {                 listener class
42     @Override
43     public void actionPerformed(ActionEvent e) {                     process event
44         System.out.println("Cancel button clicked");
45     }
46 }

```

Two listener classes are defined in lines 34–46. Each listener class implements `ActionListener` to process `ActionEvent`. The object `listener1` is an instance of `OKListenerClass` (line 18), which is registered with the button `jbtOK` (line 20). When the *OK* button is clicked, the `actionPerformed(ActionEvent)` method (line 36) in

OKListenerClass is invoked to process the event. The object **Listener2** is an instance of **CancelListenerClass** (line 19), which is registered with the button **jbtCancel** in line 21. When the *Cancel* button is clicked, the **actionPerformed(ActionEvent)** method (line 43) in **CancelListenerClass** is invoked to process the event.

You now have seen a glimpse of event-driven programming in Java. You probably have many questions, such as why a listener class is defined to implement the **ActionListener**. The following sections will give you all the answers.

16.2 Events and Event Sources



An event is an object created from an event source. Firing an event means to create an event and delegate the listener to handle the event.

When you run a Java GUI program, the program interacts with the user, and the events drive its execution. This is called *event-driven programming*. An *event* can be defined as a signal to the program that something has happened. Events are triggered either by external user actions, such as mouse movements, button clicks, and keystrokes, or by internal program activities, such as a timer. The program can choose to respond to or ignore an event. The example in the preceding section gave you a taste of event-driven programming.

The component that creates an event and fires it is called the *event source object*, or simply *source object* or *source component*. For example, a button is the source object for a button-clicking action event. An event is an instance of an event class. The root class of the event classes is **java.util.EventObject**. The hierarchical relationships of some event classes are shown in Figure 16.4.

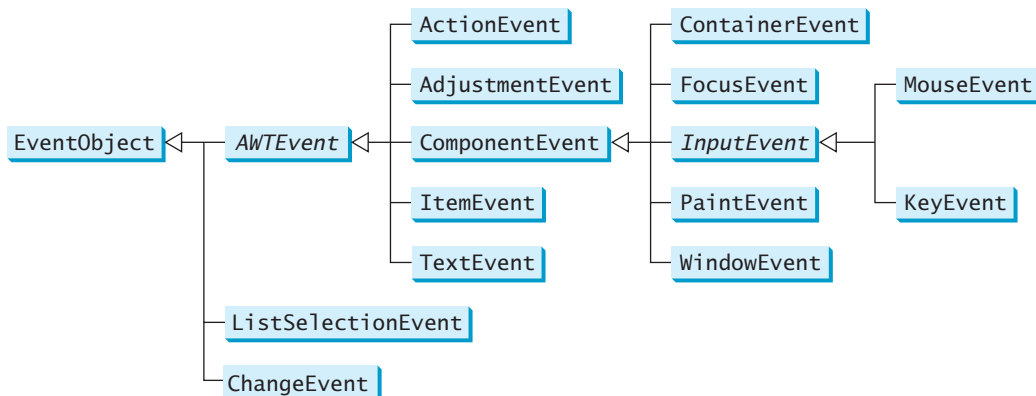


FIGURE 16.4 An event is an object of the **EventObject** class.

event object
getSource()

An *event object* contains whatever properties are pertinent to the event. You can identify the source object of an event using the **getSource()** instance method in the **EventObject** class. The subclasses of **EventObject** deal with specific types of events, such as action events, window events, component events, mouse events, and key events. The first three columns in Table 16.1 list some external user actions, source objects, and event types fired. For example, when clicking a button, the button creates and fires an **ActionEvent**, as indicated in the first line of this table. Here the button is an event source object and an **ActionEvent** is the event object fired by the source object, as shown in Figure 16.2.



Note

If a component can fire an event, any subclass of the component can fire the same type of event. For example, every GUI component can fire **MouseEvent** and **KeyEvent**, since **Component** is the superclass of all GUI components.

TABLE 16.1 User Action, Source Object, Event Type, Listener Interface, and Handler

<i>User Action</i>	<i>Source Object</i>	<i>Event Type Fired</i>	<i>Listener Interface</i>	<i>Listener Interface Methods</i>
Click a button	JButton	ActionEvent	ActionListener	actionPerformed(ActionEvent e)
Press Enter in a text field	JTextField	ActionEvent	ActionListener	actionPerformed(ActionEvent e)
Select a new item	JComboBox	ActionEvent ItemEvent	ActionListener ItemListener	actionPerformed(ActionEvent e) itemStateChanged(ItemEvent e)
Check or uncheck	JRadioButton	ActionEvent ItemEvent	ActionListener ItemListener	actionPerformed(ActionEvent e) itemStateChanged(ItemEvent e)
Check or uncheck	JCheckBox	ActionEvent ItemEvent	ActionListener ItemListener	actionPerformed(ActionEvent e) itemStateChanged(ItemEvent e)
Select a new item	JComboBox	ActionEvent ItemEvent	ActionListener ItemListener	actionPerformed(ActionEvent e) itemStateChanged(ItemEvent e)
Mouse pressed	Component	MouseEvent	MouseListener	mousePressed(MouseEvent e)
Mouse released				mouseReleased(MouseEvent e)
Mouse clicked				mouseClicked(MouseEvent e)
Mouse entered				mouseEntered(MouseEvent e)
Mouse exited				mouseExited(MouseEvent e)
Mouse moved			MouseMotionListener	mouseMoved(MouseEvent e)
Mouse dragged				mouseDragged(MouseEvent e)
Key pressed	Component	KeyEvent	KeyListener	keyPressed(KeyEvent e)
Key released				keyReleased(KeyEvent e)
Key typed				keyTyped(KeyEvent e)

**Note**

All the event classes in Figure 16.4 are included in the `java.awt.event` package except `ListSelectionEvent` and `ChangeEvent`, which are in the `javax.swing.event` package. AWT events were originally designed for AWT components, but many Swing components fire them.

16.1 What is an event source object? What is an event object? Describe the relationship between an event source object and an event object.



16.2 Can a button fire a `MouseEvent`? Can a button fire a `KeyEvent`? Can a button fire an `ActionEvent`?

MyProgrammingLab™

16.3 Listeners, Registrations, and Handling Events

A listener is an object that must be registered with an event source object, and it must be an instance of an appropriate event-handling interface.



Java uses a delegation-based model for event handling: a source object fires an event, and an object interested in the event handles it. The latter object is called an *event listener* or simply *listener*. For an object to be a listener for an event on a source object, two things are needed, as shown in Figure 16.5.

event delegation
event listener

1. *The listener object must be an instance of the corresponding event-listener interface to ensure that the listener has the correct method for processing the event. Java provides a listener interface for every type of event. The listener interface is usually named `XListener` for `XEvent`, with the exception of `MouseMotionListener`. The last*

event-listener interface

XListener/XEvent

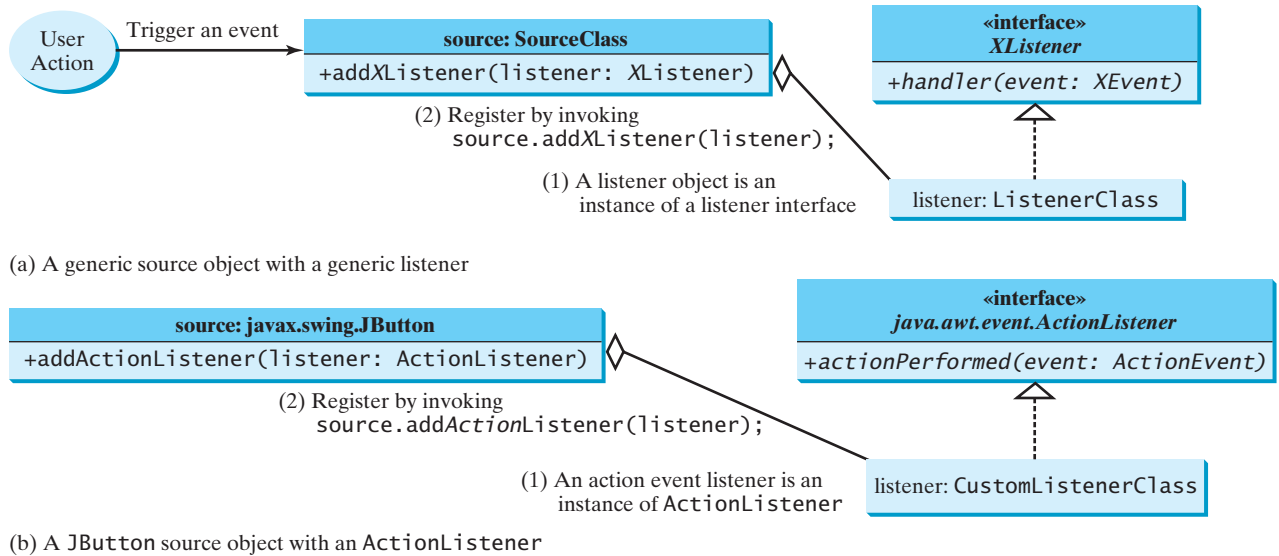


FIGURE 16.5 A listener must be an instance of a listener interface and must be registered with a source object.

three columns in Table 16.1 list event types, the corresponding listener interfaces, and the methods defined in the listener interfaces. The listener interface contains the method(s), known as the *event handler(s)*, for processing the event. For example, as shown in the first line of this table, the corresponding listener interface for **ActionEvent** is **ActionListener**; each listener for **ActionEvent** should implement the **ActionListener** interface; the **ActionListener** interface contains the handler **actionPerformed(ActionEvent)** for processing an **ActionEvent**.

event handler

register listener

2. The listener object must be registered by the source object. Registration methods depend on the event type. For **ActionEvent**, the method is **addActionListener**. In general, the method is named **addXListener** for **XEvent**. A source object may fire several types of events, and for each event the source object maintains a list of registered listeners and notifies them by invoking the *handler* of the listener object to respond to the event, as shown in Figure 16.6. (Note that this figure shows the internal implementation of a source class. You don't have to know how a source class such as **JButton** is implemented in order to use it, but this knowledge will help you understand the Java event-driven programming framework.)

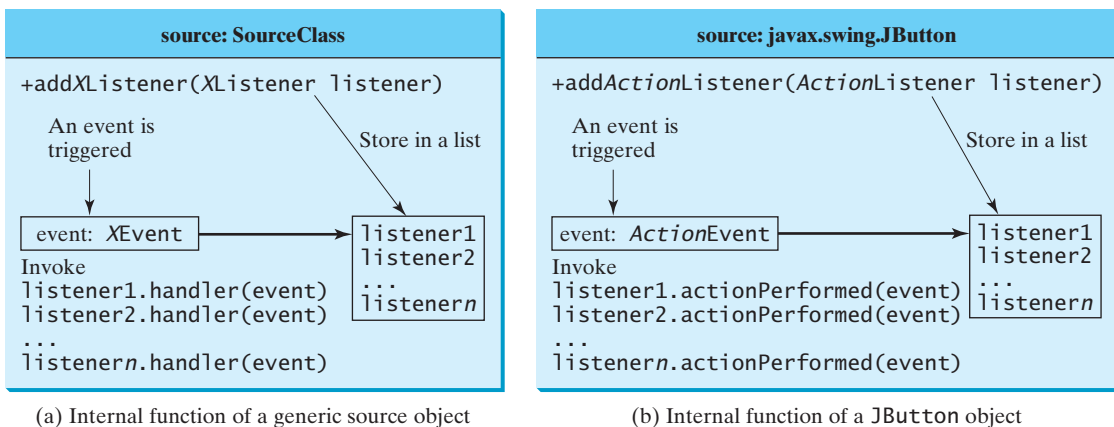


FIGURE 16.6 The source object notifies the listeners of the event by invoking the listener object's handler.

Let's revisit Listing 16.1, `HandleEvent.java`. Since a `JButton` object fires `ActionEvent`, a listener object for `ActionEvent` must be an instance of `ActionListener`, so the listener class implements `ActionListener` in line 34. The source object invokes `addActionListener(listener)` to register a listener, as follows:

```
JButton jbtOK = new JButton("OK"); // Line 7 in Listing 16.1           create source object

OKListenerClass listener1
    = new OKListenerClass(); // Line 18 in Listing 16.1             create listener object

jbtOK.addActionListener(listener1); // Line 20 in Listing 16.1     register listener
```

When you click the button, the `JButton` object fires an `ActionEvent` and passes it to invoke the listener's `actionPerformed` method to handle the event.

The event object contains information pertinent to the event, which can be obtained using the methods, as shown in Figure 16.7. For example, you can use `e.getSource()` to obtain the source object that fired the event. For an action event, you can use `e.getWhen()` to obtain the time when the event occurred.

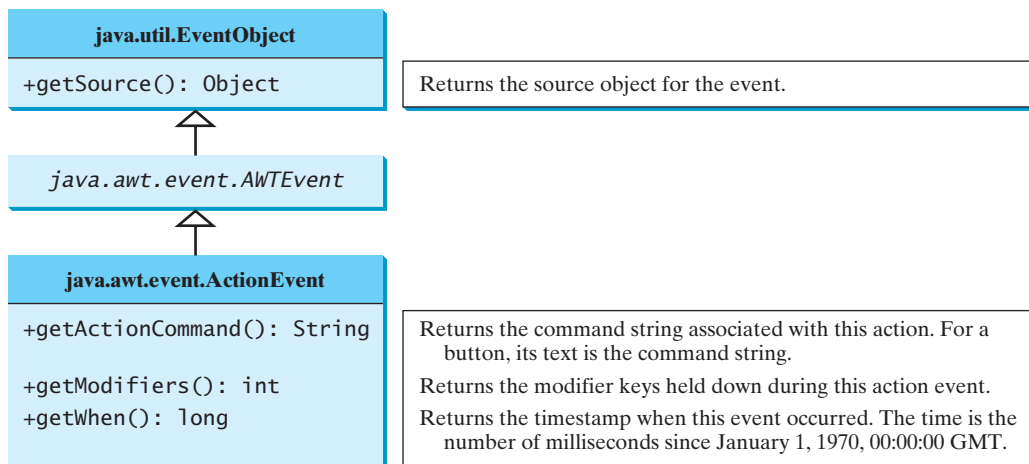


FIGURE 16.7 You can obtain useful information from an event object.

We now write a program that uses two buttons to control the size of a circle, as shown in Figure 16.8.



FIGURE 16.8 The user clicks the *Enlarge* and *Shrink* buttons to enlarge and shrink the size of the circle.

We will develop this program incrementally. First we will write the program in Listing 16.2 that displays the user interface with a circle in the center (line 14) and two buttons on the bottom (line 15). first version

LISTING 16.2 ControlCircleWithoutEventHandling.java

```

1  import javax.swing.*;
2  import java.awt.*;
3
4  public class ControlCircleWithoutEventHandling extends JFrame {
5      private JButton jbtEnlarge = new JButton("Enlarge");
6      private JButton jbtShrink = new JButton("Shrink");
7      private CirclePanel canvas = new CirclePanel();
8
9      public ControlCircleWithoutEventHandling() {
10         JPanel panel = new JPanel(); // Use the panel to group buttons
11         panel.add(jbtEnlarge);
12         panel.add(jbtShrink);
13
14         this.add(canvas, BorderLayout.CENTER); // Add canvas to center
15         this.add(panel, BorderLayout.SOUTH); // Add buttons to the frame
16     }
17
18     /** Main method */
19     public static void main(String[] args) {
20         JFrame frame = new ControlCircleWithoutEventHandling();
21         frame.setTitle("ControlCircleWithoutEventHandling");
22         frame.setLocationRelativeTo(null); // Center the frame
23         frame.setDefaultCloseOperation(JFrame.EXIT_ON_CLOSE);
24         frame.setSize(200, 200);
25         frame.setVisible(true);
26     }
27 }
28
29 class CirclePanel extends JPanel {
30     private int radius = 5; // Default circle radius
31
32     @Override /** Repaint the circle */
33     protected void paintComponent(Graphics g) {
34         super.paintComponent(g);
35         g.drawOval(getWidth() / 2 - radius, getHeight() / 2 - radius,
36                 2 * radius, 2 * radius);
37     }
38 }

```

buttons

circle canvas

CirclePanel class

paint the circle

How do you use the buttons to enlarge or shrink the circle? When the *Enlarge* button is clicked, you want the circle to be repainted with a larger radius. How can you accomplish this? You can expand the program in Listing 16.2 into Listing 16.3 with the following features:

second version

1. Define a listener class named **EnlargeListener** that implements **ActionListener** (lines 31–36).
2. Create a listener and register it with **jbtEnlarge** (line 18).
3. Add a method named **enlarge()** in **CirclePanel** to increase the radius, then repaint the panel (lines 42–45).
4. Implement the **actionPerformed** method in **EnlargeListener** to invoke **canvas.enlarge()** (line 34).
5. To make the reference variable **canvas** accessible from the **actionPerformed** method, define **EnlargeListener** as an inner class of the **ControlCircle** class (lines 31–36). (*Inner classes* are defined inside another class. We will introduce inner classes in the next section.)

inner class

6. To avoid compile errors, the `CirclePanel` class (lines 38–53) now is also defined as an inner class in `ControlCircle`, since another `CirclePanel` class is already defined in Listing 16.2.

LISTING 16.3 ControlCircle.java

```

1  import javax.swing.*;
2  import java.awt.*;
3  import java.awt.event.*;
4
5  public class ControlCircle extends JFrame {
6      private JButton jbtEnlarge = new JButton("Enlarge");
7      private JButton jbtShrink = new JButton("Shrink");
8      private CirclePanel canvas = new CirclePanel();
9
10     public ControlCircle() {
11         JPanel panel = new JPanel(); // Use the panel to group buttons
12         panel.add(jbtEnlarge);
13         panel.add(jbtShrink);
14
15         this.add(canvas, BorderLayout.CENTER); // Add canvas to center
16         this.add(panel, BorderLayout.SOUTH); // Add buttons to the frame
17
18         jbtEnlarge.addActionListener(new EnlargeListener());
19     }
20
21     /** Main method */
22     public static void main(String[] args) {
23         JFrame frame = new ControlCircle();
24         frame.setTitle("ControlCircle");
25         frame.setLocationRelativeTo(null); // Center the frame
26         frame.setDefaultCloseOperation(JFrame.EXIT_ON_CLOSE);
27         frame.setSize(200, 200);
28         frame.setVisible(true);
29     }
30
31     class EnlargeListener implements ActionListener { // Inner class
32         @Override
33         public void actionPerformed(ActionEvent e) {
34             canvas.enlarge();
35         }
36     }
37
38     class CirclePanel extends JPanel { // Inner class
39         private int radius = 5; // Default circle radius
40
41         /** Enlarge the circle */
42         public void enlarge() {
43             radius++;
44             repaint();
45         }
46
47         @Override
48         protected void paintComponent(Graphics g) {
49             super.paintComponent(g);
50             g.drawOval(getWidth() / 2 - radius, getHeight() / 2 - radius,
51                 2 * radius, 2 * radius);
52         }
53     }
54 }

```



VideoNote

Listener and its registration

create/register listener

listener class

CirclePanel class

enlarge method

the *Shrink* button

Similarly, you can add the code for the *Shrink* button to display a smaller circle when the *Shrink* button is clicked.



MyProgrammingLab™

- 16.3** Why must a listener be an instance of an appropriate listener interface? Explain how to register a listener object and how to implement a listener interface.
- 16.4** Can a source have multiple listeners? Can a listener listen to multiple sources? Can a source be a listener for itself?
- 16.5** How do you implement a method defined in the listener interface? Do you need to implement all the methods defined in the listener interface?
- 16.6** What method do you use to get the timestamp for an action event?

16.4 Inner Classes



An inner class, or nested class, is a class defined within the scope of another class. Inner classes are useful for defining listener classes.

We now introduce inner classes in this section and anonymous inner classes in the next section and use them to define listener classes. First let us see the code in Figure 16.9. The code in Figure 16.9a defines two separate classes, **Test** and **A**. The code in Figure 16.9b defines **A** as an inner class in **Test**.

```
public class Test {
    ...
}

public class A {
    ...
}
```

(a)

```
public class Test {
    ...

    // Inner class
    public class A {
        ...
    }
}
```

(b)

```
// OuterClass.java: inner class demo
public class OuterClass {
    private int data;

    /** A method in the outer class */
    public void m() {
        // Do something
    }

    // An inner class
    class InnerClass {
        /** A method in the inner class */
        public void mi() {
            // Directly reference data and method
            // defined in its outer class
            data++;
            m();
        }
    }
}
```

(c)

FIGURE 16.9 Inner classes combine dependent classes into the primary class.

The class **InnerClass** defined inside **OuterClass** in Figure 16.9c is another example of an inner class. An inner class may be used just like a regular class. Normally, you define a class as an inner class if it is used only by its outer class. An inner class has the following features:

- An inner class is compiled into a class named **OuterClassName\$InnerClassName.class**. For example, the inner class **A** in **Test** is compiled into **Test\$A.class** in Figure 16.9b.
- An inner class can reference the data and methods defined in the outer class in which it nests, so you need not pass the reference of an object of the outer class to the constructor of the inner class. For this reason, inner classes can make programs simple and concise.

For example, `canvas` is defined in `ControlCircle` in Listing 16.3 (line 8). It can be referenced in the inner class `EnlargeListener` in line 34.

- An inner class can be defined with a visibility modifier subject to the same visibility rules applied to a member of the class.
- An inner class can be defined as `static`. A `static` inner class can be accessed using the outer class name. A `static` inner class cannot access nonstatic members of the outer class.
- Objects of an inner class are often created in the outer class. But you can also create an object of an inner class from another class. If the inner class is nonstatic, you must first create an instance of the outer class, then use the following syntax to create an object for the inner class:

```
OuterClass.InnerClass innerObject = outerObject.new InnerClass();
```

- If the inner class is static, use the following syntax to create an object for it:

```
OuterClass.InnerClass innerObject = new OuterClass.InnerClass();
```

A simple use of inner classes is to combine dependent classes into a primary class. This reduces the number of source files. It also makes class files easy to organize, since they are all named with the primary class as the prefix. For example, rather than creating the two source files `Test.java` and `A.java` in Figure 16.9a, you can merge class `A` into class `Test` and create just one source file, `Test.java` in Figure 16.9b. The resulting class files are `Test.class` and `Test$A.class`.

Another practical use of inner classes is to avoid class-naming conflicts. Two versions of `CirclePanel` are defined in Listings 16.2 and 16.3. You can define them as inner classes to avoid a conflict.

A listener class is designed specifically to create a listener object for a GUI component (e.g., a button). The listener class will not be shared by other applications and therefore is appropriate to be defined inside the frame class as an inner class.

16.7 Can an inner class be used in a class other than the class in which it nests?

16.8 Can the modifiers `public`, `private`, and `static` be used for inner classes?



MyProgrammingLab™

16.5 Anonymous Class Listeners

An anonymous inner class is an inner class without a name. It combines defining an inner class and creating an instance of the class into one step.



Inner-class listeners can be shortened using *anonymous inner classes*. The inner class in Listing 16.3 can be replaced by an anonymous inner class as shown below.

```
public ControlCircle() {
    // Omitted

    jbtEnlarge.addActionListener(
        new EnlargeListener());
}

class EnlargeListener
    implements ActionListener {
    @Override
    public void actionPerformed(ActionEvent e) {
        canvas.enlarge();
    }
}
```

(a) Inner class `EnlargeListener`

```
public ControlCircle() {
    // Omitted

    jbtEnlarge.addActionListener(
        new class EnlargeListener
            implements ActionListener() {
            @Override
            public void actionPerformed(ActionEvent e) {
                canvas.enlarge();
            }
        });
}
```

(b) Anonymous inner class

The syntax for an anonymous inner class is:

```
new SuperClassName/InterfaceName() {
    // Implement or override methods in superclass or interface

    // Other methods if necessary
}
```

Since an anonymous inner class is a special kind of inner class, it is treated like an inner class with the following features:

- An anonymous inner class must always extend a superclass or implement an interface, but it cannot have an explicit **extends** or **implements** clause.
- An anonymous inner class must implement all the abstract methods in the superclass or in the interface.
- An anonymous inner class always uses the no-arg constructor from its superclass to create an instance. If an anonymous inner class implements an interface, the constructor is **Object()**.
- An anonymous inner class is compiled into a class named **OuterClassName\$n.class**. For example, if the outer class **Test** has two anonymous inner classes, they are compiled into **Test\$1.class** and **Test\$2.class**.

Listing 16.4 gives an example that handles the events from four buttons, as shown in Figure 16.10.



FIGURE 16.10 The program handles the events from four buttons.



VideoNote
Anonymous listener

LISTING 16.4 AnonymousListenerDemo.java

```
1 import javax.swing.*;
2 import java.awt.event.*;
3
4 public class AnonymousListenerDemo extends JFrame {
5     public AnonymousListenerDemo() {
6         // Create four buttons
7         JButton jbtNew = new JButton("New");
8         JButton jbtOpen = new JButton("Open");
9         JButton jbtSave = new JButton("Save");
10        JButton jbtPrint = new JButton("Print");
11
12        // Create a panel to hold buttons
13        JPanel panel = new JPanel();
14        panel.add(jbtNew);
15        panel.add(jbtOpen);
16        panel.add(jbtSave);
17        panel.add(jbtPrint);
18
19        add(panel);
```

```

20
21 // Create and register anonymous inner-class listener
22 jbtNew.addActionListener(new ActionListener() {
23     @Override
24     public void actionPerformed(ActionEvent e) {
25         System.out.println("Process New");
26     }
27 }
28 );
29
30 jbtOpen.addActionListener(new ActionListener() {
31     @Override
32     public void actionPerformed(ActionEvent e) {
33         System.out.println("Process Open");
34     }
35 }
36 );
37
38 jbtSave.addActionListener(new ActionListener() {
39     @Override
40     public void actionPerformed(ActionEvent e) {
41         System.out.println("Process Save");
42     }
43 }
44 );
45
46 jbtPrint.addActionListener(new ActionListener() {
47     @Override
48     public void actionPerformed(ActionEvent e) {
49         System.out.println("Process Print");
50     }
51 }
52 );
53 }
54
55 /** Main method */
56 public static void main(String[] args) {
57     JFrame frame = new AnonymousListenerDemo();
58     frame.setTitle("AnonymousListenerDemo");
59     frame.setLocationRelativeTo(null); // Center the frame
60     frame.setDefaultCloseOperation(JFrame.EXIT_ON_CLOSE);
61     frame.pack();
62     frame.setVisible(true);
63 }
64 }

```

anonymous listener
handle event

The program creates four listeners using anonymous inner classes (lines 22–52). Without using anonymous inner classes, you would have to create four separate classes. An anonymous listener works the same way as an inner class listener. The program is condensed using an anonymous inner class.

Anonymous inner classes are compiled into `OuterClassName$#.class`, where `#` starts at `1` and is incremented for each anonymous class the compiler encounters. In this example, the anonymous inner classes are compiled into `AnonymousListenerDemo$1.class`, `AnonymousListenerDemo$2.class`, `AnonymousListenerDemo$3.class`, and `AnonymousListenerDemo$4.class`.

Instead of using the `setSize` method to set the size for the frame, the program uses the `pack()` method (line 61), which automatically sizes the frame according to the size of the components placed in it. `pack()`



16.9 If class **A** is an inner class in class **B**, what is the .class file for **A**? If class **B** contains two anonymous inner classes, what are the .class file names for these two classes?

MyProgrammingLab™

16.10 What is wrong in the following code?

```
import java.swing.*;
import java.awt.*;

public class Test extends JFrame {
    public Test() {
        JButton jbtOK = new JButton("OK");
        add(jbtOK);
    }

    private class Listener
        implements ActionListener {
        public void actionPerformed
            (ActionEvent e) {
            System.out.println
                (jbtOK.getActionCommand());
        }
    }

    /** Main method omitted */
}
```

(a)

```
import java.awt.event.*;
import javax.swing.*;

public class Test extends JFrame {
    public Test() {
        JButton jbtOK = new JButton("OK");
        add(jbtOK);
        jbtOK.addActionListener(
            new ActionListener() {
                public void actionPerformed
                    (ActionEvent e) {
                    System.out.println
                        (jbtOK.getActionCommand());
                }
            } // Something missing here
        );

    /** Main method omitted */
}
```

(b)

16.11 What is the difference between the `setSize(width, height)` method and the `pack()` method in `JFrame`?

16.6 Alternative Ways of Defining Listener Classes



Using an inner class or an anonymous inner class is preferred for defining listener classes.

There are many other ways to define the listener classes. For example, you can rewrite Listing 16.4 by creating just one listener, register the listener with the buttons, and let the listener detect the event source—that is, which button fires the event—as shown in Listing 16.5.

LISTING 16.5 DetectSourceDemo.java

```
1 import javax.swing.*;
2 import java.awt.event.*;
3
4 public class DetectSourceDemo extends JFrame {
5     // Create four buttons
6     private JButton jbtNew = new JButton("New");
7     private JButton jbtOpen = new JButton("Open");
8     private JButton jbtSave = new JButton("Save");
9     private JButton jbtPrint = new JButton("Print");
10
11     public DetectSourceDemo() {
12         // Create a panel to hold buttons
13         JPanel panel = new JPanel();
14         panel.add(jbtNew);
15         panel.add(jbtOpen);
16         panel.add(jbtSave);
17         panel.add(jbtPrint);
18 }
```



```

19     add(panel);
20
21     // Create a listener
22     ButtonListener listener = new ButtonListener();           create listener
23
24     // Register listener with buttons
25     jbtNew.addActionListener(listener);                       register listener
26     jbtOpen.addActionListener(listener);
27     jbtSave.addActionListener(listener);
28     jbtPrint.addActionListener(listener);
29 }
30
31 class ButtonListener implements ActionListener {               listener class
32     @Override
33     public void actionPerformed(ActionEvent e) {               handle event
34         if (e.getSource() == jbtNew)
35             System.out.println("Process New");
36         else if (e.getSource() == jbtOpen)
37             System.out.println("Process Open");
38         else if (e.getSource() == jbtSave)
39             System.out.println("Process Save");
40         else if (e.getSource() == jbtPrint)
41             System.out.println("Process Print");
42     }
43 }
44
45 /** Main method */
46 public static void main(String[] args) {
47     JFrame frame = new DetectSourceDemo();
48     frame.setTitle("DetectSourceDemo");
49     frame.setLocationRelativeTo(null); // Center the frame
50     frame.setDefaultCloseOperation(JFrame.EXIT_ON_CLOSE);
51     frame.pack();
52     frame.setVisible(true);
53 }
54 }

```

This program defines just one inner listener class (lines 31–43), creates a listener from the class (line 22), and registers it to four buttons (lines 25–28). When a button is clicked, the button fires an `ActionEvent` and invokes the listener’s `actionPerformed` method. The `actionPerformed` method checks the source of the event using the `getSource()` method for the event (lines 34, 36, 38, 40) and determines which button fired the event.

Defining one listener class for handling a large number of events is efficient. In this case, you create just one listener object. Using anonymous inner classes, you would create four listener objects.

You could also rewrite Listing 16.4 by defining the custom frame class that implements `ActionListener`, as shown in Listing 16.6.

LISTING 16.6 FrameAsListenerDemo.java

```

1  import javax.swing.*;
2  import java.awt.event.*;
3
4  public class FrameAsListenerDemo extends JFrame
5      implements ActionListener {                               implement ActionListener
6      // Create four buttons
7      private JButton jbtNew = new JButton("New");
8      private JButton jbtOpen = new JButton("Open");
9      private JButton jbtSave = new JButton("Save");

```

```

10     private JButton jbtPrint = new JButton("Print");
11
12     public FrameAsListenerDemo() {
13         // Create a panel to hold buttons
14         JPanel panel = new JPanel();
15         panel.add(jbtNew);
16         panel.add(jbtOpen);
17         panel.add(jbtSave);
18         panel.add(jbtPrint);
19
20         add(panel);
21
22         // Register listener with buttons
23         jbtNew.addActionListener(this);
24         jbtOpen.addActionListener(this);
25         jbtSave.addActionListener(this);
26         jbtPrint.addActionListener(this);
27     }
28
29     @Override /** Implement actionPerformed */
30     public void actionPerformed(ActionEvent e) {
31         if (e.getSource() == jbtNew)
32             System.out.println("Process New");
33         else if (e.getSource() == jbtOpen)
34             System.out.println("Process Open");
35         else if (e.getSource() == jbtSave)
36             System.out.println("Process Save");
37         else if (e.getSource() == jbtPrint)
38             System.out.println("Process Print");
39     }
40
41     /** Main method */
42     public static void main(String[] args) {
43         JFrame frame = new FrameAsListenerDemo();
44         frame.setTitle("FrameAsListenerDemo");
45         frame.setLocationRelativeTo(null); // Center the frame
46         frame.setDefaultCloseOperation(JFrame.EXIT_ON_CLOSE);
47         frame.pack();
48         frame.setVisible(true);
49     }
50 }

```

register listeners

handle event

The frame class extends `JFrame` and implements `ActionListener` (line 5), so the class is a listener class for action events. The listener is registered to four buttons (lines 23–26). When a button is clicked, the button fires an `ActionEvent` and invokes the listener's `actionPerformed` method. The `actionPerformed` method checks the source of the event using the `getSource()` method for the event (lines 31, 33, 35, 37) and determines which button fired the event.

This design is not desirable, however, because it puts too many responsibilities into one class. It is better to design a listener class that is solely responsible for handling events, which makes the code easy to read and easy to maintain.

You should define listener classes using either inner classes or anonymous inner classes—choose whichever produces shorter, clearer, and cleaner code. In general, use anonymous inner classes if the code in the listener is short and the listener is registered for one event source. Use inner classes if the code in the listener is long or the listener is registered for multiple event sources.

Which way is preferred?



16.12 Why should you avoid defining the custom frame class that implements `ActionListener`?

16.13 What method do you use to get the source object from an event object `e`?

16.7 Case Study: Loan Calculator

This case study uses GUI components and events.



Now we will write the program for the loan-calculator problem presented at the beginning of this chapter. Here are the major steps in the program:

1. Create the user interface, as shown in Figure 16.11.
 - a. Create a panel of a **GridLayout** with **5** rows and **2** columns. Add labels and text fields to the panel. Set the title “Enter loan amount, interest rate, and years” for the panel.
 - b. Create another panel with a **FlowLayout** (**FlowLayout.RIGHT**) and add a button to the panel.
 - c. Add the first panel to the center of the frame and the second panel on the south side of the frame.
2. Process the event.

Create and register the listener for processing the button-clicking action event. The handler obtains the user input on the loan amount, interest rate, and number of years, computes the monthly and total payments, and displays the values in the text fields.

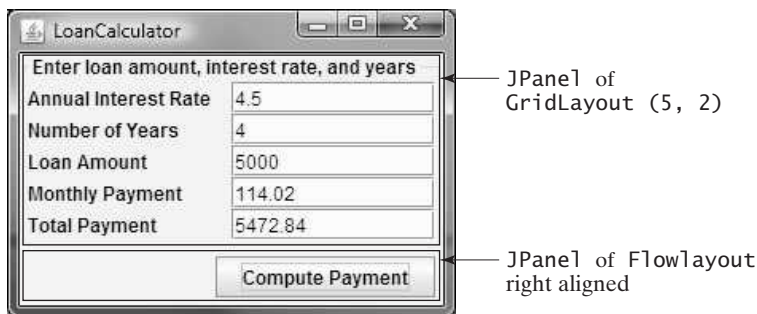


FIGURE 16.11 The program computes loan payments.

The complete program is given in Listing 16.7.

LISTING 16.7 LoanCalculator.java

```

1  import java.awt.*;
2  import java.awt.event.*;
3  import javax.swing.*;
4  import javax.swing.border.TitledBorder;
5
6  public class LoanCalculator extends JFrame {
7      // Create text fields for interest rate, years,
8      // loan amount, monthly payment, and total payment
9      private JTextField jtfAnnualInterestRate = new JTextField();           text fields
10     private JTextField jtfNumberOfYears = new JTextField();
11     private JTextField jtfLoanAmount = new JTextField();
12     private JTextField jtfMonthlyPayment = new JTextField();
13     private JTextField jtfTotalPayment = new JTextField();
14
15     // Create a Compute Payment button
16     private JButton jbtComputeLoan = new JButton("Compute Payment");       button

```

```

17
18 public LoanCalculator() {
19     // Panel p1 to hold labels and text fields
create UI 20     JPanel p1 = new JPanel(new GridLayout(5, 2));
21     p1.add(new JLabel("Annual Interest Rate"));
22     p1.add(jtfAnnualInterestRate);
23     p1.add(new JLabel("Number of Years"));
24     p1.add(jtfNumberOfYears);
25     p1.add(new JLabel("Loan Amount"));
26     p1.add(jtfLoanAmount);
27     p1.add(new JLabel("Monthly Payment"));
28     p1.add(jtfMonthlyPayment);
29     p1.add(new JLabel("Total Payment"));
30     p1.add(jtfTotalPayment);
31     p1.setBorder(new
32         TitledBorder("Enter loan amount, interest rate, and years"));
33
34     // Panel p2 to hold the button
add to frame 35     JPanel p2 = new JPanel(new FlowLayout(FlowLayout.RIGHT));
36     p2.add(jbtComputeLoan);
37
38     // Add the panels to the frame
39     add(p1, BorderLayout.CENTER);
40     add(p2, BorderLayout.SOUTH);
41
42     // Register listener
register listener 43     jbtComputeLoan.addActionListener(new ButtonListener());
44 }
45
46 /** Handle the Compute Payment button */
47 private class ButtonListener implements ActionListener {
48     @Override
49     public void actionPerformed(ActionEvent e) {
50         // Get values from text fields
get input 51         double interest =
52             Double.parseDouble(jtfAnnualInterestRate.getText());
53         int year = Integer.parseInt(jtfNumberOfYears.getText());
54         double loanAmount =
55             Double.parseDouble(jtfLoanAmount.getText());
56
57         // Create a loan object. Loan defined in Listing 10.2
create loan 58         Loan loan = new Loan(interest, year, loanAmount);
59
60         // Display monthly payment and total payment
set result 61         jtfMonthlyPayment.setText(String.format("%.2f",
62             loan.getMonthlyPayment()));
63         jtfTotalPayment.setText(String.format("%.2f",
64             loan.getTotalPayment()));
65     }
66 }
67
68 public static void main(String[] args) {
69     LoanCalculator frame = new LoanCalculator();
70     frame.pack();
71     frame.setTitle("LoanCalculator");
72     frame.setLocationRelativeTo(null); // Center the frame
73     frame.setDefaultCloseOperation(JFrame.EXIT_ON_CLOSE);
74     frame.setVisible(true);
75 }
76 }

```

The user interface is created in the constructor (lines 18–44). The button is the source of the event. A listener is created and registered with the button (line 43).

The `ButtonListener` class (lines 47–66) implements the `actionPerformed` method. When the button is clicked, the `actionPerformed` method is invoked to get the interest rate (line 51), number of years (line 53), and loan amount (line 54). Invoking `jtfAnnualInterestRate.getText()` returns the string text in the `jtfAnnualInterestRate` text field. The `Loan` class is used for computing the loan payments. This class was introduced in Listing 10.2, `Loan.java`. Invoking `loan.getMonthlyPayment()` returns the monthly payment for the loan (line 62). The `String.format` method, introduced in Section 9.2.11, is used to format a number into a desirable format and returns it as a string (lines 61, 63). Invoking the `setText` method on a text field sets a string value in the text field (line 61).

16.8 Mouse Events

A mouse event is fired whenever a mouse button is pressed, released, or clicked, the mouse is moved, or the mouse is dragged onto a component.



The `MouseEvent` object captures the event, such as the number of clicks associated with it, the location (the *x*- and *y*-coordinates) of the mouse, or which button was pressed, as shown in Figure 16.12.

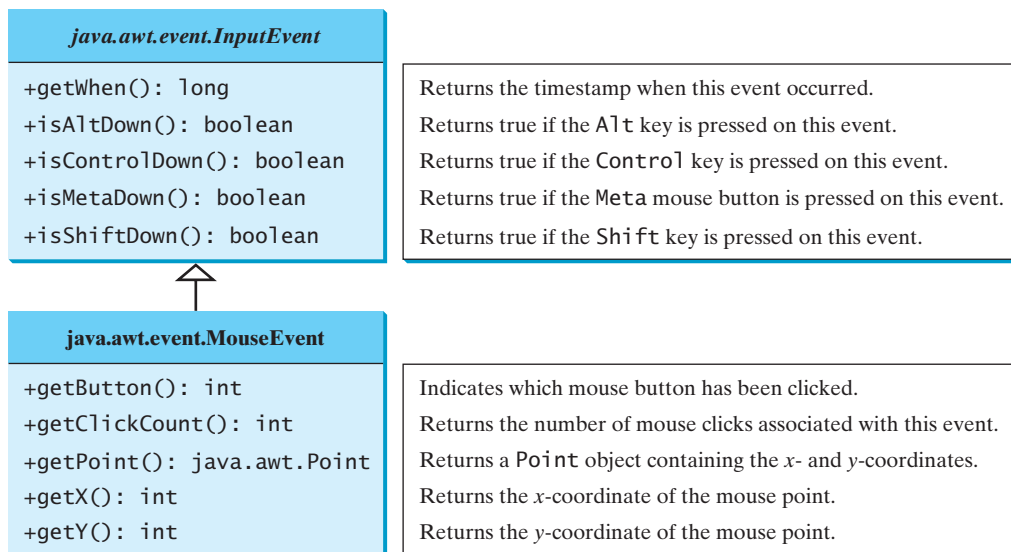


FIGURE 16.12 The `MouseEvent` class encapsulates information for mouse events.

Since the `MouseEvent` class inherits `InputEvent`, you can use the methods defined in the `InputEvent` class on a `MouseEvent` object. For example, the `isControlDown()` method detects whether the `CTRL` key was pressed when a `MouseEvent` is fired.

Three `int` constants—`BUTTON1`, `BUTTON2`, and `BUTTON3`—are defined in `MouseEvent` to indicate the left, middle, and right mouse buttons. You can use the `getButton()` method to detect which button is pressed. For example, `getButton() == MouseEvent.BUTTON3` indicates that the right button was pressed.

detect mouse buttons

The `java.awt.Point` class represents a point on a component. The class contains two public variables, `x` and `y`, for coordinates. To create a `Point`, use the following constructor:

Point class

```
Point(int x, int y)
```

This constructs a **Point** object with the specified *x*- and *y*-coordinates. Normally, the data fields in a class should be private, but this class has two public data fields.

Java provides two listener interfaces, **MouseListener** and **MouseMotionListener**, to handle mouse events, as shown in Figure 16.13. Implement the **MouseListener** interface to listen for such actions as pressing, releasing, entering, exiting, or clicking the mouse, and implement the **MouseMotionListener** interface to listen for such actions as dragging or moving the mouse.

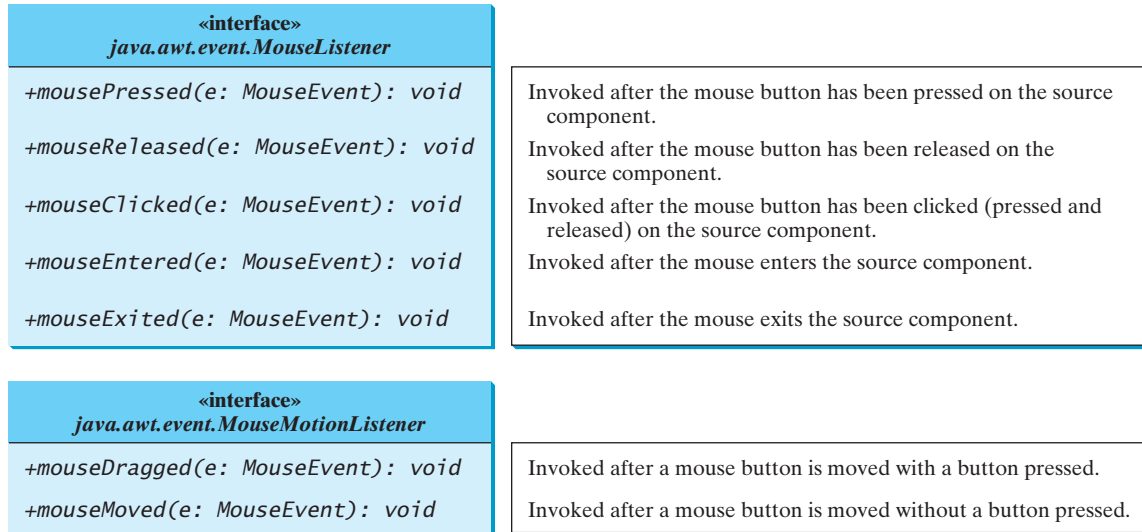


FIGURE 16.13 The **MouseListener** interface handles mouse pressed, released, clicked, entered, and exited events. The **MouseMotionListener** interface handles mouse dragged and moved events.

To demonstrate using mouse events, we give an example that displays a message in a panel and enables the message to be moved using a mouse. The message moves as the mouse is dragged, and it is always displayed at the mouse point. Listing 16.8 gives the program. A sample run of the program is shown in Figure 16.14.



FIGURE 16.14 You can move the message by dragging the mouse.



VideoNote

Move message using the mouse

LISTING 16.8 MoveMessageDemo.java

```

1  import java.awt.*;
2  import java.awt.event.*;
3  import javax.swing.*;
4
5  public class MoveMessageDemo extends JFrame {
6      public MoveMessageDemo() {

```

```

7 // Create a MovableMessagePanel instance for moving a message
8 MovableMessagePanel p = new MovableMessagePanel
9 ("Welcome to Java");
10
11 // Place the message panel in the frame
12 add(p);
13 }
14
15 /** Main method */
16 public static void main(String[] args) {
17     MoveMessageDemo frame = new MoveMessageDemo();
18     frame.setTitle("MoveMessageDemo");
19     frame.setSize(200, 100);
20     frame.setLocationRelativeTo(null); // Center the frame
21     frame.setDefaultCloseOperation(JFrame.EXIT_ON_CLOSE);
22     frame.setVisible(true);
23 }
24
25 // Inner class: MovableMessagePanel draws a message
26 static class MovableMessagePanel extends JPanel {
27     private String message = "Welcome to Java";
28     private int x = 20;
29     private int y = 20;
30
31     /** Construct a panel to draw string s */
32     public MovableMessagePanel(String s) {
33         message = s;
34         addMouseListener(new MouseMotionListener() {
35             @Override /** Handle mouse-dragged event */
36             public void mouseDragged(MouseEvent e) {
37                 // Get the new location and repaint the screen
38                 x = e.getX();
39                 y = e.getY();
40                 repaint();
41             }
42
43             @Override /** Handle mouse-moved event */
44             public void mouseMoved(MouseEvent e) {
45             }
46         });
47     }
48
49     @Override
50     protected void paintComponent(Graphics g) {
51         super.paintComponent(g);
52         g.drawString(message, x, y);
53     }
54 }
55 }

```

create a panel

inner class

set a new message
anonymous listener

override handler

new location

repaint

paint message

The `MovableMessagePanel` class extends `JPanel` to draw a message (line 26). Additionally, it handles redisplaying the message when the mouse is dragged. This class is defined as an inner class inside the main class because it is used only in this class. Furthermore, the inner class is defined as static because it does not reference any instance members of the main class.

The `MouseMotionListener` interface contains two handlers, `mouseMoved` and `mouseDragged`, for handling mouse-motion events. When you move the mouse with a button pressed, the `mouseDragged` method is invoked to repaint the viewing area and display the

message at the mouse point. When you move the mouse without pressing a button, the `mouseMoved` method is invoked. Because the listener is interested only in the mouse-dragged event, the `mouseDragged` method is implemented (lines 36–41).

The `mouseDragged` method is invoked when you move the mouse with a button pressed. This method obtains the mouse location using the `getX` and `getY` methods (lines 38–39) in the `MouseEvent` class. This becomes the new location for the message. Invoking the `repaint()` method (line 40) causes `paintComponent` to be invoked (line 50), which displays the message in a new location.



MyProgrammingLab™

16.14 What method do you use to get the mouse-point position for a mouse event?

16.15 What is the listener interface for mouse pressed, released, clicked, entered, and exited? What is the listener interface for mouse moved and dragged?

16.9 Listener Interface Adapters



A listener interface adapter is a class that provides the default implementation for all the methods in the listener interface.

Because the methods in the `MouseListener` interface are abstract, you must implement all of them even if your program does not care about some of the events. Java provides support classes, called *listener interface adapters*, that provide default implementations for all the methods in the listener interface. The default implementation is simply an empty body. Java provides listener interface adapters for every AWT listener interface with multiple handlers. A listener interface adapter is named `XAdapter` for `XListener`. For example, `MouseMotionAdapter` is a listener interface adapter for `MouseMotionListener`. Table 16.2 lists some listener interface adapters used in this book.

listener interface adapter

TABLE 16.2 Listener Interface Adapters

<i>Adapter</i>	<i>Interface</i>
<code>MouseAdapter</code>	<code>MouseListener</code>
<code>MouseMotionAdapter</code>	<code>MouseMotionListener</code>
<code>KeyAdapter</code>	<code>KeyListener</code>
<code>WindowAdapter</code>	<code>WindowListener</code>

Using `MouseMotionAdapter`, the code in lines 34–46 in Listing 16.8 (shown in (a)) can be replaced by the following code, as shown in (b).

```
addMouseMotionListener(
    new MouseMotionListener() {
        @Override /** Handle mouse-dragged event */
        public void mouseDragged(MouseEvent e){
            x = e.getX();
            y = e.getY();
            repaint();
        }

        @Override /** Handle mouse-moved event */
        public void mouseMoved(MouseEvent e) {
        }
    });
```

(a) Using a listener interface

```
addMouseMotionListener(
    new MouseMotionAdapter() {
        @Override /** Handle mouse-dragged event */
        public void mouseDragged(MouseEvent e){
            x = e.getX();
            y = e.getY();
            repaint();
        }
    });
```

(b) Using a listener interface adapter

16.16 Why does the **ActionListener** interface have no listener interface adapter?

16.17 What is the advantage of using a listener interface adapter rather than a listener interface?



MyProgrammingLab™

16.10 Key Events

A key event is fired whenever a key is pressed, released, or typed on a component.

Key events enable the use of the keys to control and perform actions or get input from the keyboard. The **KeyEvent** object describes the nature of the event (namely, that a key has been pressed, released, or typed) and the value of the key, as shown in Figure 16.15. Java provides the **KeyListener** interface to handle key events, as shown in Figure 16.16.

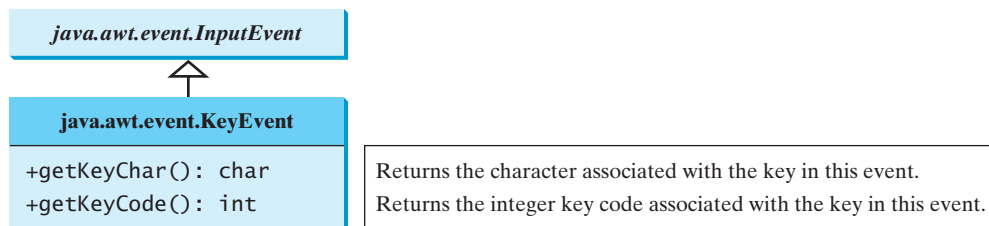


FIGURE 16.15 The **KeyEvent** class encapsulates information about key events.

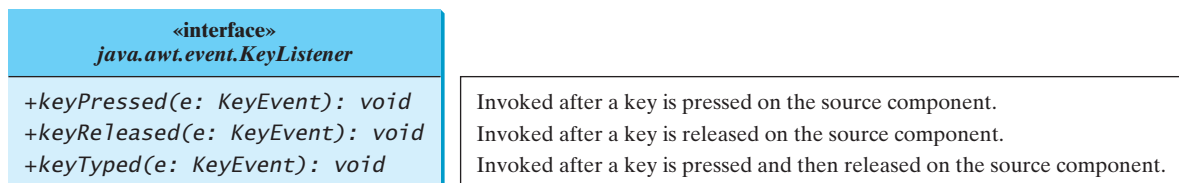


FIGURE 16.16 The **KeyListener** interface handles key pressed, released, and typed events.

The **keyPressed** handler is invoked when a key is pressed, the **keyReleased** handler is invoked when a key is released, and the **keyTyped** handler is invoked when a Unicode character is entered. If a key does not have a Unicode (e.g., function keys, modifier keys, action keys, and control keys), the **keyTyped** handler will not be invoked.

Every key event has an associated key character or key code that is returned by the **getKeyChar()** or **getKeyCode()** method in **KeyEvent**. The key codes are constants defined in the **KeyEvent** class. Table 16.3 lists some constants. See the Java API for a complete list of the constants. For a key of the Unicode character, the key code is the same as the Unicode value. For the key-pressed and key-released events, **getKeyCode()** returns the value as defined in the table. For the key-typed event, **getKeyCode()** returns **VK_UNDEFINED (0)**, and **getKeyChar()** returns the character entered.

The program in Listing 16.9 displays a user-input character. The user can move the character up, down, left, and right, using the arrow keys **VK_UP**, **VK_DOWN**, **VK_LEFT**, and **VK_RIGHT**. Figure 16.17 contains a sample run of the program.

TABLE 16.3 Key Constants

<i>Constant</i>	<i>Description</i>	<i>Constant</i>	<i>Description</i>
VK_HOME	The Home key	VK_SHIFT	The Shift key
VK_END	The End key	VK_BACK_SPACE	The Backspace key
VK_PGUP	The Page Up key	VK_CAPS_LOCK	The Caps Lock key
VK_PGDN	The Page Down key	VK_NUM_LOCK	The Num Lock key
VK_UP	The up-arrow key	VK_ENTER	The Enter key
VK_DOWN	The down-arrow key	VK_UNDEFINED	The <code>keyCode</code> unknown
VK_LEFT	The left-arrow key	VK_F1 to VK_F12	The function keys from F1 to F12
VK_RIGHT	The right-arrow key		
VK_ESCAPE	The Esc key	VK_0 to VK_9	The number keys from 0 to 9
VK_TAB	The Tab key	VK_A to VK_Z	The letter keys from A to Z
VK_CONTROL	The Control key		

**FIGURE 16.17** The program responds to key events by displaying a character and moving it up, down, left, or right.**LISTING 16.9** KeyEventDemo.java

```

1  import java.awt.*;
2  import java.awt.event.*;
3  import javax.swing.*;
4
5  public class KeyEventDemo extends JFrame {
6      private KeyboardPanel keyboardPanel = new KeyboardPanel();
7
8      /** Initialize UI */
9      public KeyEventDemo() {
10         // Add the keyboard panel to accept and display user input
11         add(keyboardPanel);
12
13         // Set focus
14         keyboardPanel.setFocusable(true);
15     }
16
17     /** Main method */
18     public static void main(String[] args) {
19         KeyEventDemo frame = new KeyEventDemo();
20         frame.setTitle("KeyEventDemo");
21         frame.setSize(300, 300);
22         frame.setLocationRelativeTo(null); // Center the frame
23         frame.setDefaultCloseOperation(JFrame.EXIT_ON_CLOSE);
24         frame.setVisible(true);
25     }
26
27     // Inner class: KeyboardPanel for receiving key input
28     static class KeyboardPanel extends JPanel {

```

create a panel

focusable

inner class

```

29 private int x = 100;
30 private int y = 100;
31 private char keyChar = 'A'; // Default key
32
33 public KeyboardPanel() {
34     addKeyListener(new KeyAdapter() {
35         @Override
36         public void keyPressed(KeyEvent e) {
37             switch (e.getKeyCode()) {
38                 case KeyEvent.VK_DOWN: y += 10; break;
39                 case KeyEvent.VK_UP: y -= 10; break;
40                 case KeyEvent.VK_LEFT: x -= 10; break;
41                 case KeyEvent.VK_RIGHT: x += 10; break;
42                 default: keyChar = e.getKeyChar();
43             }
44             repaint();
45         }
46     });
47 }
48
49 @Override /** Draw the character */
50 protected void paintComponent(Graphics g) {
51     super.paintComponent(g);
52
53     g.setFont(new Font("TimesRoman", Font.PLAIN, 24));
54     g.drawString(String.valueOf(keyChar), x, y);
55 }
56 }
57 }
58 }

```

register listener
override handler
get the key pressed
repaint
redraw character

The `KeyboardPanel` class extends `JPanel` to display a character (line 28). This class is defined as an inner class inside the main class, because it is used only in this class. Furthermore, the inner class is defined as static, because it does not reference any instance members of the main class.

Because the program gets input from the keyboard, it listens for `KeyEvent` and extends `KeyAdapter` to handle key input (line 34).

When a key is pressed, the `keyPressed` handler is invoked. The program uses `e.getKeyCode()` to obtain the key code and `e.getKeyChar()` to get the character for the key. When a nonarrow key is pressed, the character is displayed (line 42). When an arrow key is pressed, the character moves in the direction indicated by the arrow key (lines 38–41).

Only a focused component can receive `KeyEvent`. To make a component focusable, set its `focusable` property to `true` (line 14).

Every time the component is repainted, a new font is created for the `Graphics` object in line 54. This is not efficient—it would be better to create the font once as a data field.

We can now add more control for our `ControlCircle` example in Listing 16.3 to increase/decrease the circle radius by clicking the left/right mouse button or by pressing the UP and DOWN arrow keys. The new program is given in Listing 16.10.

LISTING 16.10 ControlCircleWithMouseAndKey.java

```

1 import javax.swing.*;
2 import java.awt.*;
3 import java.awt.event.*;
4
5 public class ControlCircleWithMouseAndKey extends JFrame {
6     private JButton jbtEnlarge = new JButton("Enlarge");
7     private JButton jbtShrink = new JButton("Shrink");

```

```

8     private CirclePanel canvas = new CirclePanel();
9
10    public ControlCircleWithMouseAndKey() {
11        JPanel panel = new JPanel(); // Use the panel to group buttons
12        panel.add(jbtEnlarge);
13        panel.add(jbtShrink);
14
15        this.add(canvas, BorderLayout.CENTER); // Add canvas to center
16        this.add(panel, BorderLayout.SOUTH); // Add buttons to the frame
17
18        jbtEnlarge.addActionListener(new ActionListener() {
19            @Override
20            public void actionPerformed(ActionEvent e) {
21                canvas.enlarge();
22                canvas.requestFocusInWindow();
23            }
24        });
25
26        jbtShrink.addActionListener(new ActionListener() {
27            @Override
28            public void actionPerformed(ActionEvent e) {
29                canvas.shrink();
30                canvas.requestFocusInWindow();
31            }
32        });
33
34        canvas.addMouseListener(new MouseAdapter() {
35            @Override
36            public void mouseClicked(MouseEvent e) {
37                if (e.getButton() == MouseEvent.BUTTON1)
38                    canvas.enlarge();
39                else if (e.getButton() == MouseEvent.BUTTON3)
40                    canvas.shrink();
41            }
42        });
43
44        canvas.setFocusable(true);
45        canvas.addKeyListener(new KeyAdapter() {
46            @Override
47            public void keyPressed(KeyEvent e) {
48                if (e.getKeyCode() == KeyEvent.VK_UP)
49                    canvas.enlarge();
50                else if (e.getKeyCode() == KeyEvent.VK_DOWN)
51                    canvas.shrink();
52            }
53        });
54    }
55
56    /** Main method */
57    public static void main(String[] args) {
58        JFrame frame = new ControlCircleWithMouseAndKey();
59        frame.setTitle("ControlCircle");
60        frame.setLocationRelativeTo(null); // Center the frame
61        frame.setDefaultCloseOperation(JFrame.EXIT_ON_CLOSE);
62        frame.setSize(200, 200);
63        frame.setVisible(true);
64    }
65
66    class CirclePanel extends JPanel { // Inner class
67        private int radius = 5; // Default circle radius

```

create/register listener

request focus

request focus

left button?

right button?

UP pressed?

DOWN pressed?

```

68
69     /** Enlarge the circle */
70     public void enlarge() {
71         radius++;
72         repaint();
73     }
74
75     /** Shrink the circle */
76     public void shrink() {
77         if (radius >= 1) radius--;
78         repaint();
79     }
80
81     @Override
82     protected void paintComponent(Graphics g) {
83         super.paintComponent(g);
84         g.drawOval(getWidth() / 2 - radius, getHeight() / 2 - radius,
85                 2 * radius, 2 * radius);
86     }
87 }
88 }

```

A listener for **MouseEvent** is created to handle mouse-clicked events in lines 34–42. If the left mouse button is clicked, the circle is enlarged (lines 37–38); if the right mouse button is clicked, the circle is shrunk (lines 39–40).

A listener for **KeyEvent** is created to handle key-pressed events in lines 45–53. If the UP arrow key is pressed, the circle is enlarged (lines 48–49); if the DOWN arrow key is pressed, the circle is shrunk (lines 50–51).

Invoking **setFocusable** on **canvas** makes **canvas** focusable. However, once a button is clicked, the canvas is no longer focused. Invoking **canvas.requestFocusInWindow()** (lines 22, 30) resets the focus on **canvas** so that **canvas** can listen for key events.

- 16.18** What method do you use to get the timestamp for an action event, a mouse event, or a key event?
- 16.19** What method do you use to get the key character for a key event?
- 16.20** How do you set focus on a component so it can listen for key events?
- 16.21** Does every key in the keyboard have a Unicode? Is a key code in the **KeyEvent** class equivalent to a Unicode?
- 16.22** Is the **keyPressed** handler invoked after a key is pressed? Is the **keyReleased** handler invoked after a key is released? Is the **keyTyped** handler invoked after *any* key is typed?



MyProgrammingLab™

16.11 Animation Using the **Timer** Class

A **Timer** is a source object that fires **ActionEvent** at a fixed rate.

Not all source objects are GUI components. The **javax.swing.Timer** class is a source component that fires an **ActionEvent** at a predefined rate. Figure 16.18 lists some of the methods in the class.

A **Timer** object serves as the source of an **ActionEvent**. The listeners must be instances of **ActionListener** and registered with a **Timer** object. You create a **Timer** object using its sole constructor with a delay and a listener, where **delay** specifies the number of milliseconds between two action events. You can add additional listeners using the **addActionListener** method and adjust the **delay** using the **setDelay** method. To start the timer, invoke the **start()** method; to stop the timer, invoke the **stop()** method.



javax.swing.Timer	
+Timer(delay: int, listener: ActionListener)	Creates a Timer object with a specified delay in milliseconds and an ActionListener.
+addActionListener(listener: ActionListener): void	Adds an ActionListener to the timer.
+start(): void	Starts this timer.
+stop(): void	Stops this timer.
+setDelay(delay: int): void	Sets a new delay value for this timer.

FIGURE 16.18 A **Timer** object fires an **ActionEvent** at a fixed rate.

The **Timer** class can be used to control animations. Listing 16.11 gives a program that displays two messages in separate panels (see Figure 16.19). You can use the mouse button to control the animation speed for each message. The speed increases when the left mouse button is clicked and decreases when the right button is clicked.

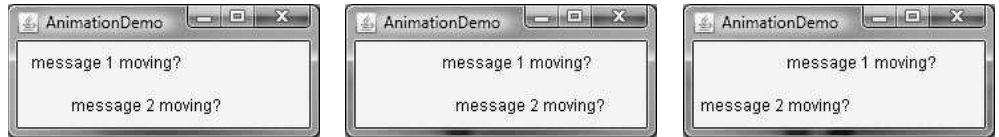


FIGURE 16.19 Two messages move in the panels.

LISTING 16.11 AnimationDemo.java

```

1  import java.awt.*;
2  import java.awt.event.*;
3  import javax.swing.*;
4
5  public class AnimationDemo extends JFrame {
6      public AnimationDemo() {
7          // Create two MovingMessagePanel for displaying two moving messages
8          this.setLayout(new GridLayout(2, 1));
9          add(new MovingMessagePanel("message 1 moving?"));
10         add(new MovingMessagePanel("message 2 moving?"));
11     }
12
13     /** Main method */
14     public static void main(String[] args) {
15         AnimationDemo frame = new AnimationDemo();
16         frame.setTitle("AnimationDemo");
17         frame.setLocationRelativeTo(null); // Center the frame
18         frame.setDefaultCloseOperation(JFrame.EXIT_ON_CLOSE);
19         frame.setSize(280, 100);
20         frame.setVisible(true);
21     }
22
23     // Inner class: Displaying a moving message
24     static class MovingMessagePanel extends JPanel {
25         private String message = "Welcome to Java";
26         private int xCoordinate = 0;
27         private int yCoordinate = 20;
28         private Timer timer = new Timer(1000, new TimerListener());

```

create message panel

create timer

```

29
30 public MovingMessagePanel(String message) {
31     this.message = message;
32
33     // Start timer for animation
34     timer.start();
35
36     // Control animation speed using mouse buttons
37     this.addMouseListener(new MouseAdapter() {
38         @Override
39         public void mouseClicked(MouseEvent e) {
40             int delay = timer.getDelay();
41             if (e.getButton() == MouseEvent.BUTTON1)
42                 timer.setDelay(delay > 10 ? delay - 10 : 0);
43             else if (e.getButton() == MouseEvent.BUTTON3)
44                 timer.setDelay(delay < 50000 ? delay + 10 : 50000);
45         }
46     });
47 }
48
49 @Override /** Paint the message */
50 protected void paintComponent(Graphics g) {
51     super.paintComponent(g);
52
53     if (xCoordinate > getWidth()) {
54         xCoordinate = -20;
55     }
56     xCoordinate += 5;
57     g.drawString(message, xCoordinate, yCoordinate);
58 }
59
60 class TimerListener implements ActionListener {
61     @Override
62     public void actionPerformed(ActionEvent e) {
63         repaint();
64     }
65 }
66 }
67 }

```

set message
 start timer
 mouse listener
 reset x-coordinate
 move message
 listener class
 event handler
 repaint

Two instances of **MovingMessagePanel** are created to display two messages (lines 9–10). The **MovingMessagePanel** class extends **JPanel** to display a message (line 24). This class is defined as an inner class inside the main class, because it is used only in this class. Furthermore, the inner class is defined as static, because it does not reference any instance members of the main class.

An inner class listener is defined in line 60 to listen for **ActionEvent** from a timer. Line 28 creates a **Timer** for the listener, and the timer is started in line 34. The timer fires an **ActionEvent** every 1 second initially, and the listener responds in line 62 to repaint the panel. When a panel is painted, its *x*-coordinate is increased (line 56), so the message is displayed to the right. When the *x*-coordinate exceeds the bound of the panel, it is reset to **-20** (line 54), so the message continues moving from left to right circularly.

A mouse listener is registered with the panel to listen for the mouse click event (lines 37–46). When the left mouse button is clicked, a new reduced delay time is set for the timer (lines 41–42). When the right mouse button is clicked, a new increased delay time is set for the timer (lines 43–44). The minimum delay time is **0** and the maximum can be **Integer.MAX_VALUE**, but it is set to **50000** in this program (line 44).

In Section 13.9, Case Study: The **StillClock** Class, you drew a **StillClock** to show the current time. The clock does not tick after it is displayed. What can you do to make the

clock display a new current time every second? The key to making the clock tick is to repaint it every second with a new current time. You can use a timer to control the repainting of the clock with the code in Listing 16.12.



VideoNote

Animate a clock

create a clock

create a timer

start timer

listener class

implement handler

set new time

repaint

LISTING 16.12 ClockAnimation.java

```

1  import java.awt.event.*;
2  import javax.swing.*;
3
4  public class ClockAnimation extends JFrame {
5      private StillClock clock = new StillClock();
6
7      public ClockAnimation() {
8          add(clock);
9
10         // Create a timer with delay 1000 ms
11         Timer timer = new Timer(1000, new TimerListener());
12         timer.start();
13     }
14
15     private class TimerListener implements ActionListener {
16         @Override /** Handle the action event */
17         public void actionPerformed(ActionEvent e) {
18             // Set new time and repaint the clock to display current time
19             clock.setCurrentTime();
20             clock.repaint();
21         }
22     }
23
24     /** Main method */
25     public static void main(String[] args) {
26         JFrame frame = new ClockAnimation();
27         frame.setTitle("ClockAnimation");
28         frame.setSize(200, 200);
29         frame.setLocationRelativeTo(null); // Center the frame
30         frame.setDefaultCloseOperation(JFrame.EXIT_ON_CLOSE);
31         frame.setVisible(true);
32     }
33 }

```

The program displays a running clock, as shown in Figure 16.20. `ClockAnimation` creates a `StillClock` (line 5). Line 11 creates a `Timer` for a `ClockAnimation`. The timer is started in line 12. The timer fires an `ActionEvent` every second, and the listener responds to set a new time (line 19) and repaint the clock (line 20). The `setCurrentTime()` method defined in `StillClock` sets the current time in the clock.

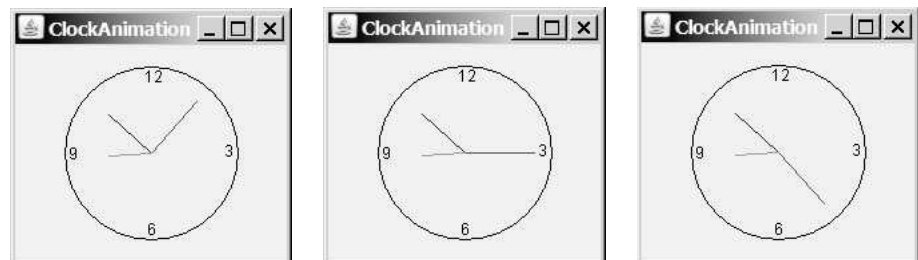


FIGURE 16.20 A live clock is displayed in the panel.

- 16.23** How do you create a timer? How do you start a timer? How do you stop a timer?
- 16.24** Does the **Timer** class have a no-arg constructor? Can you add multiple listeners to a timer?



KEY TERMS

anonymous inner class	609	event source object	602
event	602	event listener object	603
event-driven programming	602	inner class	606
event handler	604	listener interface adapter	620
event-listener interface	603	source object	602
event object	602		

CHAPTER SUMMARY

1. The root class of the event classes is **java.util.EventObject**. The subclasses of **EventObject** deal with special types of events, such as action events, window events, component events, mouse events, and key events. You can identify the source object of an event by using the **getSource()** instance method in the **EventObject** class. If a component can fire an event, any subclass of the component can fire the same type of event.
2. The listener object's class must implement the corresponding *event-listener interface*. Java provides a listener interface for every event class. The listener interface is usually named **XListener** for **XEvent**, with the exception of **MouseEventListener**. For example, the corresponding listener interface for **ActionEvent** is **ActionListener**; each listener for **ActionEvent** should implement the **ActionListener** interface. The listener interface contains the method(s), known as the *handler(s)*, which process the events.
3. The listener object must be registered by the *source object*. Registration methods depend on the event type. For **ActionEvent**, the method is **addActionListener**. In general, the method is named **addXListener** for **XEvent**.
4. An *inner class*, or *nested class*, is defined within the scope of another class. An inner class can reference the data and methods defined in the outer class in which it nests, so you need not pass the reference of the outer class to the constructor of the inner class.
5. *Listener interface adapters* are support classes that provide default implementations for all the methods in the listener interface. Java provides listener interface adapters for every AWT listener interface with multiple handlers. A listener interface adapter is named **XAdapter** for **XListener**.
6. A source object may fire several types of events. For each event, the source object maintains a list of registered listeners and notifies them by invoking the *handler* on the listener object to process the event.
7. A **MouseEvent** is fired whenever a mouse is pressed, released, clicked, entered, exited, moved, or dragged on a component. The mouse-event object captures the event, such as the number of clicks associated with it or the location (*x*- and *y*-coordinates) of the mouse point.

8. Java provides two listener interfaces, `MouseListener` and `MouseMotionListener`, to handle mouse events. Java implements the `MouseListener` interface to listen for such actions as mouse pressed, released, clicked, entered, or exited, and the `MouseMotionListener` interface to listen for such actions as mouse dragged or moved.
9. A `KeyEvent` is fired when a key is pressed, released, or typed. The key value and key character can be obtained from the key-event object.
10. A listener's `keyPressed` handler is invoked when a key is pressed, its `keyReleased` handler is invoked when a key is released, and its `keyTyped` handler is invoked when a Unicode character key is entered. If a key does not have a Unicode (e.g., function keys, modifier keys, action keys, and control keys), a listener's `keyTyped` handler will not be invoked.
11. You can use the `Timer` class to control Java animations. A timer fires an `ActionEvent` at a fixed rate. The listener updates the painting to simulate an animation.

TEST QUESTIONS

Do the test questions for this chapter online at www.cs.armstrong.edu/liang/intro9e/test.html.

MyProgrammingLab™

PROGRAMMING EXERCISES

Sections 16.2–16.7

- *16.1** (*Pick four cards*) Write a program that lets the user click the *Refresh* button to display four cards from a deck of 52 cards, as shown in Figure 16.21a. (*Hint*: See Listing 6.2 on how to draw four cards randomly.)

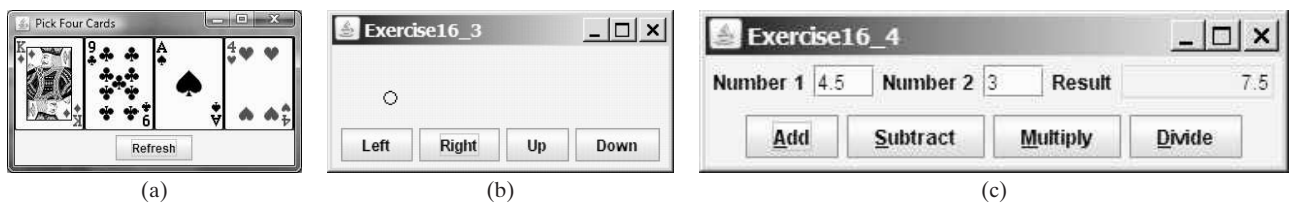


FIGURE 16.21 (a) Exercise 16.1 displays four cards randomly. (b) Exercise 16.3 uses the buttons to move the ball. (c) Exercise 16.4 performs addition, subtraction, multiplication, and division on double numbers.

- 16.2 (*Find which button has been clicked on the console*) Add the code to Programming Exercise 12.1 that will display a message on the console indicating which button has been clicked.
- *16.3** (*Move the ball*) Write a program that moves the ball in a panel. You should define a panel class for displaying the ball and provide the methods for moving the ball left, right, up, and down, as shown in Figure 16.21b. Check the boundary to prevent the ball from moving out of sight completely.
- *16.4** (*Create a simple calculator*) Write a program to perform addition, subtraction, multiplication, and division, as shown in Figure 16.21c.

- *16.5** (*Create an investment-value calculator*) Write a program that calculates the future value of an investment at a given interest rate for a specified number of years. The formula for the calculation is:

$$\text{futureValue} = \text{investmentAmount} * (1 + \text{monthlyInterestRate})^{\text{years} * 12}$$

Use text fields for the investment amount, number of years, and annual interest rate. Display the future amount in a text field when the user clicks the *Calculate* button, as shown in Figure 16.22a.

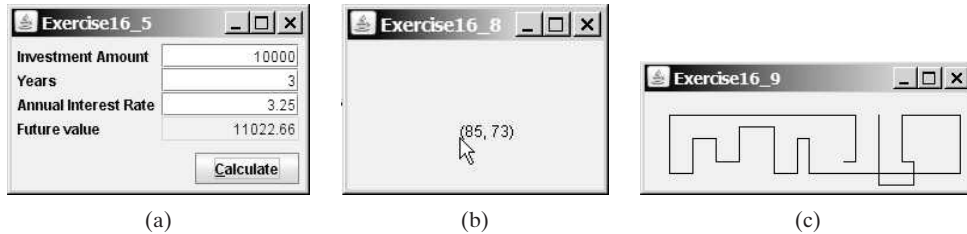


FIGURE 16.22 (a) The user enters the investment amount, years, and interest rate to compute future value. (b) Exercise 16.8 displays the mouse position. (c) Exercise 16.9 uses the arrow keys to draw the lines.

Sections 16.8–16.9

- **16.6** (*Alternate two messages*) Write a program to rotate with a mouse click the two messages **Java is fun** and **Java is powerful** displayed on a panel.
- *16.7** (*Set background color using a mouse*) Write a program that displays the background color of a panel as black when the mouse button is pressed and as white when the mouse button is released.
- *16.8** (*Display the mouse position*) Write two programs, such that one displays the mouse position when the mouse button is clicked (see Figure 16.22b) and the other displays the mouse position when the mouse button is pressed and ceases to display it when the mouse button is released.

Section 16.10

- *16.9** (*Draw lines using the arrow keys*) Write a program that draws line segments using the arrow keys. The line starts from the center of the frame and draws toward east, north, west, or south when the right-arrow key, up-arrow key, left-arrow key, or down-arrow key is pressed, as shown in Figure 16.22c.
- **16.10** (*Enter and display a string*) Write a program that receives a string from the keyboard and displays it on a panel. The *Enter* key signals the end of a string. Whenever a new string is entered, it is displayed on the panel.
- *16.11** (*Display a character*) Write a program to get a character input from the keyboard and display the character where the mouse points.

Section 16.11

- **16.12** (*Display a running fan*) Listing 13.4, *DrawArcs.java*, displays a motionless fan. Write a program that displays a running fan.
- **16.13** (*Slide show*) Twenty-five slides are stored as image files (**slide0.jpg**, **slide1.jpg**, . . . , **slide24.jpg**) in the **image** directory downloadable along with the source code in the book. The size of each image is 800×600 . Write a Java application



VideoNote

Animate a rising flag

that automatically displays the slides repeatedly. Each slide is shown for a second. The slides are displayed in order. When the last slide finishes, the first slide is redisplayed, and so on. (*Hint*: Place a label in the frame and set a slide as an image icon in the label.)

****16.14** (*Raise flag*) Write a Java program that animates raising a flag, as shown in Figure 16.1. (See Section 13.10, Displaying Images, for how to display images.)

****16.15** (*Racing car*) Write a Java program that simulates car racing, as shown in Figure 16.23a. The car moves from left to right. When it hits the right end, it restarts from the left and continues the same process. You can use a timer to control animation. Redraw the car with a new base coordinates (x, y) , as shown in Figure 16.23b. Also let the user pause/resume the animation with a button press/release and increase/decrease the car speed by pressing the UP and DOWN arrow keys.



FIGURE 16.23 (a) Exercise 16.15 displays a moving car. (b) You can redraw a car with a new base point.

***16.16** (*Display a flashing label*) Write a program that displays a flashing label. (*Hint*: To make the label flash, you need to repaint the panel alternately with the label and without it (a blank screen) at a fixed rate. Use a `boolean` variable to control the alternation.)

***16.17** (*Control a moving label*) Modify Listing 16.11, `AnimationDemo.java`, to control a moving label using the mouse. The label freezes when the mouse is pressed, and moves again when the button is released.

Comprehensive

***16.18** (*Move a circle using keys*) Write a program that moves a circle up, down, left, or right using the arrow keys.

****16.19** (*Geometry: inside a circle?*) Write a program that draws a fixed circle centered at $(100, 60)$ with radius 50 . Whenever the mouse is moved, display a message indicating whether the mouse point is inside the circle at the mouse point or outside of it, as shown in Figure 16.24a.



VideoNote

Check mouse point location

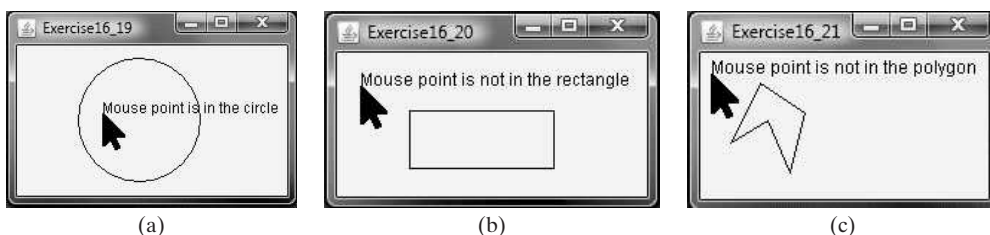


FIGURE 16.24 Detect whether a point is inside a circle, a rectangle, or a polygon.

- **16.20** (*Geometry: inside a rectangle?*) Write a program that draws a fixed rectangle centered at (100, 60) with width 100 and height 40. Whenever the mouse is moved, display a message indicating whether the mouse point is inside the rectangle at the mouse point or outside of it, as shown in Figure 16.24b. To detect whether a point is inside a rectangle, use the `MyRectangle2D` class defined in Programming Exercise 10.13.
- **16.21** (*Geometry: inside a polygon?*) Write a program that draws a fixed polygon with points at (40, 20), (70, 40), (60, 80), (45, 45), and (20, 60). Whenever the mouse is moved, display a message indicating whether the mouse point is inside the polygon at the mouse point or outside of it, as shown in Figure 16.24c. To detect whether a point is inside a polygon, use the `contains` method defined in the `Polygon` class (see Figure 13.13).
- ***16.22** (*Game: bean-machine animation*) Write a program that animates the bean machine introduced in Programming Exercise 6.21. The animation terminates after ten balls are dropped, as shown in Figure 16.25.

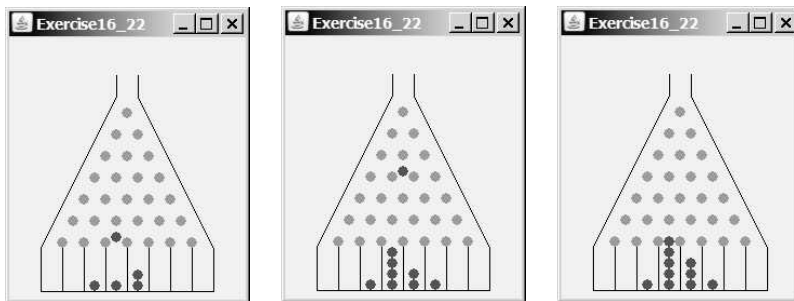


FIGURE 16.25 The balls are dropped into the bean machine.

- ***16.23** (*Geometry: closest pair of points*) Write a program that lets the user click on the panel to dynamically create points. Initially, the panel is empty. When a panel has two or more points, highlight the pair of closest points. Whenever a new point is created, a new pair of closest points is highlighted. Display the points using small circles and highlight the points using filled circles, as shown in Figure 16.26a–c. (*Hint: store the points in an `ArrayList`.*)

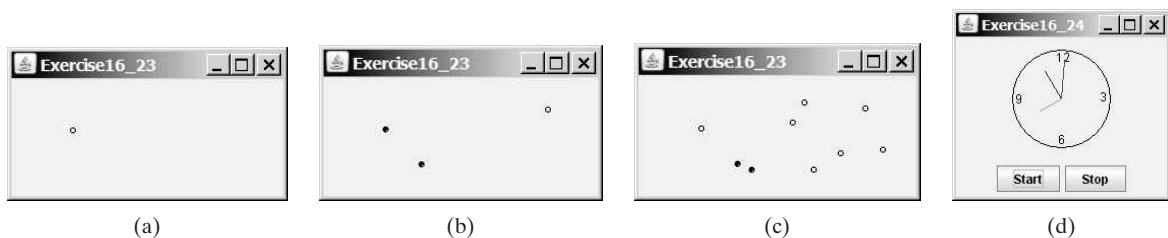


FIGURE 16.26 Exercise 16.23 allows the user to create new points with a mouse click and highlights the pair of the closest points. Exercise 16.24 allows the user to start and stop a clock.

- *16.24** (*Control a clock*) Modify Listing 16.12, `ClockAnimation.java`, to add the two methods `start()` and `stop()` to start and stop the clock. Write a program that lets the user control the clock with the *Start* and *Stop* buttons, as shown in Figure 16.26d.

*****16.25** (*Game: hit balloons*) Write a program that displays a balloon in a random position in a panel (Figure 16.27a). Use the left- and right-arrow keys to point the gun left or right to aim at the balloon (Figure 16.27b). Press the up-arrow key to fire a small ball from the gun (Figure 16.27c–d). Once the ball hits the balloon, the debris is displayed (Figure 16.27e) and a new balloon is displayed in a random location (Figure 16.27f). If the ball misses the balloon, the ball disappears once it hits the boundary of the panel. You can then press the up-arrow key to fire another ball. Whenever you press the left- or the right-arrow key, the gun turns 5 degrees left or right. (Instructors may modify the game as follows: 1. Display the number of the balloons destroyed; 2. display a countdown timer (e.g., 60 seconds) and terminate the game once the time expires; and/or 3. allow the balloon to rise dynamically.)

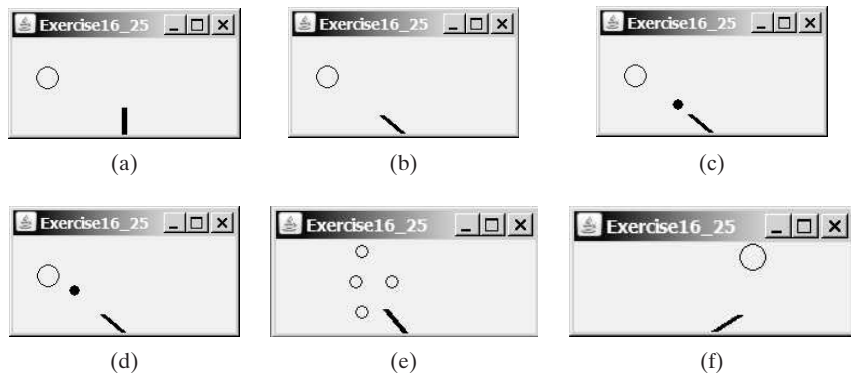


FIGURE 16.27 (a) A balloon is displayed in a random location. (b) Press the left-/right-arrow keys to aim at the balloon. (c) Press the up-arrow key to fire a ball. (d) The ball moves straight toward the balloon. (e) The ball hits the balloon. (f) A new balloon is displayed in a random position.

****16.26** (*Move a circle using mouse*) Write a program that displays a circle with radius **10** pixels. You can point the mouse inside the circle and drag (i.e., move with mouse pressed) the circle wherever the mouse goes, as shown in Figure 16.28a–b.

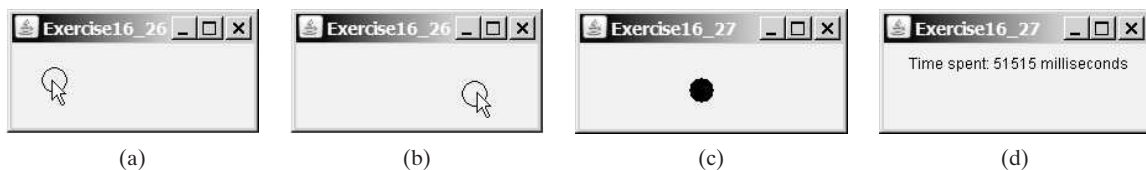


FIGURE 16.28 (a–b) You can point, drag, and move the circle. (c) When you click a circle, a new circle is displayed at a random location. (d) After 20 circles are clicked, the time spent is displayed in the panel.

*****16.27** (*Game: eye-hand coordination*) Write a program that displays a circle of radius **10** pixels filled with a random color at a random location on a panel, as shown in Figure 16.28c. When you click the circle, it disappears and a new random-color circle is displayed at another random location. After twenty circles are clicked, display the time spent in the panel, as shown in Figure 16.28d.

- ***16.28** (*Simulation: self-avoiding random walk*) A self-avoiding walk in a lattice is a path from one point to another that does not visit the same point twice. Self-avoiding walks have applications in physics, chemistry, and mathematics. They can be used to model chain-like entities such as solvents and polymers. Write a program that displays a random path that starts from the center and ends at a point on the boundary, as shown in Figure 16.29a, or ends at a dead-end point (i.e., surrounded by four points that have already been visited), as shown in Figure 16.29b. Assume the size of the lattice is 16 by 16.



FIGURE 16.29 (a) A path ends at a boundary point. (b) A path ends at dead-end point. (c–d) Animation shows the progress of a path step by step.

- ***16.29** (*Animation: self-avoiding random walk*) Revise the preceding exercise to display the walk step by step in an animation, as shown in Figure 16.29c–d.
- **16.30** (*Simulation: self-avoiding random walk*) Write a simulation program to show that the chance of getting dead-end paths increases as the grid size increases. Your program simulates lattices with size from 10 to 80. For each lattice size, simulate a self-avoiding random walk 10,000 times and display the probability of the dead-end paths, as shown in the following sample output:

```
For a lattice of size 10, the probability of dead-end paths is 10.6%
For a lattice of size 11, the probability of dead-end paths is 14.0%
. . .
For a lattice of size 80, the probability of dead-end paths is 99.5%
```



- *16.31** (*Geometry: display an n -sided regular polygon*) Programming Exercise 13.25 created the `RegularPolygonPanel` for displaying an n -sided regular polygon. Write a program that displays a regular polygon and uses two buttons named `+1` and `-1` to increase or decrease the size of the polygon, as shown in Figure 16.30a–b. Also enable the user to increase or decrease the size by clicking the right or left mouse button and by pressing the UP and DOWN arrow keys.
- **16.32** (*Geometry: add and remove points*) Write a program that lets the user click on a panel to dynamically create and remove points (see Figure 16.30c). When the user right-clicks the mouse, a point is created and displayed at the mouse point. The user can remove a point by pointing to it and left-clicking the mouse.
- **16.33** (*Geometry: pendulum*) Write a program that animates a pendulum swinging, as shown in Figure 16.31. Press the UP arrow key to increase the speed and the DOWN key to decrease it. Press the `S` key to stop animation and the `R` key to resume it.

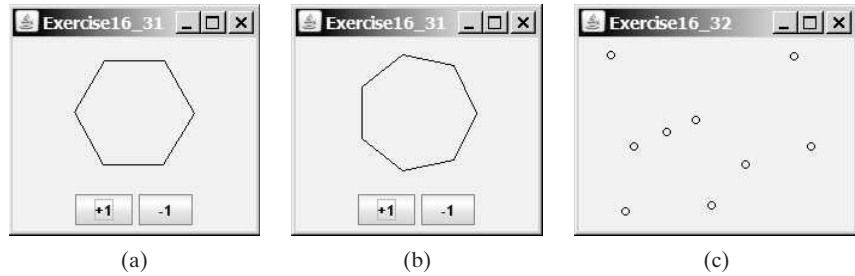


FIGURE 16.30 Clicking the +1 or -1 button increases or decreases the number of sides of a regular polygon in Exercise 16.31. Exercise 16.32 allows the user to create/remove points dynamically.



FIGURE 16.31 Exercise 16.33 animates a pendulum swinging.

- **16.34** (*Game: hangman*) Write a program that animates a hangman game swinging, as shown in Figure 16.32. Press the UP arrow key to increase the speed and the DOWN arrow key to decrease it. Press the S key to stop animation and the R key to resume it.

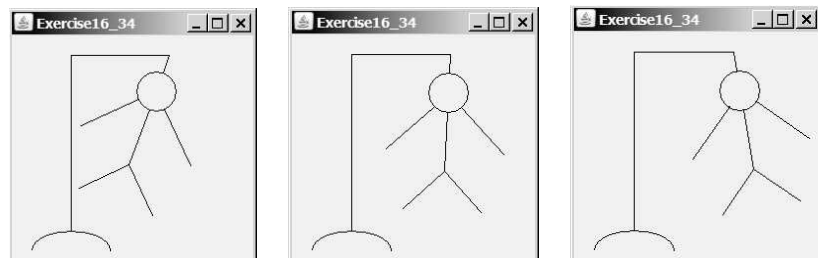


FIGURE 16.32 The program animates a hangman game swinging.

- ***16.35** (*Animation: ball on curve*) Write a program that animates a ball moving along a sine curve, as shown in Figure 16.33. When the ball gets to the right border, it starts over from the left. Enable the user to resume/pause the animation with a click on the left/right mouse button.
- *16.36** (*Flip coins*) Write a program that displays heads (H) or tails (T) for each of nine coins, as shown in Figure 16.34a–b. When a cell is clicked, the coin is flipped. A cell is a `JLabel`. Write a custom cell class that extends `JLabel`

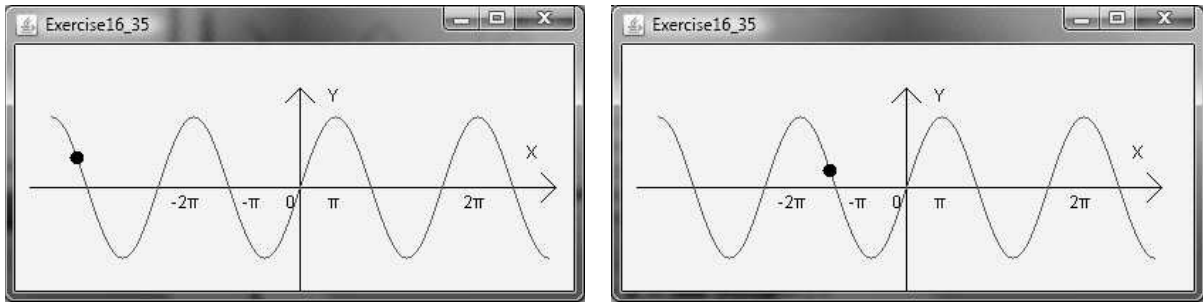


FIGURE 16.33 The program animates a ball travelling along a sine curve.

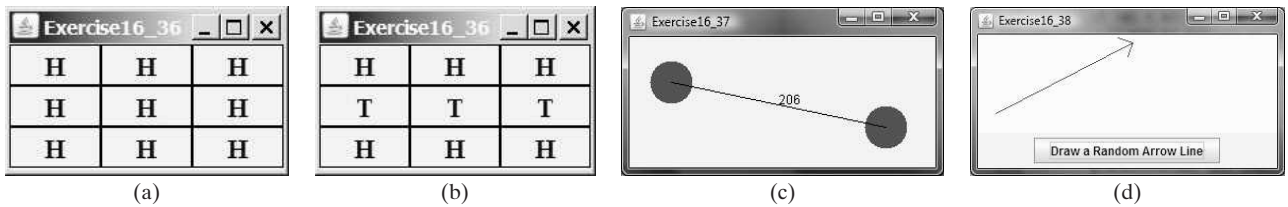


FIGURE 16.34 (a–b) Exercise 16.36 enables the user to click a cell to flip a coin. (c) The user can drag the circles. (d) Exercise 16.38 draws an arrow line randomly.

with the mouse listener for handling the clicks. When the program starts, all cells initially display **H**.

- *16.37** (*Two movable vertices and their distances*) Write a program that displays two circles with radius **20** at location **(20, 20)** and **(120, 50)** with a line connecting the two circles, as shown in Figure 16.34c. The distance between the circles is displayed along the line. The user can drag a circle. When that happens, the circle and its line are moved and the distance between the circles is updated. Your program should not allow the circles to get too close. Keep them at least **70** pixels apart between the two circles' centers.

- **16.38** (*Draw an arrow line*) Write a static method that draws an arrow line from a starting point to an ending point using the following method header:

```
public static void drawArrowLine(int x1, int y1,
    int x2, int y2, Graphics g)
```

Write a test program that randomly draws an arrow line when the *Draw a Random Arrow Line* button is clicked, as shown in Figure 16.34d.

- **16.39** (*Geometry: find the bounding rectangle*) Write a program that enables the user to add and remove points in a two-dimensional plane dynamically, as shown in Figure 16.35a–b. A minimum bounding rectangle is updated as the points are added and removed. Assume the radius of each point is **10** pixels.

- *16.40** (*Display random 0 or 1*) Write a program that displays a 10-by-10 square matrix, as shown in Figure 16.35c. Each element in the matrix is 0 or 1, randomly generated with a click of the *Refresh* button. Display each number centered in a label.

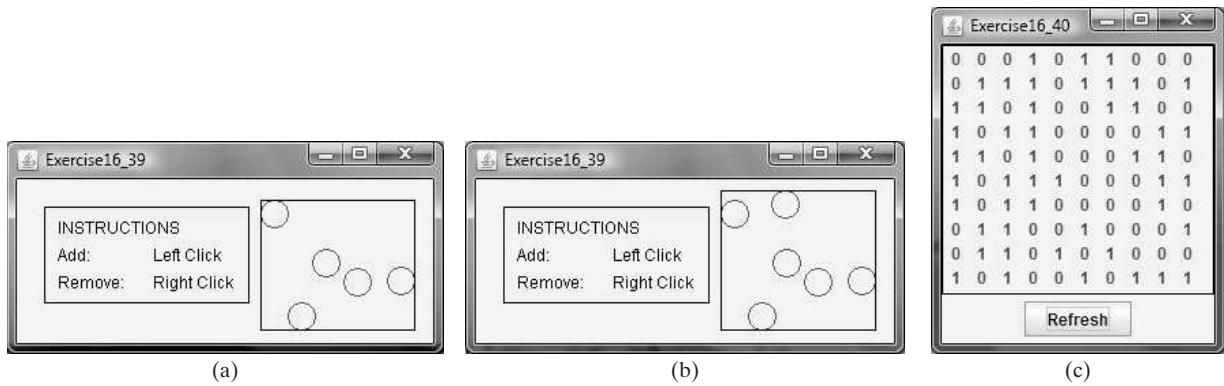


FIGURE 16.35 (a–b) Exercise 16.39 enables the user to add/remove points dynamically and displays the bounding rectangle. (c) Exercise 16.40 displays 0s and 1s randomly with a click of the *Refresh* button.

GUI COMPONENTS

Objectives

- To create graphical user interfaces with various user-interface components (§§17.2–17.8).
- To create listeners for **JCheckBox**, **JRadioButton**, and **TextField** (§17.2).
- To enter multiple-line texts using **TextArea** (§17.3).
- To select a single item using **ComboBox** (§17.4).
- To select a single or multiple items using **List** (§17.5).
- To select a range of values using **Scrollbar** (§17.6).
- To select a range of values using **Slider** and explore differences between **Scrollbar** and **Slider** (§17.7).
- To display multiple windows in an application (§17.8).



17.1 Introduction



Swing provides many GUI components for developing a comprehensive user interface.

Previous chapters briefly introduced `JButton`, `JCheckBox`, `JRadioButton`, `JLabel`, `JTextField`, and `JPasswordField`. This chapter introduces in detail how the events are processed for these components. We will also introduce `JTextArea`, `JComboBox`, `JList`, `JScrollBar`, and `JSlider`. More GUI components such as `JMenu`, `JToolBar`, `JTabbedPane`, `JSplitPane`, `JSpinner`, `JTree`, and `JTable` will be introduced in bonus Web Chapters 36–40.

17.2 Events for JCheckBox, JRadioButton, and JTextField



A GUI component may fire many types of events. `ActionEvent` is commonly processed for `JCheckBox`, `JRadioButton`, and `JTextField`, and `ItemEvent` can be used for `JCheckBox` and `JRadioButton`.

In the previous chapter, you learned how to handle an action event for `JButton`. This section introduces handling events for check boxes, radio buttons, and text fields.

When a `JCheckBox` or a `JRadioButton` is clicked (that is, checked or unchecked), it fires an `ItemEvent` and then an `ActionEvent`. When you press the *Enter* key on a `JTextField`, it fires an `ActionEvent`.

Listing 17.1 gives a program that demonstrates how to handle events from check boxes, radio buttons, and text fields. The program displays a label and allows the user to set the colors of the text in the label using radio buttons, set fonts using check boxes, and set new text entered from a text field, as shown in Figure 17.1.



FIGURE 17.1 The program demonstrates check boxes, radio buttons, and text fields.

LISTING 17.1 GUIEventDemo.java

```

1  import java.awt.*;
2  import java.awt.event.*;
3  import javax.swing.*;
4  import javax.swing.border.*;
5
6  public class GUIEventDemo extends JFrame {
7      private JLabel jlblMessage = new JLabel("Hello", JLabel.CENTER);
8
9      // Create check boxes to set the font for the message
10     private JCheckBox jchkBold = new JCheckBox("Bold");
11     private JCheckBox jchkItalic = new JCheckBox("Italic");
12
13     // Create three radio buttons to set message colors
14     private JRadioButton jrbRed = new JRadioButton("Red");
15     private JRadioButton jrbGreen = new JRadioButton("Green");
16     private JRadioButton jrbBlue = new JRadioButton("Blue");
17
18     // Create a text field for setting a new message

```

create label

create check boxes

create radio buttons

```

19 private JTextField jtfMessage = new JTextField(10);           create text field
20
21 public static void main(String[] args) {
22     GUIEventDemo frame = new GUIEventDemo();               create frame
23     frame.pack();                                           pack frame
24     frame.setTitle("GUIEventDemo");
25     frame.setLocationRelativeTo(null); // Center the frame
26     frame.setDefaultCloseOperation(JFrame.EXIT_ON_CLOSE);
27     frame.setVisible(true);
28 }
29
30 public GUIEventDemo() {                                     create UI
31     jlblMessage.setBorder(new LineBorder(Color.BLACK, 2));
32     add(jlblMessage, BorderLayout.CENTER);                 place label
33
34     // Create a panel to hold check boxes
35     JPanel jpCheckBoxes = new JPanel();                   panel for check boxes
36     jpCheckBoxes.setLayout(new GridLayout(2, 1));
37     jpCheckBoxes.add(jchkBold);
38     jpCheckBoxes.add(jchkItalic);
39     add(jpCheckBoxes, BorderLayout.EAST);
40
41     // Create a panel to hold radio buttons
42     JPanel jpRadioButtons = new JPanel();                 panel for radio buttons
43     jpRadioButtons.setLayout(new GridLayout(3, 1));
44     jpRadioButtons.add(jrbRed);
45     jpRadioButtons.add(jrbGreen);
46     jpRadioButtons.add(jrbBlue);
47     add(jpRadioButtons, BorderLayout.WEST);
48
49     // Create a radio-button group to group three buttons
50     ButtonGroup group = new ButtonGroup();                group buttons
51     group.add(jrbRed);
52     group.add(jrbGreen);
53     group.add(jrbBlue);
54
55     // Set initial message color to blue
56     jrbBlue.setSelected(true);
57     jlblMessage.setForeground(Color.blue);
58
59     // Create a panel to hold label and text field
60     JPanel jpTextField = new JPanel();                    panel for text field
61     jpTextField.setLayout(new BorderLayout(5, 0));
62     jpTextField.add(
63         new JLabel("Enter a new message"), BorderLayout.WEST);
64     jpTextField.add(jtfMessage, BorderLayout.CENTER);
65     jtfMessage.setHorizontalAlignment(JTextField.RIGHT);
66     add(jpTextField, BorderLayout.NORTH);
67
68     // Set mnemonic keys for check boxes and radio buttons
69     jchkBold.setMnemonic('B');                             set mnemonics
70     jchkItalic.setMnemonic('I');
71     jrbRed.setMnemonic('E');
72     jrbGreen.setMnemonic('G');
73     jrbBlue.setMnemonic('U');
74
75     // Register listeners with check boxes
76     jchkBold.addActionListener(new ActionListener() {     register listener
77         @Override
78         public void actionPerformed(ActionEvent e) {

```

```

79         setNewFont();
80     }
81 });
register listener 82 jchkItalic.addActionListener(new ActionListener() {
83     @Override
84     public void actionPerformed(ActionEvent e) {
85         setNewFont();
86     }
87 });
88
register listener 89 // Register listeners for radio buttons
90 jrbRed.addActionListener(new ActionListener() {
91     @Override
92     public void actionPerformed(ActionEvent e) {
93         jlblMessage.setForeground(Color.red);
94     }
95 });
register listener 96 jrbGreen.addActionListener(new ActionListener() {
97     @Override
98     public void actionPerformed(ActionEvent e) {
99         jlblMessage.setForeground(Color.green);
100    }
101 });
register listener 102 jrbBlue.addActionListener(new ActionListener() {
103     @Override
104     public void actionPerformed(ActionEvent e) {
105         jlblMessage.setForeground(Color.blue);
106     }
107 });
108
register listener 109 // Register listener for text field
110 jtfMessage.addActionListener(new ActionListener() {
111     @Override
112     public void actionPerformed(ActionEvent e) {
113         jlblMessage.setText(jtfMessage.getText());
114         jtfMessage.requestFocusInWindow();
115     }
116 });
117 }
118
119 private void setNewFont() {
120     // Determine a font style
121     int fontStyle = Font.PLAIN;
122     fontStyle += (jchkBold.isSelected() ? Font.BOLD : Font.PLAIN);
123     fontStyle += (jchkItalic.isSelected() ? Font.ITALIC : Font.PLAIN);
124
125     // Set font for the message
126     Font font = jlblMessage.getFont();
set a new font 127     jlblMessage.setFont(
128         new Font(font.getName(), fontStyle, font.getSize()));
129 }
130 }

```

The program creates a label, check boxes, radio buttons, and a text field (lines 7–19). It places a label in the center of the frame (lines 31–32), check boxes in the east (lines 35–39), radio buttons in the west (lines 42–47), and a text field in the north (lines 60–66).

mnemonic keys

The program also sets mnemonics for check boxes and radio buttons (lines 69–73). You can use a mouse click or a shortcut key to select a check box or a radio button.

The program registers action listeners for check boxes, radio buttons, and the text field (lines 76–116). register listeners

When a check box is checked or unchecked, the listener's **actionPerformed** method is invoked to process the event (lines 79, 85). The current font name and size used in **JLabel** are obtained from **jlblMessage.getFont()** using the **getName()** and **getSize()** methods (line 128). The font styles (**Font.BOLD** and **Font.ITALIC**) are specified in the check boxes. If no font style is selected, the default font style is **Font.PLAIN** (line 121). The font style is an integer **0** for **Font.PLAIN**, **1** for **Font.BOLD**, and **2** for **Font.ITALIC**. The font style can be combined by adding together the integers that represent the fonts (lines 122–123). For example, **Font.BOLD + Font.ITALIC** is **3**, which represents a combined font of bold and italic. check boxes

The **setFont** method (line 127) defined in the **Component** class is inherited in the **JLabel** class. This method automatically invokes the **repaint** method. Invoking **setFont** on **jlblMessage** automatically repaints **jlblMessage**.

A check box fires an **ItemEvent** and then an **ActionEvent** when it is clicked. You could process either the **ItemEvent** or the **ActionEvent** to redisplay the message. The program in this example processes the **ActionEvent**. If you want to process the **ItemEvent**, create a listener for **ItemEvent** and register it with a check box. The listener must implement the **itemStateChanged** handler to process an **ItemEvent**. For example, the following code registers an **ItemListener** with **jchkBold**:

```
// To listen for ItemEvent
jchkBold.addItemListener(new ItemListener() {
    @Override /** Handle ItemEvent */
    public void itemStateChanged(ItemEvent e) {
        setNewFont();
    }
});
```

When a radio button is clicked, its action event listener sets the corresponding foreground color in **jlblMessage** (lines 93, 99, 105). radio buttons

The program creates a **ButtonGroup** and puts three **JRadioButton** instances (**jrbRed**, **jrbGreen**, and **jrbBlue**) in the group (lines 50–53) so they can only be selected exclusively—the text will be either red or green or blue. radio button group

A radio button fires an **ItemEvent** and then an **ActionEvent** when it is selected or deselected. You could process either the **ItemEvent** or the **ActionEvent** to choose a color. This program processes the **ActionEvent**. As an exercise, rewrite the code using the **ItemEvent**.

After you type a new message in the text field and press the *Enter* key, a new message is displayed. Pressing the *Enter* key on the text field triggers an action event. The listener sets a new message in **jlblMessage** (line 113). ActionEvent for
JTextField

The **requestFocusInWindow()** method (line 114) defined in the **Component** class requests the component to receive input focus. Thus, **jtfMessage.requestFocusInWindow()** requests the input focus on **jtfMessage**. You will see the cursor on **jtfMessage** after the **actionPerformed** method is invoked. requestFocusInWindow()

The **pack()** method (line 23) automatically sizes the frame according to the size of the components placed in it. pack()

- 17.1 Can a **JButton**, **JLabel**, **JCheckBox**, **JRadioButton**, and **JTextField** fire an **ActionEvent**?
- 17.2 Can a **JButton**, **JLabel**, **JCheckBox**, **JRadioButton**, and **JTextField** fire an **ItemEvent**?
- 17.3 What happens after invoking **jtfMessage.requestFocusInWindow()**?



17.3 Text Areas



A **JTextArea** enables the user to enter multiple lines of text.

If you want to let the user enter multiple lines of text, you may create several instances of **JTextField**. A better alternative is to use **JTextArea**, which enables the user to enter multiple lines of text. Figure 17.2 lists the constructors and methods in **JTextArea**.

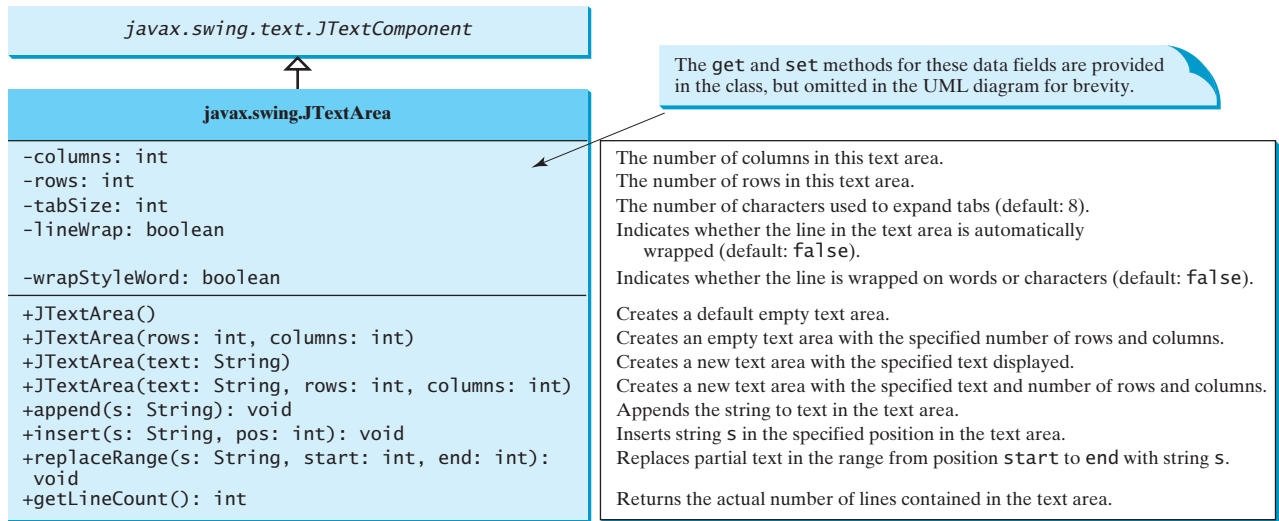


FIGURE 17.2 **JTextArea** enables you to enter or display multiple lines of characters.

Like **JTextField**, **JTextArea** inherits **JTextComponent**, which contains the methods **getText**, **setText**, **isEditable**, and **setEditable**. You can specify whether a line is wrapped in the **lineWrap** property. If **lineWrap** is true, you can specify how line is wrapped in the **wrapStyleWord** property. If **wrapStyleWord** is true, line is wrapped on words. If it is false, line is wrapped on characters. The following example creates a text area with 5 rows and 20 columns, line-wrapped on words, red foreground color, and Courier font, bold, 20 pixels.

wrap line
wrap word

```

JTextArea jtaNote = new JTextArea("This is a text area", 5, 20);
jtaNote.setLineWrap(true);
jtaNote.setWrapStyleWord(true);
jtaNote.setForeground(Color.red);
jtaNote.setFont(new Font("Courier", Font.BOLD, 20));
  
```

JTextArea does not handle scrolling, but you can create a **JScrollPane** object to hold an instance of **JTextArea** and let **JScrollPane** handle scrolling for **JTextArea**, as follows:

```

// Create a scroll pane to hold text area
JScrollPane scrollPane = new JScrollPane(jtaNote);
add(scrollPane, BorderLayout.CENTER);
  
```

JScrollPane



Tip

You can place any swing GUI component in a **JScrollPane**. **JScrollPane** provides vertical and horizontal scrolling automatically if the component is too large to fit in the viewing area.

Listing 17.3 gives a program that displays an image and a text in a label, and a text in a text area, as shown in Figure 17.3.

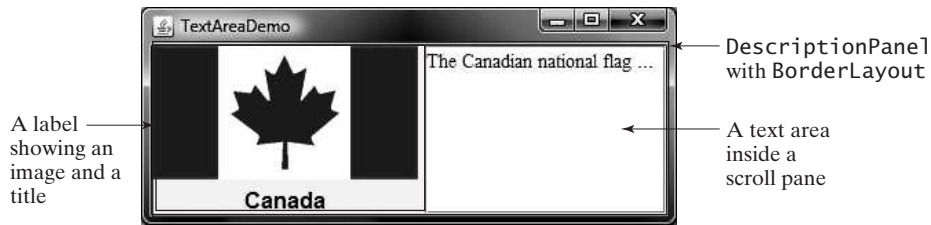


FIGURE 17.3 The program displays an image in a label, a title in a label, and text in the text area.

Here are the major steps in the program:

1. Define a class named `DescriptionPanel` that extends `JPanel`, as shown in Listing 17.2. This class contains a text area inside a scroll pane, and a label for displaying an image icon and a title. The class `DescriptionPanel` will be reused in later examples.
2. Define a class named `TextAreaDemo` that extends `JFrame`, as shown in Listing 17.3. Create an instance of `DescriptionPanel` and add it to the center of the frame. The relationship between `DescriptionPanel` and `TextAreaDemo` is shown in Figure 17.4.

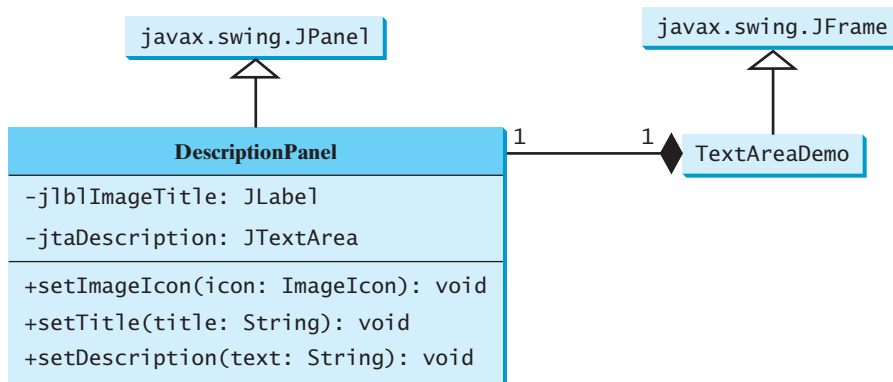


FIGURE 17.4 `TextAreaDemo` uses `DescriptionPanel` to display an image, title, and text description of a national flag.

LISTING 17.2 `DescriptionPanel.java`

```

1  import javax.swing.*;
2  import java.awt.*;
3
4  public class DescriptionPanel extends JPanel {
5      /** Label for displaying an image icon and a title */
6      private JLabel lblImageTitle = new JLabel();
7
8      /** Text area for displaying text */
9      private JTextArea jtaDescription = new JTextArea();
10
11     public DescriptionPanel() {
12         // Center the icon and text and place the text under the icon
13         lblImageTitle.setHorizontalAlignment(JLabel.CENTER);
14         lblImageTitle.setHorizontalTextPosition(JLabel.CENTER);
15         lblImageTitle.setVerticalTextPosition(JLabel.BOTTOM);
16

```

```

17     // Set the font in the label and the text field
18     jlblImageTitle.setFont(new Font("SansSerif", Font.BOLD, 16));
19     jtaDescription.setFont(new Font("Serif", Font.PLAIN, 14));
20
21     // Set lineWrap and wrapStyleWord true for the text area
22     jtaDescription.setLineWrap(true);
23     jtaDescription.setWrapStyleWord(true);
24     jtaDescription.setEditable(false);
25
26     // Create a scroll pane to hold the text area
27     JScrollPane scrollPane = new JScrollPane(jtaDescription);
28
29     // Set BorderLayout for the panel, add label and scroll pane
30     setLayout(new BorderLayout(5, 5));
31     add(scrollPane, BorderLayout.CENTER);
32     add(jlblImageTitle, BorderLayout.WEST);
33 }
34
35 /** Set the title */
36 public void setTitle(String title) {
37     jlblImageTitle.setText(title);
38 }
39
40 /** Set the image icon */
41 public void setImageIcon(ImageIcon icon) {
42     jlblImageTitle.setIcon(icon);
43 }
44
45 /** Set the text description */
46 public void setDescription(String text) {
47     jtaDescription.setText(text);
48 }
49 }

```

wrap line
wrap word
read only

scroll pane

The text area is inside a `JScrollPane` (line 27), which provides scrolling functions for the text area. Scroll bars automatically appear if there is more text than the physical size of the text area.

The `lineWrap` property is set to `true` (line 22) so that the line is automatically wrapped when the text cannot fit in one line. The `wrapStyleWord` property is set to `true` (line 23) so that the line is wrapped on words rather than characters. The text area is set as noneditable (line 24), so you cannot edit the description in the text area.

It is not necessary to create a separate class for `DescriptionPanel` in this example. However, this class was created for reuse in the next section, where you will use it to display a description panel for various images.

LISTING 17.3 TextAreaDemo.java

```

1  import java.awt.*;
2  import javax.swing.*;
3
4  public class TextAreaDemo extends JFrame {
5      // Declare and create a description panel
6      private DescriptionPanel descriptionPanel = new DescriptionPanel();
7
8      public static void main(String[] args) {
9          TextAreaDemo frame = new TextAreaDemo();
10         frame.pack();
11         frame.setLocationRelativeTo(null); // Center the frame

```

create descriptionPanel

create frame

```

12     frame.setDefaultCloseOperation(JFrame.EXIT_ON_CLOSE);
13     frame.setTitle("TextAreaDemo");
14     frame.setVisible(true);
15 }
16
17 public TextAreaDemo() {                                create UI
18     // Set title, text, and image in the description panel
19     descriptionPanel.setTitle("Canada");
20     String description = "The Canadian national flag...";
21     descriptionPanel.setImageIcon(new ImageIcon("image/ca.gif"));
22     descriptionPanel.setDescription(description);
23
24     // Add the description panel to the frame
25     setLayout(new BorderLayout());
26     add(descriptionPanel, BorderLayout.CENTER);        add descriptionPanel
27 }
28 }

```

The program in Listing 17.3 creates an instance of **DescriptionPanel** (line 6) and sets the title (line 19), image (line 21), and text in the description panel (line 22). **DescriptionPanel** is a subclass of **JPanel**. **DescriptionPanel** contains a label for displaying an image icon and a text title, and a text area for displaying a description of the image.

- 17.4** How do you create a text area with **10** rows and **20** columns?
- 17.5** How do you insert or append three lines into the text area?
- 17.6** How do you create a scrollable text area?
- 17.7** What method do you use to get the text from a text area? How do you get the line count in the text area?
- 17.8** How do you specify a line wrap? How do you specify wrapping on characters? How do you specify wrapping on words?



17.4 Combo Boxes

A combo box, *also known as a choice list or drop-down list, contains a list of items from which the user can choose.*



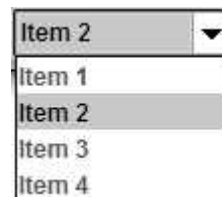
A combo box is useful for limiting a user's range of choices and avoids the cumbersome validation of data input. Figure 17.5 lists several frequently used constructors and methods in **JComboBox**.

The following statements create a combo box with four items, red foreground, white background, and the second item selected.

```

JComboBox jcb = new JComboBox(new Object[]
    {"Item 1", "Item 2", "Item 3", "Item 4"});
jcb.setForeground(Color.red);
jcb.setBackground(Color.white);
jcb.setSelectedItem("Item 2");

```



JComboBox can fire **ItemEvent** and **ActionEvent** among many other events. Whenever an item is selected, an **ActionEvent** is fired. Whenever a new item is selected, **JComboBox** fires **ItemEvent** twice: once for deselecting the previously selected item, and the other for selecting the currently selected item. Note that no **ItemEvent** is fired if the current item is reselected. To respond to an **ItemEvent**, you need to implement the **itemStateChanged(ItemEvent e)** handler for processing a choice. To get data from a **JComboBox** menu, you can use **getSelectedItem()** to return the currently selected item, or the **e.getItem()** method to get the item from the **itemStateChanged(ItemEvent e)** handler.

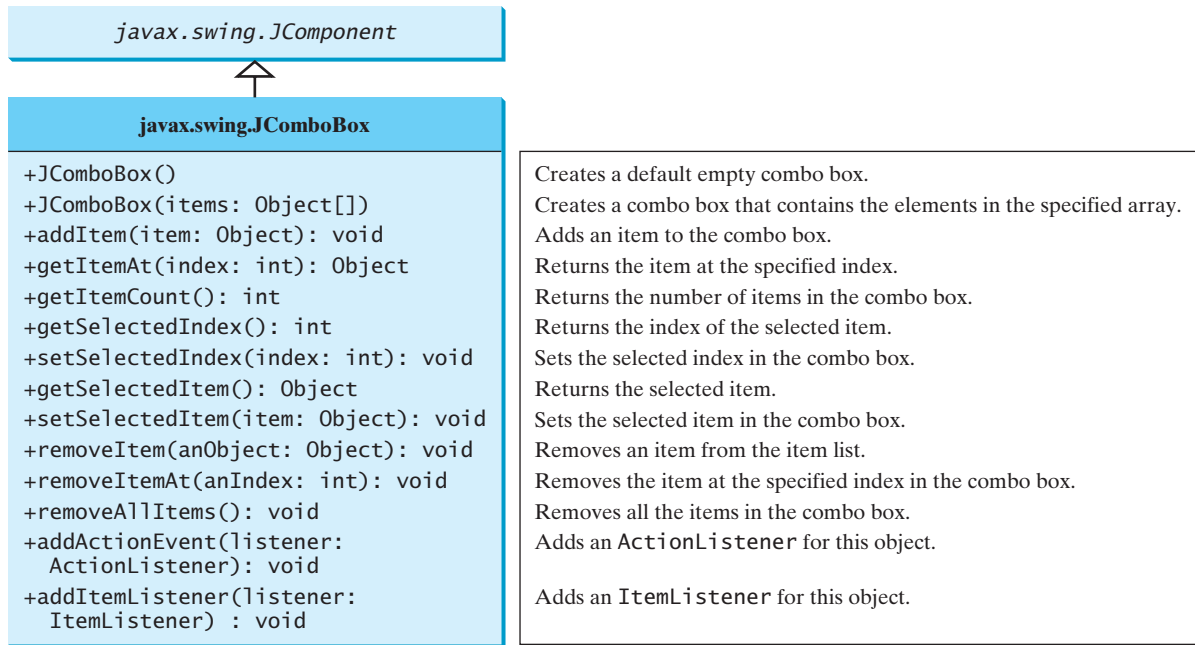


FIGURE 17.5 `JComboBox` enables you to select an item from a set of items.

Listing 17.4 gives a program that lets users view an image and a description of a country's flag by selecting the country from a combo box, as shown in Figure 17.6.

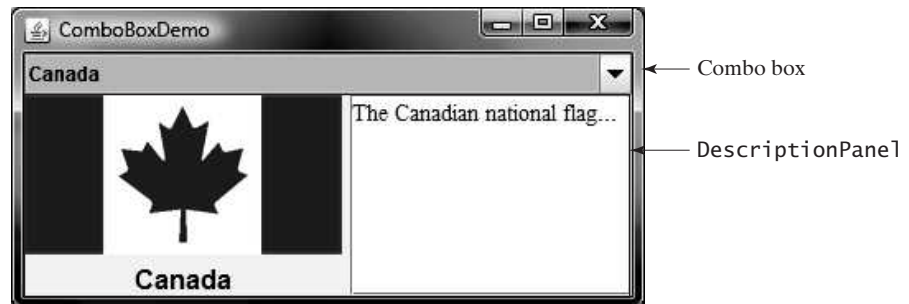


FIGURE 17.6 Information about a country, including an image and a description of its flag, is displayed when the country is selected in the combo box.

Here are the major steps in the program:

1. Create the user interface.
Create a combo box with country names as its selection values. Create a `DescriptionPanel` object (the `DescriptionPanel` class was introduced in the preceding section). Place the combo box in the north of the frame and the description panel in the center of the frame.
2. Process the event.
Create a listener to implement the `itemStateChanged` handler to set the flag title, image, and text in the description panel for the selected country name.

LISTING 17.4 ComboBoxDemo.java

```

1  import java.awt.*;
2  import java.awt.event.*;
3  import javax.swing.*;
4
5  public class ComboBoxDemo extends JFrame {
6      // Create an array of Strings for flag titles
7      private String[] flagTitles = {"Canada", "China", "Denmark",
8          "France", "Germany", "India", "Norway", "United Kingdom",
9          "United States of America"};
10
11     // Declare an ImageIcon array for the national flags of 9 countries
12     private ImageIcon[] flagImage = {
13         new ImageIcon("image/ca.gif"),
14         new ImageIcon("image/china.gif"),
15         new ImageIcon("image/denmark.gif"),
16         new ImageIcon("image/fr.gif"),
17         new ImageIcon("image/germany.gif"),
18         new ImageIcon("image/india.gif"),
19         new ImageIcon("image/norway.gif"),
20         new ImageIcon("image/uk.gif"),
21         new ImageIcon("image/us.gif")
22     };
23
24     // Declare an array of strings for flag descriptions
25     private String[] flagDescription = new String[9];
26
27     // Declare and create a description panel
28     private DescriptionPanel descriptionPanel = new DescriptionPanel();
29
30     // Create a combo box for selecting countries
31     private JComboBox jcbo = new JComboBox(flagTitles);
32
33     public static void main(String[] args) {
34         ComboBoxDemo frame = new ComboBoxDemo();
35         frame.pack();
36         frame.setTitle("ComboBoxDemo");
37         frame.setLocationRelativeTo(null); // Center the frame
38         frame.setDefaultCloseOperation(JFrame.EXIT_ON_CLOSE);
39         frame.setVisible(true);
40     }
41
42     public ComboBoxDemo() {
43         // Set text description
44         flagDescription[0] = "The Canadian national flag...";
45         flagDescription[1] = "Description for China ... ";
46         flagDescription[2] = "Description for Denmark ... ";
47         flagDescription[3] = "Description for France ... ";
48         flagDescription[4] = "Description for Germany ... ";
49         flagDescription[5] = "Description for India ... ";
50         flagDescription[6] = "Description for Norway ... ";
51         flagDescription[7] = "Description for UK ... ";
52         flagDescription[8] = "Description for US ... ";
53
54         // Set the first country (Canada) for display
55         setDisplay(0);
56
57         // Add combo box and description panel to the frame
58         add(jcbo, BorderLayout.NORTH);

```

country

image icon

description

combo box

create UI

listener

```

59     add(descriptionPanel, BorderLayout.CENTER);
60
61     // Register listener
62     jcbo.addItemListener(new ItemListener() {
63         @Override /** Handle item selection */
64         public void itemStateChanged(ItemEvent e) {
65             setDisplay(jcbo.getSelectedIndex());
66         }
67     });
68 }
69
70 /** Set display information on the description panel */
71 public void setDisplay(int index) {
72     descriptionPanel.setTitle(flagTitles[index]);
73     descriptionPanel.setImageIcon(flagImage[index]);
74     descriptionPanel.setDescription(flagDescription[index]);
75 }
76 }

```

The listener listens to **ItemEvent** from the combo box and implements **ItemListener** (lines 62–67). Instead of using **ItemEvent**, you could rewrite the program to use **ActionEvent** for handling combo-box item selection.

The program stores the flag information in three arrays: **flagTitles**, **flagImage**, and **flagDescription** (lines 7–25). The array **flagTitles** contains the names of nine countries, the array **flagImage** contains images of the nine countries' flags, and the array **flagDescription** contains descriptions of the flags.

The program creates an instance of **DescriptionPanel** (line 28), which was presented in Listing 17.2, `DescriptionPanel.java`. The program creates a combo box with initial values from **flagTitles** (line 31). When the user selects an item in the combo box, the **itemStateChanged** handler is executed. The handler finds the selected index and sets its corresponding flag title, flag image, and flag description on the panel.



MyProgrammingLab™

- 17.9** How do you create a combo box and add three items to it?
- 17.10** How do you retrieve an item from a combo box? How do you retrieve a selected item from a combo box?
- 17.11** How do you get the number of items in a combo box? How do you retrieve an item at a specified index in a combo box?
- 17.12** What events would a **JComboBox** fire upon selecting a new item?

17.5 Lists



A list is a component that basically performs the same function as a combo box, but it enables the user to choose a single value or multiple values.

The Swing **JList** is very versatile. Figure 17.7 lists several frequently used constructors and methods in **JList**.

SelectionMode is one of the three values (**SINGLE_SELECTION**, **SINGLE_INTERVAL_SELECTION**, and **MULTIPLE_INTERVAL_SELECTION**) defined in **javax.swing.ListSelectionMode** that indicate whether a single item, single-interval item, or multiple-interval item can be selected. Single selection allows only one item to be selected. Single-interval selection allows multiple selections, but the selected items must be contiguous. Multiple-interval selection allows selections of multiple contiguous items without restrictions, as shown in Figure 17.8. The default value is **MULTIPLE_INTERVAL_SELECTION**.

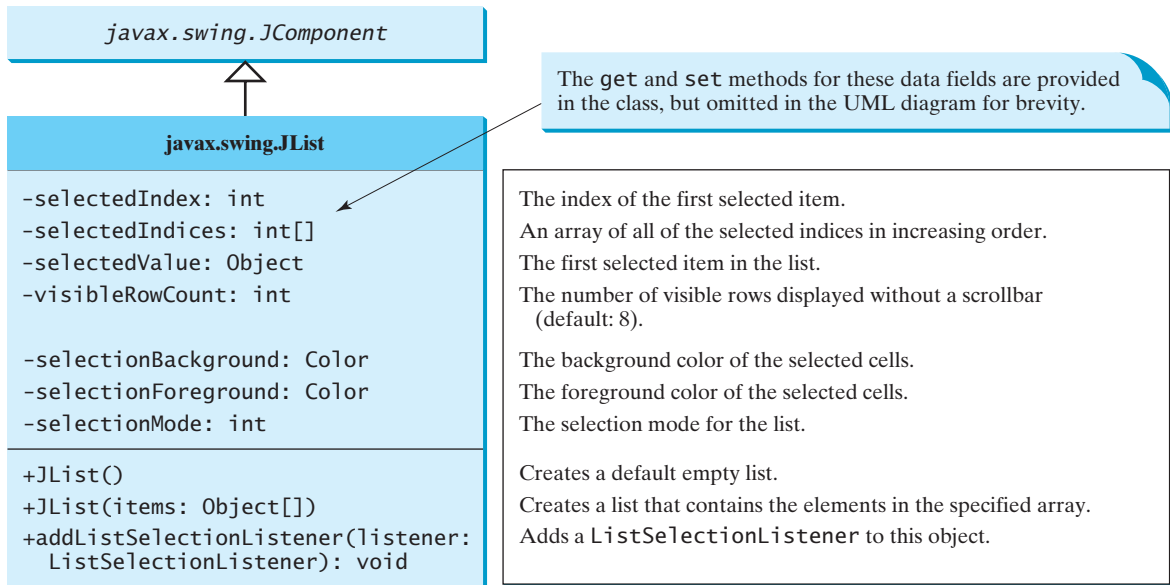


FIGURE 17.7 `JList` enables you to select multiple items from a set of items.

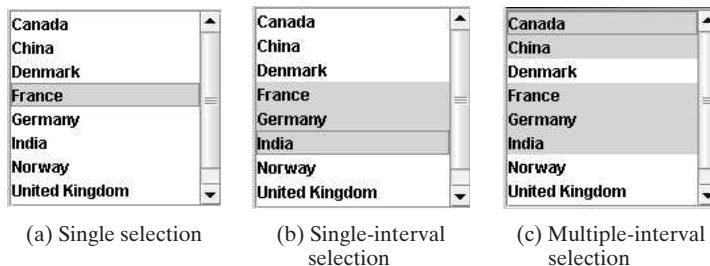


FIGURE 17.8 `JList` has three selection modes: single selection, single-interval selection, and multiple-interval selection.

The following statements create a list with six items, **red** foreground, **white** background, **pink** selection foreground, **black** selection background, and visible row count **4**.

```

1 JList jlst = new JList(new String[]
2   {"Item 1", "Item 2", "Item 3", "Item 4", "Item 5", "Item 6"});
3 jlst.setForeground(Color.RED);
4 jlst.setBackground(Color.WHITE);
5 jlst.setSelectionForeground(Color.PINK);
6 jlst.setSelectionBackground(Color.BLACK);
7 jlst.setVisibleRowCount(4);

```

Lists do not scroll automatically. To make a list scrollable, create a scroll pane and add the list to it.

`JList` fires `javax.swing.event.ListSelectionEvent` to notify the listeners of the selections. The listener must implement the `valueChanged` handler in the `javax.swing.event.ListSelectionListener` interface to process the event.

Listing 17.5 gives a program that lets users select countries in a list and displays the flags of the selected countries in the labels. Figure 17.9 shows a sample run of the program.

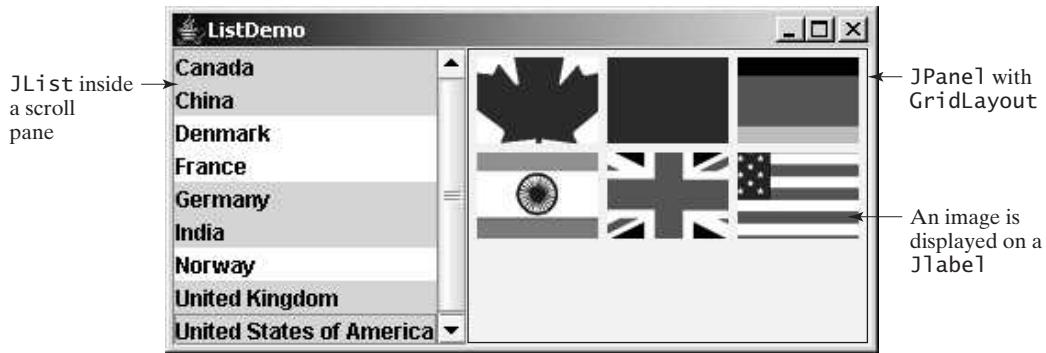


FIGURE 17.9 When the countries in the list are selected, corresponding images of their flags are displayed in the labels.

Here are the major steps in the program:

1. Create the user interface.
Create a list with nine country names as selection values, and place the list inside a scroll pane. Place the scroll pane in the west of the frame. Create nine labels to be used to display the countries' flag images. Place the labels in the panel, and place the panel in the center of the frame.
2. Process the event.
Create a listener to implement the `valueChanged` method in the `ListSelectionListener` interface to set the selected countries' flag images in the labels.

LISTING 17.5 ListDemo.java

```

1  import java.awt.*;
2  import javax.swing.*;
3  import javax.swing.event.*;
4
5  public class ListDemo extends JFrame {
6      final int NUMBER_OF_FLAGS = 9;
7
8      // Declare an array of Strings for flag titles
9      private String[] flagTitles = {"Canada", "China", "Denmark",
10     "France", "Germany", "India", "Norway", "United Kingdom",
11     "United States of America"};
12
13     // The list for selecting countries
14     private JList jlst = new JList(flagTitles);
15
16     // Declare an ImageIcon array for the national flags of 9 countries
17     private ImageIcon[] imageIcons = {
18         new ImageIcon("image/ca.gif"),
19         new ImageIcon("image/china.gif"),
20         new ImageIcon("image/denmark.gif"),
21         new ImageIcon("image/fr.gif"),
22         new ImageIcon("image/germany.gif"),
23         new ImageIcon("image/india.gif"),
24         new ImageIcon("image/norway.gif"),
25         new ImageIcon("image/uk.gif"),
26         new ImageIcon("image/us.gif")
27     };
28

```



```

29 // Arrays of labels for displaying images
30 private JLabel[] jlblImageViewer = new JLabel[NUMBER_OF_FLAGS];
31
32 public static void main(String[] args) {
33     ListDemo frame = new ListDemo();           create frame
34     frame.setSize(650, 500);
35     frame.setTitle("ListDemo");
36     frame.setLocationRelativeTo(null); // Center the frame
37     frame.setDefaultCloseOperation(JFrame.EXIT_ON_CLOSE);
38     frame.setVisible(true);
39 }
40
41 public ListDemo() {
42     // Create a panel to hold nine labels
43     JPanel p = new JPanel(new GridLayout(3, 3, 5, 5));   create UI
44
45     for (int i = 0; i < NUMBER_OF_FLAGS; i++) {
46         p.add(jlblImageViewer[i] = new JLabel());
47         jlblImageViewer[i].setHorizontalAlignment
48             (SwingConstants.CENTER);
49     }
50
51     // Add p and the list to the frame
52     add(p, BorderLayout.CENTER);
53     add(new JScrollPane(jlst), BorderLayout.WEST);
54
55     // Register listeners
56     jlst.addListSelectionListener(new ListSelectionListener() {
57         @Override /** Handle list selection */
58         public void valueChanged(ListSelectionEvent e) {   event handler
59             // Get selected indices
60             int[] indices = jlst.getSelectedIndices();
61
62             int i;
63             // Set icons in the labels
64             for (i = 0; i < indices.length; i++) {
65                 jlblImageViewer[i].setIcon(imageIcons[indices[i]]);
66             }
67
68             // Remove icons from the rest of the labels
69             for (; i < NUMBER_OF_FLAGS; i++) {
70                 jlblImageViewer[i].setIcon(null);
71             }
72         }
73     });
74 }
75 }

```

The anonymous inner-class listener listens to `ListSelectionEvent` for handling the selection of country names in the list (lines 56–73). `ListSelectionEvent` and `ListSelectionListener` are defined in the `javax.swing.event` package, so this package is imported into the program (line 3).

The program creates an array of nine labels for displaying flag images for nine countries. The program loads the images of the nine countries into an image array (lines 17–27) and creates a list of the nine countries in the same order as in the title array (lines 9–11). Thus, the index `0` of the image array corresponds to the first country in the list.

The list is placed in a scroll pane (line 53) so that it can be scrolled when the number of items in the list extends beyond the viewing area.

By default, the selection mode of the list is multiple-interval, which allows the user to select multiple items from different blocks in the list. When the user selects countries in the list, the `valueChanged` handler (lines 58–72) is executed, which gets the indices of the selected items and sets their corresponding image icons in the label to display the flags.



MyProgrammingLab™

17.13 How do you create a list with an array of strings?

17.14 How do you set the visible row count in a list?

17.15 What selection modes are available for a list? How do you set a selection mode?

17.16 How do you set the foreground and background color of a list? How do you set the foreground and background color of the selected items?

17.6 Scroll Bars



JScrollBar is a component that enables the user to select from a range of values.

Figure 17.10 shows a scroll bar. Normally, the user changes the value of the scroll bar by making a gesture with the mouse. For example, the user can drag the scroll bar's bubble up and down, or click in the scroll bar's unit-increment or block-increment areas. Keyboard gestures can also be mapped to the scroll bar. By convention, the *Page Up* and *Page Down* keys are equivalent to clicking in the scroll bar's block-increment and block-decrement areas.

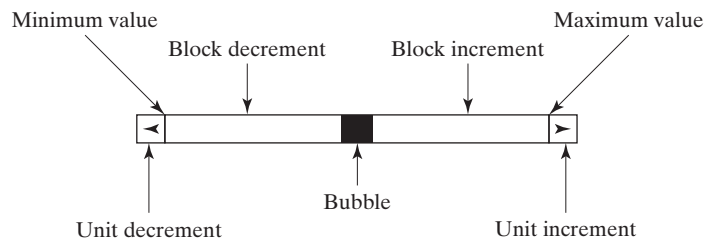


FIGURE 17.10 A scroll bar represents a range of values graphically.



Note

The width of the scroll bar's track corresponds to `maximum + visibleAmount`. When a scroll bar is set to its maximum value, the left side of the bubble is at `maximum`, and the right side is at `maximum + visibleAmount`.

JScrollBar has the following properties, as shown in Figure 17.11.

When the user changes the value of the scroll bar, the scroll bar fires an `AdjustmentEvent`. A listener class for this event must implement the `adjustmentValueChanged` handler in the `java.awt.event.AdjustmentListener` interface.

Listing 17.6 gives a program that uses horizontal and vertical scroll bars to control a message displayed on a panel. The horizontal scroll bar is used to move the message to the left and the right, and the vertical scroll bar to move it up and down. A sample run of the program is shown in Figure 17.12.

Here are the major steps in the program:

1. Create the user interface.

Create a `MessagePanel` object and place it in the center of the frame. Create a vertical scroll bar and place it in the east of the frame. Create a horizontal scroll bar and place it in the south of the frame.

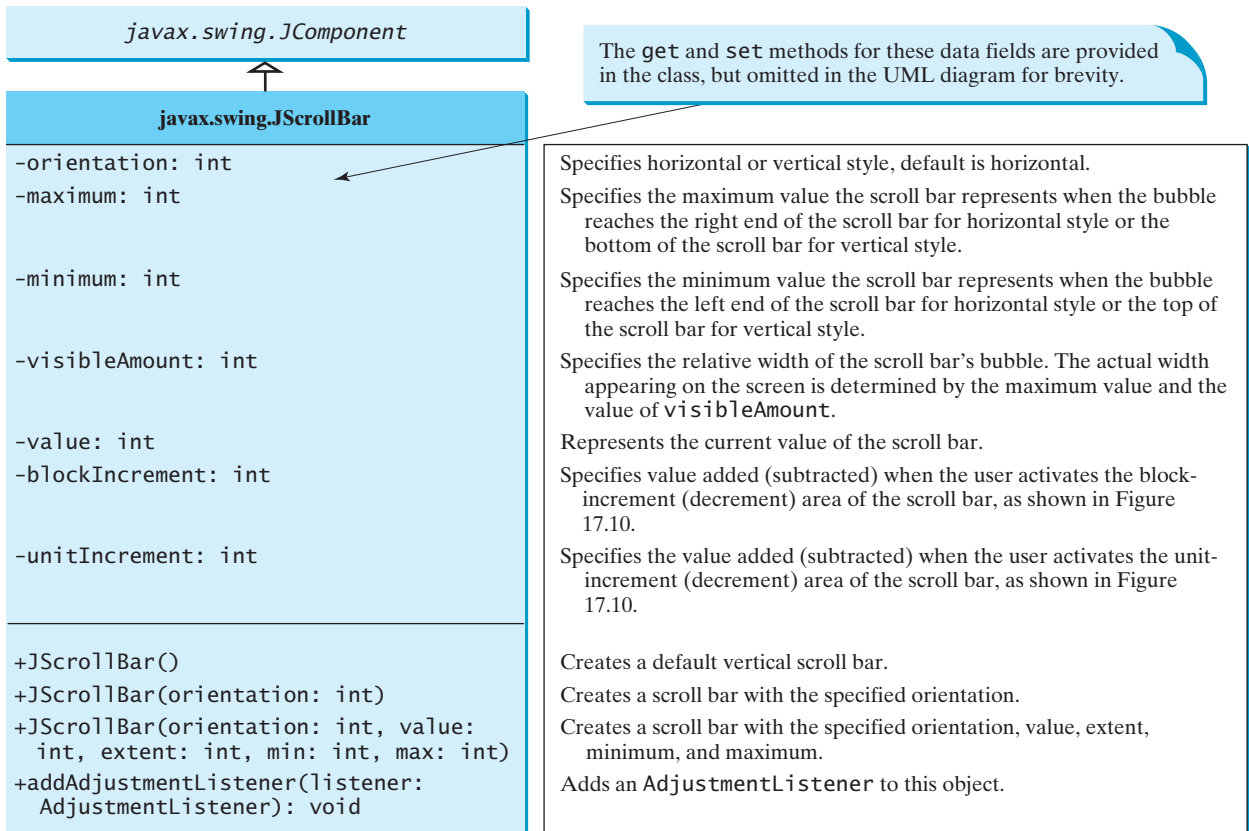


FIGURE 17.11 `JScrollBar` enables you to select from a range of values.



FIGURE 17.12 The scroll bars move the message on a panel horizontally and vertically.

2. Process the event.
Create listeners to implement the `adjustmentValueChanged` handler to move the message according to the bar movement in the scroll bars.

LISTING 17.6 `ScrollBarDemo.java`

```

1  import java.awt.*;
2  import java.awt.event.*;
3  import javax.swing.*;
4
5  public class ScrollBarDemo extends JFrame {
6      // Create horizontal and vertical scroll bars
7      private JScrollBar jschHort =

```

horizontal scroll bar

```

8         new JScrollbar(JScrollbar.HORIZONTAL);
vertical scroll bar 9     private JScrollbar jscbVert =
10        new JScrollbar(JScrollbar.VERTICAL);
11
12        // Create a MessagePanel
13     private MessagePanel messagePanel =
14        new MessagePanel("Welcome to Java");
15
16     public static void main(String[] args) {
create frame 17         ScrollBarDemo frame = new ScrollBarDemo();
18         frame.setTitle("ScrollBarDemo");
19         frame.setLocationRelativeTo(null); // Center the frame
20         frame.setDefaultCloseOperation(JFrame.EXIT_ON_CLOSE);
21         frame.pack();
22         frame.setVisible(true);
23     }
24
25     public ScrollBarDemo() {
create UI 26         // Add scroll bars and message panel to the frame
27         setLayout(new BorderLayout());
add scroll bar 28         add(messagePanel, BorderLayout.CENTER);
29         add(jscbVert, BorderLayout.EAST);
30         add(jscbHort, BorderLayout.SOUTH);
31
32         // Register listener for the scroll bars
adjustment listener 33         jscbHort.addAdjustmentListener(new AdjustmentListener() {
34             @Override
35             public void adjustmentValueChanged(AdjustmentEvent e) {
36                 // getValue() and getMaximumValue() return int, but for better
37                 // precision, use double
38                 double value = jscbHort.getValue();
39                 double maximumValue = jscbHort.getMaximum();
40                 double newX = (value * messagePanel.getWidth() /
41                     maximumValue);
42                 messagePanel.setXCoordinate((int)newX);
43             }
44         });
adjustment listener 45         jscbVert.addAdjustmentListener(new AdjustmentListener() {
46             @Override
47             public void adjustmentValueChanged(AdjustmentEvent e) {
48                 // getValue() and getMaximum() return int, but for better
49                 // precision, use double
50                 double value = jscbVert.getValue();
51                 double maximumValue = jscbVert.getMaximum();
52                 double newY = (value * messagePanel.getHeight() /
53                     maximumValue);
54                 messagePanel.setYCoordinate((int)newY);
55             }
56         });
57     }
58 }

```

The program creates two scroll bars (`jscbVert` and `jscbHort`) (lines 7–10) and an instance of `MessagePanel` (`messagePanel`) (lines 13–14). `messagePanel` is placed in the center of the frame (line 28); `jscbVert` and `jscbHort` are placed in the east and south sections of the frame (lines 29–30), respectively.

You can specify the orientation of the scroll bar in the constructor or use the `setOrientation` method. By default, the property value is `100` for `maximum`, `0` for `minimum`, `10` for `blockIncrement`, and `10` for `visibleAmount`.

When the user drags the bubble, or clicks the increment or decrement unit, the value of the scroll bar changes. An instance of `AdjustmentEvent` is fired and passed to the listener by invoking the `adjustmentValueChanged` handler. The listener for the vertical scroll bar moves the message up and down (lines 33–44), and the listener for the horizontal bar moves the message to the right and left (lines 45–56).

The maximum value of the vertical scroll bar corresponds to the height of the panel, and the maximum value of the horizontal scroll bar corresponds to the width of the panel. The ratio between the current and maximum values of the horizontal scroll bar is the same as the ratio between the `x` value and the width of the message panel. Similarly, the ratio between the current and maximum values of the vertical scroll bar is the same as the ratio between the `y` value and the height of the message panel. The `x`-coordinate and `y`-coordinate are set in response to the scroll bar adjustments (lines 39, 50).

- 17.17** How do you create a horizontal scroll bar? How do you create a vertical scroll bar?
- 17.18** What event can a scroll bar fire when the user changes the value on a scroll bar? What is the corresponding interface for the event? What is the handler defined in the interface?
- 17.19** How do you get the value from a scroll bar? How do you get the maximum value from a scroll bar?



MyProgrammingLab™

17.7 Sliders

`JSlider` is similar to `JScrollBar`, but `JSlider` has more properties and can appear in many forms.



Figure 17.13 shows two sliders. `JSlider` lets the user graphically select a value by sliding a knob within a bounded interval. The slider can show both major tick marks and minor tick marks between them. The number of pixels between the tick marks is controlled by the `majorTickSpacing` and `minorTickSpacing` properties. Sliders can be displayed horizontally and/or vertically, with or without ticks, and with or without labels.

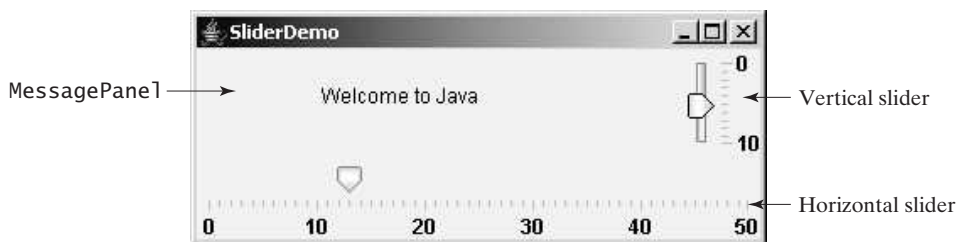


FIGURE 17.13 The sliders move the message on a panel horizontally and vertically.

The frequently used constructors and properties in `JSlider` are shown in Figure 17.14.



Note

The values of a vertical scroll bar increase from top to bottom, but the values of a vertical slider decrease from top to bottom by default.



Note

All the properties listed in Figure 17.14 have the associated `get` and `set` methods, but they are omitted for brevity. By convention, the `get` method for a Boolean property is named `is<PropertyName>()`. In the `JSlider` class, the `get` methods for

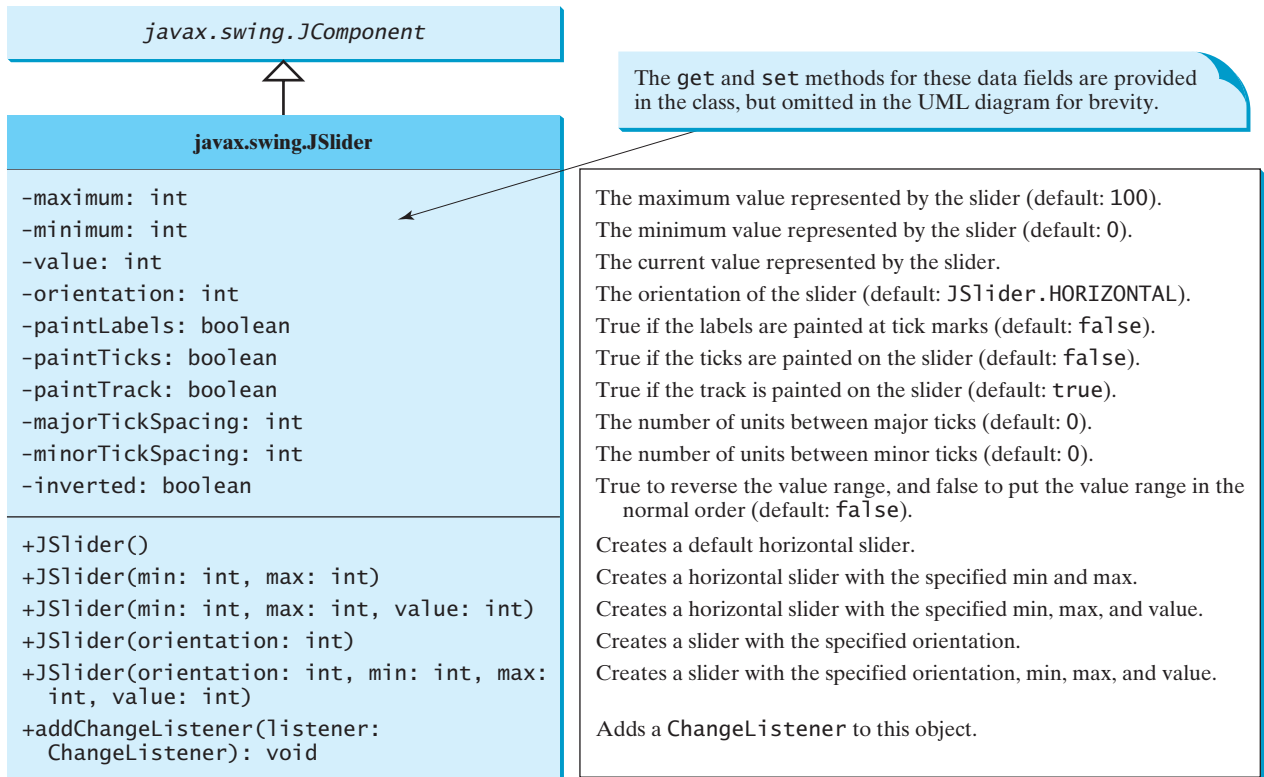


FIGURE 17.14 `JSlider` enables you to select from a range of values.

`paintLabels`, `paintTicks`, `paintTrack`, and `inverted` are `getPaintLabels()`, `getPaintTicks()`, `getPaintTrack()`, and `getInverted()`, which violate the naming convention.

When the user changes the value of the slider, the slider fires an instance of `javax.swing.event.ChangeEvent`, which is passed to any registered listeners. Any object that should be notified of changes to the slider's value must implement the `stateChanged` method in the `ChangeListener` interface defined in the package `javax.swing.event`.

The program in Listing 17.7 uses the sliders to control a message displayed on a panel, as shown in Figure 17.14. Here are the major steps in the program:

1. Create the user interface.
 Create a `MessagePanel` object and place it in the center of the frame. Create a vertical slider and place it in the east of the frame. Create a horizontal slider and place it in the south of the frame.
2. Process the event.
 Create listeners to implement the `stateChanged` handler in the `ChangeListener` interface to move the message according to the knot movement in the slider.

LISTING 17.7 `SliderDemo.java`

```

1 import java.awt.*;
2 import javax.swing.*;
3 import javax.swing.event.*;

```

```

4
5 public class SliderDemo extends JFrame {
6     // Create horizontal and vertical sliders
7     private JSlider jsldHort = new JSlider(JSlider.HORIZONTAL);           horizontal slider
8     private JSlider jsldVert = new JSlider(JSlider.VERTICAL);           vertical slider
9
10    // Create a MessagePanel
11    private MessagePanel messagePanel =
12        new MessagePanel("Welcome to Java");
13
14    public static void main(String[] args) {
15        SliderDemo frame = new SliderDemo();                             create frame
16        frame.setTitle("SliderDemo");
17        frame.setLocationRelativeTo(null); // Center the frame
18        frame.setDefaultCloseOperation(JFrame.EXIT_ON_CLOSE);
19        frame.pack();
20        frame.setVisible(true);
21    }
22
23    public SliderDemo() {                                               create UI
24        // Add sliders and message panel to the frame
25        setLayout(new BorderLayout(5, 5));
26        add(messagePanel, BorderLayout.CENTER);
27        add(jsldVert, BorderLayout.EAST);
28        add(jsldHort, BorderLayout.SOUTH);
29
30        // Set properties for sliders
31        jsldHort.setMaximum(50);                                         slider properties
32        jsldHort.setPaintLabels(true);
33        jsldHort.setPaintTicks(true);
34        jsldHort.setMajorTickSpacing(10);
35        jsldHort.setMinorTickSpacing(1);
36        jsldHort.setPaintTrack(false);
37        jsldVert.setInverted(true);
38        jsldVert.setMaximum(10);
39        jsldVert.setPaintLabels(true);
40        jsldVert.setPaintTicks(true);
41        jsldVert.setMajorTickSpacing(10);
42        jsldVert.setMinorTickSpacing(1);
43
44        // Register listener for the sliders
45        jsldHort.addChangeListener(new ChangeListener() {               listener
46            @Override /** Handle scroll-bar adjustment actions */
47            public void stateChanged(ChangeEvent e) {
48                // getValue() and getMaximumValue() return int, but for better
49                // precision, use double
50                double value = jsldHort.getValue();
51                double maximumValue = jsldHort.getMaximum();
52                double newX = (value * messagePanel.getWidth() /
53                    maximumValue);
54                messagePanel.setXCoordinate((int)newX);
55            }
56        });
57        jsldVert.addChangeListener(new ChangeListener() {               listener
58            @Override /** Handle scroll-bar adjustment actions */
59            public void stateChanged(ChangeEvent e) {
60                // getValue() and getMaximumValue() return int, but for better
61                // precision, use double
62                double value = jsldVert.getValue();
63                double maximumValue = jsldVert.getMaximum();

```

```

64         double newY = (value * messagePanel.getHeight() /
65             maximumValue);
66         messagePanel.setYCoordinate((int)newY);
67     }
68 });
69 }
70 }

```

JSlider is similar to **JScrollBar** but has more features. As shown in this example, you can specify maximum, labels, major ticks, and minor ticks on a **JSlider** (lines 31–35). You can also choose to hide the track (line 36). Since the default values of a vertical slider decrease from top to bottom, the **setInverted** method reverses the order (line 37).

JSlider fires **ChangeEvent** when the slider is changed. The listener needs to implement the **stateChanged** handler in **ChangeListener** (lines 45–68). Note that **JScrollBar** fires **AdjustmentEvent** when the scroll bar is adjusted.



MyProgrammingLab™

17.20 How do you create a horizontal slider? How do you create a vertical slider?

17.21 What event can a slider fire when the user changes the value on a slider? What is the corresponding interface for the event? What is the handler defined in the interface?

17.22 How do you get the value from a slider? How do you get the maximum value from a slider?

17.8 Creating Multiple Windows



Multiple windows can be created in one program.

Occasionally, you may want to create multiple windows in an application so that the application can open a new window to perform a specified task. The new windows are called *subwindows*, and the main frame is called the *main window*.

Listing 17.8 gives a program that creates a main window with a text area in the scroll pane and a button named *Show Histogram*. When the user clicks the button, a new window appears that displays a histogram to show the occurrences of the letters in the text area. Figure 17.15 contains a sample run of the program.

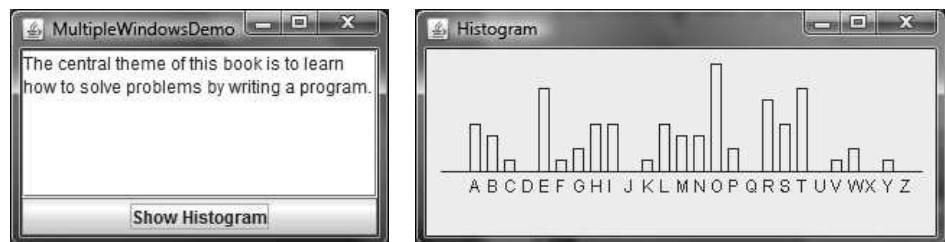


FIGURE 17.15 The histogram is displayed in a separate frame.

Here are the major steps in the program:

1. Define a main class for the frame named **MultipleWindowsDemo** in Listing 17.8. Add a text area inside a scroll pane, and place the scroll pane in the center of the frame. Create a button *Show Histogram* and place it in the south of the frame.
2. Define a subclass of **JPanel** named **Histogram** in Listing 17.9. The class contains a data field named **count** of the **int[]** type, which counts the occurrences of **26** letters. The values in **count** are displayed in the histogram.

3. Implement the `actionPerformed` handler in `MultipleWindowsDemo`, as follows:
 - a. Create an instance of `Histogram`. Count the letters in the text area and set the count in the `Histogram` object.
 - b. Create a new frame and place the `Histogram` object in the center of frame. Display the frame.

LISTING 17.8 MultipleWindowsDemo.java

```

1  import java.awt.*;
2  import java.awt.event.*;
3  import javax.swing.*;
4
5  public class MultipleWindowsDemo extends JFrame {
6      private JTextArea jta;
7      private JButton jbtShowHistogram = new JButton("Show Histogram");
8      private Histogram histogram = new Histogram();
9
10     // Create a new frame to hold the histogram panel
11     private JFrame histogramFrame = new JFrame();           create subframe
12
13     public MultipleWindowsDemo() {                          create UI
14         // Store text area in a scroll pane
15         JScrollPane scrollPane = new JScrollPane(jta = new JTextArea());
16         scrollPane.setPreferredSize(new Dimension(300, 200));
17         jta.setWrapStyleWord(true);
18         jta.setLineWrap(true);
19
20         // Place scroll pane and button in the frame
21         add(scrollPane, BorderLayout.CENTER);
22         add(jbtShowHistogram, BorderLayout.SOUTH);
23
24         // Register listener
25         jbtShowHistogram.addActionListener(new ActionListener() {
26             @Override /** Handle the button action */
27             public void actionPerformed(ActionEvent e) {
28                 // Count the letters in the text area
29                 int[] count = countLetters();
30
31                 // Set the letter count to histogram for display
32                 histogram.showHistogram(count);
33
34                 // Show the frame
35                 histogramFrame.setVisible(true);           display subframe
36             }
37         });
38
39         // Add the histogram panel to the frame
40         histogramFrame.add(histogram);
41         histogramFrame.pack();
42         histogramFrame.setTitle("Histogram");
43     }
44
45     /** Count the letters in the text area */
46     private int[] countLetters() {
47         // Count for 26 letters
48         int[] count = new int[26];
49
50         // Get contents from the text area

```

```

51     String text = jta.getText();
52
53     // Count occurrences of each letter (case insensitive)
54     for (int i = 0; i < text.length(); i++) {
55         char character = text.charAt(i);
56
57         if (character >= 'A' && character <= 'Z') {
58             count[character - 'A']++;
59         }
60         else if (character >= 'a' && character <= 'z') {
61             count[character - 'a']++;
62         }
63     }
64
65     return count; // Return the count array
66 }
67
68 public static void main(String[] args) {
69     MultipleWindowsDemo frame = new MultipleWindowsDemo();
70     frame.setLocationRelativeTo(null); // Center the frame
71     frame.setDefaultCloseOperation(JFrame.EXIT_ON_CLOSE);
72     frame.setTitle("MultipleWindowsDemo");
73     frame.pack();
74     frame.setVisible(true);
75 }
76 }

```

create main frame

LISTING 17.9 Histogram.java

```

1  import javax.swing.*;
2  import java.awt.*;
3
4  public class Histogram extends JPanel {
5      // Count the occurrences of 26 letters
6      private int[] count;
7
8      /** Set the count and display histogram */
9      public void showHistogram(int[] count) {
10         this.count = count;
11         repaint();
12     }
13
14     @Override /** Paint the histogram */
15     protected void paintComponent(Graphics g) {
16         if (count == null) return; // No display if count is null
17
18         super.paintComponent(g);
19
20         // Find the panel size and bar width and interval dynamically
21         int width = getWidth();
22         int height = getHeight();
23         int interval = (width - 40) / count.length;
24         int individualWidth = (int)((width - 40) / 24) * 0.60;
25
26         // Find the maximum count. The maximum count has the highest bar
27         int maxCount = 0;
28         for (int i = 0; i < count.length; i++) {
29             if (maxCount < count[i])
30                 maxCount = count[i];
31         }

```

paint histogram

```

32
33 // x is the start position for the first bar in the histogram
34 int x = 30;
35
36 // Draw a horizontal base line
37 g.drawLine(10, height - 45, width - 10, height - 45);
38 for (int i = 0; i < count.length; i++) {
39     // Find the bar height
40     int barHeight =
41         (int)(((double)count[i] / (double)maxCount) * (height - 55));
42
43     // Display a bar (i.e., rectangle)
44     g.drawRect(x, height - 45 - barHeight, individualWidth,
45         barHeight);
46
47     // Display a letter under the base line
48     g.drawString((char)(65 + i) + "", x, height - 30);
49
50     // Move x for displaying the next character
51     x += interval;
52 }
53 }
54
55 @Override
56 public Dimension getPreferredSize() {
57     return new Dimension(300, 300);
58 }
59 }

```

preferredSize

The program contains two classes: `MultipleWindowsDemo` and `Histogram`. Their relationship is shown in Figure 17.16.

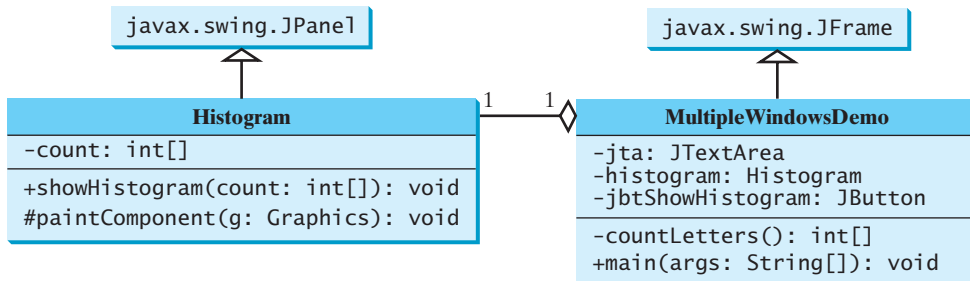


FIGURE 17.16 `MultipleWindowsDemo` uses `Histogram` to display a histogram of the occurrences of the letters in a text area in the frame.

`MultipleWindowsDemo` is a frame that holds a text area in a scroll pane and a button. `Histogram` is a subclass of `JPanel` that displays a histogram for the occurrences of letters in the text area.

In Listing 17.8, `MultipleWindowsDemo.java`, when the user clicks the *Show Histogram* button, the handler counts the occurrences of letters in the text area (line 29). Letters are counted regardless of their case. Nonletter characters are not counted. The count is stored in an `int` array of 26 elements (line 48). The first element in the array stores the count for the letter `a` or `A`, and the last element stores the count for the letter `z` or `Z` (lines 57–63). The `count` array is passed to the histogram for display (line 32).

The `MultipleWindowsDemo` class contains a `main` method. The `main` method creates an instance of `MultipleWindowsDemo` and displays the frame (lines 69–74). The

`MultipleWindowsDemo` class also contains an instance of `JFrame`, named `histogramFrame` (line 8), which holds an instance of `Histogram`. When the user clicks the `Show Histogram` button, `histogramFrame` is set as visible to display the histogram (line 35).

The height and width of the bars in the histogram are determined dynamically according to the window size of the histogram.

You cannot add an instance of `JFrame` to a container. For example, adding `histogramFrame` to the main frame would cause a runtime exception. However, you can create a frame instance and set it visible to launch a new window.



MyProgrammingLab™

17.23 Explain how to create and show multiple windows in an application.

CHAPTER SUMMARY

1. You learned how to handle events for `JCheckBox`, `JRadioButton`, and `JTextField`.
2. You learned how to create graphical user interfaces using the Swing GUI components `JTextArea`, `JComboBox`, `JList`, `JScrollBar`, and `JSlider`. You also learned how to handle events on these components.
3. You learned how to launch multiple windows using `JFrame`.

TEST QUESTIONS

Do the test questions for this chapter online at www.cs.armstrong.edu/liang/intro9e/test.html.

MyProgrammingLab™

PROGRAMMING EXERCISES

Sections 17.2–17.5

- *17.1** (*Use radio buttons*) Write a GUI program as shown in Figure 17.17. You can use buttons to move the message left and right and use the radio buttons to change the background color for the message displayed in the message panel.

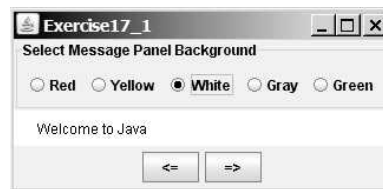


FIGURE 17.17 The `<=` and `=>` buttons move the message on the panel, and the radio buttons change the background color for the message.

- *17.2** (*Select geometric figures*) Write a program that draws various figures, as shown in Figure 17.18. The user selects a figure from a radio button and uses a check box to specify whether it is filled. (*Hint*: Use the `FigurePanel` class introduced in Listing 13.3 to display a figure.)
- **17.3** (*Traffic lights*) Write a program that simulates a traffic light. The program lets the user select one of three lights: red, yellow, or green. When a radio button is selected, the light is turned on, and only one light can be on at a time (see Figure 17.19). No light is on when the program starts.

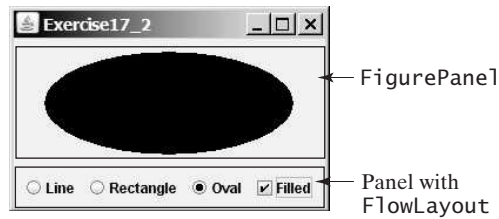


FIGURE 17.18 The program displays lines, rectangles, and ovals when you select a shape type.

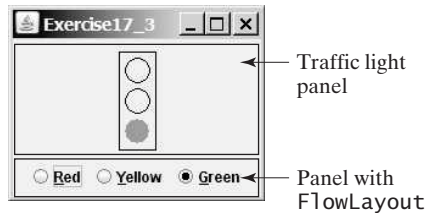


FIGURE 17.19 The radio buttons are grouped to let you select only one color in the group to control a traffic light.

Sections 17.6–17.8

****17.4** (*Text viewer*) Write a program that displays a text file in a text area, as shown in Figure 17.20a. The user enters a file name in a text field and clicks the *View* button; the file is then displayed in a text area.

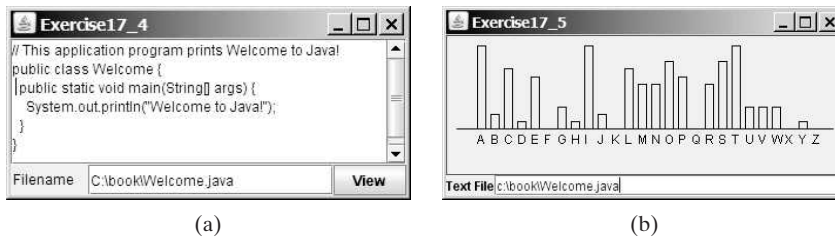


FIGURE 17.20 (a) The program displays the text from a file in a text area. (b) The program displays a histogram that shows the occurrences of each letter in the file.

****17.5** (*Create a histogram for occurrences of letters*) The program in Listing 17.8, `MultipleWindowsDemo.java`, displays a histogram to show the occurrences of each letter in a text area. Reuse the `Histogram` class created in Listing 17.9 to write a program that will display a histogram on a panel. The histogram should show the occurrences of each letter in a text file, as shown in Figure 17.20b. Assume that the letters are not case sensitive.

- Place the panel that will display the histogram in the center of the frame.
- Place a label and a text field in a panel, and put the panel in the south side of the frame. The text file will be entered from this text field.
- Pressing the *Enter* key on the text field causes the program to count the occurrences of each letter and display the count in a histogram.

- *17.6** (*Create a miles/kilometers converter*) Write a program that converts miles and kilometers, as shown in Figure 17.21. If you enter a value in the Mile text field and press the *Enter* key, the corresponding kilometer measurement is displayed in the Kilometer text field. Likewise, if you enter a value in the Kilometer text field and press the *Enter* key, the corresponding miles is displayed in the Mile text field.

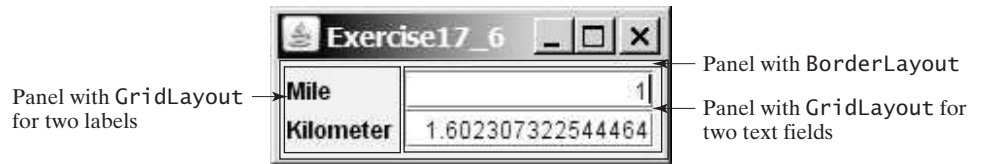


FIGURE 17.21 The program converts miles to kilometers, and vice versa.

- *17.7** (*Set clock time*) Write a program that displays a clock and sets the time with the input from three text fields, as shown in Figure 17.22. Use the `StillClock` in Listing 13.10.

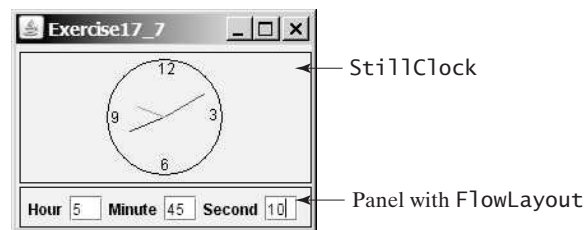


FIGURE 17.22 The program displays the time specified in the text fields.

- **17.8** (*Select a font*) Write a program that can dynamically change the font of a message to be displayed on a panel. The message can be displayed in bold and italic at the same time, and/or it can be displayed in the center of the panel. You can select the font name or font size from combo boxes, as shown in Figure 17.23. The available font names can be obtained using `getAvailableFontFamilyNames()` in `GraphicsEnvironment` (see Section 12.8, The `Font` Class). The combo box for the font size is initialized with numbers from **1** to **100**.



FIGURE 17.23 You can dynamically set the font for the message.

****17.9** (Demonstrate `JLabel` properties) Write a program to let the user dynamically set the properties `horizontalAlignment`, `verticalAlignment`, `horizontalTextAlignment`, and `verticalTextAlignment`, as shown in Figure 17.24.

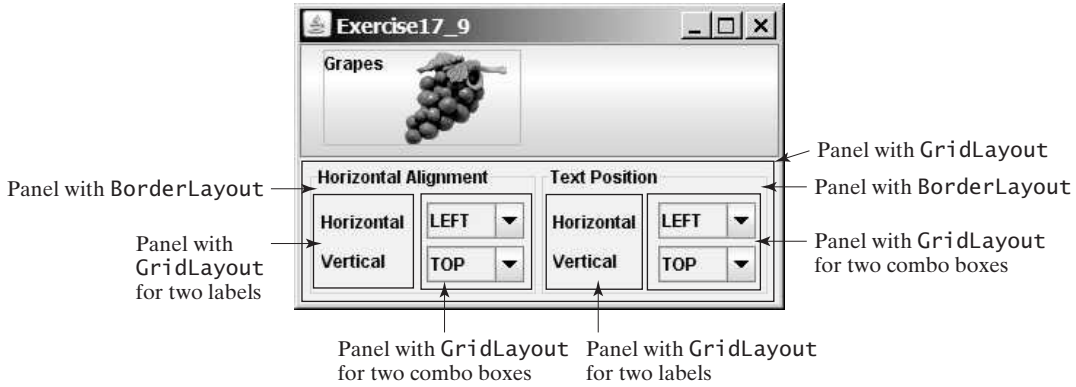
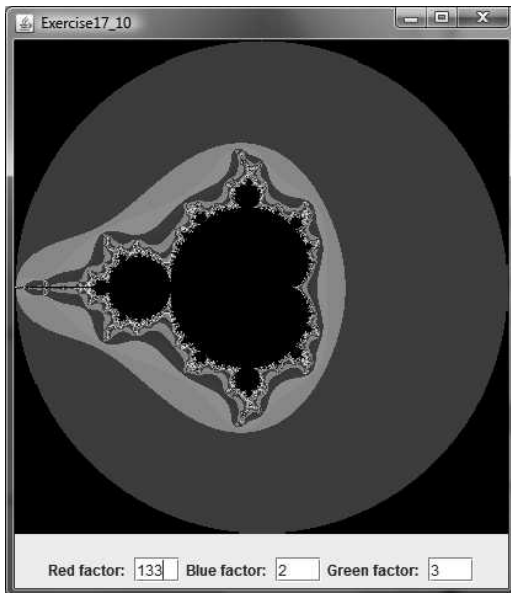
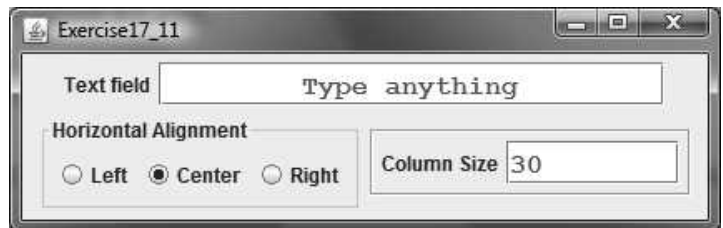


FIGURE 17.24 You can set the alignment and text-position properties of a label dynamically.

***17.10** (*Mandelbrot fractal*) Programming Exercise 15.20 displays Mandelbrot fractal. Note that the values `77`, `58`, and `159` in line 15 in the `MandelbrotCanvas` class in Programming Exercise 15.20 impact the color of the image. Revise the program to let the user enter these values from text fields dynamically, as shown in Figure 17.25a.



(a)



(b)

FIGURE 17.25 (a) The program enables the user to set the colors dynamically. (b) You can set a text field's properties for the horizontal alignment and column size dynamically.



VideoNote

Use text areas

- *17.11 (Demonstrate *JTextField* properties) Write a program that sets the horizontal-alignment and column-size properties of a text field dynamically, as shown in Figure 17.25b.
- *17.12 (Demonstrate *JTextArea* properties) Write a program that demonstrates the wrapping styles of the text area. The program uses a check box to indicate whether the text area is wrapped. If the text area is wrapped, you can specify whether it is wrapped by characters or by words, as shown in Figure 17.26.

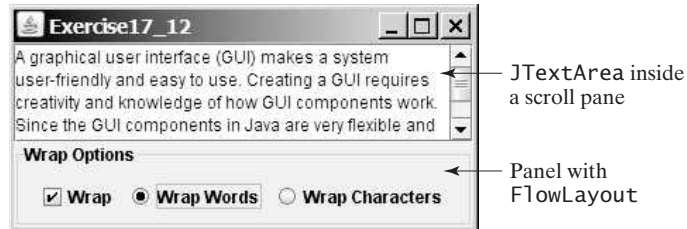


FIGURE 17.26 You can set the options to wrap a text area dynamically by characters or by words.

- *17.13 (Compare loans with various interest rates) Rewrite Programming Exercise 4.21 to create a user interface, as shown in Figure 17.27. Your program should let the user enter the loan amount and loan period in the number of years from a text field, and it should display the monthly and total payments for each interest rate starting from 5 percent to 8 percent, with increments of one-eighth, in a text area.

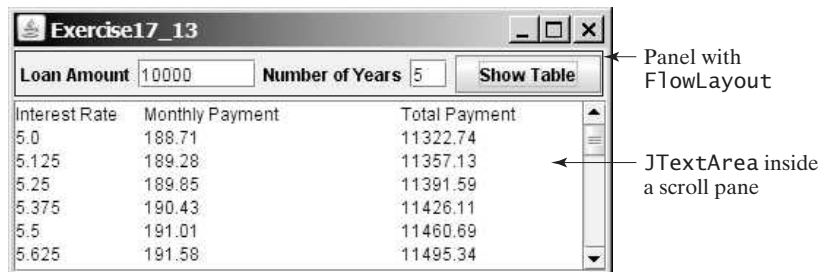


FIGURE 17.27 The program displays a table for monthly payments and total payments on a given loan based on various interest rates.

- *17.14 (Use *JComboBox* and *JList*) Write a program that demonstrates selecting items in a list. The program uses a combo box to specify a selection mode, as shown in Figure 17.28. When you select items, they are displayed in a label below the list.

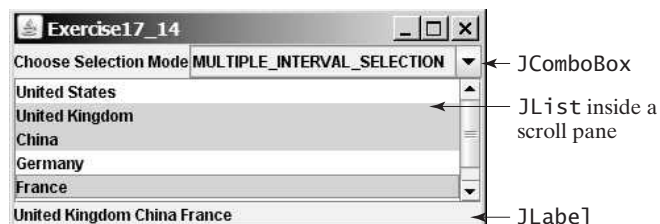


FIGURE 17.28 You can choose single selection, single-interval selection, or multiple-interval selection in a list.

Sections 17.6–17.8

****17.15** (Use *JScrollbar*) Write a program that uses scroll bars to select the foreground color for a label, as shown in Figure 17.29. Three horizontal scroll bars are used for selecting the color’s red, green, and blue components. Use a title border on the panel that holds the scroll bars.

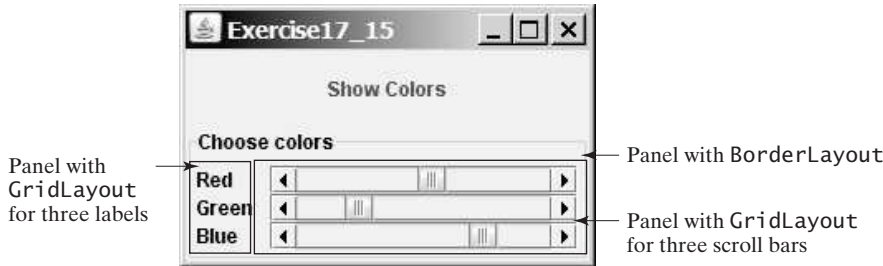


FIGURE 17.29 The foreground color changes in the label as you adjust the scroll bars.

****17.16** (Use *JSlider*) Revise the preceding exercise using sliders.

*****17.17** (Display a calendar) Write a program that displays the calendar for the current month. You can use the *Prior* and *Next* buttons to show the calendar of the previous or next month. Display the dates in the current month in black and display the dates in the previous month and next month in gray, as shown in Figure 17.30.

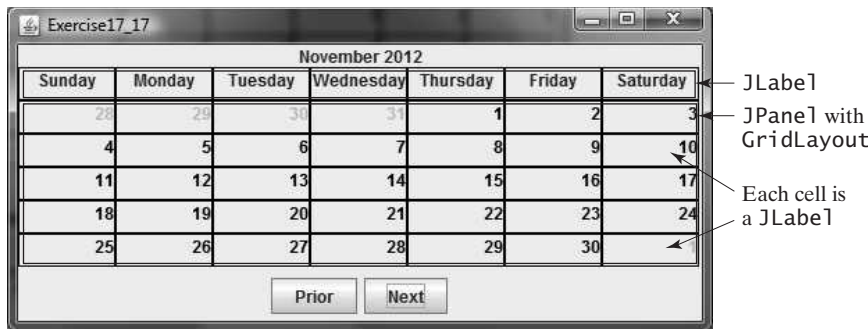


FIGURE 17.30 The program displays the calendar for the current month.

***17.18** (Revise Listing 17.8, *MultipleWindowsDemo.java*) Instead of displaying the occurrences of the letters using the **Histogram** component in Listing 17.8, use a bar chart, so that the display is as shown in Figure 17.31.

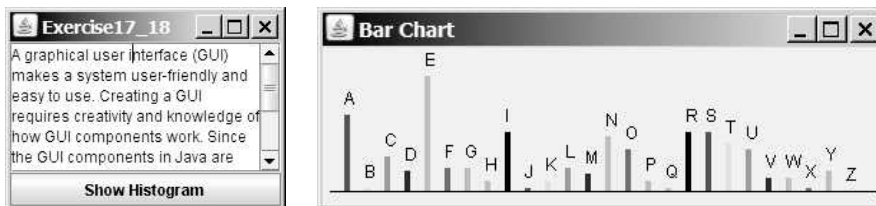


FIGURE 17.31 The number of occurrences of each letter is displayed in a bar chart.

- **17.19** (*Display country flag and flag description*) Listing 17.4, `ComboBoxDemo.java`, gives a program that lets users view a country's flag image and description by selecting the country from a combo box. The description is a string coded in the program. Rewrite the program to read the text description from a file. Suppose that the descriptions are stored in the files **description0.txt**, . . . , and **description8.txt** under the **text** directory for the nine countries Canada, China, Denmark, France, Germany, India, Norway, the United Kingdom, and the United States, in this order.
- **17.20** (*Slide show*) Programming Exercise 16.13 developed a slide show using images. Rewrite that program to develop a slide show using text files. Suppose ten text files named **slide0.txt**, **slide1.txt**, . . . , and **slide9.txt** are stored in the **text** directory. Each slide displays the text from one file. Each slide is shown for one second, and the slides are displayed in order. When the last slide finishes, the first slide is redisplayed, and so on. Use a text area to display the slide.
- **17.21** (*Retrieve files from Web*) Write a Java program that retrieves a file from a Web server, as shown in Figure 17.32. The user interface includes a text field in which to enter the URL of the file name, a text area in which to show the file, and a button that can be used to submit an action. A label is added at the bottom of the applet to indicate the status, such as *File loaded successfully* or *Network connection problem*.

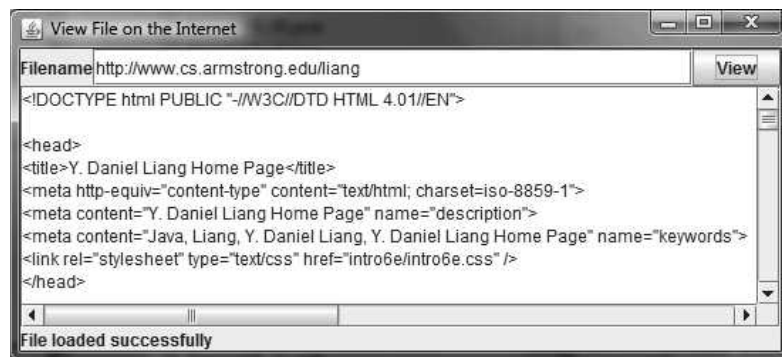


FIGURE 17.32 The program displays the contents of a specified file on the Internet.

APPLETS AND MULTIMEDIA

Objectives

- To convert GUI applications into applets (§18.2).
- To embed applets in Web pages (§18.3).
- To run applets from Web browsers and from the **appletviewer** command (§§18.3.1–18.3.2).
- To understand the applet security sandbox model (§18.4).
- To write a Java program that can run both as an application and as an applet (§18.5).
- To override the applet life-cycle methods **init**, **start**, **stop**, and **destroy** (§18.6).
- To pass string values to applets from HTML (§18.7).
- To develop an animation for a bouncing ball (§18.8).
- To develop an applet for the tic-tac-toe game (§18.9).
- To locate resources (images and audio) using the **URL** class (§18.10).
- To play audio in any Java program (§18.11).



18.1 Introduction



Java applets are Java programs running from a Web browser.

When browsing the Web, often the graphical user interface and animation you see have been developed using Java. The Java programs that run from a Web browser are called *Java applets*. How do you write Java applets with graphics, images, and audio? This chapter will show you how.

18.2 Developing Applets



Java applets are instances of the `Applet` class. `JApplet` is a subclass of `Applet`, and it is suitable for developing applets using Swing components.



VideoNote

First applet

So far, you have used and written Java applications. Everything you have learned about writing applications, however, applies also to writing applets. Applications and applets share many common programming features, although they differ slightly in some aspects. For example, every application must have a `main` method, which is invoked by the Java interpreter. Java applets, on the other hand, do not need a `main` method. They run in the Web browser environment. Because applets are embedded in a Web page, Java provides special features that enable applets to run from a Web browser.

The `Applet` class provides the essential framework that enables applets to be run from a Web browser. While every Java application has a `main` method that is executed when the application starts, applets, because they don't have a `main` method, depend on the browser to run them. Every applet is an instance of `java.applet.Applet`. The `Applet` class is an AWT class and is not designed to work with Swing components. To use Swing components in Java applets, you need to define a Java applet that extends `javax.swing.JApplet`, which is a subclass of `java.applet.Applet`.

Every Java GUI program you have developed can be converted into an applet by replacing `JFrame` with `JApplet` and deleting the `main` method. Figure 18.1a shows a Java GUI application program, which can be converted into a Java applet as shown in Figure 18.1b.

```
import javax.swing.*;

public class DisplayLabel extends JFrame {
    public DisplayLabel() {
        add(new JLabel("Great!", JLabel.CENTER));
    }

    public static void main(String[] args) {
        JFrame frame = new DisplayLabel();
        frame.setTitle("DisplayLabel");
        frame.setSize(200, 100);
        frame.setLocationRelativeTo(null);
        frame.setDefaultCloseOperation(
            JFrame.EXIT_ON_CLOSE);
        frame.setVisible(true);
    }
}
```

(a) GUI application

```
import javax.swing.*;

public class DisplayLabel extends JApplet {
    public DisplayLabel() {
        add(new JLabel("Great!", JLabel.CENTER));
    }

    public static void main(String[] args) {
        JFrame frame = new DisplayLabel();
        frame.setTitle("DisplayLabel");
        frame.setSize(200, 100);
        frame.setLocationRelativeTo(null);
        frame.setDefaultCloseOperation(
            JFrame.EXIT_ON_CLOSE);
        frame.setVisible(true);
    }
}
```

(b) Applet

FIGURE 18.1 You can convert a GUI application into an applet.

Listing 18.1 gives the complete code for the applet.

LISTING 18.1 DisplayLabel.java

```
1 import javax.swing.*;
2
3 public class DisplayLabel extends JApplet {
    extend JApplet
```

```

4 public DisplayLabel() {
5     add(new JLabel("Great!", JLabel.CENTER));
6 }
7 }

```

Like `JFrame`, `JApplet` is a container that can contain other GUI components (see the GUI class diagrams in Figure 12.1). The default layout manager for `JApplet` is `BorderLayout`. So, the label is placed in the center of the applet (line 5).

18.1 Is every applet an instance of `java.applet.Applet`?

18.2 Is `javax.swing.JApplet` a subclass of `java.applet.Applet`?



MyProgrammingLab™

18.3 The HTML File and the `<applet>` Tag

To run an applet, you need to create an HTML file with an `<applet>` tag for embedding the applet.



HTML is a markup language that presents static documents on the Web. It uses *tags* to instruct the Web browser how to render a Web page and contains a tag called `<applet>` that incorporates applets into a Web page.

HTML

The HTML file in Listing 18.2 embeds the applet `DisplayLabel.class`.

LISTING 18.2 DisplayLabel.html

```

<html>
  <head>
    <title>Java Applet Demo</title>
  </head>
  <body>
    <applet
      code = "DisplayLabel.class"
      width = 250
      height = 50>
    </applet>
  </body>
</html>

```

applet class

An HTML *tag* is an instruction to the Web browser. The browser interprets the tag and decides how to display or otherwise treat the subsequent contents of the HTML document. Tags are enclosed inside brackets (`< >`). The first word in a tag, called the *tag name*, describes tag functions. A tag can have additional attributes, sometimes with values after an equals sign, which further define the tag's action. For example, in the preceding HTML file, `<applet>` is the tag name, and `code`, `width`, and `height` are attributes. The `width` and `height` attributes specify the rectangular viewing area of the applet.

tag

Most tags have a *start tag* and a corresponding *end tag*. The tag has a specific effect on the region between the start tag and the end tag. For example, `<applet...>...</applet>` tells the browser to display an applet. An end tag is always the start tag's name preceded by a slash.

An HTML document begins with the `<html>` tag, which declares that the document is written in HTML. Each document has two parts, a *head* and a *body*, defined by `<head>` and `<body>` tags, respectively. The head part contains the document title, including the `<title>` tag and other information the browser can use when rendering the document, and the body part holds the actual contents of the document. The header is optional. For more information, refer to Supplement V.A, HTML and XHTML Tutorial.

<applet> tag

The complete syntax of the `<applet>` tag is as follows:

```

<applet
  [codebase = applet_url]

```

```

code = classfilename.class
width = applet_viewing_width_in_pixels
height = applet_viewing_height_in_pixels
[archive = archivefile]
[vspace = vertical_margin]
[hspace = horizontal_margin]
[align = applet_alignment]
[alt = alternative_text]
>
<param name = param_name1 value = param_value1>
<param name = param_name2 value = param_value2>
...
<param name = param_namei value = param_valuei>
</applet>

```

The `code`, `width`, and `height` attributes are required; all the others are optional. The `<param>` tag will be introduced in Section 18.7, Passing Strings to Applets. The other attributes are explained below.

codebase attribute

- **codebase** specifies the base from which your classes are loaded. If this attribute is not used, the Web browser loads the applet from the directory in which the HTML page is located. If your applet is located in a different directory from the HTML page, you must specify the **applet_url** for the browser to load the applet. This attribute enables you to load the class from anywhere on the Internet. The classes used by the applet are dynamically loaded when needed.

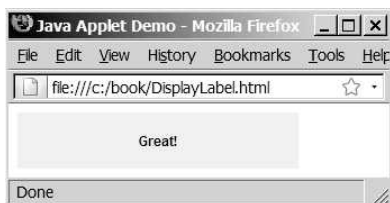
archive attribute

- **archive** instructs the browser to load an archive file that contains all the class files needed to run the applet. Archiving allows the Web browser to load all the classes from a single compressed file at one time, thus reducing loading time and improving performance. To create archives, see Supplement III.Q, Packaging and Deploying Java Projects.
- **vspace** and **hspace** specify the size, in pixels, of the blank margin to pad around the applet vertically and horizontally.
- **align** specifies how the applet will be aligned in the browser. One of nine values is used: **left**, **right**, **top**, **texttop**, **middle**, **absmiddle**, **baseline**, **bottom**, or **absbottom**.
- **alt** specifies the text to be displayed in case the browser cannot run Java.

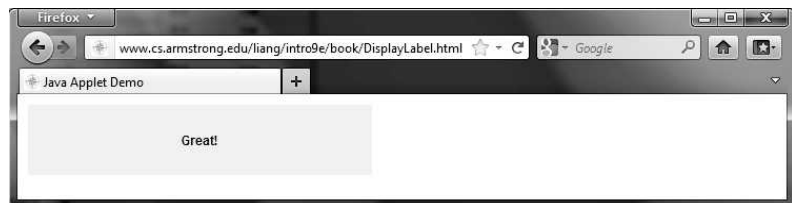
18.3.1 Viewing Applets from a Web Browser

To display an applet from a Web browser, open the applet's HTML file (e.g., **DisplayLabel.html**). Its output is shown in Figure 18.2a.

To make your applet accessible on the Web, you need to store the **DisplayLabel.class** and **DisplayLabel.html** files on a Web server, as shown in Figure 18.3. You can view the applet



(a)



(b)

FIGURE 18.2 The DisplayLabel program is loaded from a local host in (a) and from a Web server in (b).

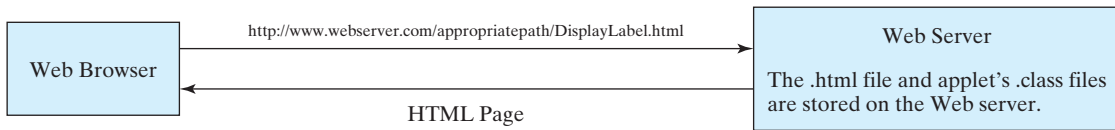


FIGURE 18.3 A Web browser requests an HTML file from a Web server.

from an appropriate URL. For example, I have uploaded these two files on Web server www.cs.armstrong.edu/. As shown in Figure 18.2b, you can access the applet from www.cs.armstrong.edu/liang/intro9e/book/DisplayLabel.html.

18.3.2 Viewing Applets Using the Applet Viewer Utility

You can test the applet using the applet viewer utility, which can be launched from the DOS prompt using the **appletviewer** command, as shown in Figure 18.4a. Its output is shown in Figure 18.4b.

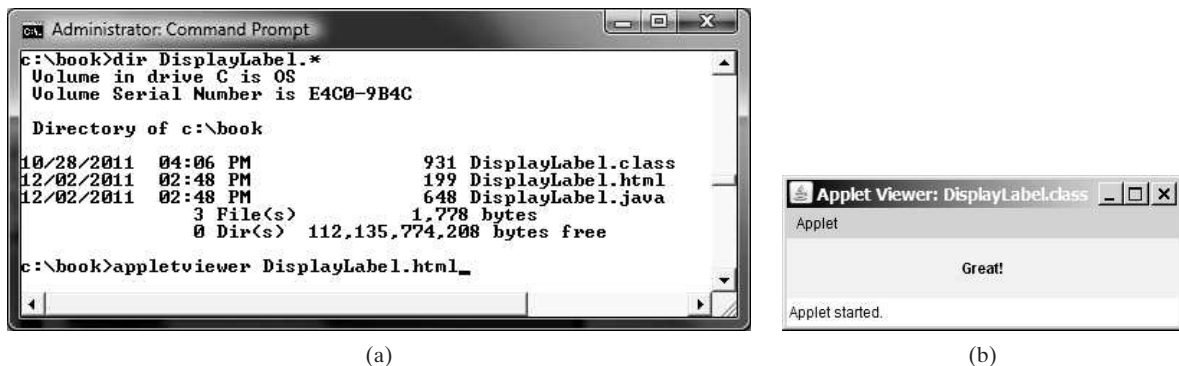


FIGURE 18.4 The **appletviewer** command runs a Java applet in the applet viewer utility.

The applet viewer functions as a browser. It is convenient for testing applets during development without launching a Web browser.

- 18.3** Describe the `<applet>` HTML tag. How do you embed an applet in a web page?
- 18.4** How do you test an applet using the **appletviewer** command?



MyProgrammingLab™

18.4 Applet Security Restrictions

Applet security restrictions ensure that safety is maintained when running applets.

Java uses the so-called “sandbox security model” for executing applets to prevent destructive programs from damaging the system on which the browser is running. Applets are not allowed to use resources outside the “sandbox.” Specifically, the sandbox restricts the following activities:

- Applets are not allowed to read from, or write to, the file system of the computer. Otherwise, they could damage the files and spread viruses.
- Applets are not allowed to run programs on the browser’s computer. Otherwise, they might call destructive local programs and damage the local system on the user’s computer.
- Applets are not allowed to establish connections between the user’s computer and any other computer, except for the server where the applets are stored. This restriction prevents the applet from connecting the user’s computer to another computer without the user’s knowledge.



signed applet

**Note**

You can create *signed applets* to circumvent the security restrictions. See Supplement III.S, Signed Applets, for detailed instructions on how to create signed applets.



18.5 List some security restrictions on applets.

MyProgrammingLab™



18.5 Enabling Applets to Run as Applications

You can add a main method in the applet to enable the applet to run as a standalone application.



VideoNote

Run applets standalone

Despite some differences, the **JFrame** class and the **JApplet** class have a lot in common. Since they both are subclasses of the **Container** class, all their user-interface components, layout managers, and event-handling features are the same. Applications, however, are invoked from the static **main** method by the Java interpreter, and applets are run by the Web browser. The Web browser creates an instance of the applet using the applet's no-arg constructor and controls and executes the applet.

In general, an applet can be converted into an application without loss of functionality. An application can be converted into an applet as long as it does not violate the security restrictions imposed on applets. You can implement a **main** method in an applet to enable the applet to run as an application. This feature has both theoretical and practical implications. Theoretically, it blurs the difference between applets and applications: You can write a class that is both an applet and an application. From the standpoint of practicality, it is convenient to be able to run a program both ways.

How do you write such programs? Suppose you have an applet named **MyApplet**. To enable it to run as an application, you only need to add a **main** method in the applet, as follows:

```

public static void main(String[] args) {
    // Create a frame
    JFrame frame = new JFrame("Applet is in the frame");

    // Create an instance of the applet
    MyApplet applet = new MyApplet();

    // Add the applet to the frame
    frame.add(applet, BorderLayout.CENTER);

    // Display the frame
    frame.setSize(300, 300);
    frame.setLocationRelativeTo(null); // Center the frame
    frame.setDefaultCloseOperation(JFrame.EXIT_ON_CLOSE);
    frame.setVisible(true);
}

```

create frame

create applet

add applet

show frame

run standalone

You can revise the **DisplayLabel** class in Listing 18.1 to enable it to run as a standalone application (often abbreviated as “run standalone”) by adding a **main** method, as shown in Listing 18.3.

LISTING 18.3 New DisplayLabel.java with a main Method

```

1 import javax.swing.*;
2
3 public class DisplayLabel extends JApplet {
4     public DisplayLabel() {
5         add(new JLabel("Great!", JLabel.CENTER));
6     }
7

```



```

8  public static void main(String[] args) {
9      // Create a frame
10     JFrame frame = new JFrame("Applet is in the frame");
11
12     // Create an instance of the applet
13     DisplayLabel applet = new DisplayLabel();
14
15     // Add the applet to the frame
16     frame.add(applet);
17
18     // Display the frame
19     frame.setSize(300, 100);
20     frame.setLocationRelativeTo(null); // Center the frame
21     frame.setDefaultCloseOperation(JFrame.EXIT_ON_CLOSE);
22     frame.setVisible(true);
23 }
24 }

```

new main method

When the applet is run from a Web browser, the browser creates an instance of the applet and displays it. When the applet is run standalone, the main method is invoked to create a frame (line 10) to hold the applet. The applet is created (line 13) and added to the frame (line 16). The frame is displayed in line 22.

Note that you can add an applet to a container, but not a frame to a container. A frame is a top-level container that cannot be embedded in another container.

- 18.6** How do you add components to a **JApplet**? What is the default layout manager of **JApplet**?
- 18.7** Can you place a frame in an applet?
- 18.8** Can you place an applet in a frame?
- 18.9** What are the differences between applications and applets? How do you run an application, and how do you run an applet? Is the compilation process different for applications and applets?



MyProgrammingLab™

18.6 Applet Life-Cycle Methods

The Web browser controls and executes applets using the applet life-cycle methods.

Applets are actually run from the *applet container*, which is a plug-in of a Web browser. A plug-in is a software component that can be added into a larger software to provide additional functions. The **Applet** class contains the **init()**, **start()**, **stop()**, and **destroy()** methods, known as the *life-cycle methods*. These methods are called by the applet container to control the execution of an applet. They are implemented with an empty body in the **Applet** class, so they do nothing by default. You may override them in a subclass of **Applet** to perform desired operations. Figure 18.5 shows how the applet container calls these methods.



applet container

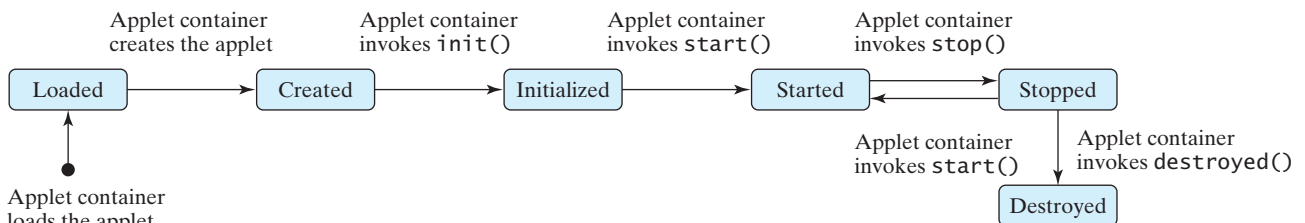


FIGURE 18.5 The applet container uses the **init**, **start**, **stop**, and **destroy** methods to control the applet.

18.6.1 The `init` Method

`init()`

The `init` method is invoked after the applet is created. If a subclass of `Applet` has an initialization to perform, it should override this method. The functions usually implemented in this method include getting string parameter values from the `<applet>` tag in the HTML page.

18.6.2 The `start` Method

`start()`

The `start` method is invoked after the `init` method. It is also called when the user returns to the Web page containing the applet after surfing other pages.

A subclass of `Applet` overrides this method if it has any operation that needs to be performed whenever the Web page containing the applet is visited. An applet with animation, for example, might start the timer to resume animation.

18.6.3 The `stop` Method

`stop()`

The `stop` method is the opposite of the `start` method. The `start` method is called when the user moves back to the page that contains the applet. The `stop` method is invoked when the user leaves the page.

A subclass of `Applet` overrides this method if it has any operation to be performed each time the Web page containing the applet is no longer visible. An applet with animation, for example, might stop the timer to pause animation.

18.6.4 The `destroy` Method

`destroy()`

The `destroy` method is invoked when the browser exits normally to inform the applet that it is no longer needed and should release any resources it has allocated. The `stop` method is always called before the `destroy` method.

A subclass of `Applet` overrides this method if it has any operation to be performed before it is destroyed. Usually, you won't need to override this method unless you want to release specific resources that the applet created.



18.10 Describe the `init()`, `start()`, `stop()`, and `destroy()` methods in the `Applet` class.

MyProgrammingLab™

18.11 Why does the applet in (a) below display nothing? Why does the applet in (b) have a runtime `NullPointerException` on the highlighted line?

```
import javax.swing.*;

public class WelcomeApplet extends JApplet {
    public void WelcomeApplet() {
        JLabel jLabel1Message =
            new JLabel("It is Java");
    }
}
```

(a)

```
import javax.swing.*;

public class WelcomeApplet extends JApplet {
    private JLabel jLabel1Message;

    public WelcomeApplet() {
        JLabel jLabel1Message =
            new JLabel("It is Java");
    }

    @Override
    public void init() {
        add(jLabel1Message);
    }
}
```

(b)

18.7 Passing Strings to Applets

You can pass string parameters from an HTML file to an applet.



In Section 9.7, Command-Line Arguments, you learned how to pass strings to Java applications from a command line. Strings are passed to the `main` method as an array of strings. When the application starts, the `main` method can use these strings. There is no `main` method in an applet, however, and applets are not run from the command line by the Java interpreter.

How, then, can applets accept arguments? In this section, you will learn how to pass strings to Java applets. To be passed to an applet, a parameter must be defined in the HTML file and must be read by the applet when it is initialized. Parameters are defined using the `<param>` tag. The `<param>` tag must be embedded in the `<applet>` tag. Its syntax is:

```
<param name = parametername value = stringvalue />
```

The `<param>` tag defines a parameter and its corresponding string value.



Note

No comma separates the parameter name from the parameter value in the HTML code. The HTML parameter names are not case sensitive.

Suppose you want to write an applet to display a message. The message is passed as a parameter. In addition, you want the message to be displayed at a specific location with *x*-coordinate and *y*-coordinate, which are passed as two parameters. The parameters and their values are listed in Table 18.1.

TABLE 18.1 Parameter Names and Values for the `DisplayMessage` Applet

Parameter Name	Parameter Value
MESSAGE	"Welcome to Java"
X	20
Y	30

The HTML source file is given in Listing 18.4.

LISTING 18.4 `DisplayMessage.html`

```
<html>
<head>
  <title>Passing Strings to Java Applets</title>
</head>
<body>
  <p>This applet gets a message from the HTML
    page and displays it.</p>
  <applet
    code = "DisplayMessage.class"
    width = 200
    height = 50
    alt = "You must have a Java-enabled browser to view the applet"
  >
    <param name = MESSAGE value = "Welcome to Java" />
    <param name = X value = 20 />
```

```

        <param name = Y value = 30 />
    </applet>
</body>
</html>

```

To read the parameter from the applet, use the following method defined in the `Applet` class:

```
public String getParameter(String parametername);
```

This returns the value of the specified parameter.

The applet is given in Listing 18.5. A sample run of the applet is shown in Figure 18.6.

LISTING 18.5 DisplayMessage.java

```

1  import javax.swing.*;
2
3  public class DisplayMessage extends JApplet {
4      @Override /** Initialize the applet */
5      public void init() {
6          // Get parameter values from the HTML file
7          String message = getParameter("MESSAGE");
8          int x = Integer.parseInt(getParameter("X"));
9          int y = Integer.parseInt(getParameter("Y"));
10
11         // Create a message panel
12         MessagePanel messagePanel = new MessagePanel(message);
13         messagePanel.setXCoordinate(x);
14         messagePanel.setYCoordinate(y);
15
16         // Add the message panel to the applet
17         add(messagePanel);
18     }
19 }

```

getParameter

add to applet



FIGURE 18.6 The applet displays the message `Welcome to Java` passed from the HTML page.

The program gets the parameter values from the HTML file in the `init` method. The values are strings obtained using the `getParameter` method (lines 7–9). Because `x` and `y` are `ints`, the program uses `Integer.parseInt(string)` to parse a digital string into an `int` value.

If you change `Welcome to Java` in the HTML file to `Welcome to HTML`, and reload the HTML file in the Web browser, you should see `Welcome to HTML` displayed. Similarly, the `x` and `y` values can be changed to display the message in a desired location.



Caution

The `Applet`'s `getParameter` method can be invoked only after an instance of the applet is created. Therefore, this method cannot be invoked in the constructor of the applet class. You should invoke it from the `init` method.

You can add a main method to enable this applet to run as a standalone application. The applet takes the parameters from the HTML file when it runs as an applet and takes the parameters from the command line when it runs standalone. The program, as shown in Listing 18.6, is identical to `DisplayMessage` except for the addition of a new `main` method and of a variable named `isStandalone` to indicate whether it is running as an applet or as an application.

LISTING 18.6 `DisplayMessageApp.java`

```

1  import javax.swing.*;
2  import java.awt.Font;
3  import java.awt.BorderLayout;
4
5  public class DisplayMessageApp extends JApplet {
6      private String message = "A default message"; // Message to display
7      private int x = 20; // Default x-coordinate
8      private int y = 20; // Default y-coordinate
9
10     /** Determine whether it is an application */
11     private boolean isStandalone = false;                                     isStandalone
12
13     @Override /** Initialize the applet */
14     public void init() {
15         if (!isStandalone) {
16             // Get parameter values from the HTML file
17             message = getParameter("MESSAGE");                               applet params
18             x = Integer.parseInt(getParameter("X"));
19             y = Integer.parseInt(getParameter("Y"));
20         }
21
22         // Create a message panel
23         MessagePanel messagePanel = new MessagePanel(message);
24         messagePanel.setFont(new Font("SansSerif", Font.BOLD, 20));
25         messagePanel.setXCoordinate(x);
26         messagePanel.setYCoordinate(y);
27
28         // Add the message panel to the applet
29         add(messagePanel);
30     }
31
32     /** Main method to display a message
33         @param args[0] x-coordinate
34         @param args[1] y-coordinate
35         @param args[2] message
36     */
37     public static void main(String[] args) {
38         // Create a frame
39         JFrame frame = new JFrame("DisplayMessageApp");
40
41         // Create an instance of the applet
42         DisplayMessageApp applet = new DisplayMessageApp();
43
44         // It runs as an application
45         applet.isStandalone = true;                                         standalone
46
47         // Get parameters from the command line
48         applet.getCommandLineParameters(args);                             command params
49
50         // Add the applet instance to the frame
51         frame.add(applet, BorderLayout.CENTER);

```

```

52
53     // Invoke applet's init method
54     applet.init();
55     applet.start();
56
57     // Display the frame
58     frame.setSize(300, 300);
59     frame.setLocationRelativeTo(null); // Center the frame
60     frame.setDefaultCloseOperation(JFrame.EXIT_ON_CLOSE);
61     frame.setVisible(true);
62 }
63
64 /** Get command-line parameters */
65 private void getCommandLineParameters(String[] args) {
66     // Check usage and get x, y and message
67     if (args.length != 3) {
68         System.out.println(
69             "Usage: java DisplayMessageApp x y message");
70         System.exit(1);
71     }
72     else {
73         x = Integer.parseInt(args[0]);
74         y = Integer.parseInt(args[1]);
75         message = args[2];
76     }
77 }
78 }

```

When you run the program as an applet, the `main` method is ignored. When you run it as an application, the `main` method is invoked. Sample runs of the program as an application and as an applet are shown in Figure 18.7.



FIGURE 18.7 The `DisplayMessageApp` class can run as an applet in (a) and as an application in (b).

The `main` method creates a `JFrame` object `frame` and creates a `JApplet` object `applet`, then places the applet `applet` into the frame `frame` and invokes its `init` method. The application runs just like an applet.

The `main` method sets `isStandalone` as `true` (line 45) so that it does not attempt to retrieve HTML parameters when the `init` method is invoked.

The `setVisible(true)` method (line 61) is invoked *after* the components are added to the applet, and the applet is added to the frame to ensure that the components will be visible. Otherwise, the components are not shown when the frame starts.

omitting `main` method



Important Pedagogical Note

From now on, all the GUI examples will be created as applets with a `main` method. Thus, you will be able to run the program either as an applet or as an application. For brevity, the `main` method is not listed in the text.



18.12 How do you pass parameters to an applet?

18.13 Where is the `getParameter` method defined?

18.14 What is wrong if the `DisplayMessage` applet is revised as follows?

```
public class DisplayMessage extends JApplet {
    /** Initialize the applet */
    public DisplayMessage() {
        // Get parameter values from the HTML file
        String message = getParameter("MESSAGE");
        int x =
            Integer.parseInt(getParameter("X"));
        int y =
            Integer.parseInt(getParameter("Y"));

        // Create a message panel
        MessagePanel messagePanel =
            new MessagePanel(message);
        messagePanel.setXCoordinate(x);
        messagePanel.setYCoordinate(y);

        // Add the message panel to the applet
        add(messagePanel);
    }
}
```

(a) Revision 1

```
public class DisplayMessage extends JApplet {
    private String message;
    private int x;
    private int y;

    @Override /** Initialize the applet */
    public void init() {
        // Get parameter values from the HTML file
        message = getParameter("MESSAGE");
        x = Integer.parseInt(getParameter("X"));
        y = Integer.parseInt(getParameter("Y"));
    }

    public DisplayMessage() {
        // Create a message panel
        MessagePanel messagePanel =
            new MessagePanel(message);
        messagePanel.setXCoordinate(x);
        messagePanel.setYCoordinate(y);

        // Add the message panel to the applet
        add(messagePanel);
    }
}
```

(b) Revision 2

18.8 Case Study: Bouncing Ball

This section presents an applet that displays a ball bouncing in a panel.

The applet uses two buttons to suspend and resume the bouncing movement, and uses a scroll bar to control the bouncing speed, as shown in Figure 18.8.



FIGURE 18.8 The ball's movement is controlled by the *Suspend* and *Resume* buttons and the scroll bar.

Here are the major steps to write this program:

1. Define a subclass of `JPanel` named `Ball` to display a ball bouncing, as shown in Listing 18.7.
2. Define a subclass of `JPanel` named `BallControl` to set the ball speed with a scroll bar, and two control buttons *Suspend* and *Resume*, as shown in Listing 18.8.
3. Define an applet named `BounceBallApp` to contain an instance of `BallControl` and enable the applet to run as a standalone application, as shown in Listing 18.9.

The relationship among these classes is shown in Figure 18.9.

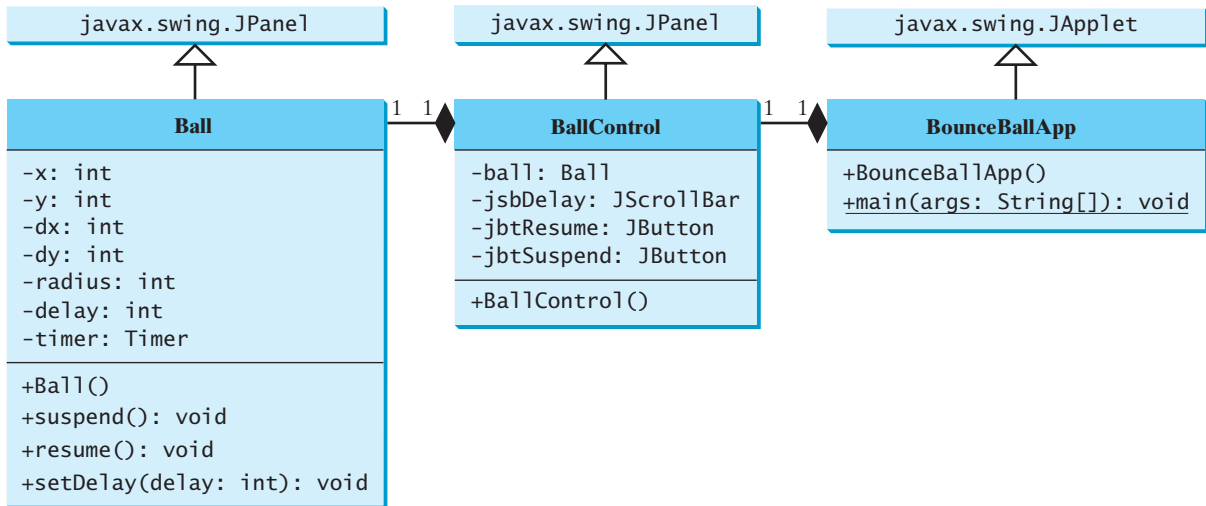


FIGURE 18.9 `BounceBallApp` contains `BallControl`, and `BallControl` contains `Ball`.

LISTING 18.7 `Ball.java`

```

1  import javax.swing.Timer;
2  import java.awt.*;
3  import javax.swing.*;
4  import java.awt.event.*;
5
6  public class Ball extends JPanel {
7      private int delay = 10;
8
9      // Create a timer with the specified delay in milliseconds
10     private Timer timer = new Timer(delay, new TimerListener());
11
12     private int x = 0; private int y = 0; // Current ball position
13     private int radius = 5; // Ball radius
14     private int dx = 2; // Increment on ball's x-coordinate
15     private int dy = 2; // Increment on ball's y-coordinate
16
17     public Ball() {
18         timer.start();
19     }
20
21     private class TimerListener implements ActionListener {
22         @Override /** Handle the action event */
23         public void actionPerformed(ActionEvent e) {
24             repaint();
25         }
26     }
27
28     @Override
29     protected void paintComponent(Graphics g) {
30         super.paintComponent(g);
31
32         g.setColor(Color.red);
33
34         // Check boundaries
35         if (x < 0 || x > getWidth())
36             dx *= -1;
  
```

timer delay

create timer

start timer

timer listener

repaint ball

paint ball


```

37     if (y < 0 || y > getHeight())
38         dy *= -1;
39
40     // Adjust ball position
41     x += dx;
42     y += dy;
43     g.fillOval(x - radius, y - radius, radius * 2, radius * 2);
44 }
45
46 public void suspend() {
47     timer.stop(); // Suspend timer
48 }
49
50 public void resume() {
51     timer.start(); // Resume timer
52 }
53
54 public void setDelay(int delay) {
55     this.delay = delay;
56     timer.setDelay(delay);
57 }
58 }

```

The use of **Timer** to control animation was introduced in Section 16.11, Animation Using the **Timer** Class. **Ball** extends **JPanel** to display a moving ball. The timer listener implements **ActionListener** to listen for **ActionEvent** (line 21). Line 10 creates a **Timer** for a **Ball**. The timer is started in line 18 when a **Ball** is constructed. The timer fires an **ActionEvent** at a fixed rate. The listener responds in line 24 to repaint the ball to animate ball movement. The center of the ball is at **(x, y)**, which changes to **(x + dx, y + dy)** on the next display (lines 41–42). When the ball is out of the horizontal boundary, the sign of **dx** is changed (from positive to negative, or vice versa) (lines 35–36). This causes the ball to change its horizontal movement direction. When the ball is out of the vertical boundary, the sign of **dy** is changed (from positive to negative, or vice versa) (lines 37–38). This causes the ball to change its vertical movement direction. The **suspend** and **resume** methods (lines 46–52) can be used to stop and start the timer. The **setDelay(int)** method (lines 54–57) sets a new delay.

LISTING 18.8 BallControl.java

```

1  import javax.swing.*;
2  import java.awt.event.*;
3  import java.awt.*;
4
5  public class BallControl extends JPanel {
6      private Ball ball = new Ball();
7      private JButton jbtSuspend = new JButton("Suspend");           button
8      private JButton jbtResume = new JButton("Resume");
9      private JScrollBar jsbDelay = new JScrollBar();                scroll bar
10
11     public BallControl() {                                         create UI
12         // Group buttons in a panel
13         JPanel panel = new JPanel();
14         panel.add(jbtSuspend);
15         panel.add(jbtResume);
16
17         // Add ball and buttons to the panel
18         ball.setBorder(new javax.swing.border.LineBorder(Color.red));
19         jsbDelay.setOrientation(JScrollBar.HORIZONTAL);
20         ball.setDelay(jsbDelay.getMaximum());
21         setLayout(new BorderLayout());

```

```

22     add(jsbDelay, BorderLayout.NORTH);
23     add(ball, BorderLayout.CENTER);
24     add(panel, BorderLayout.SOUTH);
25
26     // Register listeners
register listener 27     jbtSuspend.addActionListener(new ActionListener() {
28         @Override
suspend 29         public void actionPerformed(ActionEvent e) {
30             ball.suspend();
31         }
32     });
register listener 33     jbtResume.addActionListener(new ActionListener() {
34         @Override
resume 35         public void actionPerformed(ActionEvent e) {
36             ball.resume();
37         }
38     });
register listener 39     jsbDelay.addAdjustmentListener(new AdjustmentListener() {
40         @Override
new delay 41         public void adjustmentValueChanged(AdjustmentEvent e) {
42             ball.setDelay(jsbDelay.getMaximum() - e.getValue());
43         }
44     });
45 }
46 }

```

The `BallControl` class extends `JPanel` to display the ball with a scroll bar and two control buttons. When the *Suspend* button is clicked, the ball's `suspend()` method is invoked to suspend the ball's movement (line 30). When the *Resume* button is clicked, the ball's `resume()` method is invoked to resume the ball's movement (line 36). The bouncing speed can be changed using the scroll bar.

LISTING 18.9 BounceBallApp.java

```

1  import java.awt.*;
2  import javax.swing.*;
3
4  public class BounceBallApp extends JApplet {
5      public BounceBallApp() {
add BallControl 6          add(new BallControl());
7      }
main method omitted 8  }

```

The `BounceBallApp` class simply places an instance of `BallControl` in the applet. The `main` method is provided in the applet (not displayed in the listing for brevity) so that you can also run it standalone.



18.15 How does the program make the ball moving?

18.16 How does the code in Listing 18.7 `Ball.java` change the direction of the ball movement?

18.17 What does the program do when the *Suspend* button is clicked? What does the program do when the *Resume* button is clicked?

MyProgrammingLab™

18.9 Case Study: Developing a Tic-Tac-Toe Game

This section develops an applet for playing tic-tac-toe.



VideoNote
TicTacToe



From the many examples in this and earlier chapters you have learned about objects, classes, arrays, class inheritance, GUI, event-driven programming, and applets. Now it is time to put

what you have learned to work in developing comprehensive projects. In this section, we will develop a Java applet with which to play the popular game of tic-tac-toe.

Two players take turns marking an available cell in a 3×3 grid with their respective tokens (either X or O). When one player has placed three tokens in a horizontal, vertical, or diagonal row on the grid, the game is over and that player has won. A draw (no winner) occurs when all the cells on the grid have been filled with tokens and neither player has achieved a win. Figure 18.10 shows the representative sample runs of the example.

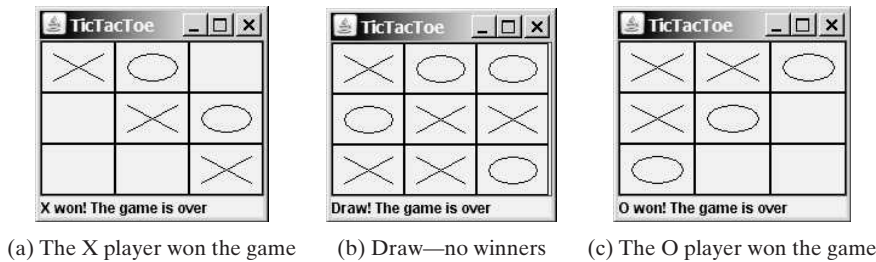


FIGURE 18.10 Two players play a tic-tac-toe game.

All the examples you have seen so far show simple behaviors that are easy to model with classes. The behavior of the tic-tac-toe game is somewhat more complex. To create classes that model the behavior, you need to study and understand the game.

Assume that all the cells are initially empty, and that the first player takes the X token and the second player the O token. To mark a cell, the player points the mouse to the cell and clicks it. If the cell is empty, the token (X or O) is displayed. If the cell is already filled, the player's action is ignored.

From the preceding description, it is obvious that a cell is a GUI object that handles the mouse-click event and displays tokens. Such an object could be either a button or a panel. Drawing on panels is more flexible than drawing on buttons, because on a panel the token (X or O) can be drawn in any size, but on a button it can be displayed only as a text label. Therefore, a panel should be used to model a cell. How do you know the state of the cell (empty, X, or O)? You use a property named `token` of the `char` type in the `Cell` class. The `Cell` class is responsible for drawing the token when an empty cell is clicked, so you need to write the code for listening to the `MouseEvent` and for painting the shapes for tokens X and O. The `Cell` class can be defined as shown in Figure 18.11.

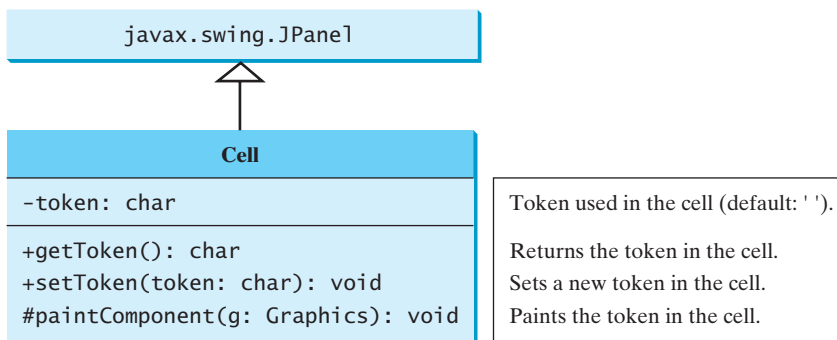


FIGURE 18.11 The `Cell` class paints the token in a cell.

The tic-tac-toe board consists of nine cells, created using `new Cell[3][3]`. To determine which player's turn it is, you can introduce a variable named `whoseTurn` of the `char` type. `whoseTurn` is initially `'X'`, then changes to `'O'`, and subsequently changes between `'X'` and `'O'` whenever a new cell is occupied. When the game is over, set `whoseTurn` to `' '`.

How do you know whether the game is over, whether there is a winner, and who the winner, if any, is? You can define a method named `isWon(char token)` to check whether a specified token has won and a method named `isFull()` to check whether all the cells are occupied.

Clearly, two classes emerge from the foregoing analysis. One is the `Cell` class, which handles operations for a single cell; the other is the `TicTacToe` class, which plays the whole game and deals with all the cells. The relationship between these two classes is shown in Figure 18.12.

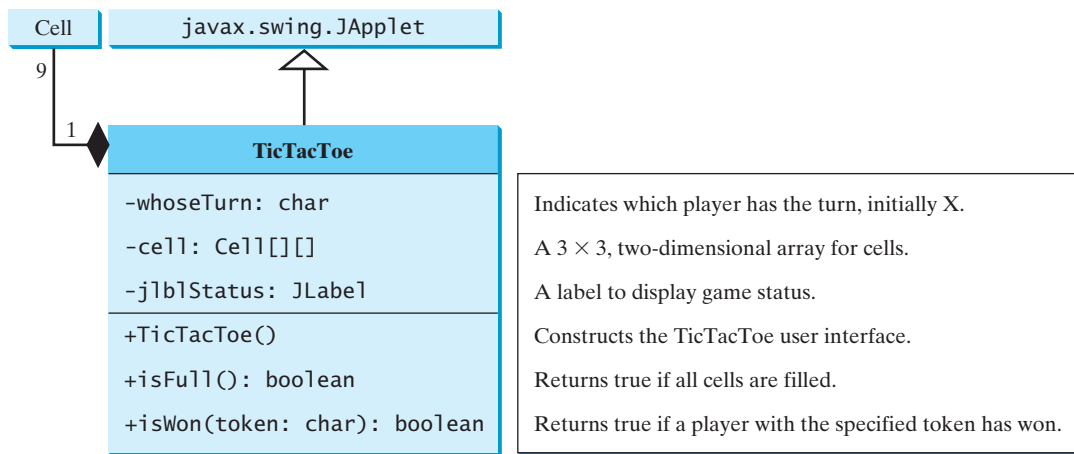


FIGURE 18.12 The `TicTacToe` class contains nine cells.

Since the `Cell` class is only to support the `TicTacToe` class, it can be defined as an inner class in `TicTacToe`. The complete program is given in Listing 18.10.

LISTING 18.10 TicTacToe.java

```

1  import java.awt.*;
2  import java.awt.event.*;
3  import javax.swing.*;
4  import javax.swing.border.LineBorder;
5
6  public class TicTacToe extends JApplet {
7      // Indicate which player has a turn; initially it is the X player
8      private char whoseTurn = 'X';
9
10     // Create and initialize cells
11     private Cell[][] cells = new Cell[3][3];
12
13     // Create and initialize a status label
14     private JLabel jlblStatus = new JLabel("X's turn to play");
15
16     /** Initialize UI */
17     public TicTacToe() {
18         // Panel p to hold cells

```

main class TicTacToe

```

19  JPanel p = new JPanel(new GridLayout(3, 3, 0, 0));
20  for (int i = 0; i < 3; i++)
21      for (int j = 0; j < 3; j++)
22          p.add(cells[i][j] = new Cell());
23
24  // Set line borders on the cells' panel and the status label
25  p.setBorder(new LineBorder(Color.red, 1));
26  jlblStatus.setBorder(new LineBorder(Color.yellow, 1));
27
28  // Place the panel and the label for the applet
29  add(p, BorderLayout.CENTER);
30  add(jlblStatus, BorderLayout.SOUTH);
31  }
32
33  /** Determine whether the cells are all occupied */
34  public boolean isFull() {                                check isFull
35      for (int i = 0; i < 3; i++)
36          for (int j = 0; j < 3; j++)
37              if (cells[i][j].getToken() == ' ')
38                  return false;
39
40      return true;
41  }
42
43  /** Determine whether the player with the specified token wins */
44  public boolean isWon(char token) {
45      for (int i = 0; i < 3; i++)                          check rows
46          if ((cells[i][0].getToken() == token)
47              && (cells[i][1].getToken() == token)
48              && (cells[i][2].getToken() == token)) {
49              return true;
50          }
51
52      for (int j = 0; j < 3; j++)                          check columns
53          if ((cells[0][j].getToken() == token)
54              && (cells[1][j].getToken() == token)
55              && (cells[2][j].getToken() == token)) {
56              return true;
57          }
58
59      if ((cells[0][0].getToken() == token)                check major diagonal
60          && (cells[1][1].getToken() == token)
61          && (cells[2][2].getToken() == token)) {
62          return true;
63      }
64
65      if ((cells[0][2].getToken() == token)                check subdiagonal
66          && (cells[1][1].getToken() == token)
67          && (cells[2][0].getToken() == token)) {
68          return true;
69      }
70
71      return false;
72  }
73
74  // An inner class for a cell
75  public class Cell extends JPanel {                       inner class Cell
76      // Token used for this cell
77      private char token = ' ';
78  }

```

```

79     public Cell() {
80         setBorder(new LineBorder(Color.black, 1)); // Set cell's border
register listener 81         addMouseListener(new MyMouseListener()); // Register listener
82     }
83
84     /** Return token */
85     public char getToken() {
86         return token;
87     }
88
89     /** Set a new token */
90     public void setToken(char c) {
91         token = c;
92         repaint();
93     }
94
95     @Override /** Paint the cell */
paint cell 96     protected void paintComponent(Graphics g) {
97         super.paintComponent(g);
98
99         if (token == 'X') {
100             g.drawLine(10, 10, getWidth() - 10, getHeight() - 10);
101             g.drawLine(getWidth() - 10, 10, 10, getHeight() - 10);
102         }
103         else if (token == 'O') {
104             g.drawOval(10, 10, getWidth() - 20, getHeight() - 20);
105         }
106     }
107
listener class 108     private class MyMouseListener extends MouseAdapter {
109         @Override /** Handle mouse click on a cell */
110         public void mouseClicked(MouseEvent e) {
111             // If cell is empty and game is not over
112             if (token == ' ' && whoseTurn != ' ') {
113                 setToken(whoseTurn); // Set token in the cell
114
115                 // Check game status
116                 if (isWon(whoseTurn)) {
117                     jlblStatus.setText(whoseTurn + " won! The game is over");
118                     whoseTurn = ' '; // Game is over
119                 }
120                 else if (isFull()) {
121                     jlblStatus.setText("Draw! The game is over");
122                     whoseTurn = ' '; // Game is over
123                 }
124                 else {
125                     // Change the turn
126                     whoseTurn = (whoseTurn == 'X') ? 'O' : 'X';
127                     // Display whose turn
128                     jlblStatus.setText(whoseTurn + "'s turn");
129                 }
130             }
131         }
132     }
133 }
main method omitted 134 }

```

The `TicTacToe` class initializes the user interface with nine cells placed in a panel of `GridLayout` (lines 19–22). A label named `jlblStatus` is used to show the status of the game (line 14). The variable `whoseTurn` (line 8) is used to track the next type of token to be

placed in a cell. The methods `isFull` (lines 34–41) and `isWon` (lines 44–72) are for checking the status of the game.

Since `Cell` is an inner class in `TicTacToe`, the variable (`whoseTurn`) and methods (`isFull` and `isWon`) defined in `TicTacToe` can be referenced from the `Cell` class. The inner class makes programs simple and concise. If `Cell` were not defined as an inner class of `TicTacToe`, you would have to pass an object of `TicTacToe` to `Cell` in order for the variables and methods in `TicTacToe` to be used in `Cell`. You will rewrite the program without using an inner class in Programming Exercise 18.6.

The listener for `MouseEvent` is registered for the cell (line 81). If an empty cell is clicked and the game is not over, a token is set in the cell (line 113). If the game is over, `whoseTurn` is set to ' ' (lines 118, 122). Otherwise, `whoseTurn` is alternated to a new turn (line 126).



Tip

Use an incremental approach in developing and testing a Java project of this kind. For example, this program can be divided into five steps:

1. Lay out the user interface and display a fixed token X on a cell.
2. Enable the cell to display a fixed token X upon a mouse click.
3. Coordinate between the two players so as to display tokens X and O alternately.
4. Check whether a player wins, or whether all the cells are occupied without a winner.
5. Implement displaying a message on the label upon each move by a player.

- 18.18** When the game starts, what value is in `whoseTurn`? When the game is over, what value is in `whoseTurn`?
- 18.19** What happens when the user clicks on an empty cell if the game is not over? What happens when the user clicks on an empty cell if the game is over?
- 18.20** How does the program check whether a player wins? How does the program check whether all cells are filled?
- 18.21** Delete `super.paintComponent(g)` on line 97 in `TicTacToe.java` in Listing 18.10 and run the program to see what happens.

incremental development and testing



MyProgrammingLab™

18.10 Locating Resources Using the URL Class

You can use the `URL` class to load a resource file for an applet, as long as the resource file is located in the applet's class directory.

You have used the `ImageIcon` class to create an icon from an image file and used the `setIcon` method or the constructor to place the icon in a GUI component, such as a button or a label. For example, the following statements create an `ImageIcon` and set it on a `JLabel` object `jlb1`:

```
ImageIcon imageIcon = new ImageIcon("c:\\book\\image\\us.gif");
jlb1.setIcon(imageIcon);
```

This approach presents a problem. The file location is fixed, because it uses the absolute file path on the Windows platform. As a result, the program cannot run on other platforms and cannot run as an applet. Assume that `image/us.gif` is under the class directory. You can circumvent this problem by using a relative path as follows:

```
ImageIcon imageIcon = new ImageIcon("image/us.gif");
```

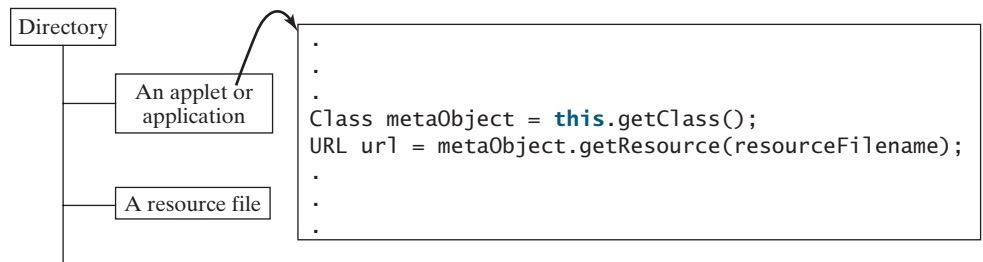
This works fine with Java applications on all platforms but not with Java applets, because applets cannot load local files. To enable it to work with both applications and applets, you need to locate the file's *URL* (Uniform Resource Locator).



why URL class?

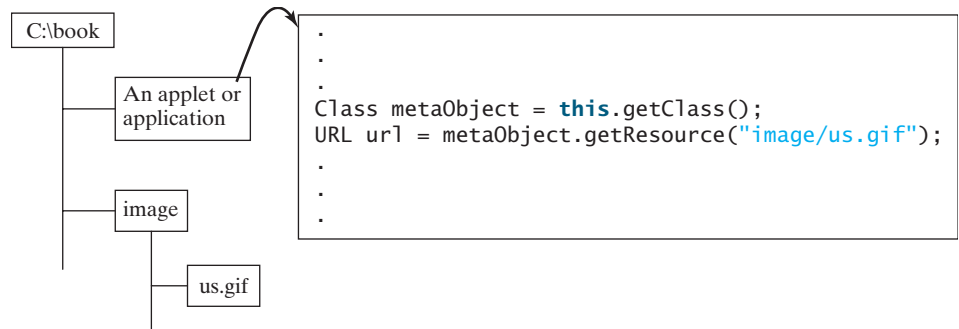
The `java.net.URL` class was used to locate a text file on the Internet in Section 14.13. It can also be used to locate image files and audio files on the Internet. In general, a `URL` object is a pointer to a “resource” on a local machine or a remote host. A resource can be a file or a directory.

The `URL` class can be used to locate a resource file from a class in a way that is independent of the file’s location, as long as the resource file is located in the class directory. Recall that the class directory is where the class is stored. To obtain the `URL` object for a file from a class, use the following statement in the applet or application:



The `getClass()` method returns an instance of the `java.lang.Class` class for the current class. This instance is automatically created by the JVM for every class loaded into the memory. This instance, also known as a *meta object*, contains the information about the class file such as class name, constructors, and methods. You can obtain a `URL` object for a file in the class path by invoking the `getResource(filename)` method on the meta object. For example, if the class file is in `c:\book`, the following statements obtain a `URL` object for `c:\book\image\us.gif`.

meta object



You can now create an `ImageIcon` using

```
ImageIcon imageIcon = new ImageIcon(url);
```

Listing 18.11 gives the code that displays an image from `image/us.gif` in the class directory. The file `image/us.gif` is under the class directory, and its `URL` object is obtained using the `getResource` method (line 5). A label with an image icon is created in line 6. The image icon is obtained from the `URL` object.

LISTING 18.11 DisplayImageWithURL.java

```

1 import javax.swing.*;
2
3 public class DisplayImageWithURL extends JApplet {

```



```

4 public DisplayImageWithURL() {
5     java.net.URL url = this.getClass().getResource("image/us.gif");
6     add(new JLabel(new ImageIcon(url)));
7 }
8 }

```

get image URL
create a label
main method omitted

If you replace the code in lines 5–6 with the following code,

```
add(new JLabel(new ImageIcon("image/us.gif")));
```

you can still run the program as a standalone application, but not as an applet from a browser, as shown in Figure 18.13.



FIGURE 18.13 The applet loads an image from an image file located in the same directory as the applet.

18.22 How do you create a **URL** object for the file **image/us.gif** in the class directory?

18.23 How do you create an **ImageIcon** from the file **image/us.gif** in the class directory?



MyProgrammingLab™

18.1.1 Playing Audio in Any Java Program

The **Applet** class contains the methods for obtaining an **AudioClip** object for an audio file. The **AudioClip** object contains the methods for playing audio files.



There are several formats for audio files. Java programs can play audio files in the WAV, AIFF, MIDI, AU, and RMF formats.

To play an audio file in Java (application or applet), first create an *audio clip object* for the file. The audio clip is created once and can be played repeatedly without reloading the file. To create an audio clip, use the static method **newAudioClip()** in the **java.applet.Applet** class:

```
AudioClip audioClip = Applet.newAudioClip(url);
```

Audio originally could be played only from Java applets. For this reason, the **AudioClip** interface is in the **java.applet** package. Since JDK 1.2, audio can be played in any Java program.

The following statements, for example, create an **AudioClip** for the **beep.au** audio file in the class directory:

```

Class metaObject = this.getClass();
URL url = metaObject.getResource("beep.au");
AudioClip audioClip = Applet.newAudioClip(url);

```

To manipulate a sound for an audio clip, use the `play()`, `loop()`, and `stop()` methods in `java.applet.AudioClip`, as shown in Figure 18.14.

«interface» <i>java.applet.AudioClip</i>	
<i>+play()</i>	Starts playing this audio clip. Each time this method is called, the clip is restarted from the beginning.
<i>+loop()</i>	Plays the clip repeatedly.
<i>+stop()</i>	Stops playing the clip.

FIGURE 18.14 The `AudioClip` interface provides the methods for playing sound.

Listing 18.12 gives the code that displays the Danish flag and plays the Danish national anthem repeatedly. The image file `image/denmark.gif` and audio file `audio/denmark.mid` are stored under the class directory. Line 12 obtains the `URL` object for the audio file, line 13 creates an audio clip for the file, and line 14 repeatedly plays the audio.

LISTING 18.12 `DisplayImagePlayAudio.java`

<p>get image URL create a label</p> <p>get audio URL create an audio clip play audio repeatedly</p> <p>start audio</p> <p>stop audio</p> <p>main method omitted</p>	<pre> 1 import javax.swing.*; 2 import java.net.URL; 3 import java.applet.*; 4 5 public class DisplayImagePlayAudio extends JApplet { 6 private AudioClip audioClip; 7 8 public DisplayImagePlayAudio() { 9 URL urlForImage = getClass().getResource("image/denmark.gif"); 10 add(new JLabel(new ImageIcon(urlForImage))); 11 12 URL urlForAudio = getClass().getResource("audio/denmark.mid"); 13 audioClip = Applet.newAudioClip(urlForAudio); 14 audioClip.loop(); 15 } 16 17 @Override 18 public void start() { 19 if (audioClip != null) audioClip.loop(); 20 } 21 22 @Override 23 public void stop() { 24 if (audioClip != null) audioClip.stop(); 25 } 26 }</pre>
---	---

The `stop` method (lines 23–25) stops the audio when the applet is not displayed, and the `start` method (lines 18–20) restarts the audio when the applet is redisplayed. Try to run this applet without the `stop` and `start` methods from a browser and observe the effect.

Run this program as a standalone application from the main method and from a Web browser to test it. Recall that, for brevity, the `main` method in all applets is not printed in the text.



18.24 What types of audio files are used in Java?

18.25 How do you create an audio clip from the file `anthem/us.mid` in the class directory?

18.26 How do you play, repeatedly play, and stop an audio clip?

18.12 Case Study: National Flags and Anthems

This case study presents an applet that displays a nation's flag and plays its anthem.



The images in the applet are for seven national flags, named **flag0.gif**, **flag1.gif**, . . . , **flag6.gif** for Denmark, Germany, China, India, Norway, the U.K., and the U.S. They are stored under the **image** directory in the class path. The audio consists of national anthems for these seven nations, named **anthem0.mid**, **anthem1.mid**, . . . , and **anthem6.mid**. They are stored under the **audio** directory in the class path.

The program enables the user to select a nation from a combo box and then displays its flag and plays its anthem. The user can suspend the audio by clicking the *Suspend* button and resume it by clicking the *Resume* button, as shown in Figure 18.15.



FIGURE 18.15 The applet displays a sequence of images and plays audio.

The program is given in Listing 18.13.

LISTING 18.13 FlagAnthem.java

```

1  import java.awt.*;
2  import java.awt.event.*;
3  import javax.swing.*;
4  import java.applet.*;
5
6  public class FlagAnthem extends JApplet {
7      private final static int NUMBER_OF_NATIONS = 7;
8      private int current = 0;
9      private ImageIcon[] icons = new ImageIcon[NUMBER_OF_NATIONS];
10     private AudioClip[] audioClips = new AudioClip[NUMBER_OF_NATIONS];
11     private AudioClip currentAudioClip;
12
13     private JLabel jlblImageLabel = new JLabel();
14     private JButton jbtResume = new JButton("Resume");
15     private JButton jbtSuspend = new JButton("Suspend");
16     private JComboBox jcbnations = new JComboBox(new Object[]
17         {"Denmark", "Germany", "China", "India", "Norway", "UK", "US"});
18
19     public FlagAnthem() {
20         // Load image icons and audio clips
21         for (int i = 0; i < NUMBER_OF_NATIONS; i++) {
22             icons[i] = new ImageIcon(getClass().getResource(
23                 "image/flag" + i + ".gif"));
24             audioClips[i] = Applet.newAudioClip(
25                 getClass().getResource("audio/anthem" + i + ".mid"));
26         }
27
28         JPanel panel = new JPanel();

```



VideoNote

Audio and image

image icons
audio clips
current audio clip

GUI components

create icons

create audio clips

create UI

```

29     panel.add(jbtResume);
30     panel.add(jbtSuspend);
31     panel.add(new JLabel("Select"));
32     panel.add(jcboNations);
33     add(jlblImageLabel, BorderLayout.CENTER);
34     add(panel, BorderLayout.SOUTH);
35
register listener    36     jbtResume.addActionListener(new ActionListener() {
37         @Override
38         public void actionPerformed(ActionEvent e) {
start audio        39         start();
40     }
41     });
register listener    42     jbtSuspend.addActionListener(new ActionListener() {
43         @Override
44         public void actionPerformed(ActionEvent e) {
stop audio         45         stop();
46     }
47     });
register listener    48     jcboNations.addActionListener(new ActionListener() {
49         @Override
50         public void actionPerformed(ActionEvent e) {
select a nation    51         stop();
52         current = jcboNations.getSelectedIndex();
present a nation   53         presentNation(current);
54     }
55     });
56
57     lblImageLabel.setIcon(icons[0]);
58     lblImageLabel.setHorizontalAlignment(JLabel.CENTER);
59     currentAudioClip = audioClips[0];
60     currentAudioClip.play();
61 }
62
63 private void presentNation(int index) {
64     lblImageLabel.setIcon(icons[index]);
65     jcboNations.setSelectedIndex(index);
66     currentAudioClip = audioClips[index];
67     currentAudioClip.play();
68 }
69
70 @Override
71 public void start() {
play a clip       72     currentAudioClip.play();
73 }
74
75 @Override
76 public void stop() {
stop audio clip   77     currentAudioClip.stop();
78 }
main method omitted 79 }

```

A label is created in line 13 to display a flag image. An array of flag images for seven nations is created in lines 22–23. An array of audio clips is created in lines 24–25. The image files and audio files are stored in the same directory as the applet class file so these files can be located using the `getResource` method.

The combo box for country names is created in lines 16–17. When a new country name in the combo box is selected, the current presentation is stopped and a new selected nation is presented (lines 51–53).

The `presentNation(index)` method (lines 63–68) presents a nation with the specified index. It sets a new image in the label (line 64), synchronizes with the combo box by setting the selected index (line 65), and plays the new audio (line 67).

The applet's `start` and `stop` methods are overridden to resume and suspend the audio (lines 70–78).

18.27 Which code sets the initial image icon? Which code plays the initial audio clip?

18.28 What does the program do when the *Suspend* button is clicked? What does the program do when the *Resume* button is clicked?



MyProgrammingLab™

KEY TERMS

applet 673

applet container 677

archive 674

HTML 673

signed applet 676

tag 673

CHAPTER SUMMARY

- JApplet** is a subclass of **Applet**. It is used for developing Java applets with Swing components.
- The applet class file must be specified, using the `<applet>` tag in an *HTML file* to tell the Web browser where to find the applet. The applet can accept string parameters from HTML using the `<param>` tag.
- The *applet container* controls and executes applets through the `init`, `start`, `stop`, and `destroy` methods in the **Applet** class.
- When an applet is loaded, the applet container creates an instance of it by invoking its no-arg constructor. The `init` method is invoked after the applet is created. The `start` method is invoked after the `init` method. It is also called whenever the applet becomes active again after the page containing the applet is revisited. The `stop` method is invoked when the applet becomes inactive.
- The `destroy` method is invoked when the browser exits normally to inform the applet that it is no longer needed and should release any resources it has allocated. The `stop` method is always called before the `destroy` method.
- Applications and applets are very similar. An applet can easily be converted into an application, and vice versa. Moreover, an applet can be written with a `main` method to run standalone.
- You can pass arguments to an applet using the `param` attribute in the applet's tag in HTML. To retrieve the value of the parameter, invoke the `getParameter(paramName)` method.
- The **Applet**'s `getParameter` method can be invoked only after an instance of the applet is created. Therefore, this method cannot be invoked in the constructor of the applet class. You should invoke this method from the `init` method.
- You learned how to incorporate images and audio in Java applications and applets. To load audio and images for Java applications and applets, you have to create a **URL** object for the audio and image file. The resource files must be stored in the class directory.

- 10.** To play an audio, create an audio clip from the `URL` object for the audio source. You can use the `AudioClip`'s `play()` method to play it once, the `loop()` method to play it repeatedly, and the `stop()` method to stop it.

TEST QUESTIONS

Do the test questions for this chapter online at www.cs.armstrong.edu/liang/intro9e/test.html.

MyProgrammingLab™

PROGRAMMING EXERCISES



Pedagogical Note

For every applet in the exercise, add a main method to enable it to run as a stand-alone application.

Sections 18.2–18.6

- 18.1** (*Loan calculator*) Revise Listing 16.7, `LoanCalculator.java`, to be an applet for computing loan payment.
- 18.2** (*Convert applications to applets*) Rewrite `ClockAnimation` in Listing 16.12 as an applet and enable it to run standalone.
- *18.3** (*Guess capitals and states*) Revise Programming Exercise 9.17 to write an applet that repeatedly prompts the user to enter a capital for a state or vice versa, as shown in Figure 18.16a. Upon clicking the *Answer* button, the program gets the user input from the text field, reports whether the answer is correct in a message dialog box (Figure 18.16b–c), shows the correct count and total count, and then displays the next question. The user can specify whether to let the program generate a question randomly or sequentially, and whether to generate questions for a capital or a state.

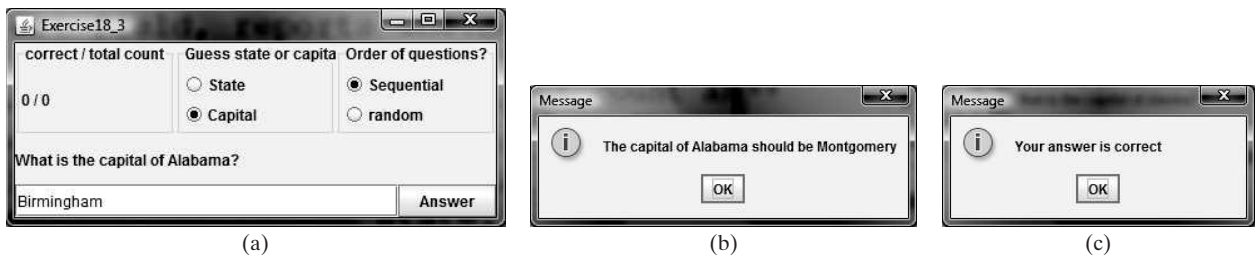


FIGURE 18.16 The applet tests the user knowledge on states and capitals.

- *18.4** (*Pass strings to applets*) Rewrite Listing 18.5, `DisplayMessage.java`, to display a message with a standard color, font, and size. The `message`, `x`, `y`, `color`, `fontname`, and `fontsize` are parameters in the `<applet>` tag, as shown below:

```
<applet
  code = "Exercisel8_04.class"
  width = 200
  height = 50
  alt = "You must have a Java-enabled browser to view the applet"
>
<param name = MESSAGE value = "Welcome to Java" />
<param name = X value = 40 />
<param name = Y value = 50 />
<param name = COLOR value = "red" />
```

```

    <param name = FONTNAME value = "Monospaced" />
    <param name = FONTSIZE value = 20 />
</applet>

```

- **18.5** (*Game: a clock learning tool*) Develop a clock applet to show a first-grade student how to read a clock. Modify Programming Exercise 13.19 to display a detailed clock with an hour hand and a minute hand in an applet, as shown in Figure 18.17a. The hour and minute values are randomly generated. The hour is between 0 and 11, and the minute is 0, 15, 30, or 45. Upon a mouse click, a new random time is displayed on the clock.

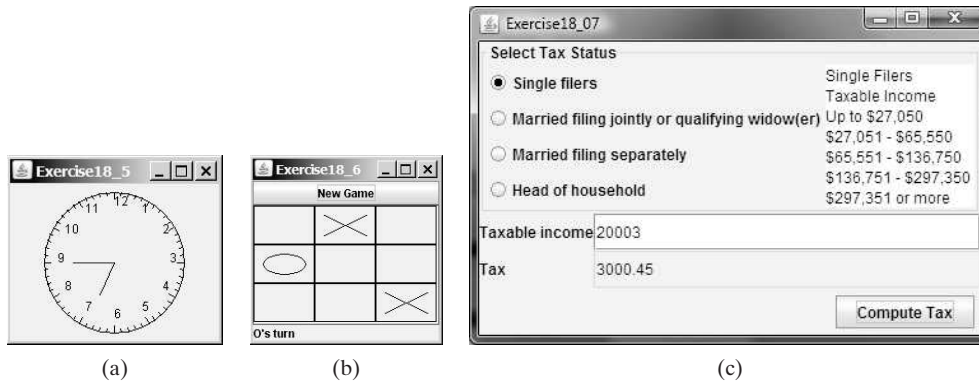


FIGURE 18.17 (a) Upon a mouse click on the clock, the clock time is randomly displayed. (b) Clicking the *New Game* button starts a new game. (c) The tax calculator computes the tax for the specified taxable income and tax status.

- **18.6** (*Game: tic-tac-toe*) Rewrite the program in Listing 18.10 TicTacToe.java with the following modifications:
- Define **Cell** as a separate class rather than an inner class.
 - Add a button named *New Game*, as shown in Figure 18.17b. Clicking the *New Game* button starts a new game.
- **18.7** (*Financial application: tax calculator*) Create an applet to compute tax, as shown in Figure 18.17c. The applet lets the user select the tax status and enter the taxable income to compute the tax based on the 2001 federal tax rates, as shown in Programming Exercise 10.8.
- ***18.8** (*Create a calculator*) Use various panels of **FlowLayout**, **GridLayout**, and **BorderLayout** to lay out the following calculator and to implement addition (+), subtraction (-), division (/), square root (**sqrt**), and modulus (%) functions (see Figure 18.18a).

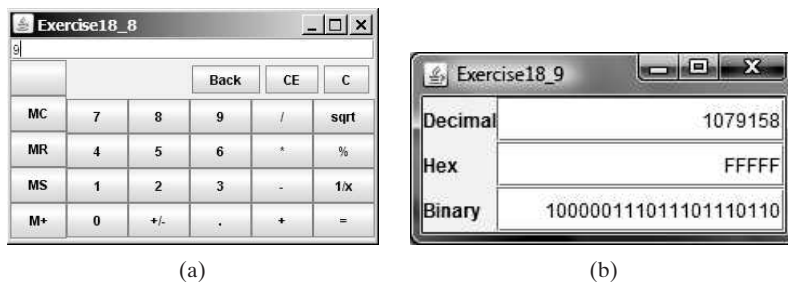


FIGURE 18.18 (a) Exercise 18.8 is a Java implementation of a popular calculator. (b) Exercise 18.9 converts between decimal, hex, and binary numbers.

- *18.9** (*Convert numbers*) Write an applet that converts between decimal, hex, and binary numbers, as shown in Figure 18.18b. When you enter a decimal value in the decimal-value text field and press the *Enter* key, its corresponding hex and binary numbers are displayed in the other two text fields. Likewise, you can enter values in the other fields and convert them accordingly.
- **18.10** (*Repaint a partial area*) When you repaint the entire viewing area of a panel, sometimes only a tiny portion of the viewing area is changed. You can improve the performance by repainting only the affected area, but do not invoke `super.paintComponent(g)` when repainting the panel, because this will cause the entire viewing area to be cleared. Use this approach to write an applet to display the temperatures of each hour during the last 24 hours in a histogram. Suppose that temperatures between 50 and 90 degrees Fahrenheit are obtained randomly and are updated every hour. The temperature of the current hour needs to be redisplayed, while the others remain unchanged. Use a unique color to highlight the temperature for the current hour (see Figure 18.19a).

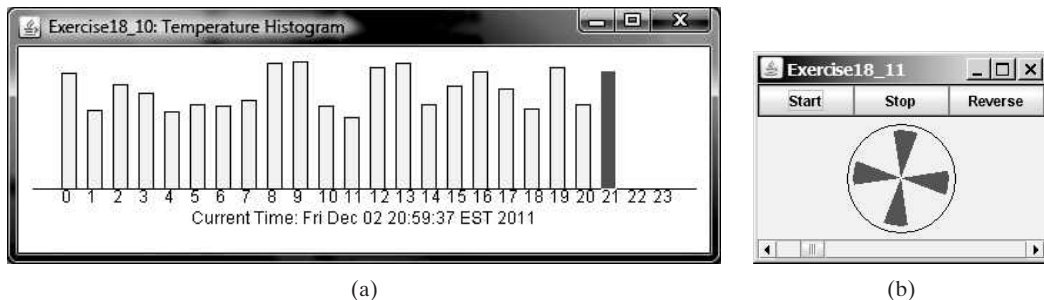


FIGURE 18.19 (a) The histogram displays the average temperature of every hour in the last 24 hours. (b) The program simulates a running fan.

- **18.11** (*Simulation: a running fan*) Write a Java applet that simulates a running fan, as shown in Figure 18.19b. The buttons *Start*, *Stop*, and *Reverse* control the fan. The scrollbar controls the fan's speed. Create a class named `Fan`, a subclass of `JPanel`, to display the fan. This class also contains the methods to suspend and resume the fan, set its speed, and reverse its direction. Create a class named `FanControl` that contains a fan, and three buttons and a scroll bar to control the fan. Create a Java applet that contains an instance of `FanControl`.
- **18.12** (*Control a group of fans*) Write a Java applet that displays three fans in a group, with control buttons to start and stop all of them, as shown in Figure 18.20.



FIGURE 18.20 The program runs and controls a group of fans.

- ***18.13** (*Create an elevator simulator*) Write an applet that simulates an elevator going up and down (see Figure 18.21). The buttons on the left indicate the floor where the passenger is now located. The passenger must click a button on the left to

request that the elevator come to his or her floor. On entering the elevator, the passenger clicks a button on the right to request that it go to the specified floor.

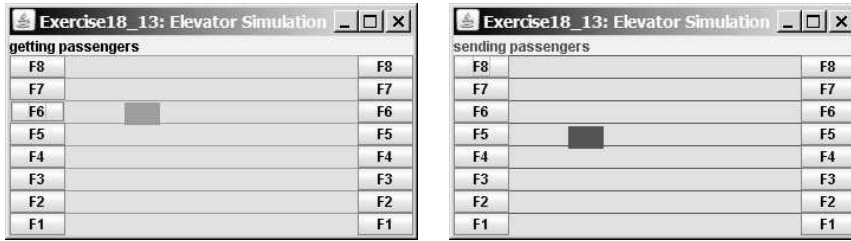


FIGURE 18.21 The program simulates elevator operations.



VideoNote

Control a group of clocks

***18.14** (*Control a group of clocks*) Write a Java applet that displays three clocks in a group, with control buttons to start and stop all of them, as shown in Figure 18.22.



FIGURE 18.22 Three clocks run independently with individual control and group control.

Sections 18.10–18.12

***18.15** (*Enlarge and shrink an image*) Write an applet that will display a sequence of images from a single image file in different sizes. Initially, the viewing area for this image has a width of 300 and a height of 300. Your program should continuously shrink the viewing area by 1 in width and 1 in height until it reaches a width of 50 and a height of 50. At that point, the viewing area should continuously enlarge by 1 in width and 1 in height until it reaches a width of 300 and a height of 300. The viewing area should shrink and enlarge (alternately) to create animation for the single image.

*****18.16** (*Simulate a stock ticker*) Write a Java applet that displays a stock-index ticker (see Figure 18.23). The stock-index information is passed from the `<param>` tag in the HTML file. Each index has four parameters: Index Name (e.g., S&P

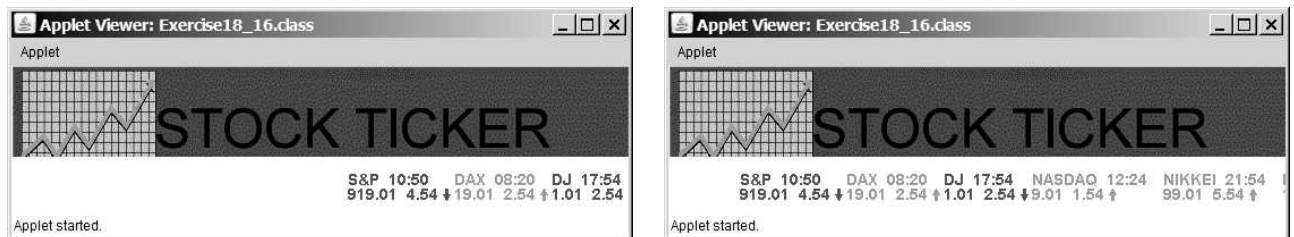


FIGURE 18.23 The program displays a stock-index ticker.

500), Current Time (e.g., 15:54), the index from the previous day (e.g., 919.01), and Change (e.g., 4.54). Use at least five indexes, such as Dow Jones, S&P 500, NASDAQ, NIKKEI, and Gold & Silver Index. Display positive changes in green and negative changes in red. The indexes move from right to left in the applet's viewing area. The applet freezes the ticker when the mouse button is pressed; it moves again when the mouse button is released.

****18.17** (*Racing cars*) Write an applet that simulates four cars racing, as shown in Figure 18.24a. You can set the speed for each car, with maximum 100.

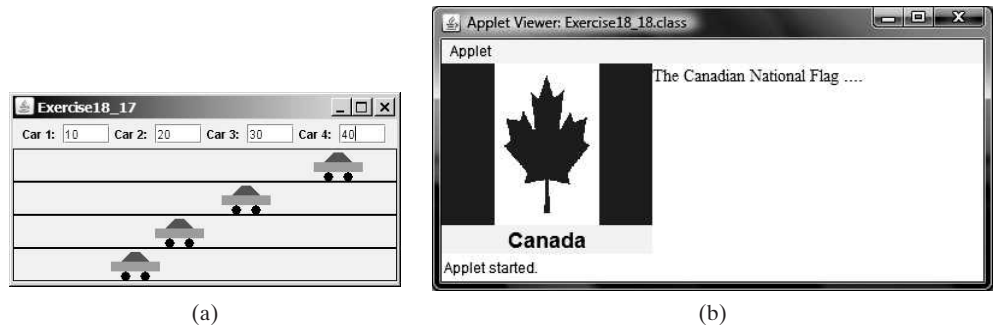


FIGURE 18.24 (a) You can set the speed for each car. (b) This applet shows each country's flag, name, and description, one after another, and reads the description that is currently shown.

****18.18** (*Show national flags*) Write an applet that introduces national flags, one after the other, by presenting each one's photo, name, and description (see Figure 18.24b) along with audio that reads the description. Suppose your applet displays the flags of eight countries. Assume that the photo image files, named **flag0.gif**, **flag1.gif**, and so on, up to **flag7.gif**, are stored in a subdirectory named **image** in the applet's directory. The length of each audio is less than 10 seconds. Assume that the name and description of each country's flag are passed from the HTML using the parameters **name0**, **name1**, . . . , **name7**, and **description0**, **description1**, . . . , and **description7**. Pass the number of countries as an HTML parameter using **numberOfCountries**. Here is an example:

```
<param name = "numberOfCountries" value = 8>
<param name = "name0" value = "Canada">
<param name = "description0" value = "The Canadian ... ">
```



Hint

Use the **DescriptionPanel** class to display the image, name, and the text. The **DescriptionPanel** class was introduced in Listing 17.2.

*****18.19** (*Bouncing balls*) The example in Section 18.8 simulates a bouncing ball. Extend the example to allow multiple balls, as shown in Figure 18.25a. You can use the **+1** or **-1** button to increase or decrease the number of the balls, and use the **Suspend** and **Resume** buttons to freeze the balls or resume bouncing. For each ball, assign a random color.

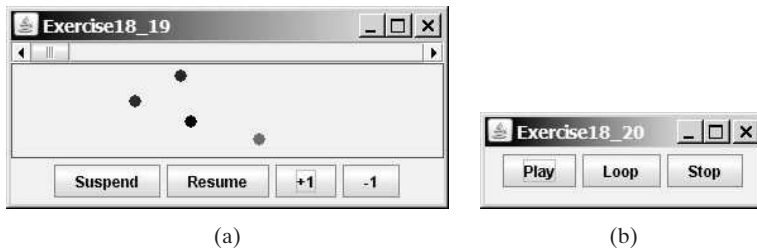


FIGURE 18.25 (a) The applet allows you to add or remove bouncing balls. (b) Click *Play* to play an audio clip once, click *Loop* to play an audio repeatedly, and click *Stop* to terminate playing.

***18.20** (*Play, loop, and stop a sound clip*) Write an applet that meets the following requirements:

- Get an audio file from the class directory.
- Place three buttons labeled *Play*, *Loop*, and *Stop*, as shown in Figure 18.25b.
- If you click the *Play* button, the audio file is played once. If you click the *Loop* button, the audio file keeps playing repeatedly. If you click the *Stop* button, the playing stops.
- The applet can run as an application.

****18.21** (*Create an alarm clock*) Write an applet that will display a digital clock with a large display panel that shows the hour, minute, and second. This clock should allow the user to set an alarm. Figure 18.26a shows an example of such a clock. To turn on the alarm, check the *Alarm* check box. To specify the alarm time, click the *Set alarm* button to display a new frame, as shown in Figure 18.26b. You can set the alarm time in the frame.

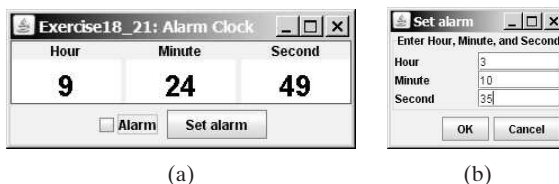


FIGURE 18.26 The program displays the current hour, minute, and second and enables you to set an alarm.

****18.22** (*Create an image animator with audio*) Create animation using the applet shown in Figure 18.27 to meet the following requirements:

- Allow the user to specify the animation speed in a text field.
- Get the number of frames and the image's file-name prefix from the user. For example, if the user enters *n* for the number of frames and *L* for the image prefix, then the files are *L1*, *L2*, and so on, to *Ln*. Assume that the images are stored in the **image** directory, a subdirectory of the applet's directory.
- Allow the user to specify an audio file name. The audio file is stored in the same directory as the applet. The sound is played while the animation runs.

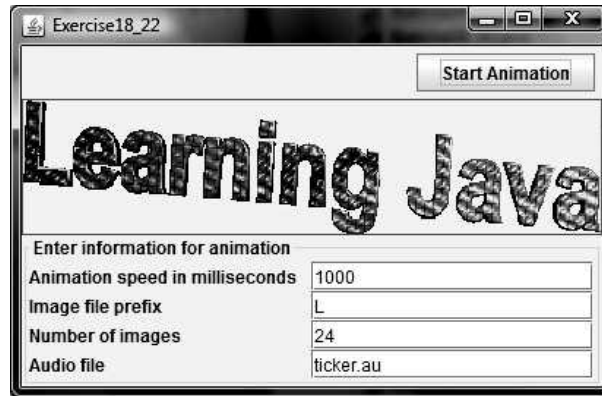


FIGURE 18.27 This applet lets the user select image files, an audio file, and the animation speed.

****18.23** (*Simulation: raise flag and play anthem*) Create an applet that displays a flag rising up, as shown in Figure 16.1b–d. As the national flag rises, play the national anthem. (You may use a flag image and anthem audio file from Listing 18.13.)

Comprehensive

*****18.24** (*Game: bean-machine animation*) Write an applet that enhances the bean machine animation in Programming Exercise 16.22. The applet lets you set the number of slots, as shown in Figure 18.28. Click *Start* to start or restart the animation and click *Stop* to stop.

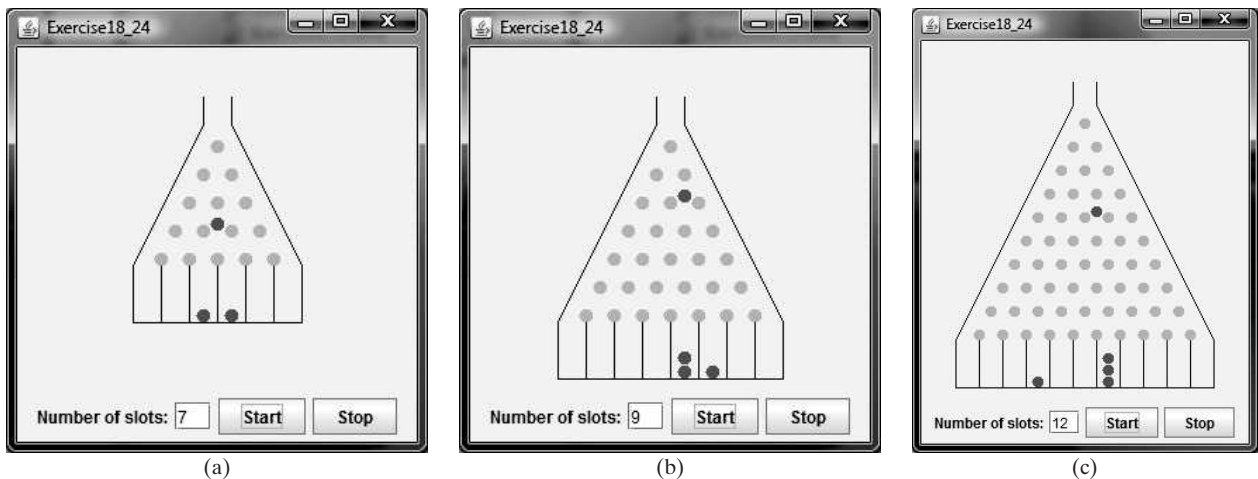


FIGURE 18.28 The applet controls a bean-machine animation.

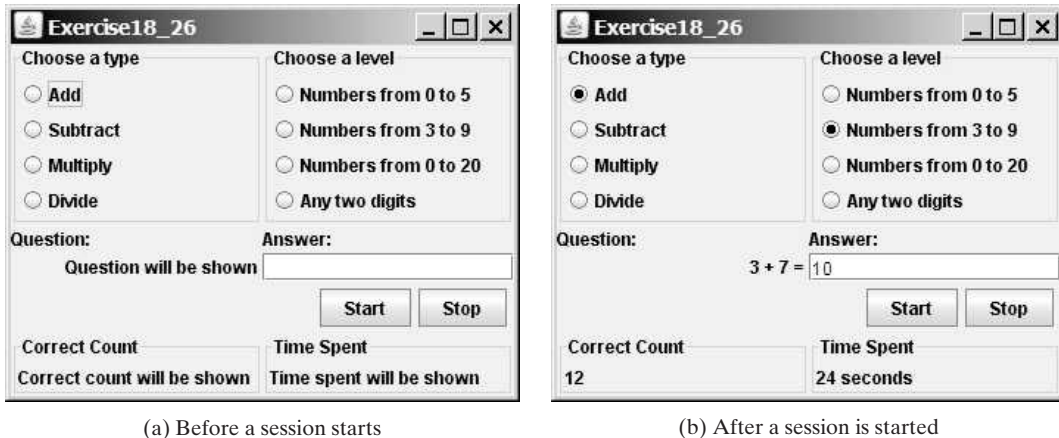
****18.25** (*Game: guess birthdays*) Listing 3.3, `GuessBirthday.java`, gives a program for guessing a birthday. Create an applet for guessing birthdays as shown in Figure 18.29. The applet prompts the user to check whether the date is in any of the five sets. The date is displayed in the text field upon clicking the *Guess Birthday* button.

*****18.26** (*Game: math quiz*) Listing 3.1, `AdditionQuiz.java`, and Listing 3.4, `SubtractionQuiz.java`, generate and grade math quizzes. Write an applet that allows



FIGURE 18.29 This applet guesses the birthday.

the user to select a question type and difficulty level, as shown in Figure 18.30a. When the user clicks the *Start* button, the program begins to generate a question. After the user enters an answer with the *Enter* key, a new question is displayed. When the user clicks the *Start* button, the elapsed time is displayed. The time is updated every second until the *Stop* button is clicked. The correct count is updated whenever a correct answer is made.



(a) Before a session starts

(b) After a session is started

FIGURE 18.30 The applet tests math skills.

***** 18.27** (*Graphs*) A graph consists of vertices and edges that connect vertices. Write a program that enables the user to draw vertices and edges dynamically, as shown in Figure 18.31. The radius of each vertex is 20 pixels. Implement the following functions: (1) The user clicks the left-mouse button to place a vertex centered at the mouse point, provided that the mouse point is not inside or too

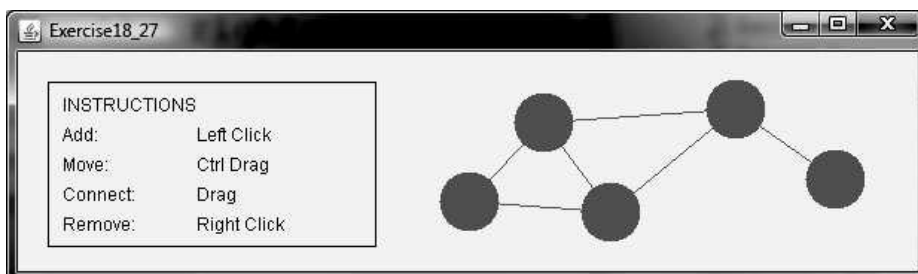


FIGURE 18.31 The applet enables users to draw a graph dynamically.

close to an existing vertex. (2) The user clicks the right-mouse button inside an existing vertex to remove the vertex. (3) The user presses a mouse button inside a vertex and drags to another vertex and then releases the button to create an edge. (4) The user drags a vertex while pressing the *CTRL* key to move a vertex.

**** 18.28** (*Geometry: two circles intersect?*) The `Circle2D` class was defined in Programming Exercise 10.11. Write an applet that enables the user to specify the location and size of the circles and displays whether the two circles intersect, as shown in Figure 18.32a. Enable the user to point the mouse inside a circle and drag it. As the circle is being dragged, the circle's center coordinates in the text fields are updated.

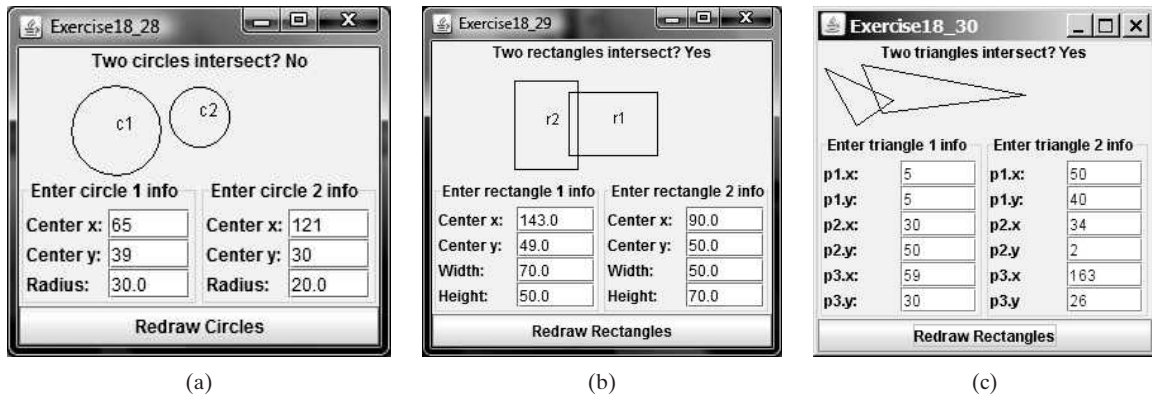


FIGURE 18.32 Check whether two circles, two rectangles, and two triangles are overlapping.

**** 18.29** (*Geometry: two rectangles intersect?*) The `MyRectangle2D` class was defined in Programming Exercise 10.13. Write an applet that enables the user to specify the location and size of the rectangles and displays whether the two rectangles intersect, as shown in Figure 18.32b. Enable the user to point the mouse inside a rectangle and drag it. As the rectangle is being dragged, the rectangle's center coordinates in the text fields are updated.

**** 18.30** (*Geometry: two triangles intersect?*) The `Triangle2D` class was defined in Programming Exercise 10.12. Write an applet that enables the user to specify the location of the two triangles and displays whether the two triangles intersect, as shown in Figure 18.32c.

*** 18.31** (*Count-up stopwatch*) Write an applet that simulates a stopwatch, as shown in Figure 18.33a. When the user clicks the *Start* button, the button's label

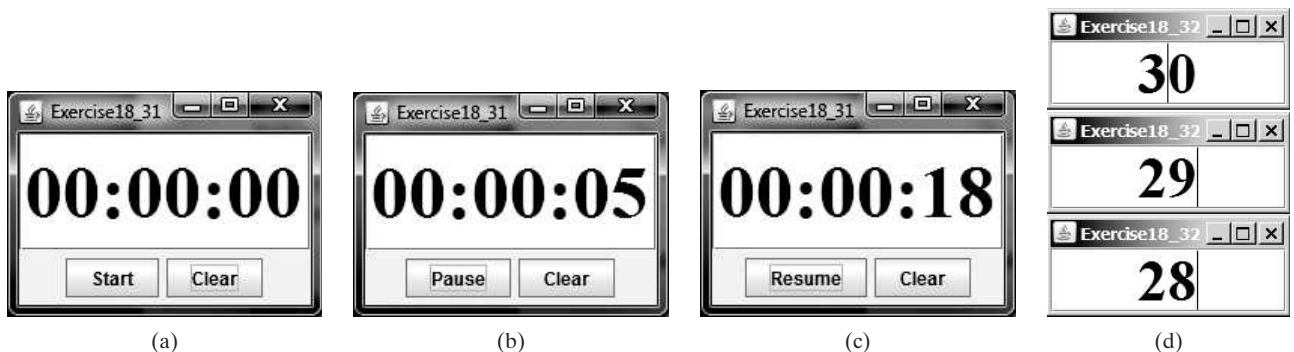


FIGURE 18.33 (a)–(c) The applet counts up the time. (d) The applet counts down the time.

is changed to *Pause*, as shown in Figure 18.33b. When the user clicks the *Pause* button, the button's label is changed to *Resume*, as shown in Figure 18.33c. The *Clear* button resets the count to 0 and resets the button's label to *Start*.

***18.32** (*Count-down stopwatch*) Write an applet that allows the user to enter time in seconds in the text field and press the *Enter* key to count down the minutes, as shown in Figure 18.33(d). The remaining seconds are redisplayed every one second. When the minutes are expired, the program starts to play music continuously.

****18.33** (*Pattern recognition: consecutive four equal numbers*) Write an applet for Programming Exercise 7.19, as shown in Figure 18.34a–b. Let the user enter the numbers in the text fields in a grid of 6 rows and 7 columns. The user can click the *Solve* button to highlight a sequence of four equal numbers, if it exists.

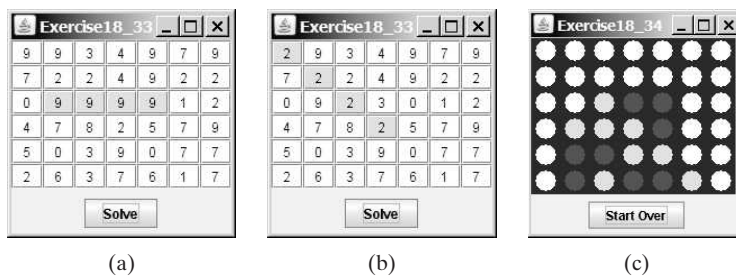


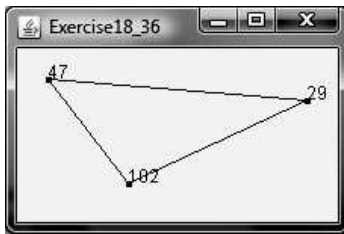
FIGURE 18.34 (a)–(b) Clicking the *Solve* button to highlight the four consecutive numbers in a row, a column, or a diagonal. (c) The applet enables two players to play the connect-four game.

*****18.34** (*Game: connect four*) Programming Exercise 7.20 enables two players to play the connect-four game on the console. Rewrite the program using an applet, as shown in Figure 18.34c. The applet enables two players to place red and yellow discs in turn. To place a disk, the player needs to click on an available cell. An *available cell* is unoccupied and its downward neighbor is occupied. The applet flashes the four winning cells if a player wins and reports no winners if all cells are occupied with no winners.

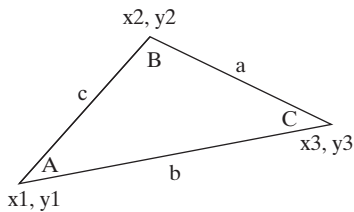
*****18.35** (*Game: play connect four with computer*) Revise Exercise 18.34 to play the game with the computer. The program lets the user make a move first, followed by a move by the computer. The minimum requirement is for the computer to make a legal move. You are encouraged to design good strategies for the computer to make intelligent moves.

****18.36** (*Geometry: display angles*) Write a program that enables the user to drag the vertices of a triangle and displays the angles dynamically as the triangle shape changes, as shown in Figure 18.35a. Change the mouse cursor to the cross-hair shape when the mouse is moved close to a vertex. The formula to compute angles A, B, and C are as follows (see Figure 18.35b):

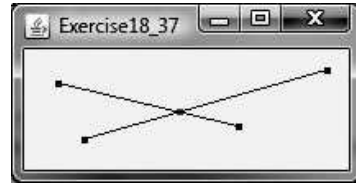
$$\begin{aligned}
 A &= \text{Math.acos}((a * a - b * b - c * c) / (-2 * b * c)) \\
 B &= \text{Math.acos}((b * b - a * a - c * c) / (-2 * a * c)) \\
 C &= \text{Math.acos}((c * c - b * b - a * a) / (-2 * a * b))
 \end{aligned}$$



(a)



(b)



(c)

FIGURE 18.35 (a–b) Exercise18.36 enables the user to drag vertices and display the angles dynamically. (c) Exercise18.37 enables the user to drag vertices and display the lines and their intersecting point dynamically.

****18.37** (*Geometry: intersecting point*) Write a program that displays two line segments with their end points, and their intersecting point. Initially, the end points are at (20, 20) and (56, 130) for line 1 and at (100, 20) and (16, 130) for line 2. The user can use the mouse to drag a point and dynamically display the intersecting point, as shown in Figure 18.35c. *Hint:* See Programming Exercise 3.25 for finding the intersecting point of two unbounded lines.

BINARY I/O

Objectives

- To discover how I/O is processed in Java (§19.2).
- To distinguish between text I/O and binary I/O (§19.3).
- To read and write bytes using `FileInputStream` and `FileOutputStream` (§19.4.1).
- To filter data using the base classes `FilterInputStream` and `FilterOutputStream` (§19.4.2).
- To read and write primitive values and strings using `DataInputStream` and `DataOutputStream` (§19.4.3).
- To improve I/O performance by using `BufferedInputStream` and `BufferedOutputStream` (§19.4.4).
- To write a program that copies a file (§19.5).
- To store and restore objects using `ObjectOutputStream` and `ObjectInputStream` (§19.6).
- To implement the `Serializable` interface to make objects serializable (§19.6.1).
- To serialize arrays (§19.6.2).
- To read and write files using the `RandomAccessFile` class (§19.7).



19.1 Introduction



Java provides many classes for performing text I/O and binary I/O.

text file
binary file

Files can be classified as either text or binary. A file that can be processed (read, created, or modified) using a text editor such as Notepad on Windows or vi on UNIX is called a *text file*. All the other files are called *binary files*. You cannot read binary files using a text editor—they are designed to be read by programs. For example, Java source programs are stored in text files and can be read by a text editor, but Java class files are stored in binary files and are read by the JVM.

why binary I/O?

Although it is not technically precise and correct, you can envision a text file as consisting of a sequence of characters and a binary file as consisting of a sequence of bits. Characters in a text file are encoded using a character encoding scheme such as ASCII or Unicode. For example, the decimal integer **199** is stored as the sequence of the three characters **1**, **9**, **9** in a text file, and the same integer is stored as a byte-type value **C7** in a binary file, because decimal **199** equals hex **C7** ($199 = 12 \times 16^1 + 7$). The advantage of binary files is that they are more efficient to process than text files.

text I/O
binary I/O

Java offers many classes for performing file input and output. These can be categorized as *text I/O classes* and *binary I/O classes*. In Section 14.11, File Input and Output, you learned how to read and write strings and numeric values from/to a text file using **Scanner** and **PrintWriter**. This chapter introduces the classes for performing binary I/O.

19.2 How Is Text I/O Handled in Java?



*Text data is read using the **Scanner** class and written using the **PrintWriter** class.*

Recall that a **File** object encapsulates the properties of a file or a path but does not contain the methods for reading/writing data from/to a file. In order to perform I/O, you need to create objects using appropriate Java I/O classes. The objects contain the methods for reading/writing data from/to a file. For example, to write text to a file named **temp.txt**, you can create an object using the **PrintWriter** class as follows:

```
PrintWriter output = new PrintWriter("temp.txt");
```

You can now invoke the **print** method on the object to write a string to the file. For example, the following statement writes **Java 101** to the file.

```
output.print("Java 101");
```

The next statement closes the file.

```
output.close();
```

There are many I/O classes for various purposes. In general, these can be classified as input classes and output classes. An *input class* contains the methods to read data, and an *output class* contains the methods to write data. **PrintWriter** is an example of an output class, and **Scanner** is an example of an input class. The following code creates an input object for the file **temp.txt** and reads data from the file.

```
Scanner input = new Scanner(new File("temp.txt"));
System.out.println(input.nextLine());
```

If **temp.txt** contains the text **Java 101**, **input.nextLine()** returns the string **"Java 101"**.

Figure 19.1 illustrates Java I/O programming. An input object reads a *stream* of data from a file, and an output object writes a stream of data to a file. An input object is also called an *input stream* and an output object an *output stream*.

stream
input stream
output stream

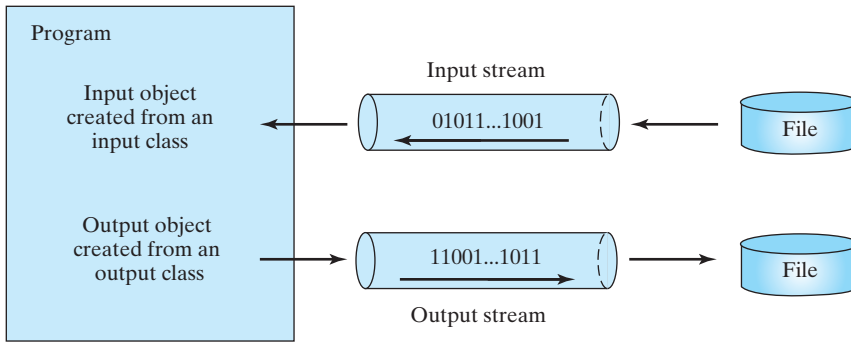


FIGURE 19.1 The program receives data through an input object and sends data through an output object.

19.1 What is a text file, and what is a binary file? Can you view a text file or a binary file using a text editor?

19.2 How do you read or write text data in Java? What is a stream?



MyProgrammingLab™

19.3 Text I/O vs. Binary I/O

Binary I/O does not involve encoding or decoding and thus is more efficient than text I/O.

Computers do not differentiate between binary files and text files. All files are stored in binary format, and thus all files are essentially binary files. Text I/O is built upon binary I/O to provide a level of abstraction for character encoding and decoding, as shown in Figure 19.2a. Encoding and decoding are automatically performed for text I/O. The JVM converts Unicode to a file-specific encoding when writing a character, and it converts a file-specific encoding to Unicode when reading a character. For example, suppose you write the string "199" using text I/O to a file. Each character is written to the file. Since the Unicode for character 1 is 0x0031, the Unicode 0x0031 is converted to a code that depends on the encoding scheme for the file. (Note that the prefix 0x denotes a hex number.) In the United States, the default encoding for text files on Windows is ASCII. The ASCII code for character 1 is 49 (0x31 in

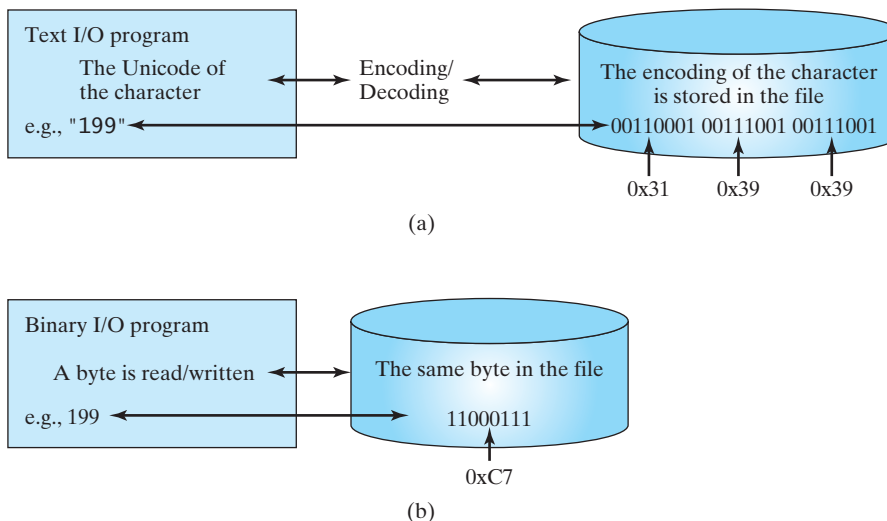


FIGURE 19.2 Text I/O requires encoding and decoding, whereas binary I/O does not.

hex) and for character **9** is **57** (**0x39** in hex). Thus, to write the characters **199**, three bytes—**0x31**, **0x39**, and **0x39**—are sent to the output, as shown in Figure 19.2a.

Binary I/O does not require conversions. If you write a numeric value to a file using binary I/O, the exact value in the memory is copied into the file. For example, a byte-type value **199** is represented as **0xC7** ($199 = 12 \times 16^1 + 7$) in the memory and appears exactly as **0xC7** in the file, as shown in Figure 19.2b. When you read a byte using binary I/O, one byte value is read from the input.

In general, you should use text input to read a file created by a text editor or a text output program, and use binary input to read a file created by a Java binary output program.

Binary I/O is more efficient than text I/O, because binary I/O does not require encoding and decoding. Binary files are independent of the encoding scheme on the host machine and thus are portable. Java programs on any machine can read a binary file created by a Java program. This is why Java class files are binary files. Java class files can run on a JVM on any machine.



Note

For consistency, this book uses the extension **.txt** to name text files and **.dat** to name binary files.

.txt and .dat



MyProgrammingLab™

- 19.3** What are the differences between text I/O and binary I/O?
- 19.4** How is a Java character represented in the memory, and how is a character represented in a text file?
- 19.5** If you write the string **"ABC"** to an ASCII text file, what values are stored in the file?
- 19.6** If you write the string **"100"** to an ASCII text file, what values are stored in the file? If you write a numeric byte-type value **100** using binary I/O, what values are stored in the file?
- 19.7** What is the encoding scheme for representing a character in a Java program? By default, what is the encoding scheme for a text file on Windows?

19.4 Binary I/O Classes



The abstract **InputStream** is the root class for reading binary data and the abstract **OutputStream** is the root class for writing binary data.

The design of the Java I/O classes is a good example of applying inheritance, where common operations are generalized in superclasses, and subclasses provide specialized operations. Figure 19.3 lists some of the classes for performing binary I/O. **InputStream** is the root for

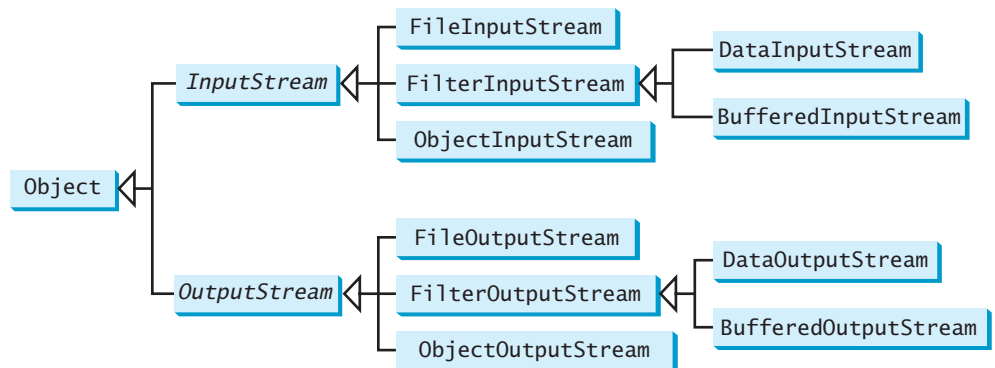


FIGURE 19.3 **InputStream**, **OutputStream**, and their subclasses are for performing binary I/O.

<i>java.io.InputStream</i>	
<code>+read(): int</code>	Reads the next byte of data from the input stream. The value byte is returned as an <code>int</code> value in the range 0 to 255. If no byte is available because the end of the stream has been reached, the value <code>-1</code> is returned.
<code>+read(b: byte[]): int</code>	Reads up to <code>b.length</code> bytes into array <code>b</code> from the input stream and returns the actual number of bytes read. Returns <code>-1</code> at the end of the stream.
<code>+read(b: byte[], off: int, len: int): int</code>	Reads bytes from the input stream and stores them in <code>b[off]</code> , <code>b[off+1]</code> , . . . , <code>b[off+len-1]</code> . The actual number of bytes read is returned. Returns <code>-1</code> at the end of the stream.
<code>+available(): int</code>	Returns an estimate of the number of bytes that can be read from the input stream.
<code>+close(): void</code>	Closes this input stream and releases any system resources occupied by it.
<code>+skip(n: long): long</code>	Skips over and discards <code>n</code> bytes of data from this input stream. The actual number of bytes skipped is returned.
<code>+markSupported(): boolean</code>	Tests whether this input stream supports the <code>mark</code> and <code>reset</code> methods.
<code>+mark(readLimit: int): void</code>	Marks the current position in this input stream.
<code>+reset(): void</code>	Repositions this stream to the position at the time the <code>mark</code> method was last called on this input stream.

FIGURE 19.4 The abstract `InputStream` class defines the methods for the input stream of bytes.

binary input classes, and `OutputStream` is the root for binary output classes. Figures 19.4 and 19.5 list all the methods in the classes `InputStream` and `OutputStream`.



Note

All the methods in the binary I/O classes are declared to throw `java.io.IOException` or a subclass of `java.io.IOException`.

throws `IOException`

<i>java.io.OutputStream</i>	
<code>+write(int b): void</code>	Writes the specified byte to this output stream. The parameter <code>b</code> is an <code>int</code> value. (byte) <code>b</code> is written to the output stream.
<code>+write(b: byte[]): void</code>	Writes all the bytes in array <code>b</code> to the output stream.
<code>+write(b: byte[], off: int, len: int): void</code>	Writes <code>b[off]</code> , <code>b[off+1]</code> , . . . , <code>b[off+len-1]</code> into the output stream.
<code>+close(): void</code>	Closes this output stream and releases any system resources occupied by it.
<code>+flush(): void</code>	Flushes this output stream and forces any buffered output bytes to be written out.

FIGURE 19.5 The abstract `OutputStream` class defines the methods for the output stream of bytes.

19.4.1 FileInputStream/FileOutputStream

`FileInputStream/FileOutputStream` is for reading/writing bytes from/to files. All the methods in these classes are inherited from `InputStream` and `OutputStream`. `FileInputStream/FileOutputStream` does not introduce new methods. To construct a `FileInputStream`, use the constructors shown in Figure 19.6.

A `java.io.FileNotFoundException` will occur if you attempt to create a `FileInputStream` with a nonexistent file.

`FileNotFoundException`

To construct a `FileOutputStream`, use the constructors shown in Figure 19.7.

If the file does not exist, a new file will be created. If the file already exists, the first two constructors will delete the current content of the file. To retain the current content and append new data into the file, use the last two constructors and pass `true` to the `append` parameter.

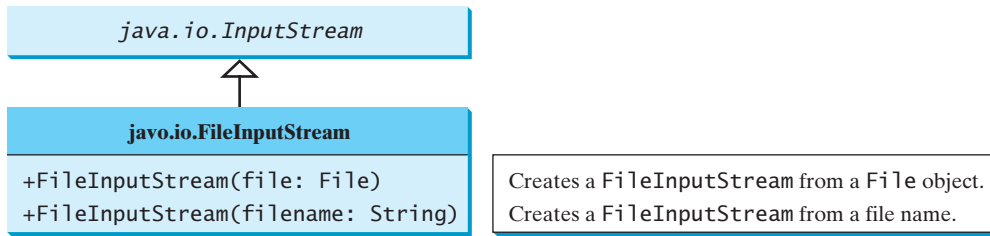


FIGURE 19.6 `FileInputStream` inputs a stream of bytes from a file.

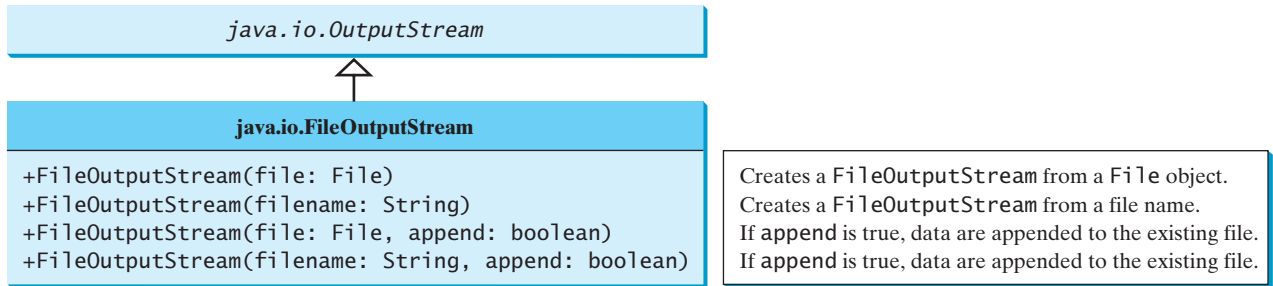


FIGURE 19.7 `FileOutputStream` outputs a stream of bytes to a file.

`IOException`

Almost all the methods in the I/O classes throw `java.io.IOException`. Therefore, you have to declare `java.io.IOException` to throw in the method or place the code in a try-catch block, as shown below:

Declaring exception in the method

```
public static void main(String[] args)
    throws IOException {
    // Perform I/O operations
}
```

Using try-catch block

```
public static void main(String[] args) {
    try {
        // Perform I/O operations
    }
    catch (IOException ex) {
        ex.printStackTrace();
    }
}
```

Listing 19.1 uses binary I/O to write ten byte values from 1 to 10 to a file named `temp.dat` and reads them back from the file.

LISTING 19.1 `TestFileStream.java`

```
import          1  import java.io.*;
                2
                3  public class TestFileStream {
output stream   4      public static void main(String[] args) throws IOException {
                5          // Create an output stream to the file
                6          FileOutputStream output = new FileOutputStream("temp.dat");
                7
                8          // Output values to the file
output          9          for (int i = 1; i <= 10; i++)
                10             output.write(i);
                11
                12             // Close the output stream
                13             output.close();
                14
```

```

15 // Create an input stream for the file
16 FileInputStream input = new FileInputStream("temp.dat");
17
18 // Read values from the file
19 int value;
20 while ((value = input.read()) != -1)
21     System.out.print(value + " ");
22
23 // Close the output stream
24 input.close();
25 }
26 }

```

input stream
input

```
1 2 3 4 5 6 7 8 9 10
```



A `FileOutputStream` is created for the file `temp.dat` in line 6. The `for` loop writes ten byte values into the file (lines 9–10). Invoking `write(i)` is the same as invoking `write((byte)i)`. Line 13 closes the output stream. Line 16 creates a `FileInputStream` for the file `temp.dat`. Values are read from the file and displayed on the console in lines 19–21. The expression `((value = input.read()) != -1)` (line 20) reads a byte from `input.read()`, assigns it to `value`, and checks whether it is `-1`. The input value of `-1` signifies the end of a file.

end of a file

The file `temp.dat` created in this example is a binary file. It can be read from a Java program but not from a text editor, as shown in Figure 19.8.



FIGURE 19.8 A binary file cannot be displayed in text mode.



Tip

When a stream is no longer needed, always close it using the `close()` method. Not closing streams may cause data corruption in the output file, or other programming errors.

close stream



Note

The root directory for the file is the classpath directory. For the example in this book, the root directory is `c:\book`, so the file `temp.dat` is located at `c:\book`. If you wish to place `temp.dat` in a specific directory, replace line 6 with

where is the file?

```
FileOutputStream output =
    new FileOutputStream ("directory/temp.dat");
```



Note

An instance of `FileInputStream` can be used as an argument to construct a `Scanner`, and an instance of `FileOutputStream` can be used as an argument to construct a `PrintWriter`. You can create a `PrintWriter` to append text into a file using

appending to text file

```
new PrintWriter(new FileOutputStream("temp.txt", true));
```

If **temp.txt** does not exist, it is created. If **temp.txt** already exists, new data are appended to the file.

19.4.2 FilterInputStream/FilterOutputStream

Filter streams are streams that filter bytes for some purpose. The basic byte input stream provides a **read** method that can be used only for reading bytes. If you want to read integers, doubles, or strings, you need a filter class to wrap the byte input stream. Using a filter class enables you to read integers, doubles, and strings instead of bytes and characters. **FilterInputStream** and **FilterOutputStream** are the base classes for filtering data. When you need to process primitive numeric types, use **DataInputStream** and **DataOutputStream** to filter bytes.

19.4.3 DataInputStream/DataOutputStream

DataInputStream reads bytes from the stream and converts them into appropriate primitive type values or strings. **DataOutputStream** converts primitive type values or strings into bytes and outputs the bytes to the stream.

DataInputStream extends **FilterInputStream** and implements the **DataInput** interface, as shown in Figure 19.9. **DataOutputStream** extends **FilterOutputStream** and implements the **DataOutput** interface, as shown in Figure 19.10.

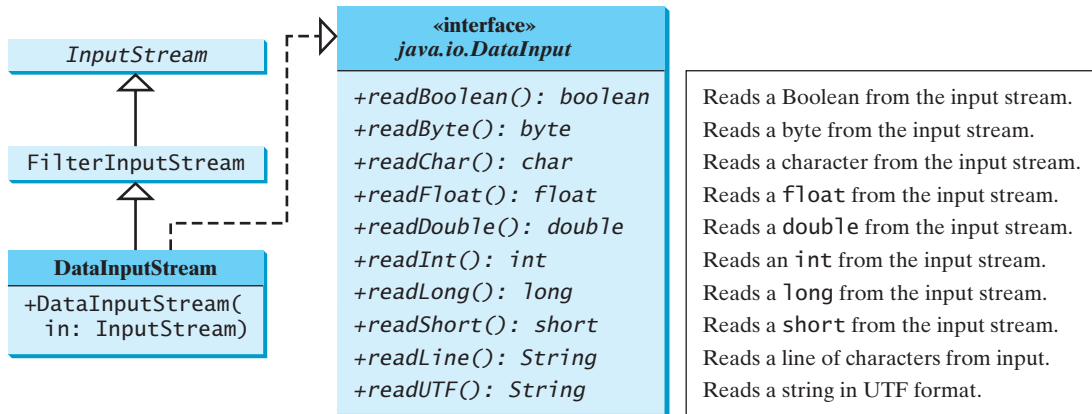


FIGURE 19.9 **DataInputStream** filters an input stream of bytes into primitive data type values and strings.

DataInputStream implements the methods defined in the **DataInput** interface to read primitive data type values and strings. **DataOutputStream** implements the methods defined in the **DataOutput** interface to write primitive data type values and strings. Primitive values are copied from memory to the output without any conversions. Characters in a string may be written in several ways, as discussed in the next section.

Characters and Strings in Binary I/O

A Unicode character consists of two bytes. The **writeChar(char c)** method writes the Unicode of character **c** to the output. The **writeChars(String s)** method writes the Unicode for each character in the string **s** to the output. The **writeBytes(String s)** method writes the lower byte of the Unicode for each character in the string **s** to the output. The high byte of the Unicode is discarded. The **writeBytes** method is suitable for strings that consist

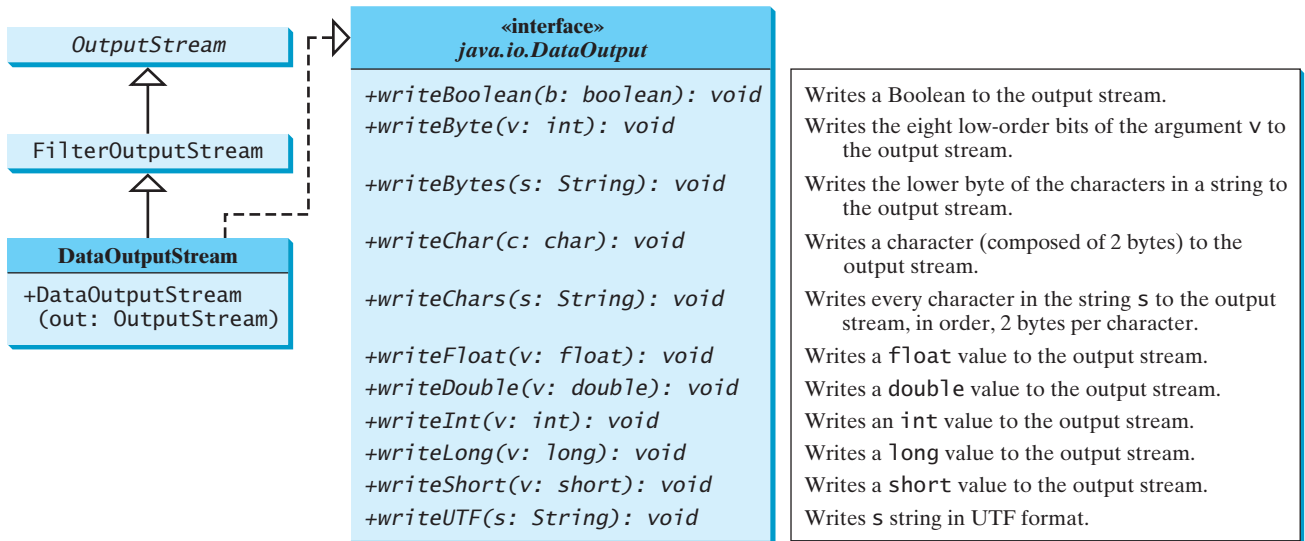


FIGURE 19.10 `DataOutputStream` enables you to write primitive data type values and strings into an output stream.

of ASCII characters, since an ASCII code is stored only in the lower byte of a Unicode. If a string consists of non-ASCII characters, you have to use the `writeChars` method to write the string.

The `writeUTF(String s)` method writes two bytes of length information to the output stream, followed by the modified UTF-8 representation of every character in the string `s`. UTF-8 is a coding scheme that allows systems to operate with both ASCII and Unicode. Most operating systems use ASCII. Java uses Unicode. The ASCII character set is a subset of the Unicode character set. Since most applications need only the ASCII character set, it is a waste to represent an 8-bit ASCII character as a 16-bit Unicode character. The modified UTF-8 scheme stores a character using one, two, or three bytes. Characters are coded in one byte if their code is less than or equal to `0x7F`, in two bytes if their code is greater than `0x7F` and less than or equal to `0x7FF`, or in three bytes if their code is greater than `0x7FF`.

The initial bits of a UTF-8 character indicate whether a character is stored in one byte, two bytes, or three bytes. If the first bit is `0`, it is a one-byte character. If the first bits are `110`, it is the first byte of a two-byte sequence. If the first bits are `1110`, it is the first byte of a three-byte sequence. The information that indicates the number of characters in a string is stored in the first two bytes preceding the UTF-8 characters. For example, `writeUTF("ABCDEF")` actually writes eight bytes (i.e., `00 06 41 42 43 44 45 46`) to the file, because the first two bytes store the number of characters in the string.

The `writeUTF(String s)` method converts a string into a series of bytes in the UTF-8 format and writes them into an output stream. The `readUTF()` method reads a string that has been written using the `writeUTF` method.

The UTF-8 format has the advantage of saving a byte for each ASCII character, because a Unicode character takes up two bytes and an ASCII character in UTF-8 only one byte. If most of the characters in a long string are regular ASCII characters, using UTF-8 is more efficient.

Creating `DataInputStream/DataOutputStream`

`DataInputStream/DataOutputStream` are created using the following constructors (see Figures 19.9 and 19.10):

```

public DataInputStream(InputStream instream)
public DataOutputStream(OutputStream outstream)
  
```

UTF-8 scheme

The following statements create data streams. The first statement creates an input stream for the file **in.dat**; the second statement creates an output stream for the file **out.dat**.

```
DataInputStream input =
    new DataInputStream(new FileInputStream("in.dat"));
DataOutputStream output =
    new DataOutputStream(new FileOutputStream("out.dat"));
```

Listing 19.2 writes student names and scores to a file named **temp.dat** and reads the data back from the file.

LISTING 19.2 TestDataStream.java

```
1  import java.io.*;
2
3  public class TestDataStream {
4      public static void main(String[] args) throws IOException {
5          // Create an output stream for file temp.dat
6          DataOutputStream output =
7              new DataOutputStream(new FileOutputStream("temp.dat"));
8
9          // Write student test scores to the file
10         output.writeUTF("John");
11         output.writeDouble(85.5);
12         output.writeUTF("Susan");
13         output.writeDouble(185.5);
14         output.writeUTF("Kim");
15         output.writeDouble(105.25);
16
17         // Close output stream
18         output.close();
19
20         // Create an input stream for file temp.dat
21         DataInputStream input =
22             new DataInputStream(new FileInputStream("temp.dat"));
23
24         // Read student test scores from the file
25         System.out.println(input.readUTF() + " " + input.readDouble());
26         System.out.println(input.readUTF() + " " + input.readDouble());
27         System.out.println(input.readUTF() + " " + input.readDouble());
28     }
29 }
```

output stream

output

close stream

input stream

input



```
John 85.5
Susan 185.5
Kim 105.25
```

A **DataOutputStream** is created for file **temp.dat** in lines 6–7. Student names and scores are written to the file in lines 10–15. Line 18 closes the output stream. A **DataInputStream** is created for the same file in lines 21–22. Student names and scores are read back from the file and displayed on the console in lines 25–27.

DataInputStream and **DataOutputStream** read and write Java primitive type values and strings in a machine-independent fashion, thereby enabling you to write a data file on one machine and read it on another machine that has a different operating system or file structure. An application uses a data output stream to write data that can later be read by a program using a data input stream.

**Caution**

You have to read data in the same order and format in which they are stored. For example, since names are written in UTF-8 using `writeUTF`, you must read names using `readUTF`.

Detecting the End of a File

If you keep reading data at the end of an `InputStream`, an `EOFException` will occur. This `EOFException` exception can be used to detect the end of a file, as shown in Listing 19.3.

LISTING 19.3 DetectEndOfFile.java

```

1  import java.io.*;
2
3  public class DetectEndOfFile {
4      public static void main(String[] args) {
5          try {
6              DataOutputStream output =                output stream
7                  new DataOutputStream(new FileOutputStream("test.dat"));
8                  output.writeDouble(4.5);             output
9                  output.writeDouble(43.25);
10                 output.writeDouble(3.2);
11                 output.close();                       close stream
12
13                 DataInputStream input =              input stream
14                     new DataInputStream(new FileInputStream("test.dat"));
15                 while (true) {
16                     System.out.println(input.readDouble());    input
17                 }
18             }
19             catch (EOFException ex) {                 EOFException
20                 System.out.println("All data were read");
21             }
22             catch (IOException ex) {
23                 ex.printStackTrace();
24             }
25         }
26     }

```

```

4.5
43.25
3.2
All data were read

```



The program writes three double values to the file using `DataOutputStream` (lines 6–10), and reads the data using `DataInputStream` (lines 13–14). When reading past the end of the file, an `EOFException` is thrown. The exception is caught in line 19.

19.4.4 BufferedInputStream/BufferedOutputStream

`BufferedInputStream/BufferedOutputStream` can be used to speed up input and output by reducing the number of disk reads and writes. Using `BufferedInputStream`, the whole block of data on the disk is read into the buffer in the memory once. The individual data are then delivered to your program from the buffer, as shown in Figure 19.11a. Using `BufferedOutputStream`, the individual data are first written to the buffer in the memory. When the buffer is full, all data in the buffer is written to the disk once, as shown in Figure 19.11b.

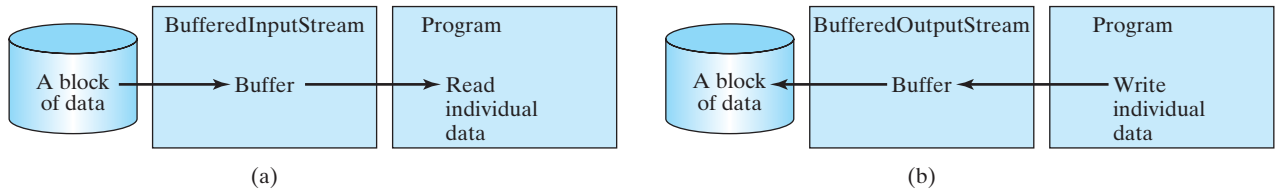


FIGURE 19.11 Buffer I/O places data in a buffer for fast processing.

BufferedInputStream/BufferedOutputStream does not contain new methods. All the methods in **BufferedInputStream/BufferedOutputStream** are inherited from the **InputStream/OutputStream** classes. **BufferedInputStream/BufferedOutputStream** manages a buffer behind the scene and automatically reads/writes data from/to disk on demand.

You can wrap a **BufferedInputStream/BufferedOutputStream** on any **InputStream/OutputStream** using the constructors shown in Figures 19.12 and 19.13.

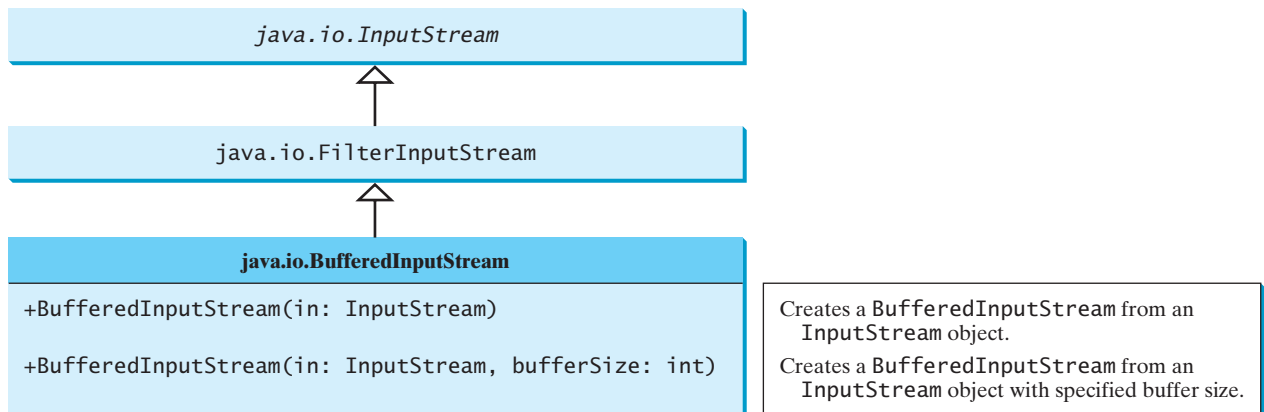


FIGURE 19.12 **BufferedInputStream** buffers an input stream.

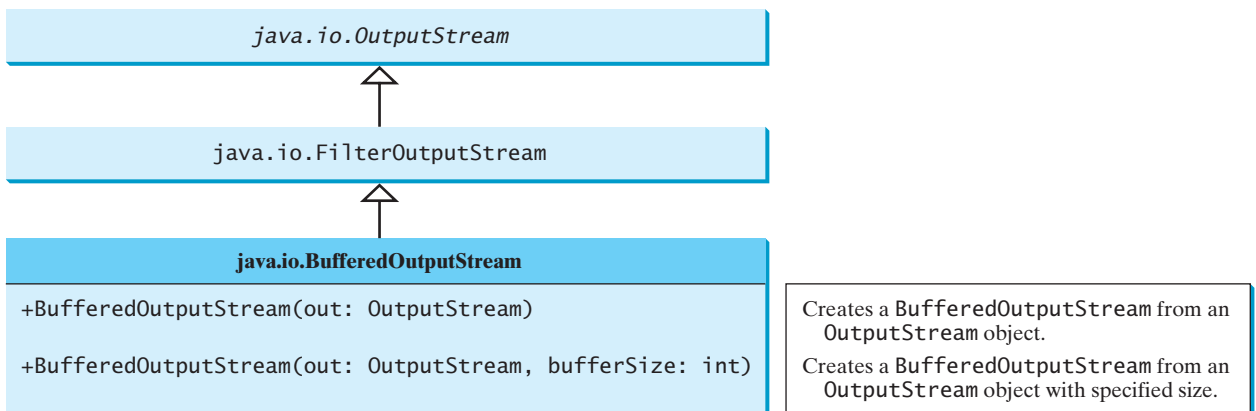


FIGURE 19.13 **BufferedOutputStream** buffers an output stream.

If no buffer size is specified, the default size is **512** bytes. You can improve the performance of the **TestDataStream** program in Listing 19.2 by adding buffers in the stream in lines 6–7 and 21–22, as follows:

```
DataOutputStream output = new DataOutputStream(
    new BufferedOutputStream(new FileOutputStream("temp.dat")));

DataInputStream input = new DataInputStream(
    new BufferedInputStream(new FileInputStream("temp.dat")));
```



Tip

You should always use buffered I/O to speed up input and output. For small files, you may not notice performance improvements. However, for large files—over 100 MB—you will see substantial improvements using buffered I/O.

- 19.8** Why do you have to declare to throw **IOException** in the method or use a try-catch block to handle **IOException** for Java I/O programs?
- 19.9** Why should you always close streams?
- 19.10** The **read()** method in **InputStream** reads a byte. Why does it return an **int** instead of a **byte**? Find the abstract methods in **InputStream** and **OutputStream**.
- 19.11** Does **FileInputStream/FileOutputStream** introduce any new methods beyond the methods inherited from **InputStream/OutputStream**? How do you create a **FileInputStream/FileOutputStream**?
- 19.12** What will happen if you attempt to create an input stream on a nonexistent file? What will happen if you attempt to create an output stream on an existing file? Can you append data to an existing file?
- 19.13** How do you append data to an existing text file using **java.io.PrintWriter**?
- 19.14** Suppose a file contains an unspecified number of **double** values. These values were written to the file using the **writeDouble** method using a **DataOutputStream**. How do you write a program to read all these values? How do you detect the end of a file?
- 19.15** What is written to a file using **writeByte(91)** on a **FileOutputStream**?
- 19.16** How do you check the end of a file in an input stream (**FileInputStream, DataInputStream**)?
- 19.17** What is wrong in the following code?

```
import java.io.*;

public class Test {
    public static void main(String[] args) {
        try {
            FileInputStream fis = new FileInputStream("test.dat");
        }
        catch (IOException ex) {
            ex.printStackTrace();
        }
        catch (FileNotFoundException ex) {
            ex.printStackTrace();
        }
    }
}
```

- 19.18** Suppose you run the program on Windows using the default ASCII encoding. After the program is finished, how many bytes are in the file **t.txt**? Show the contents of each byte.



MyProgrammingLab™

```

public class Test {
    public static void main(String[] args)
        throws java.io.IOException {
        java.io.PrintWriter output =
            new java.io.PrintWriter("t.txt");
        output.printf("%s", "1234");
        output.printf("%s", "5678");
        output.close();
    }
}

```

- 19.19** After the program is finished, how many bytes are in the file `t.dat`? Show the contents of each byte.

```

import java.io.*;

public class Test {
    public static void main(String[] args) throws IOException {
        DataOutputStream output = new DataOutputStream(
            new FileOutputStream("t.dat"));
        output.writeInt(1234);
        output.writeInt(5678);
        output.close();
    }
}

```

- 19.20** For each of the following statements on a `DataOutputStream output`, how many bytes are sent to the output?

```

output.writeChar('A');
output.writeChars("BC");
output.writeUTF("DEF");

```

- 19.21** What are the advantages of using buffered streams? Are the following statements correct?

```

BufferedInputStream input1 =
    new BufferedInputStream(new FileInputStream("t.dat"));

DataInputStream input2 = new DataInputStream(
    new BufferedInputStream(new FileInputStream("t.dat")));

ObjectInputStream input3 = new ObjectInputStream(
    new BufferedInputStream(new FileInputStream("t.dat")));

```

19.5 Case Study: Copying Files



Key
Point

This section develops a useful utility for copying files.

In this section, you will learn how to write a program that lets users copy files. The user needs to provide a source file and a target file as command-line arguments using the command:

```
java Copy source target
```

The program copies the source file to the target file and displays the number of bytes in the file. The program should alert the user if the source file does not exist or if the target file already exists. A sample run of the program is shown in Figure 19.14.



VideoNote

Copy file

```

Administrator: Command Prompt
c:\book>java Copy Welcome.java Temp.java
Target file Temp.java already exists

c:\book>del Temp.java

c:\book>java Copy Welcome.java Temp.java
176 bytes copied

c:\book>java Copy TTT.java Temp.java
Source file TTT.java does not exist

c:\book>

```

FIGURE 19.14 The program copies a file.

To copy the contents from a source file to a target file, it is appropriate to use an input stream to read bytes from the source file and an output stream to send bytes to the target file, regardless of the file's contents. The source file and the target file are specified from the command line. Create an `InputStream` for the source file and an `OutputStream` for the target file. Use the `read()` method to read a byte from the input stream, and then use the `write(b)` method to write the byte to the output stream. Use `BufferedInputStream` and `BufferedOutputStream` to improve the performance. Listing 19.4 gives the solution to the problem.

LISTING 19.4 Copy.java

```

1  import java.io.*;
2
3  public class Copy {
4      /** Main method
5          @param args[0] for source file
6          @param args[1] for target file
7      */
8      public static void main(String[] args) throws IOException {
9          // Check command-line parameter usage
10         if (args.length != 2) {                                check usage
11             System.out.println(
12                 "Usage: java Copy sourceFile targetFile");
13             System.exit(1);
14         }
15
16         // Check whether source file exists
17         File sourceFile = new File(args[0]);                    source file
18         if (!sourceFile.exists()) {
19             System.out.println("Source file " + args[0]
20                 + " does not exist");
21             System.exit(2);
22         }
23
24         // Check whether target file exists
25         File targetFile = new File(args[1]);                    target file
26         if (targetFile.exists()) {
27             System.out.println("Target file " + args[1]
28                 + " already exists");
29             System.exit(3);
30         }
31
32         // Create an input stream
33         BufferedInputStream input =                            input stream

```

```

34         new BufferedInputStream(new FileInputStream(sourceFile));
35
36         // Create an output stream
37         BufferedOutputStream output =
38             new BufferedOutputStream(new FileOutputStream(targetFile));
39
40         // Continuously read a byte from input and write it to output
41         int r, numberOfBytesCopied = 0;
42         while ((r = input.read()) != -1) {
43             output.write((byte)r);
44             numberOfBytesCopied++;
45         }
46
47         // Close streams
48         input.close();
49         output.close();
50
51         // Display the file size
52         System.out.println(numberOfBytesCopied + " bytes copied");
53     }
54 }

```

output stream

read
write

close stream

The program first checks whether the user has passed the two required arguments from the command line in lines 10–14.

The program uses the `File` class to check whether the source file and target file exist. If the source file does not exist (lines 18–22) or if the target file already exists (lines 25–30), the program ends.

An input stream is created using `BufferedInputStream` wrapped on `FileInputStream` in lines 33–34, and an output stream is created using `BufferedOutputStream` wrapped on `FileOutputStream` in lines 37–38.

The expression `((r = input.read()) != -1)` (line 42) reads a byte from `input.read()`, assigns it to `r`, and checks whether it is `-1`. The input value of `-1` signifies the end of a file. The program continuously reads bytes from the input stream and sends them to the output stream until all of the bytes have been read.



19.22 How does the program check if a file already exists?

19.23 How does the program detect the end of the file while reading data?

19.24 How does the program count the number of bytes read from the file?

MyProgrammingLab™

19.6 Object I/O



`ObjectInputStream/ObjectOutputStream` classes can be used to read/write serializable objects.

`DataInputStream/DataOutputStream` enables you to perform I/O for primitive type values and strings. `ObjectInputStream/ObjectOutputStream` enables you to perform I/O for objects in addition to primitive type values and strings. Since `ObjectInputStream/ObjectOutputStream` contains all the functions of `DataInputStream/DataOutputStream`, you can replace `DataInputStream/DataOutputStream` completely with `ObjectInputStream/ObjectOutputStream`.

`ObjectInputStream` extends `InputStream` and implements `ObjectInput` and `ObjectStreamConstants`, as shown in Figure 19.15. `ObjectInput` is a subinterface of `DataInput` (`DataInput` is shown in Figure 19.9). `ObjectStreamConstants` contains the constants to support `ObjectInputStream/ObjectOutputStream`.



VideoNote
Object I/O

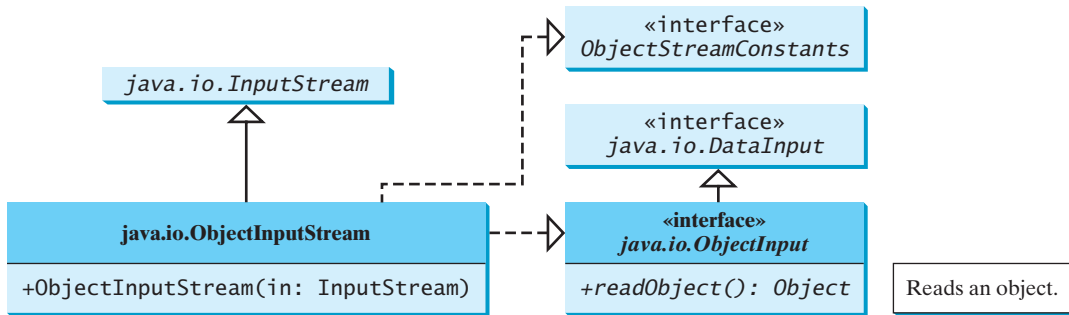


FIGURE 19.15 `ObjectInputStream` can read objects, primitive type values, and strings.

`ObjectOutputStream` extends `OutputStream` and implements `ObjectOutput` and `ObjectStreamConstants`, as shown in Figure 19.16. `ObjectOutput` is a subinterface of `DataOutput` (`DataOutput` is shown in Figure 19.10).

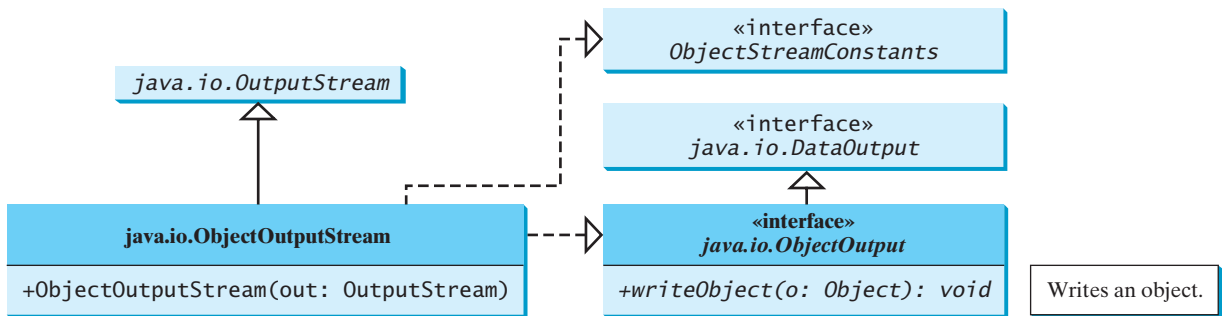


FIGURE 19.16 `ObjectOutputStream` can write objects, primitive type values, and strings.

You can wrap an `ObjectInputStream/ObjectOutputStream` on any `InputStream/OutputStream` using the following constructors:

```

// Create an ObjectInputStream
public ObjectInputStream(InputStream in)

// Create an ObjectOutputStream
public ObjectOutputStream(OutputStream out)
  
```

Listing 19.5 writes student names, scores, and the current date to a file named `object.dat`.

LISTING 19.5 TestObjectOutputStream.java

```

1 import java.io.*;
2
3 public class TestObjectOutputStream {
4     public static void main(String[] args) throws IOException {
5         // Create an output stream for file object.dat
6         ObjectOutputStream output =
7             new ObjectOutputStream(new FileOutputStream("object.dat"));
8
9         // Write a string, double value, and object to the file
  
```

output stream

```

output      10      output.writeUTF("John");
            11      output.writeDouble(85.5);
            12      output.writeObject(new java.util.Date());
            13
            14      // Close output stream
            15      output.close();
            16  }
            17  }

```

An `ObjectOutputStream` is created to write data into the file `object.dat` in lines 6–7. A string, a double value, and an object are written to the file in lines 10–12. To improve performance, you may add a buffer in the stream using the following statement to replace lines 6–7:

```

ObjectOutputStream output = new ObjectOutputStream(
    new BufferedOutputStream(new FileOutputStream("object.dat")));

```

Multiple objects or primitives can be written to the stream. The objects must be read back from the corresponding `ObjectInputStream` with the same types and in the same order as they were written. Java’s safe casting should be used to get the desired type. Listing 19.6 reads data from `object.dat`.

LISTING 19.6 TestObjectInputStream.java

```

input stream 1  import java.io.*;
              2
              3  public class TestObjectInputStream {
              4      public static void main(String[] args)
              5          throws ClassNotFoundException, IOException {
              6          // Create an input stream for file object.dat
              7          ObjectInputStream input =
              8              new ObjectInputStream(new FileInputStream("object.dat"));
              9
              10         // Write a string, double value, and object to the file
              11         String name = input.readUTF();
              12         double score = input.readDouble();
              13         java.util.Date date = (java.util.Date)(input.readObject());
              14         System.out.println(name + " " + score + " " + date);
              15
              16         // Close input stream
              17         input.close();
              18     }
              19 }

```



```
John 85.5 Sun Dec 04 10:35:31 EST 2011
```

`ClassNotFoundException`

The `readObject()` method may throw `java.lang.ClassNotFoundException`, because when the JVM restores an object, it first loads the class for the object if the class has not been loaded. Since `ClassNotFoundException` is a checked exception, the `main` method declares to throw it in line 5. An `ObjectInputStream` is created to read input from `object.dat` in lines 7–8. You have to read the data from the file in the same order and format as they were written to the file. A string, a double value, and an object are read in lines 11–13. Since `readObject()` returns an `Object`, it is cast into `Date` and assigned to a `Date` variable in line 13.

19.6.1 The `Serializable` Interface

Not every object can be written to an output stream. Objects that can be so written are said to be *serializable*. A serializable object is an instance of the `java.io.Serializable` interface, so the object's class must implement `Serializable`.

serializable

The `Serializable` interface is a marker interface. Since it has no methods, you don't need to add additional code in your class that implements `Serializable`. Implementing this interface enables the Java serialization mechanism to automate the process of storing objects and arrays.

To appreciate this automation feature, consider what you otherwise need to do in order to store an object. Suppose you want to store a `JButton` object. To do this you need to store all the current values of the properties (e.g., color, font, text, alignment) in the object. Since `JButton` is a subclass of `AbstractButton`, the property values of `AbstractButton` have to be stored as well as the properties of all the superclasses of `AbstractButton`. If a property is of an object type (e.g., `background` of the `Color` type), storing it requires storing all the property values inside this object. As you can see, this would be a very tedious process. Fortunately, you don't have to go through it manually. Java provides a built-in mechanism to automate the process of writing objects. This process is referred to as *object serialization*, which is implemented in `ObjectOutputStream`. In contrast, the process of reading objects is referred to as *object deserialization*, which is implemented in `ObjectInputStream`.

serialization

deserialization

Many classes in the Java API implement `Serializable`. The utility classes, such as `java.util.Date`, and all the Swing GUI component classes implement `Serializable`. Attempting to store an object that does not support the `Serializable` interface would cause a `NotSerializableException`.

NotSerializableException

When a serializable object is stored, the class of the object is encoded; this includes the class name and the signature of the class, the values of the object's instance variables, and the closure of any other objects referenced by the object. The values of the object's static variables are not stored.



Note

nonserializable fields

If an object is an instance of `Serializable` but contains nonserializable instance data fields, can it be serialized? The answer is no. To enable the object to be serialized, mark these data fields with the `transient` keyword to tell the JVM to ignore them when writing the object to an object stream. Consider the following class:

transient

```
public class C implements java.io.Serializable {
    private int v1;
    private static double v2;
    private transient A v3 = new A();
}
```

```
class A { } // A is not serializable
```

When an object of the `C` class is serialized, only variable `v1` is serialized. Variable `v2` is not serialized because it is a static variable, and variable `v3` is not serialized because it is marked `transient`. If `v3` were not marked `transient`, a `java.io.NotSerializableException` would occur.



Note

duplicate objects

If an object is written in an object stream more than once, will it be stored in multiple copies? No, it will not. When an object is written for the first time, a serial number is created for it. The JVM writes the complete contents of the object along with the serial

number into the object stream. After the first time, only the serial number is stored if the same object is written again. When the objects are read back, their references are the same, since only one object is actually created in the memory.

19.6.2 Serializing Arrays

An array is serializable if all its elements are serializable. An entire array can be saved into a file using `writeObject` and later can be restored using `readObject`. Listing 19.7 stores an array of five `int` values and an array of three strings and reads them back to display on the console.

LISTING 19.7 TestObjectStreamForArray.java

```

1  import java.io.*;
2
3  public class TestObjectStreamForArray {
4      public static void main(String[] args)
5          throws ClassNotFoundException, IOException {
6          int[] numbers = {1, 2, 3, 4, 5};
7          String[] strings = {"John", "Susan", "Kim"};
8
9          // Create an output stream for file array.dat
10         ObjectOutputStream output = new ObjectOutputStream(new
11             FileOutputStream("array.dat", true));
12
13         // Write arrays to the object output stream
14         output.writeObject(numbers);
15         output.writeObject(strings);
16
17         // Close the stream
18         output.close();
19
20         // Create an input stream for file array.dat
21         ObjectInputStream input =
22             new ObjectInputStream(new FileInputStream("array.dat"));
23
24         int[] newNumbers = (int[])input.readObject();
25         String[] newStrings = (String[])input.readObject();
26
27         // Display arrays
28         for (int i = 0; i < newNumbers.length; i++)
29             System.out.print(newNumbers[i] + " ");
30         System.out.println();
31
32         for (int i = 0; i < newStrings.length; i++)
33             System.out.print(newStrings[i] + " ");
34
35         // Close the stream
36         input.close();
37     }
38 }

```

output stream

store array

input stream

restore array



```

1 2 3 4 5
John Susan Kim

```

Lines 14–15 write two arrays into file `array.dat`. Lines 24–25 read two arrays back in the same order they were written. Since `readObject()` returns `Object`, casting is used to cast the objects into `int[]` and `String[]`.

- 19.25** What types of objects can be stored using the `ObjectOutputStream`? What is the method for writing an object? What is the method for reading an object? What is the return type of the method that reads an object from `ObjectInputStream`?
- 19.26** If you serialize two objects of the same type, will they take the same amount of space? If not, give an example.
- 19.27** Is it true that any instance of `java.io.Serializable` can be successfully serialized? Are the static variables in an object serialized? How do you mark an instance variable not to be serialized?
- 19.28** Can you write an array to an `ObjectOutputStream`?
- 19.29** Is it true that `DataInputStream/DataOutputStream` can always be replaced by `ObjectInputStream/ObjectOutputStream`?
- 19.30** What will happen when you attempt to run the following code?

```
import java.io.*;

public class Test {
    public static void main(String[] args) throws IOException {
        ObjectOutputStream output =
            new ObjectOutputStream(new FileOutputStream("object.dat"));

        output.writeObject(new A());
    }
}

class A implements Serializable {
    B b = new B();
}

class B {
}
```



19.7 Random-Access Files

Java provides the `RandomAccessFile` class to allow a file to be read from and written to at random locations.

All of the streams you have used so far are known as *read-only* or *write-only* streams. The external files of these streams are *sequential* files that cannot be updated without creating a new file. However, it is often necessary to modify files. Java provides the `RandomAccessFile` class to allow a file to be read from and written to at *random* locations.

The `RandomAccessFile` class implements the `DataInput` and `DataOutput` interfaces, as shown in Figure 19.17. The `DataInput` interface (see Figure 19.9) defines the methods for reading primitive type values and strings (e.g., `readInt`, `readDouble`, `readChar`, `readBoolean`, `readUTF`), and the `DataOutput` interface (see Figure 19.10) defines the methods for writing primitive type values and strings (e.g., `writeInt`, `writeDouble`, `writeChar`, `writeBoolean`, `writeUTF`).

When creating a `RandomAccessFile`, you can specify one of two modes: `r` or `rw`. Mode `r` means that the stream is read-only, and mode `rw` indicates that the stream allows both read and write. For example, the following statement creates a new stream, `raf`, that allows the program to read from and write to the file `test.dat`:

```
RandomAccessFile raf = new RandomAccessFile("test.dat", "rw");
```

If `test.dat` already exists, `raf` is created to access it; if `test.dat` does not exist, a new file named `test.dat` is created, and `raf` is created to access the new file. The method `raf.length()` returns the number of bytes in `test.dat` at any given time. If you append new data into the file, `raf.length()` increases.



read-only
write-only
sequential
random-access file

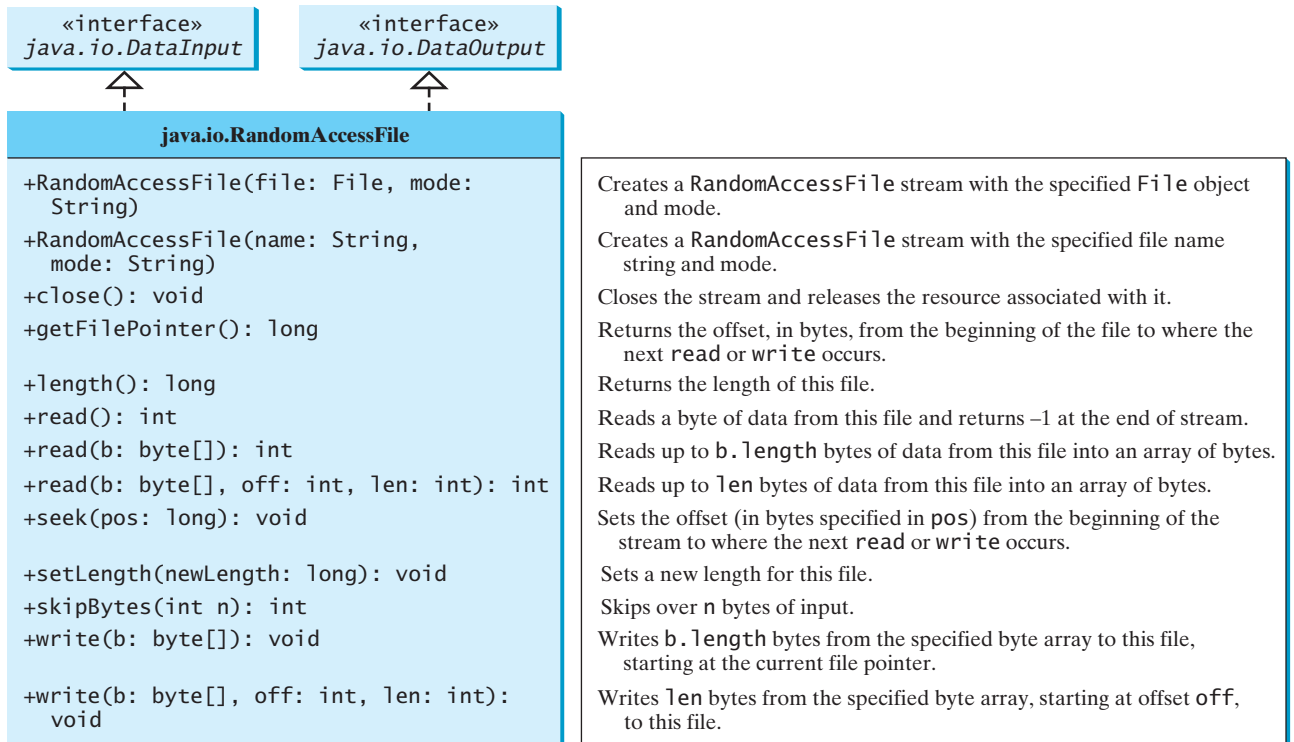


FIGURE 19.17 `RandomAccessFile` implements the `DataInput` and `DataOutput` interfaces with additional methods to support random access.



Tip

If the file is not intended to be modified, open it with the `r` mode. This prevents unintentional modification of the file.

file pointer

A random-access file consists of a sequence of bytes. A special marker called a *file pointer* is positioned at one of these bytes. A read or write operation takes place at the location of the file pointer. When a file is opened, the file pointer is set at the beginning of the file. When you read or write data to the file, the file pointer moves forward to the next data item. For example, if you read an `int` value using `readInt()`, the JVM reads 4 bytes from the file pointer, and now the file pointer is 4 bytes ahead of the previous location, as shown in Figure 19.18.

For a `RandomAccessFile` `raf`, you can use the `raf.seek(position)` method to move the file pointer to a specified position. `raf.seek(0)` moves it to the beginning of the file, and `raf.seek(raf.length())` moves it to the end of the file. Listing 19.8 demonstrates

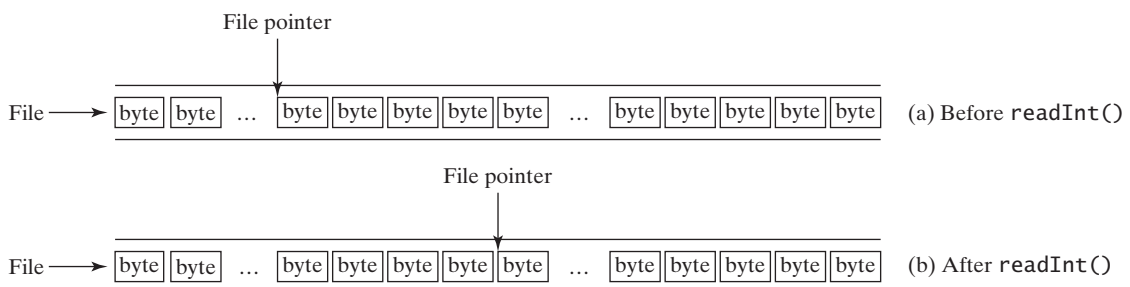


FIGURE 19.18 After an `int` value is read, the file pointer is moved 4 bytes ahead.

RandomAccessFile. A large case study of using **RandomAccessFile** to organize an address book is given in Supplement VI.B.

LISTING 19.8 TestRandomAccessFile.java

```

1  import java.io.*;
2
3  public class TestRandomAccessFile {
4      public static void main(String[] args) throws IOException {
5          // Create a random-access file
6          RandomAccessFile inout = new RandomAccessFile("inout.dat", "rw");
7
8          // Clear the file to destroy the old contents, if any
9          inout.setLength(0);
10
11         // Write new integers to the file
12         for (int i = 0; i < 200; i++)
13             inout.writeInt(i);
14
15         // Display the current length of the file
16         System.out.println("Current file length is " + inout.length());
17
18         // Retrieve the first number
19         inout.seek(0); // Move the file pointer to the beginning
20         System.out.println("The first number is " + inout.readInt());
21
22         // Retrieve the second number
23         inout.seek(1 * 4); // Move the file pointer to the second number
24         System.out.println("The second number is " + inout.readInt());
25
26         // Retrieve the tenth number
27         inout.seek(9 * 4); // Move the file pointer to the tenth number
28         System.out.println("The tenth number is " + inout.readInt());
29
30         // Modify the eleventh number
31         inout.writeInt(555);
32
33         // Append a new number
34         inout.seek(inout.length()); // Move the file pointer to the end
35         inout.writeInt(999);
36
37         // Display the new length
38         System.out.println("The new length is " + inout.length());
39
40         // Retrieve the new eleventh number
41         inout.seek(10 * 4); // Move the file pointer to the next number
42         System.out.println("The eleventh number is " + inout.readInt());
43
44         inout.close();
45     }
46 }

```

RandomAccessFile
empty file
write
move pointer
read
close file

```

Current file length is 800
The first number is 0
The second number is 1
The tenth number is 9
The new length is 804
The eleventh number is 555

```



A `RandomAccessFile` is created for the file named `inout.dat` with mode `rw` to allow both read and write operations in line 6.

`inout.setLength(0)` sets the length to `0` in line 9. This, in effect, destroys the old contents of the file.

The `for` loop writes `200 int` values from `0` to `199` into the file in lines 12–13. Since each `int` value takes `4` bytes, the total length of the file returned from `inout.length()` is now `800` (line 16), as shown in the sample output.

Invoking `inout.seek(0)` in line 19 sets the file pointer to the beginning of the file. `inout.readInt()` reads the first value in line 20 and moves the file pointer to the next number. The second number is read in line 24.

`inout.seek(9 * 4)` (line 27) moves the file pointer to the tenth number. `inout.readInt()` reads the tenth number and moves the file pointer to the eleventh number in line 28. `inout.write(555)` writes a new eleventh number at the current position (line 31). The previous eleventh number is destroyed.

`inout.seek(inout.length())` moves the file pointer to the end of the file (line 34). `inout.writeInt(999)` writes a `999` to the file. Now the length of the file is increased by `4`, so `inout.length()` returns `804` (line 38).

`inout.seek(10 * 4)` moves the file pointer to the eleventh number in line 41. The new eleventh number, `555`, is displayed in line 42.



MyProgrammingLab™

19.31 Can `RandomAccessFile` streams read and write a data file created by `DataOutputStream`? Can `RandomAccessFile` streams read and write objects?

19.32 Create a `RandomAccessFile` stream for the file `address.dat` to allow the updating of student information in the file. Create a `DataOutputStream` for the file `address.dat`. Explain the differences between these two statements.

19.33 What happens if the file `test.dat` does not exist when you attempt to compile and run the following code?

```
import java.io.*;

public class Test {
    public static void main(String[] args) {
        try {
            RandomAccessFile raf =
                new RandomAccessFile("test.dat", "r");
            int i = raf.readInt();
        }
        catch (IOException ex) {
            System.out.println("IO exception");
        }
    }
}
```

KEY TERMS

binary I/O 710
 deserialization 727
 file pointer 730
 random-access file 729

sequential-access file 729
 serialization 727
 stream 710
 text I/O 710

CHAPTER SUMMARY

1. I/O can be classified into *text I/O* and *binary I/O*. Text I/O interprets data in sequences of characters. Binary I/O interprets data as raw binary values. How text is stored in a file depends on the encoding scheme for the file. Java automatically performs encoding and decoding for text I/O.
2. The `InputStream` and `OutputStream` classes are the roots of all binary I/O classes. `FileInputStream/FileOutputStream` associates a file for input/output. `BufferedInputStream/BufferedOutputStream` can be used to wrap any binary I/O stream to improve performance. `DataInputStream/DataOutputStream` can be used to read/write primitive values and strings.
3. `ObjectInputStream/ObjectOutputStream` can be used to read/write objects in addition to primitive values and strings. To enable object *serialization*, the object's defining class must implement the `java.io.Serializable` marker interface.
4. The `RandomAccessFile` class enables you to read and write data to a file. You can open a file with the `r` mode to indicate that it is read-only, or with the `rw` mode to indicate that it is updateable. Since the `RandomAccessFile` class implements `DataInput` and `DataOutput` interfaces, many methods in `RandomAccessFile` are the same as those in `DataInputStream` and `DataOutputStream`.

TEST QUESTIONS

Do the test questions for this chapter online at www.cs.armstrong.edu/liang/intro9e/test.html.

PROGRAMMING EXERCISES

MyProgrammingLab™

Section 19.3

- *19.1 (Create a text file) Write a program to create a file named `Exercise19_01.txt` if it does not exist. Append new data to it if it already exists. Write 100 integers created randomly into the file using text I/O. Integers are separated by a space.

Section 19.4

- *19.2 (Create a binary data file) Write a program to create a file named `Exercise19_02.dat` if it does not exist. Append new data to it if it already exists. Write 100 integers created randomly into the file using binary I/O.
- *19.3 (Sum all the integers in a binary data file) Suppose a binary data file named `Exercise19_03.dat` has been created and its data are created using `writeInt(int)` in `DataOutputStream`. The file contains an unspecified number of integers. Write a program to find the sum of the integers.
- *19.4 (Convert a text file into UTF) Write a program that reads lines of characters from a text file and writes each line as a UTF-8 string into a binary file. Display the sizes of the text file and the binary file. Use the following command to run the program:

```
java Exercise19_04 Welcome.java Welcome.utf
```

Section 19.6

- *19.5 (Store objects and arrays in a file) Write a program that stores an array of the five `int` values **1**, **2**, **3**, **4** and **5**, a `Date` object for the current time, and the `double` value **5.5** into the file named **Exercise19_05.dat**.
- *19.6 (Store *Loan* objects) The `Loan` class in Listing 10.2 does not implement `Serializable`. Rewrite the `Loan` class to implement `Serializable`. Write a program that creates five `Loan` objects and stores them in a file named **Exercise19_06.dat**.
- *19.7 (Restore objects from a file) Suppose a file named **Exercise19_07.dat** has been created using the `ObjectOutputStream`. The file contains `Loan` objects. The `Loan` class in Listing 10.2 does not implement `Serializable`. Rewrite the `Loan` class to implement `Serializable`. Write a program that reads the `Loan` objects from the file and computes the total loan amount. Suppose you don't know how many `Loan` objects are in the file. Use `EOFException` to end the loop.

Section 19.7

- *19.8 (Update count) Suppose you want to track how many times a program has been executed. You can store an `int` to count the file. Increase the count by **1** each time this program is executed. Let the program be **Exercise19_08** and store the count in **Exercise19_08.dat**.
- ***19.9 (Address book) Supplement VI.B has a case study of using random-access files for creating and manipulating an address book. Modify the case study by adding an *Update* button, as shown in Figure 19.19, to enable the user to modify the address that is being displayed.



FIGURE 19.19 The application can store, retrieve, and update addresses from a file.

Comprehensive

- *19.10 (*Split files*) Suppose you want to back up a huge file (e.g., a 10-GB AVI file) to a CD-R. You can achieve it by splitting the file into smaller pieces and backing up these pieces separately. Write a utility program that splits a large file into smaller ones using the following command:

```
java Exercise19_10 SourceFile numberOfPieces
```

The command creates the files **SourceFile.1**, **SourceFile.2**, . . . , **SourceFile.n**, where **n** is `numberOfPieces` and the output files are about the same size.

- **19.11 (*Split files GUI*) Rewrite Exercise 19.10 with a GUI, as shown in Figure 19.20a.
- *19.12 (*Combine files*) Write a utility program that combines the files together into a new file using the following command:

```
java Exercise19_12 SourceFile1 . . . SourceFileN TargetFile
```

The command combines **SourceFile1**, . . . , and **SourceFileN** into **TargetFile**.

**VideoNote**

Split a large file

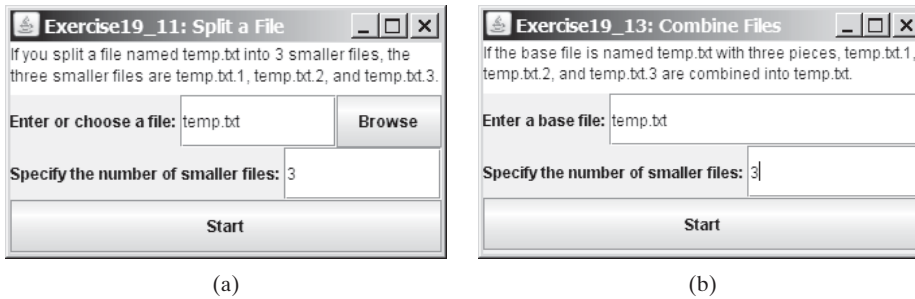


FIGURE 19.20 (a) The program splits a file. (b) The program combines files into a new file.

- *19.13 (*Combine files GUI*) Rewrite Exercise 19.12 with a GUI, as shown in Figure 19.20b.
- 19.14 (*Encrypt files*) Encode the file by adding 5 to every byte in the file. Write a program that prompts the user to enter an input file name and an output file name and saves the encrypted version of the input file to the output file.
- 19.15 (*Decrypt files*) Suppose a file is encrypted using the scheme in Programming Exercise 19.14. Write a program to decode an encrypted file. Your program should prompt the user to enter an input file name for the encrypted file and an output file name for the unencrypted version of the input file.
- 19.16 (*Frequency of characters*) Write a program that prompts the user to enter the name of an ASCII text file and displays the frequency of the characters in the file.
- **19.17 (*BitOutputStream*) Implement a class named `BitOutputStream`, as shown in Figure 19.21, for writing bits to an output stream. The `writeBit(char bit)` method stores the bit in a byte variable. When you create a `BitOutputStream`, the byte is empty. After invoking `writeBit('1')`, the byte becomes `00000001`. After invoking `writeBit("0101")`, the byte becomes `00010101`. The first three bits are not filled yet. When a byte is full, it is sent to the output stream. Now the byte is reset to empty. You must close the stream by invoking the `close()` method. If the byte is neither empty nor full, the `close()` method first fills the zeros to make a full 8 bits in the byte, and then outputs the byte and closes the stream. For a hint, see Programming Exercise 4.46. Write a test program that sends the bits `010000100100001001101` to the file named `Exercise19_17.dat`.

BitOutputStream	
<pre>+BitOutputStream(file: File) +writeBit(char bit): void +writeBit(String bit): void +close(): void</pre>	<pre>Creates a BitOutputStream to writes bits to the file. Writes a bit '0' or '1' to the output stream. Writes a string of bits to the output stream. This method must be invoked to close the stream.</pre>

FIGURE 19.21 `BitOutputStream` outputs a stream of bits to a file.

- *19.18 (*View bits*) Write the following method that displays the bit representation for the last byte in an integer:

```
public static String getBits(int value)
```

For a hint, see Programming Exercise 4.46. Write a program that prompts the user to enter a file name, reads bytes from the file, and displays each byte's binary representation.

- *19.19 (*View hex*) Write a program that prompts the user to enter a file name, reads bytes from the file, and displays each byte's hex representation. (*Hint*: You can first convert the byte value into an 8-bit string, then convert the bit string into a two-digit hex string.)
- **19.20 (*Binary editor*) Write a GUI application that lets the user enter a file name in the text field and press the *Enter* key to display its binary representation in a text area. The user can also modify the binary code and save it back to the file, as shown in Figure 19.22a.

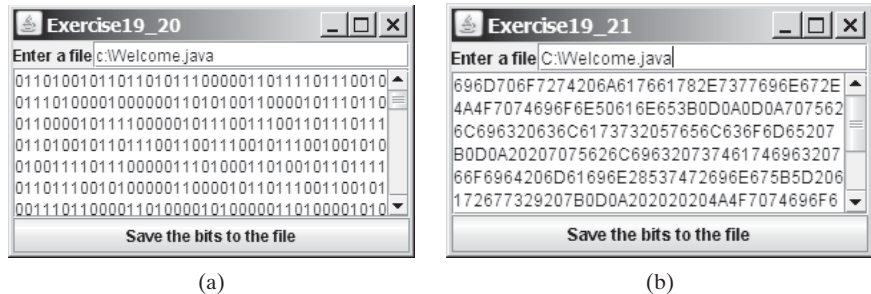


FIGURE 19.22 The programs enable the user to manipulate the contents of the file in (a) binary and (b) hex.

- **19.21 (*Hex editor*) Write a GUI application that lets the user enter a file name in the text field and press the *Enter* key to display its hex representation in a text area. The user can also modify the hex code and save it back to the file, as shown in Figure 19.22b.

RECURSION

Objectives

- To describe what a recursive method is and the benefits of using recursion (§20.1).
- To develop recursive methods for recursive mathematical functions (§§20.2–20.3).
- To explain how recursive method calls are handled in a call stack (§§20.2–20.3).
- To solve problems using recursion (§20.4).
- To use an overloaded helper method to design a recursive method (§20.5).
- To implement a selection sort using recursion (§20.5.1).
- To implement a binary search using recursion (§20.5.2).
- To get the directory size using recursion (§20.6).
- To solve the Towers of Hanoi problem using recursion (§20.7).
- To draw fractals using recursion (§20.8).
- To discover the relationship and difference between recursion and iteration (§20.9).
- To know tail-recursive methods and why they are desirable (§20.10).



20.1 Introduction



Recursion is a technique that leads to elegant solutions to problems that are difficult to program using simple loops.

search word problem

Suppose you want to find all the files under a directory that contain a particular word. How do you solve this problem? There are several ways to do so. An intuitive and effective solution is to use recursion by searching the files in the subdirectories recursively.

H-tree problem

H-trees, depicted in Figure 20.1, are used in a very large-scale integration (VLSI) design as a clock distribution network for routing timing signals to all parts of a chip with equal propagation delays. How do you write a program to display H-trees? A good approach is to use recursion.

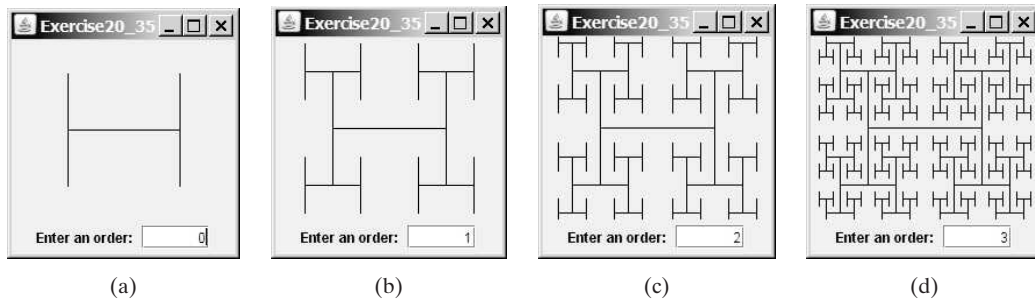


FIGURE 20.1 An H-tree can be displayed using recursion.

recursive method

To use recursion is to program using *recursive methods*—that is, to use methods that invoke themselves. Recursion is a useful programming technique. In some cases, it enables you to develop a natural, straightforward, simple solution to an otherwise difficult problem. This chapter introduces the concepts and techniques of recursive programming and illustrates with examples of how to “think recursively.”

20.2 Case Study: Computing Factorials



A recursive method is one that invokes itself.

Many mathematical functions are defined using recursion. Let’s begin with a simple example. The factorial of a number **n** can be recursively defined as follows:

$$\begin{aligned} 0! &= 1; \\ n! &= n \times (n - 1)!; \quad n > 0 \end{aligned}$$

How do you find **n!** for a given **n**? To find **1!** is easy, because you know that **0!** is **1**, and **1!** is **1 × 0!**. Assuming that you know **(n - 1)!**, you can obtain **n!** immediately by using **n × (n - 1)!**. Thus, the problem of computing **n!** is reduced to computing **(n - 1)!**. When computing **(n - 1)!**, you can apply the same idea recursively until **n** is reduced to **0**.

Let **factorial(n)** be the method for computing **n!**. If you call the method with **n = 0**, it immediately returns the result. The method knows how to solve the simplest case, which is referred to as the *base case* or the *stopping condition*. If you call the method with **n > 0**, it reduces the problem into a subproblem for computing the factorial of **n - 1**. The *subproblem* is essentially the same as the original problem, but it is simpler or smaller. Because the subproblem has the same property as the original problem, you can call the method with a different argument, which is referred to as a *recursive call*.

The recursive algorithm for computing **factorial(n)** can be simply described as follows:

```
if (n == 0)
    return 1;
```

base case or stopping condition

recursive call

```

else
    return n * factorial(n - 1);

```

A recursive call can result in many more recursive calls, because the method keeps on dividing a subproblem into new subproblems. For a recursive method to terminate, the problem must eventually be reduced to a stopping case, at which point the method returns a result to its caller. The caller then performs a computation and returns the result to its own caller. This process continues until the result is passed back to the original caller. The original problem can now be solved by multiplying `n` by the result of `factorial(n - 1)`.

Listing 20.1 gives a complete program that prompts the user to enter a nonnegative integer and displays the factorial for the number.

LISTING 20.1 ComputeFactorial.java

```

1  import java.util.Scanner;
2
3  public class ComputeFactorial {
4      /** Main method */
5      public static void main(String[] args) {
6          // Create a Scanner
7          Scanner input = new Scanner(System.in);
8          System.out.print("Enter a nonnegative integer: ");
9          int n = input.nextInt();
10
11         // Display factorial
12         System.out.println("Factorial of " + n + " is " + factorial(n));
13     }
14
15     /** Return the factorial for the specified number */
16     public static long factorial(int n) {
17         if (n == 0) // Base case
18             return 1;
19         else
20             return n * factorial(n - 1); // Recursive call
21     }
22 }

```

base case

recursion

```

Enter a nonnegative integer: 4 ↵
Factorial of 4 is 24

```



```

Enter a nonnegative integer: 10 ↵
Factorial of 10 is 3628800

```



The `factorial` method (lines 16–21) is essentially a direct translation of the recursive mathematical definition for the factorial into Java code. The call to `factorial` is recursive because it calls itself. The parameter passed to `factorial` is decremented until it reaches the base case of `0`.

You see how to write a recursive method. How does recursion work? Figure 20.2 illustrates the execution of the recursive calls, starting with `n = 4`. The use of stack space for recursive calls is shown in Figure 20.3.

how does it work?

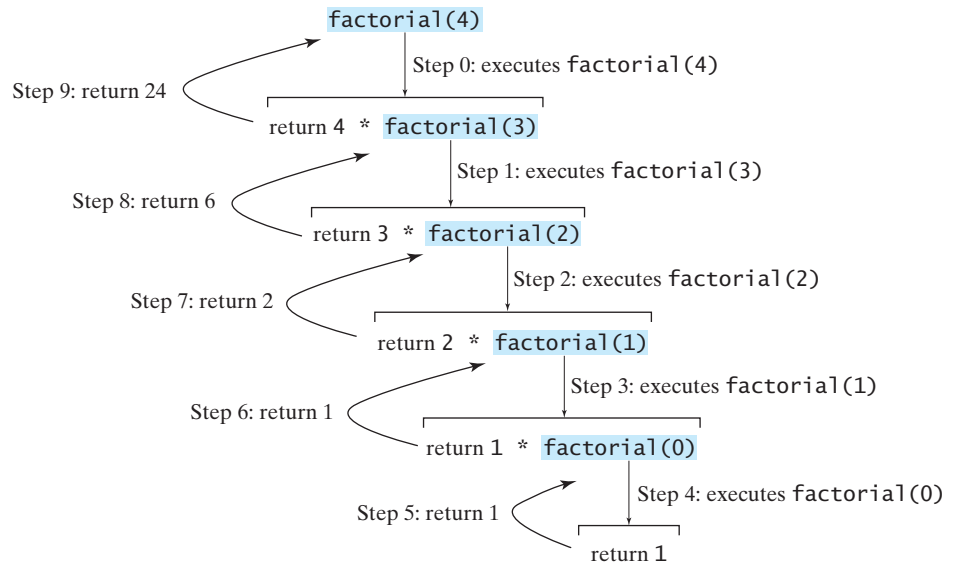


FIGURE 20.2 Invoking `factorial(4)` spawns recursive calls to `factorial`.

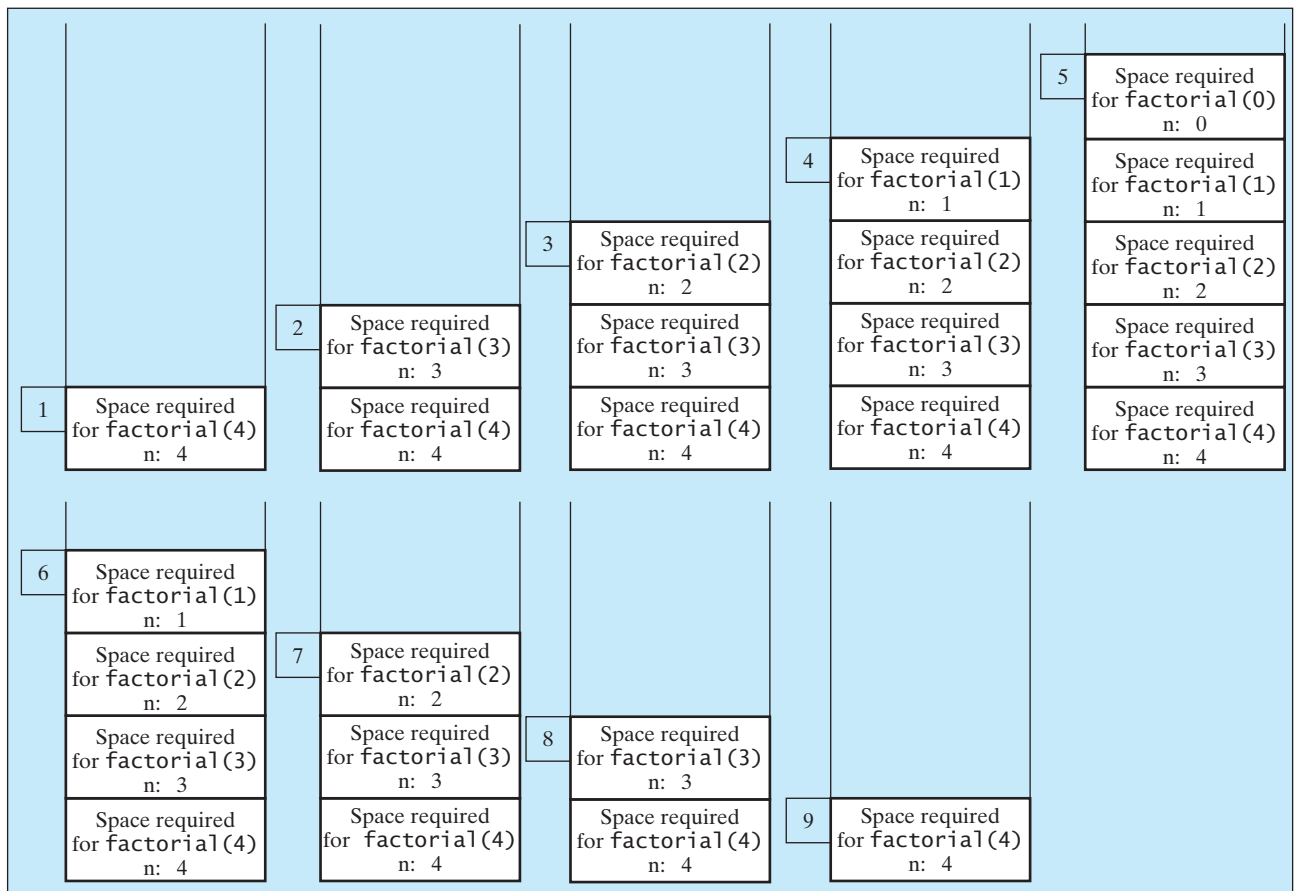


FIGURE 20.3 When `factorial(4)` is being executed, the `factorial` method is called recursively, causing stack space to dynamically change.

**Pedagogical Note**

It is simpler and more efficient to implement the **factorial** method using a loop. However, we use the recursive **factorial** method here to demonstrate the concept of recursion. Later in this chapter, we will present some problems that are inherently recursive and are difficult to solve without using recursion.

If recursion does not reduce the problem in a manner that allows it to eventually converge into the base case, *infinite recursion* can occur. For example, suppose you mistakenly write the **factorial** method as follows:

```
public static long factorial(int n) {
    return n * factorial(n - 1);
}
```

The method runs infinitely and causes a **StackOverflowError**.

The example discussed in this section shows a recursive method that invokes itself. This is known as *direct recursion*. It is also possible to create *indirect recursion*. This occurs when method **A** invokes method **B**, which in turn invokes method **A**. There can even be several more methods involved in the recursion. For example, method **A** invokes method **B**, which invokes method **C**, which invokes method **A**.

infinite recursion

direct recursion
indirect recursion

20.1 What is a recursive method? What is an infinite recursion?

20.2 How many times is the **factorial** method in Listing 20.1 invoked for **factorial(6)**?

20.3 Show the output of the following programs and identify base cases and recursive calls.



MyProgrammingLab™

```
public class Test {
    public static void main(String[] args) {
        System.out.println(
            "Sum is " + xMethod(5));
    }

    public static int xMethod(int n) {
        if (n == 1)
            return 1;
        else
            return n + xMethod(n - 1);
    }
}
```

```
public class Test {
    public static void main(String[] args) {
        xMethod(1234567);
    }

    public static void xMethod(int n) {
        if (n > 0) {
            System.out.print(n % 10);
            xMethod(n / 10);
        }
    }
}
```

20.4 Write a recursive mathematical definition for computing 2^n for a positive integer n .

20.5 Write a recursive mathematical definition for computing x^n for a positive integer n and a real number x .

20.6 Write a recursive mathematical definition for computing $1 + 2 + 3 + \dots + n$ for a positive integer.

20.3 Case Study: Computing Fibonacci Numbers

In some cases, recursion enables you to create an intuitive, straightforward, simple solution to a problem.



The **factorial** method in the preceding section could easily be rewritten without using recursion. In this section, we show an example for creating an intuitive solution to a problem using recursion. Consider the well-known Fibonacci-series problem:

The series: 0 1 1 2 3 5 8 13 21 34 55 89 ...
 indices: 0 1 2 3 4 5 6 7 8 9 10 11

The Fibonacci series begins with **0** and **1**, and each subsequent number is the sum of the preceding two. The series can be recursively defined as:

```
fib(0) = 0;
fib(1) = 1;
fib(index) = fib(index - 2) + fib(index - 1); index >= 2
```

The Fibonacci series was named for Leonardo Fibonacci, a medieval mathematician, who originated it to model the growth of the rabbit population. It can be applied in numeric optimization and in various other areas.

How do you find **fib(index)** for a given **index**? It is easy to find **fib(2)**, because you know **fib(0)** and **fib(1)**. Assuming that you know **fib(index - 2)** and **fib(index - 1)**, you can obtain **fib(index)** immediately. Thus, the problem of computing **fib(index)** is reduced to computing **fib(index - 2)** and **fib(index - 1)**. When doing so, you apply the idea recursively until **index** is reduced to **0** or **1**.

The base case is **index = 0** or **index = 1**. If you call the method with **index = 0** or **index = 1**, it immediately returns the result. If you call the method with **index >= 2**, it divides the problem into two subproblems for computing **fib(index - 1)** and **fib(index - 2)** using recursive calls. The recursive algorithm for computing **fib(index)** can be simply described as follows:

```
if (index == 0)
    return 0;
else if (index == 1)
    return 1;
else
    return fib(index - 1) + fib(index - 2);
```

Listing 20.2 gives a complete program that prompts the user to enter an index and computes the Fibonacci number for that index.

LISTING 20.2 ComputeFibonacci.java

```
1  import java.util.Scanner;
2
3  public class ComputeFibonacci {
4      /** Main method */
5      public static void main(String[] args) {
6          // Create a Scanner
7          Scanner input = new Scanner(System.in);
8          System.out.print("Enter an index for a Fibonacci number: ");
9          int index = input.nextInt();
10
11         // Find and display the Fibonacci number
12         System.out.println("The Fibonacci number at index "
13             + index + " is " + fib(index));
14     }
15
16     /** The method for finding the Fibonacci number */
17     public static long fib(long index) {
18         if (index == 0) // Base case
19             return 0;
```

base case

```

20     else if (index == 1) // Base case
21         return 1;
22     else // Reduction and recursive calls
23         return fib(index - 1) + fib(index - 2);
24 }
25 }

```

base case
recursion

Enter an index for a Fibonacci number: 1
The Fibonacci number at index 1 is 1



Enter an index for a Fibonacci number: 6
The Fibonacci number at index 6 is 8



Enter an index for a Fibonacci number: 7
The Fibonacci number at index 7 is 13



The program does not show the considerable amount of work done behind the scenes by the computer. Figure 20.4, however, shows the successive recursive calls for evaluating `fib(4)`. The original method, `fib(4)`, makes two recursive calls, `fib(3)` and `fib(2)`, and then returns `fib(3) + fib(2)`. But in what order are these methods called? In Java, operands are evaluated from left to right, so `fib(2)` is called after `fib(3)` is completely evaluated. The labels in Figure 20.4 show the order in which the methods are called.

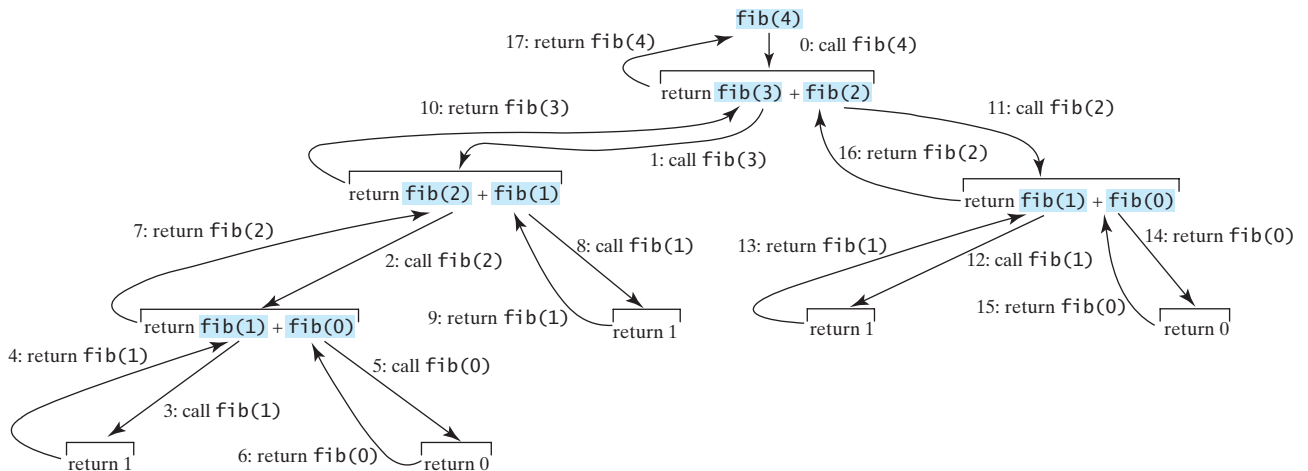


FIGURE 20.4 Invoking `fib(4)` spawns recursive calls to `fib`.

As shown in Figure 20.4, there are many duplicated recursive calls. For instance, `fib(2)` is called twice, `fib(1)` three times, and `fib(0)` twice. In general, computing `fib(index)` requires roughly twice as many recursive calls as does computing `fib(index - 1)`. As you try larger index values, the number of calls substantially increases, as shown in Table 20.1.

TABLE 20.1 Number of Recursive Calls in `fib(index)`

index	2	3	4	10	20	30	40	50
# of calls	3	5	9	177	21891	2,692,537	331,160,281	2,075,316,483

**Pedagogical Note**

The recursive implementation of the **fib** method is very simple and straightforward, but it isn't efficient, since it requires more time and memory to run recursive methods. See Programming Exercise 20.2 for an efficient solution using loops. Though it is not practical, the recursive **fib** method is a good example of how to write recursive methods.



20.7 Show the output of the following two programs:

MyProgrammingLab™

```
public class Test {
    public static void main(String[] args) {
        xMethod(5);
    }

    public static void xMethod(int n) {
        if (n > 0) {
            System.out.print(n + " ");
            xMethod(n - 1);
        }
    }
}
```

```
public class Test {
    public static void main(String[] args) {
        xMethod(5);
    }

    public static void xMethod(int n) {
        if (n > 0) {
            xMethod(n - 1);
            System.out.print(n + " ");
        }
    }
}
```

20.8 What is wrong in the following method?

```
public class Test {
    public static void main(String[] args) {
        xMethod(1234567);
    }

    public static void xMethod(double n) {
        if (n != 0) {
            System.out.print(n);
            xMethod(n / 10);
        }
    }
}
```

```
public class Test {
    public static void main(String[] args) {
        Test test = new Test();
        System.out.println(test.toString());
    }

    public Test() {
        Test test = new Test();
    }
}
```

20.9 How many times is the **fib** method in Listing 20.2 invoked for **fib(6)**?

20.4 Problem Solving Using Recursion



If you think recursively, you can solve many problems using recursion.

The preceding sections presented two classic recursion examples. All recursive methods have the following characteristics:

recursion characteristics

if-else

base cases

reduction

- The method is implemented using an **if-else** or a **switch** statement that leads to different cases.
- One or more base cases (the simplest case) are used to stop recursion.
- Every recursive call reduces the original problem, bringing it increasingly closer to a base case until it becomes that case.

In general, to solve a problem using recursion, you break it into subproblems. Each subproblem is the same as the original problem but smaller in size. You can apply the same approach to each subproblem to solve it recursively.

Recursion is everywhere. It is fun to *think recursively*. Consider drinking coffee. You may think recursively describe the procedure recursively as follows:

```
public static void drinkCoffee(Cup cup) {
    if (!cup.isEmpty()) {
        cup.takeOneSip(); // Take one sip
        drinkCoffee(cup);
    }
}
```

Assume `cup` is an object for a cup of coffee with the instance methods `isEmpty()` and `takeOneSip()`. You can break the problem into two subproblems: one is to drink one sip of coffee and the other is to drink the rest of the coffee in the cup. The second problem is the same as the original problem but smaller in size. The base case for the problem is when the cup is empty.

Consider the problem of printing a message `n` times. You can break the problem into two subproblems: one is to print the message one time and the other is to print it `n - 1` times. The second problem is the same as the original problem but it is smaller in size. The base case for the problem is `n == 0`. You can solve this problem using recursion as follows:

```
public static void nPrintln(String message, int times) {
    if (times >= 1) {
        System.out.println(message);
        nPrintln(message, times - 1); // recursive call
    } // The base case is times == 0
}
```

Note that the `fib` method in the preceding section returns a value to its caller, but the `drinkCoffee` and `nPrintln` methods are `void` and they do not return a value.

If you *think recursively*, you can use recursion to solve many of the problems presented in earlier chapters of this book. Consider the palindrome problem in Listing 9.1. Recall that a string is a palindrome if it reads the same from the left and from the right. For example, “mom” and “dad” are palindromes, but “uncle” and “aunt” are not. The problem of checking whether a string is a palindrome can be divided into two subproblems: think recursively

- Check whether the first character and the last character of the string are equal.
- Ignore the two end characters and check whether the rest of the substring is a palindrome.

The second subproblem is the same as the original problem but smaller in size. There are two base cases: (1) the two end characters are not the same, and (2) the string size is `0` or `1`. In case 1, the string is not a palindrome; in case 2, the string is a palindrome. The recursive method for this problem can be implemented as shown in Listing 20.3.

LISTING 20.3 RecursivePalindromeUsingSubstring.java

```
1 public class RecursivePalindromeUsingSubstring {
2     public static boolean isPalindrome(String s) { // method header
3         if (s.length() <= 1) // Base case // base case
4             return true;
5         else if (s.charAt(0) != s.charAt(s.length() - 1)) // Base case // base case
6             return false;
7         else
8             return isPalindrome(s.substring(1, s.length() - 1)); // recursive call
9     }
10
11 public static void main(String[] args) {
```

```

12     System.out.println("Is moon a palindrome? "
13         + isPalindrome("moon"));
14     System.out.println("Is noon a palindrome? "
15         + isPalindrome("noon"));
16     System.out.println("Is a a palindrome? " + isPalindrome("a"));
17     System.out.println("Is aba a palindrome? " +
18         isPalindrome("aba"));
19     System.out.println("Is ab a palindrome? " + isPalindrome("ab"));
20 }
21 }

```



```

Is moon a palindrome? false
Is noon a palindrome? true
Is a a palindrome? true
Is aba a palindrome? true
Is ab a palindrome? false

```

The **substring** method in line 8 creates a new string that is the same as the original string except without the first and last characters. Checking whether a string is a palindrome is equivalent to checking whether the substring is a palindrome if the two end characters in the original string are the same.



MyProgrammingLab™

20.10 Describe the characteristics of recursive methods.

20.11 For the **isPalindrome** method in Listing 20.3, what are the base cases? How many times is this method called when invoking **isPalindrome("abdxcdba")**?

20.12 Show the call stack for **isPalindrome("abcba")** using the method defined in Listing 20.3.

20.5 Recursive Helper Methods



Sometimes you can find a recursive solution by slightly changing the original problem. This new method is called a recursive helper method.

The recursive **isPalindrome** method in Listing 20.3 is not efficient, because it creates a new string for every recursive call. To avoid creating new strings, you can use the low and high indices to indicate the range of the substring. These two indices must be passed to the recursive method. Since the original method is **isPalindrome(String s)**, you have to create the new method **isPalindrome(String s, int low, int high)** to accept additional information on the string, as shown in Listing 20.4.

LISTING 20.4 RecursivePalindrome.java

```

1  public class RecursivePalindrome {
2      public static boolean isPalindrome(String s) {
3          return isPalindrome(s, 0, s.length() - 1);
4      }
5
6      private static boolean isPalindrome(String s, int low, int high) {
7          if (high <= low) // Base case
8              return true;
9          else if (s.charAt(low) != s.charAt(high)) // Base case
10             return false;
11         else
12             return isPalindrome(s, low + 1, high - 1);
13     }
14 }

```

helper method

base case

base case

```

15 public static void main(String[] args) {
16     System.out.println("Is moon a palindrome? "
17         + isPalindrome("moon"));
18     System.out.println("Is noon a palindrome? "
19         + isPalindrome("noon"));
20     System.out.println("Is a a palindrome? " + isPalindrome("a"));
21     System.out.println("Is aba a palindrome? " + isPalindrome("aba"));
22     System.out.println("Is ab a palindrome? " + isPalindrome("ab"));
23 }
24 }

```

Two overloaded `isPalindrome` methods are defined. The first, `isPalindrome(String s)`, checks whether a string is a palindrome, and the second, `isPalindrome(String s, int low, int high)`, checks whether a substring `s(low..high)` is a palindrome. The first method passes the string `s` with `low = 0` and `high = s.length() - 1` to the second method. The second method can be invoked recursively to check a palindrome in an ever-shrinking substring. It is a common design technique in recursive programming to define a second method that receives additional parameters. Such a method is known as a *recursive helper method*.

recursive helper method

Helper methods are very useful in designing recursive solutions for problems involving strings and arrays. The sections that follow give two more examples.

20.5.1 Recursive Selection Sort

Selection sort was introduced in Section 6.11.1. Recall that it finds the smallest element in the list and swaps it with the first element. It then finds the smallest element remaining and swaps it with the first element in the remaining list, and so on until the remaining list contains only a single element. The problem can be divided into two subproblems:

- Find the smallest element in the list and swap it with the first element.
- Ignore the first element and sort the remaining smaller list recursively.

The base case is that the list contains only one element. Listing 20.5 gives the recursive sort method.

LISTING 20.5 RecursiveSelectionSort.java

```

1 public class RecursiveSelectionSort {
2     public static void sort(double[] list) {
3         sort(list, 0, list.length - 1); // Sort the entire list
4     }
5
6     private static void sort(double[] list, int low, int high) {
7         if (low < high) {
8             // Find the smallest number and its index in list[low .. high]
9             int indexOfMin = low;
10            double min = list[low];
11            for (int i = low + 1; i <= high; i++) {
12                if (list[i] < min) {
13                    min = list[i];
14                    indexOfMin = i;
15                }
16            }
17
18            // Swap the smallest in list[low .. high] with list[low]
19            list[indexOfMin] = list[low];
20            list[low] = min;
21

```

helper method
base case

```

recursive call    22         // Sort the remaining list[low+1 .. high]
                  23         sort(list, low + 1, high);
                  24     }
                  25     }
                  26 }

```

Two overloaded `sort` methods are defined. The first method, `sort(double[] list)`, sorts an array in `list[0..list.length - 1]` and the second method, `sort(double[] list, int low, int high)`, sorts an array in `list[low..high]`. The second method can be invoked recursively to sort an ever-shrinking subarray.



VideoNote
Binary search

20.5.2 Recursive Binary Search

Binary search was introduced in Section 6.10.2. For binary search to work, the elements in the array must be in an increasing order. The binary search first compares the key with the element in the middle of the array. Consider the following three cases:

- Case 1: If the key is less than the middle element, recursively search for the key in the first half of the array.
- Case 2: If the key is equal to the middle element, the search ends with a match.
- Case 3: If the key is greater than the middle element, recursively search for the key in the second half of the array.

Case 1 and Case 3 reduce the search to a smaller list. Case 2 is a base case when there is a match. Another base case is that the search is exhausted without a match. Listing 20.6 gives a clear, simple solution for the binary search problem using recursion.

LISTING 20.6 Recursive Binary Search Method

```

1  public class RecursiveBinarySearch {
2      public static int recursiveBinarySearch(int[] list, int key) {
3          int low = 0;
4          int high = list.length - 1;
5          return recursiveBinarySearch(list, key, low, high);
6      }
7
8      private static int recursiveBinarySearch(int[] list, int key,
9          int low, int high) {
10         if (low > high) // The list has been exhausted without a match
11             return -low - 1;
12
13         int mid = (low + high) / 2;
14         if (key < list[mid])
15             return recursiveBinarySearch(list, key, low, mid - 1);
16         else if (key == list[mid])
17             return mid;
18         else
19             return recursiveBinarySearch(list, key, mid + 1, high);
20     }
21 }

```

helper method

base case

recursive call

base case

recursive call

The first method finds a key in the whole list. The second method finds a key in the list with index from `low` to `high`.

The first `binarySearch` method passes the initial array with `low = 0` and `high = list.length - 1` to the second `binarySearch` method. The second method is invoked recursively to find the key in an ever-shrinking subarray.

20.13 Show the call stack for `isPalindrome("abcba")` using the method defined in Listing 20.4.



20.14 Show the call stack for `selectionSort(new double[]{2, 3, 5, 1})` using the method defined in Listing 20.5.

MyProgrammingLab™

20.15 What is a recursive helper method?

20.6 Case Study: Finding the Directory Size

Recursive methods are efficient for solving problems with recursive structures.



The preceding examples can easily be solved without using recursion. This section presents a problem that is difficult to solve without using recursion. The problem is to find the size of a directory. The size of a directory is the sum of the sizes of all files in the directory. A directory d may contain subdirectories. Suppose a directory contains files f_1, f_2, \dots, f_m and subdirectories d_1, d_2, \dots, d_n , as shown in Figure 20.5.



Directory size

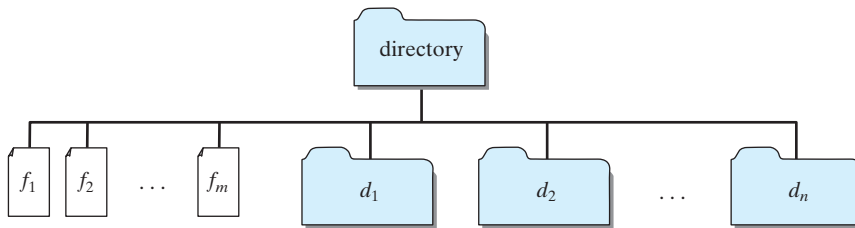


FIGURE 20.5 A directory contains files and subdirectories.

The size of the directory can be defined recursively as follows:

$$\text{size}(d) = \text{size}(f_1) + \text{size}(f_2) + \dots + \text{size}(f_m) + \text{size}(d_1) + \text{size}(d_2) + \dots + \text{size}(d_n)$$

The **File** class, introduced in Section 14.10, can be used to represent a file or a directory and obtain the properties for files and directories. Two methods in the **File** class are useful for this problem:

- The **length()** method returns the size of a file.
- The **listFiles()** method returns an array of **File** objects under a directory.

Listing 20.7 gives a program that prompts the user to enter a directory or a file and displays its size.

LISTING 20.7 DirectorySize.java

```

1  import java.io.File;
2  import java.util.Scanner;
3
4  public class DirectorySize {
5      public static void main(String[] args) {
6          // Prompt the user to enter a directory or a file
7          System.out.print("Enter a directory or a file: ");
8          Scanner input = new Scanner(System.in);
9          String directory = input.nextLine();
10
11         // Display the size
12         System.out.println(getSize(new File(directory)) + " bytes");
13     }
14

```

invoke method

getSize method	15	public static long getSize(File file) {
	16	long size = 0; // Store the total size of all files
	17	
is directory?	18	if (file.isDirectory()) {
all subitems	19	File[] files = file.listFiles(); // All files and subdirectories
	20	for (int i = 0; files != null && i < files.length; i++) {
recursive call	21	size += getSize(files[i]); // Recursive call
	22	}
	23	}
base case	24	else { // Base case
	25	size += file.length();
	26	}
	27	
	28	return size;
	29	}
	30	}



Enter a directory or a file: c:\book ↵ Enter
48619631 bytes



Enter a directory or a file: c:\book\Welcome.java ↵ Enter
172 bytes



Enter a directory or a file: c:\book\NonExistentFile ↵ Enter
0 bytes

If the **file** object represents a directory (line 18), each subitem (file or subdirectory) in the directory is recursively invoked to obtain its size (line 21). If the **file** object represents a file (line 24), the file size is obtained (line 25).

What happens if an incorrect or a nonexistent directory is entered? The program will detect that it is not a directory and invoke **file.length()** (line 25), which returns **0**. Thus, in this case, the **getSize** method will return **0**.

**Tip**

To avoid mistakes, it is a good practice to test all cases. For example, you should test the program for an input of file, an empty directory, a nonexistent directory, and a nonexistent file.

testing all cases

**20.16** What is the base case for the **getSize** method?**20.17** How does the program get all files and directories under a given directory?

MyProgrammingLab™

20.18 How many times will the **getSize** method be invoked for a directory if the directory has three subdirectories and each subdirectory has four files?

20.7 Case Study: Towers of Hanoi



The Towers of Hanoi problem is a classic problem that can be solved easily using recursion, but it is difficult to solve otherwise.

The problem involves moving a specified number of disks of distinct sizes from one tower to another while observing the following rules:

- There are n disks labeled 1, 2, 3, . . . , n and three towers labeled A, B, and C.
- No disk can be on top of a smaller disk at any time.

- All the disks are initially placed on tower A.
- Only one disk can be moved at a time, and it must be the smallest disk on a tower.

The objective of the problem is to move all the disks from A to B with the assistance of C. For example, if you have three disks, the steps to move all of the disks from A to B are shown in Figure 20.6.

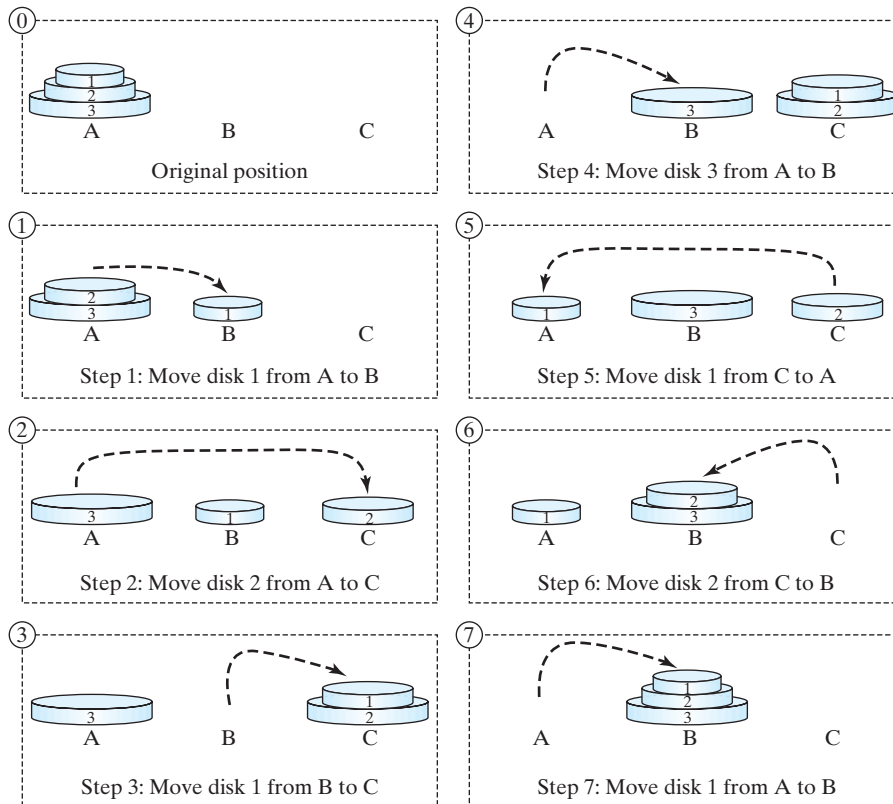


FIGURE 20.6 The goal of the Towers of Hanoi problem is to move disks from tower A to tower B without breaking the rules.



Note

The Towers of Hanoi is a classic computer-science problem, to which many websites are devoted. One of them worth looking at is www.cut-the-knot.com/recurrence/hanoi.html.

In the case of three disks, you can find the solution manually. For a larger number of disks, however—even for four—the problem is quite complex. Fortunately, the problem has an inherently recursive nature, which leads to a straightforward recursive solution.

The base case for the problem is $n = 1$. If $n == 1$, you could simply move the disk from A to B. When $n > 1$, you could split the original problem into the following three subproblems and solve them sequentially.

1. Move the first $n - 1$ disks from A to C with the assistance of tower B, as shown in Step 1 in Figure 20.7.
2. Move disk n from A to B, as shown in Step 2 in Figure 20.7.
3. Move $n - 1$ disks from C to B with the assistance of tower A, as shown in Step 3 in Figure 20.7.

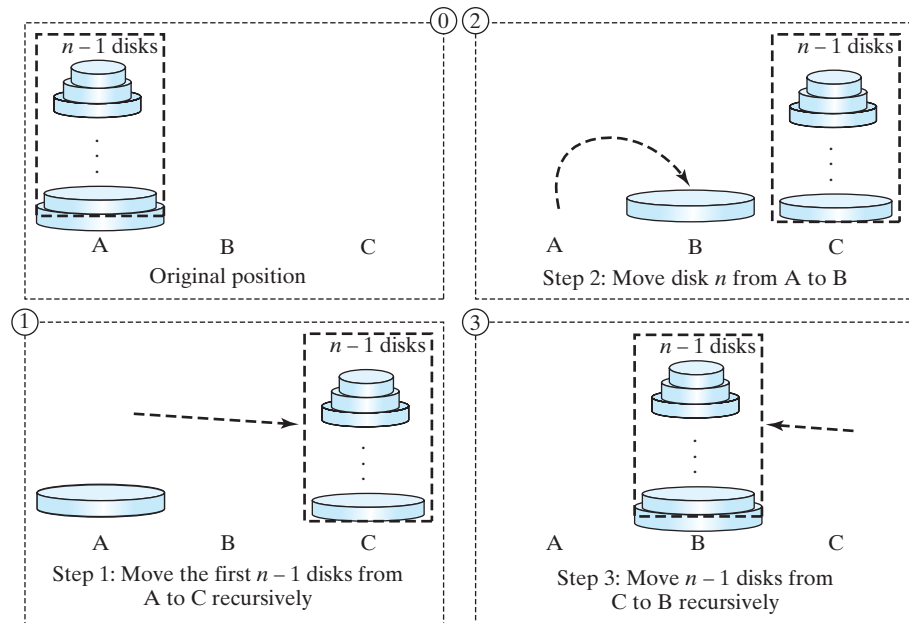


FIGURE 20.7 The Towers of Hanoi problem can be decomposed into three subproblems.

The following method moves n disks from the **fromTower** to the **toTower** with the assistance of the **auxTower**:

```
void moveDisks(int n, char fromTower, char toTower, char auxTower)
```

The algorithm for the method can be described as:

```
if (n == 1) // Stopping condition
    Move disk 1 from the fromTower to the toTower;
else {
    moveDisks(n - 1, fromTower, auxTower, toTower);
    Move disk n from the fromTower to the toTower;
    moveDisks(n - 1, auxTower, toTower, fromTower);
}
```

Listing 20.8 gives a program that prompts the user to enter the number of disks and invokes the recursive method **moveDisks** to display the solution for moving the disks.

LISTING 20.8 TowersOfHanoi.java

```
1 import java.util.Scanner;
2
3 public class TowersOfHanoi {
4     /** Main method */
5     public static void main(String[] args) {
6         // Create a Scanner
7         Scanner input = new Scanner(System.in);
8         System.out.print("Enter number of disks: ");
9         int n = input.nextInt();
10
11         // Find the solution recursively
12         System.out.println("The moves are:");
13         moveDisks(n, 'A', 'B', 'C');
14     }
15 }
```

```

16  /** The method for finding the solution to move n disks
17      from fromTower to toTower with auxTower */
18  public static void moveDisks(int n, char fromTower,
19      char toTower, char auxTower) {
20      if (n == 1) // Stopping condition                base case
21          System.out.println("Move disk " + n + " from " +
22              fromTower + " to " + toTower);
23      else {
24          moveDisks(n - 1, fromTower, auxTower, toTower);    recursion
25          System.out.println("Move disk " + n + " from " +
26              fromTower + " to " + toTower);
27          moveDisks(n - 1, auxTower, toTower, fromTower);    recursion
28      }
29  }
30  }

```



```

Enter number of disks: 4  → Enter
The moves are:
Move disk 1 from A to C
Move disk 2 from A to B
Move disk 1 from C to B
Move disk 3 from A to C
Move disk 1 from B to A
Move disk 2 from B to C
Move disk 1 from A to C
Move disk 4 from A to B
Move disk 1 from C to B
Move disk 2 from C to A
Move disk 1 from B to A
Move disk 3 from C to B
Move disk 1 from A to C
Move disk 2 from A to B
Move disk 1 from C to B

```

This problem is inherently recursive. Using recursion makes it possible to find a natural, simple solution. It would be difficult to solve the problem without using recursion.

Consider tracing the program for $n = 3$. The successive recursive calls are shown in Figure 20.8. As you can see, writing the program is easier than tracing the recursive calls. The

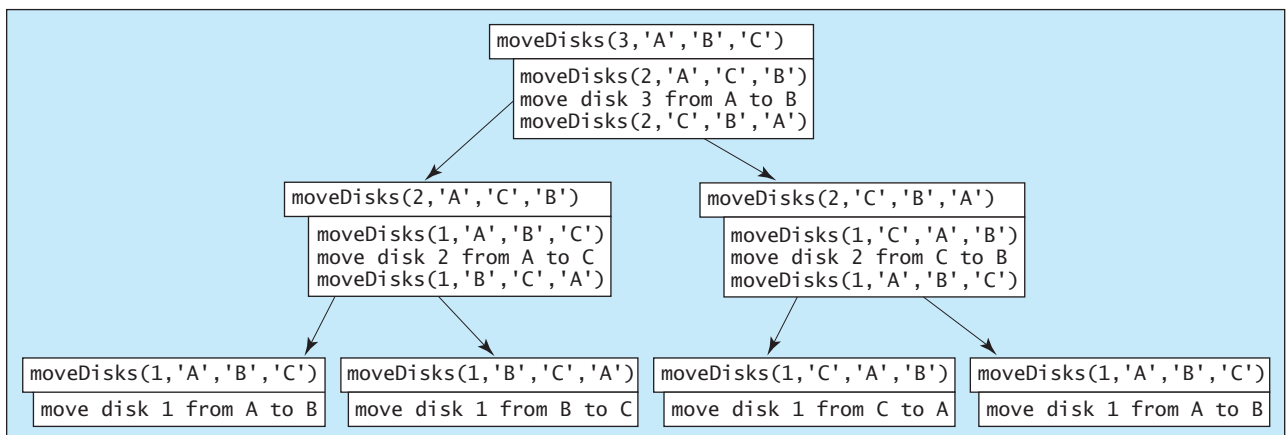


FIGURE 20.8 Invoking `moveDisks(3, 'A', 'B', 'C')` spawns calls to `moveDisks` recursively.

system uses stacks to manage the calls behind the scenes. To some extent, recursion provides a level of abstraction that hides iterations and other details from the user.



20.19 How many times is the `moveDisks` method in Listing 20.8 invoked for `moveDisks(5, 'A', 'B', 'C')`?

MyProgrammingLab™



20.8 Case Study: Fractals

Using recursion is ideal for displaying fractals, because fractals are inherently recursive.

A *fractal* is a geometrical figure, but unlike triangles, circles, and rectangles, fractals can be divided into parts, each of which is a reduced-size copy of the whole. There are many interesting examples of fractals. This section introduces a simple fractal, the *Sierpinski triangle*, named after a famous Polish mathematician.

A Sierpinski triangle is created as follows:

1. Begin with an equilateral triangle, which is considered to be a Sierpinski fractal of order **0**, as shown in Figure 20.9a.
2. Connect the midpoints of the sides of the triangle of order **0** to create a Sierpinski triangle of order **1** (Figure 20.9b).
3. Leave the center triangle intact. Connect the midpoints of the sides of the three other triangles to create a Sierpinski triangle of order **2** (Figure 20.9c).
4. You can repeat the same process recursively to create a Sierpinski triangle of order **3**, **4**, . . . , and so on (Figure 20.9d).

The problem is inherently recursive. How do you develop a recursive solution for it? Consider the base case when the order is **0**. It is easy to draw a Sierpinski triangle of order **0**.

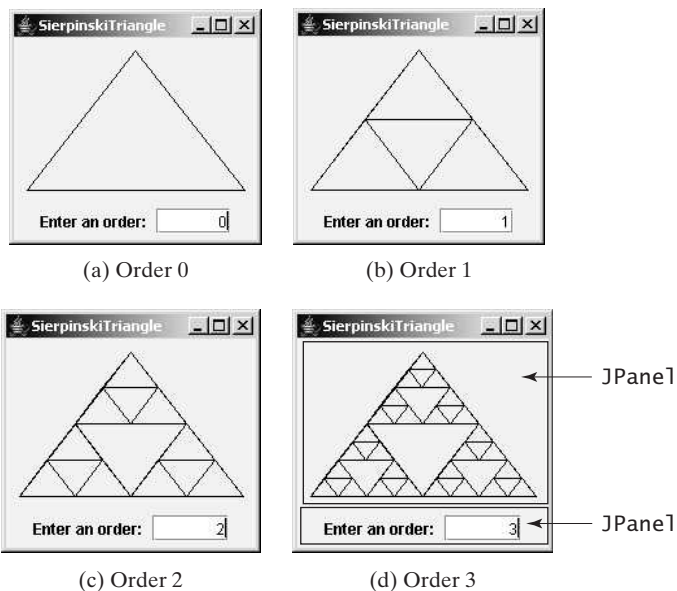


FIGURE 20.9 A Sierpinski triangle is a pattern of recursive triangles.

How do you draw a Sierpinski triangle of order **1**? The problem can be reduced to drawing three Sierpinski triangles of order **0**. How do you draw a Sierpinski triangle of order **2**? The problem can be reduced to drawing three Sierpinski triangles of order **1**, so the problem of drawing a Sierpinski triangle of order ***n*** can be reduced to drawing three Sierpinski triangles of order ***n* - 1**.

Listing 20.9 gives a Java applet that displays a Sierpinski triangle of any order, as shown in Figure 20.9. You can enter an order in a text field to display a Sierpinski triangle of the specified order.

LISTING 20.9 SierpinskiTriangle.java

```

1  import javax.swing.*;
2  import java.awt.*;
3  import java.awt.event.*;
4
5  public class SierpinskiTriangle extends JApplet {
6      private JTextField jtfOrder = new JTextField("0", 5); // Order
7      private SierpinskiTrianglePanel trianglePanel =
8          new SierpinskiTrianglePanel(); // To display the pattern
9
10     public SierpinskiTriangle() {
11         // Panel to hold label, text field, and a button
12         JPanel panel = new JPanel();
13         panel.add(new JLabel("Enter an order: "));
14         panel.add(jtfOrder);
15         jtfOrder.setHorizontalAlignment(SwingConstants.RIGHT);
16
17         // Add a Sierpinski triangle panel to the applet
18         add(trianglePanel);
19         add(panel, BorderLayout.SOUTH);
20
21         // Register a listener
22         jtfOrder.addActionListener(new ActionListener() {           listener
23             @Override
24             public void actionPerformed(ActionEvent e) {
25                 trianglePanel.setOrder(Integer.parseInt(jtfOrder.getText())); set a new order
26             }
27         });
28     }
29
30     static class SierpinskiTrianglePanel extends JPanel {
31         private int order = 0;
32
33         /** Set a new order */
34         public void setOrder(int order) {
35             this.order = order;
36             repaint();
37         }
38
39         @Override
40         protected void paintComponent(Graphics g) {
41             super.paintComponent(g);
42
43             // Select three points in proportion to the panel size
44             Point p1 = new Point(getWidth() / 2, 10);           three initial points
45             Point p2 = new Point(10, getHeight() - 10);
46             Point p3 = new Point(getWidth() - 10, getHeight() - 10);
47

```

```

48     displayTriangles(g, order, p1, p2, p3);
49     }
50
51     private static void displayTriangles(Graphics g, int order,
52         Point p1, Point p2, Point p3) {
53         if (order == 0) {
54             // Draw a triangle to connect three points
55             g.drawLine(p1.x, p1.y, p2.x, p2.y);
56             g.drawLine(p1.x, p1.y, p3.x, p3.y);
57             g.drawLine(p2.x, p2.y, p3.x, p3.y);
58         }
59         else {
60             // Get the midpoint on each edge of the triangle
61             Point p12 = midpoint(p1, p2);
62             Point p23 = midpoint(p2, p3);
63             Point p31 = midpoint(p3, p1);
64
65             // Recursively display three triangles
66             displayTriangles(g, order - 1, p1, p12, p31);
67             displayTriangles(g, order - 1, p12, p2, p23);
68             displayTriangles(g, order - 1, p31, p23, p3);
69         }
70     }
71
72     private static Point midpoint(Point p1, Point p2) {
73         return new Point((p1.x + p2.x) / 2, (p1.y + p2.y) / 2);
74     }
75 }
76 }

```

draw a triangle

top subtriangle
left subtriangle
right subtriangle

main method omitted

displayTriangle method

The initial triangle has three points set in proportion to the panel size (lines 44–46). If `order == 0`, the `displayTriangles(g, order, p1, p2, p3)` method displays a triangle that connects the three points `p1`, `p2`, and `p3` in lines 55–57, as shown in Figure 20.10a. Otherwise, it performs the following tasks:

1. Obtain the midpoint between `p1` and `p2` (line 61), the midpoint between `p2` and `p3` (line 62), and the midpoint between `p3` and `p1` (line 63), as shown in Figure 20.10b.
2. Recursively invoke `displayTriangles` with a reduced order to display three smaller Sierpinski triangles (lines 66–68). Note that each small Sierpinski triangle is structurally identical to the original big Sierpinski triangle except that the order of a small triangle is one less, as shown in Figure 20.10b.

A Sierpinski triangle is displayed in a `SierpinskiTrianglePanel`. The `order` property in the inner class `SierpinskiTrianglePanel` specifies the order for the Sierpinski triangle. The `Point` class, introduced in Section 16.8, Mouse Events, represents a point on a component. The `midpoint(Point p1, Point p2)` method returns the midpoint between `p1` and `p2` (lines 72–74).



20.20 How do you obtain the midpoint between two points?

20.21 What is the base case for the `displayTriangles` method?

20.22 How many times is the `displayTriangles` method invoked for a Sierpinski triangle of order 0, order 1, order 2, and order n?

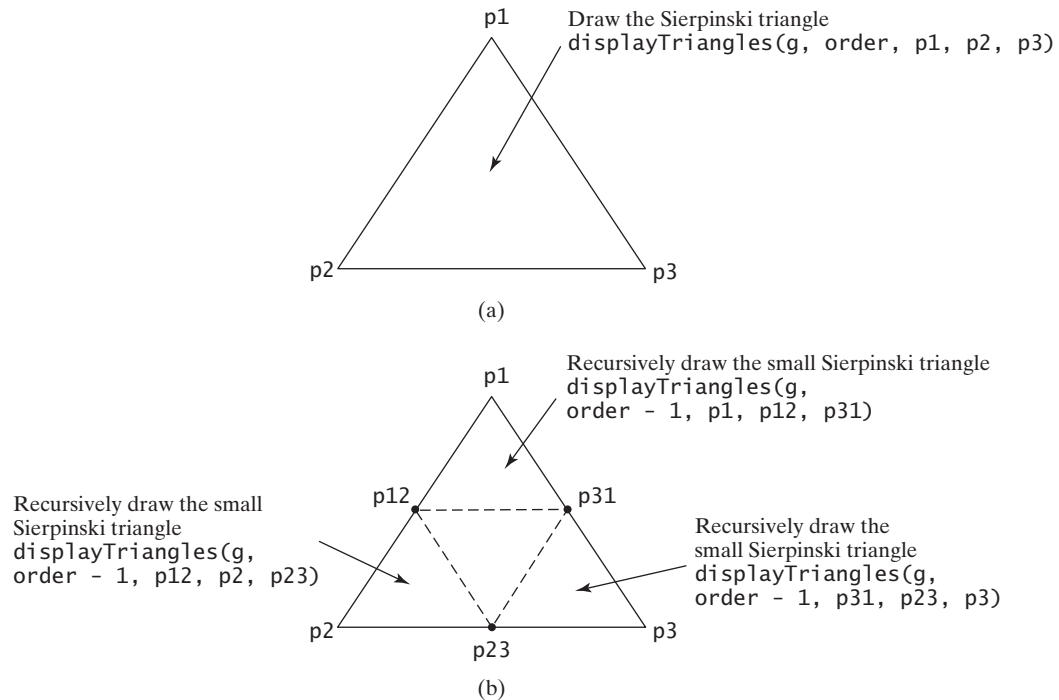


FIGURE 20.10 Drawing a Sierpinski triangle spawns calls to draw three small Sierpinski triangles recursively.

20.9 Recursion vs. Iteration

Recursion is an alternative form of program control. It is essentially repetition without a loop.



When you use loops, you specify a loop body. The repetition of the loop body is controlled by the loop control structure. In recursion, the method itself is called repeatedly. A selection statement must be used to control whether to call the method recursively or not.

Recursion bears substantial overhead. Each time the program calls a method, the system must allocate memory for all of the method's local variables and parameters. This can consume considerable memory and requires extra time to manage the memory.

Any problem that can be solved recursively can be solved nonrecursively with iterations. Recursion has some negative aspects: it uses up too much time and too much memory. Why, then, should you use it? In some cases, using recursion enables you to specify a clear, simple solution for an inherently recursive problem that would otherwise be difficult to obtain. Examples are the directory-size problem, the Towers of Hanoi problem, and the fractal problem, which are rather difficult to solve without using recursion.

The decision whether to use recursion or iteration should be based on the nature of, and your understanding of, the problem you are trying to solve. The rule of thumb is to use whichever approach can best develop an intuitive solution that naturally mirrors the problem. If an iterative solution is obvious, use it. It will generally be more efficient than the recursive option.

recursion overhead

recursion advantages

recursion or iteration?



Note

Recursive programs can run out of memory, causing a [StackOverflowError](#).

StackOverflowError

performance concern

**Tip**

If you are concerned about your program's performance, avoid using recursion, because it takes more time and consumes more memory than iteration. In general, recursion can be used to solve the inherent recursive problems such as Towers of Hanoi, recursive directories, and Sierpinski triangles.

**Check Point**

MyProgrammingLab™

20.23 Which of the following statements are true?

- Any recursive method can be converted into a nonrecursive method.
- Recursive methods take more time and memory to execute than nonrecursive methods.
- Recursive methods are *always* simpler than nonrecursive methods.
- There is always a selection statement in a recursive method to check whether a base case is reached.

20.24 What is a cause for a stack-overflow exception?

20.10 Tail Recursion

**Key Point**

A tail recursive method is efficient for reducing stack size.

A recursive method is said to be *tail recursive* if there are no pending operations to be performed on return from a recursive call, as illustrated in Figure 20.11a. However, method **B** in Figure 20.11b is not tail recursive because there are pending operations after a method call is returned.

tail recursion

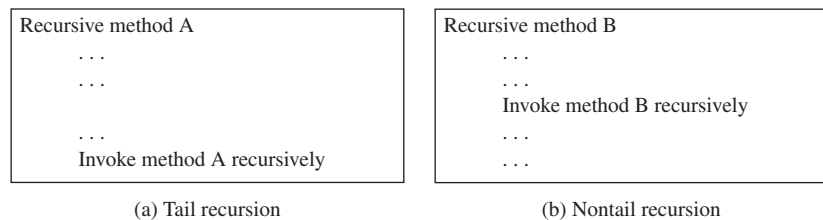


FIGURE 20.11 A tail-recursive method has no pending operations after a recursive call.

For example, the recursive `isPalindrome` method (lines 6–13) in Listing 20.4 is tail recursive because there are no pending operations after recursively invoking `isPalindrome` in line 12. However, the recursive `factorial` method (lines 16–21) in Listing 20.1 is not tail recursive, because there is a pending operation, namely multiplication, to be performed on return from each recursive call.

Tail recursion may be desirable: because the method ends when the last recursive call ends, there is no need to store the intermediate calls in the stack. Some compilers can optimize tail recursion to reduce stack size.

A nontail-recursive method can often be converted to a tail-recursive method by using auxiliary parameters. These parameters are used to contain the result. The idea is to incorporate the pending operations into the auxiliary parameters in such a way that the recursive call no longer has a pending operation. You can define a new auxiliary recursive method with the auxiliary parameters. This method may overload the original method with the same name but a different signature. For example, the `factorial` method in Listing 20.1 is written in a tail-recursive way in Listing 20.10.

LISTING 20.10 ComputeFactorialTailRecursion.java

```

1  public class ComputeFactorialTailRecursion {
2      /** Return the factorial for a specified number */
3      public static long factorial(int n) {
4          return factorial(n, 1); // Call auxiliary method
5      }
6
7      /** Auxiliary tail-recursive method for factorial */
8      private static long factorial(int n, int result) {
9          if (n == 0)
10             return result;
11         else
12             return factorial(n - 1, n * result); // Recursive call
13     }
14 }

```

original method
invoke auxiliary method

auxiliary method

recursive call

The first `factorial` method (line 3) simply invokes the second auxiliary method (line 4). The second method contains an auxiliary parameter `result` that stores the result for the factorial of `n`. This method is invoked recursively in line 12. There is no pending operation after a call is returned. The final result is returned in line 10, which is also the return value from invoking `factorial(n, 1)` in line 4.

20.25 Identify tail-recursive methods in this chapter.

20.26 Rewrite the `fib` method in Listing 20.2 using tail recursion.



MyProgrammingLab™

KEY TERMS

base case	738	recursive helper method	747
direct recursion	741	recursive method	738
indirect recursion	741	stopping condition	738
infinite recursion	741	tail recursion	758

CHAPTER SUMMARY

1. A *recursive method* is one that directly or indirectly invokes itself. For a recursive method to terminate, there must be one or more *base cases*.
2. *Recursion* is an alternative form of program control. It is essentially repetition without a loop control. It can be used to specify simple, clear solutions for inherently recursive problems that would otherwise be difficult to solve.
3. Sometimes the original method needs to be modified to receive additional parameters in order to be invoked recursively. A *recursive helper method* can be defined for this purpose.
4. Recursion bears substantial overhead. Each time the program calls a method, the system must allocate memory for all of the method's local variables and parameters. This can consume considerable memory and requires extra time to manage the memory.
5. A recursive method is said to be *tail recursive* if there are no pending operations to be performed on return from a recursive call. Some compilers can optimize tail recursion to reduce stack size.

TEST QUESTIONS

Do the test questions for this chapter online at www.cs.armstrong.edu/liang/intro9e/test.html.

MyProgrammingLab™

PROGRAMMING EXERCISES

Sections 20.2–20.3

***20.1** (*Factorial*) Using the **BigInteger** class introduced in Section 10.14, you can find the factorial for a large number (e.g., **100!**). Implement the **factorial** method using recursion. Write a program that prompts the user to enter an integer and displays its factorial.

***20.2** (*Fibonacci numbers*) Rewrite the **fib** method in Listing 20.2 using iterations. *Hint:* To compute **fib(n)** without recursion, you need to obtain **fib(n - 2)** and **fib(n - 1)** first. Let **f0** and **f1** denote the two previous Fibonacci numbers. The current Fibonacci number would then be **f0 + f1**. The algorithm can be described as follows:

```
f0 = 0; // For fib(0)
f1 = 1; // For fib(1)

for (int i = 1; i <= n; i++) {
    currentFib = f0 + f1;
    f0 = f1;
    f1 = currentFib;
}
// After the loop, currentFib is fib(n)
```

Write a test program that prompts the user to enter an index and displays its Fibonacci number.

***20.3** (*Compute greatest common divisor using recursion*) The **gcd(m, n)** can also be defined recursively as follows:

- If **m % n** is 0, **gcd(m, n)** is **n**.
- Otherwise, **gcd(m, n)** is **gcd(n, m % n)**.

Write a recursive method to find the GCD. Write a test program that prompts the user to enter two integers and displays their GCD.

20.4 (*Sum series*) Write a recursive method to compute the following series:

$$m(i) = 1 + \frac{1}{2} + \frac{1}{3} + \dots + \frac{1}{i}$$

Write a test program that displays **m(i)** for **i = 1, 2, . . . , 10**.

20.5 (*Sum series*) Write a recursive method to compute the following series:

$$m(i) = \frac{1}{3} + \frac{2}{5} + \frac{3}{7} + \frac{4}{9} + \frac{5}{11} + \frac{6}{13} + \dots + \frac{i}{2i + 1}$$

Write a test program that displays **m(i)** for **i = 1, 2, . . . , 10**.

***20.6** (*Sum series*) Write a recursive method to compute the following series:

$$m(i) = \frac{1}{2} + \frac{2}{3} + \dots + \frac{i}{i + 1}$$

Write a test program that displays **m(i)** for **i = 1, 2, . . . , 10**.

- *20.7** (*Fibonacci series*) Modify Listing 20.2, `ComputeFibonacci.java`, so that the program finds the number of times the `fib` method is called. (*Hint*: Use a static variable and increment it every time the method is called.)

Section 20.4

- *20.8** (*Print the digits in an integer reversely*) Write a recursive method that displays an `int` value reversely on the console using the following header:

```
public static void reverseDisplay(int value)
```

For example, `reverseDisplay(12345)` displays `54321`. Write a test program that prompts the user to enter an integer and displays its reversal.

- *20.9** (*Print the characters in a string reversely*) Write a recursive method that displays a string reversely on the console using the following header:

```
public static void reverseDisplay(String value)
```

For example, `reverseDisplay("abcd")` displays `dcba`. Write a test program that prompts the user to enter a string and displays its reversal.

- *20.10** (*Occurrences of a specified character in a string*) Write a recursive method that finds the number of occurrences of a specified letter in a string using the following method header:

```
public static int count(String str, char a)
```

For example, `count("Welcome", 'e')` returns `2`. Write a test program that prompts the user to enter a string and a character, and displays the number of occurrences for the character in the string.

- *20.11** (*Sum the digits in an integer using recursion*) Write a recursive method that computes the sum of the digits in an integer. Use the following method header:

```
public static int sumDigits(long n)
```

For example, `sumDigits(234)` returns `2 + 3 + 4 = 9`. Write a test program that prompts the user to enter an integer and displays its sum.

Section 20.5

- **20.12** (*Print the characters in a string reversely*) Rewrite Exercise 20.9 using a helper method to pass the substring `high` index to the method. The helper method header is:

```
public static void reverseDisplay(String value, int high)
```

- *20.13** (*Find the largest number in an array*) Write a recursive method that returns the largest integer in an array. Write a test program that prompts the user to enter a list of eight integers and displays the largest element.

- *20.14** (*Find the number of uppercase letters in a string*) Write a recursive method to return the number of uppercase letters in a string. Write a test program that prompts the user to enter a string and displays the number of uppercase letters in the string.

- *20.15** (*Occurrences of a specified character in a string*) Rewrite Exercise 20.10 using a helper method to pass the substring `high` index to the method. The helper method header is:

```
public static int count(String str, char a, int high)
```

- *20.16** (*Find the number of uppercase letters in an array*) Write a recursive method to return the number of uppercase letters in an array of characters. You need to define the following two methods. The second one is a recursive helper method.

```
public static int count(char[] chars)
public static int count(char[] chars, int high)
```

Write a test program that prompts the user to enter a list of characters in one line and displays the number of uppercase letters in the list.

- *20.17** (*Occurrences of a specified character in an array*) Write a recursive method that finds the number of occurrences of a specified character in an array. You need to define the following two methods. The second one is a recursive helper method.

```
public static int count(char[] chars, char ch)
public static int count(char[] chars, char ch, int high)
```

Write a test program that prompts the user to enter a list of characters in one line, and a character, and displays the number of occurrences of the character in the list.

Sections 20.6–20.10

- *20.18** (*Towers of Hanoi*) Modify Listing 20.8, `TowersOfHanoi.java`, so that the program finds the number of moves needed to move n disks from tower A to tower B. (*Hint*: Use a static variable and increment it every time the method is called.)
- *20.19** (*Sierpinski triangle*) Revise Listing 20.9 to develop an applet that lets the user use the + and – buttons to increase or decrease the current order by 1, as shown in Figure 20.12a. The initial order is 0. If the current order is 0, the *Decrease* button is ignored.

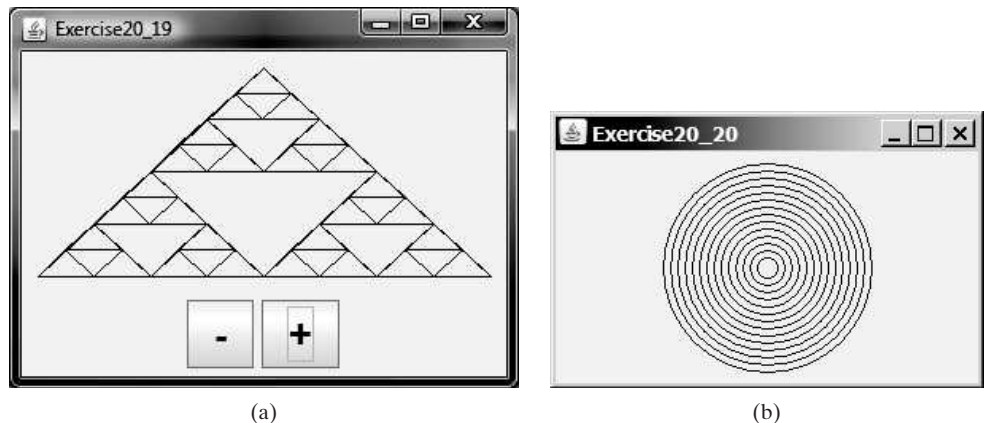


FIGURE 20.12 (a) Exercise 20.19 uses the + and – buttons to increase or decrease the current order by 1. (b) Exercise 20.20 draws ovals using a recursive method.

- *20.20** (*Display circles*) Write a Java applet that displays ovals, as shown in Figure 20.12b. The ovals are centered in the panel. The gap between two adjacent ovals is 10 pixels, and the gap between the border of the panel and the largest oval is also 10.
- *20.21** (*Decimal to binary*) Write a recursive method that converts a decimal number into a binary number as a string. The method header is:
- ```
public static String decimalToBinary(int value)
```

Write a test program that prompts the user to enter a decimal number and displays its binary equivalent.

- \*20.22** (*Decimal to hex*) Write a recursive method that converts a decimal number into a hex number as a string. The method header is:

```
public static String decimalToHex(int value)
```

Write a test program that prompts the user to enter a decimal number and displays its hex equivalent.

- \*20.23** (*Binary to decimal*) Write a recursive method that parses a binary number as a string into a decimal integer. The method header is:

```
public static int binaryToDecimal(String binaryString)
```

Write a test program that prompts the user to enter a binary string and displays its decimal equivalent.

- \*20.24** (*Hex to decimal*) Write a recursive method that parses a hex number as a string into a decimal integer. The method header is:

```
public static int hexToDecimal(String hexString)
```

Write a test program that prompts the user to enter a hex string and displays its decimal equivalent.

- \*\*20.25** (*String permutation*) Write a recursive method to print all the permutations of a string. For example, for the string **abc**, the printout is

```
abc
acb
bac
bca
cab
cba
```

(*Hint*: Define the following two methods. The second is a helper method.)

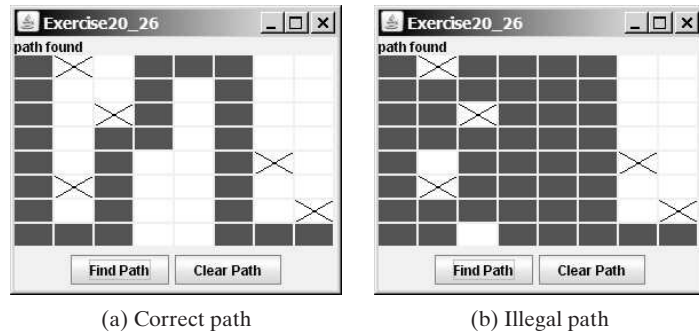
```
public static void displayPermutation(String s)
public static void displayPermutation(String s1, String s2)
```

The first method simply invokes `displayPermutation(" ", s)`. The second method uses a loop to move a character from `s2` to `s1` and recursively invokes it with a new `s1` and `s2`. The base case is that `s2` is empty and prints `s1` to the console.

Write a test program that prompts the user to enter a string and displays all its permutations.

- \*\*20.26** (*Create a maze*) Write an applet that will find a path in a maze, as shown in Figure 20.13a. The maze is represented by an  $8 \times 8$  board. The path must meet the following conditions:

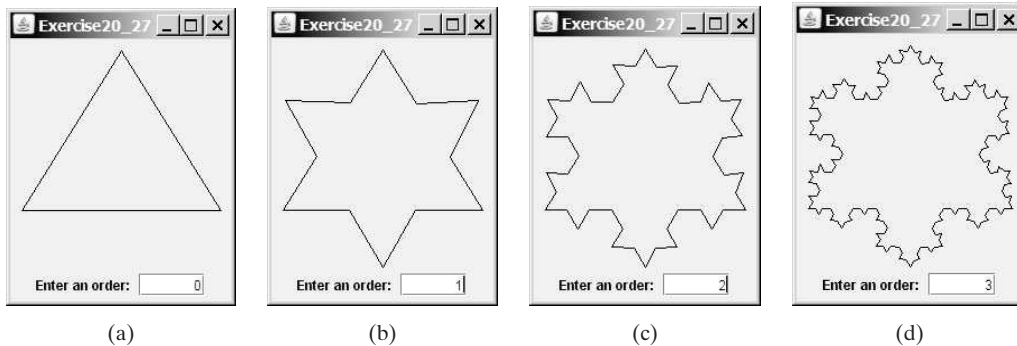
- The path is between the upper-left corner cell and the lower-right corner cell in the maze.
- The applet enables the user to place or remove a mark on a cell. A path consists of adjacent unmarked cells. Two cells are said to be adjacent if they are horizontal or vertical neighbors, but not if they are diagonal neighbors.
- The path does not contain cells that form a square. The path in Figure 20.13b, for example, does not meet this condition. (The condition makes a path easy to identify on the board.)



**FIGURE 20.13** The program finds a path from the upper-left corner to the bottom-right corner.

**\*\*20.27** (*Koch snowflake fractal*) The text presented the Sierpinski triangle fractal. In this exercise, you will write an applet to display another fractal, called the *Koch snowflake*, named after a famous Swedish mathematician. A Koch snowflake is created as follows:

1. Begin with an equilateral triangle, which is considered to be the Koch fractal of order (or level) **0**, as shown in Figure 20.14a.
2. Divide each line in the shape into three equal line segments and draw an outward equilateral triangle with the middle line segment as the base to create a Koch fractal of order **1**, as shown in Figure 20.14b.
3. Repeat Step 2 to create a Koch fractal of order **2**, **3**, . . . , and so on, as shown in Figure 20.14c–d.



**FIGURE 20.14** A Koch snowflake is a fractal starting with a triangle.

**\*\*20.28** (*Nonrecursive directory size*) Rewrite Listing 20.7, `DirectorySize.java`, without using recursion.

**\*20.29** (*Number of files in a directory*) Write a program that prompts the user to enter a directory and displays the number of the files in the directory.

**\*\*20.30** (*Find words*) Write a program that finds all occurrences of a word in all the files under a directory, recursively. Pass the parameters from the command line as follows:

```
java Exercise20_30 dirName word
```

**\*\*20.31** (*Replace words*) Write a program that replaces all occurrences of a word with a new word in all the files under a directory, recursively. Pass the parameters from the command line as follows:

```
java Exercise20_31 dirName oldWord newWord
```

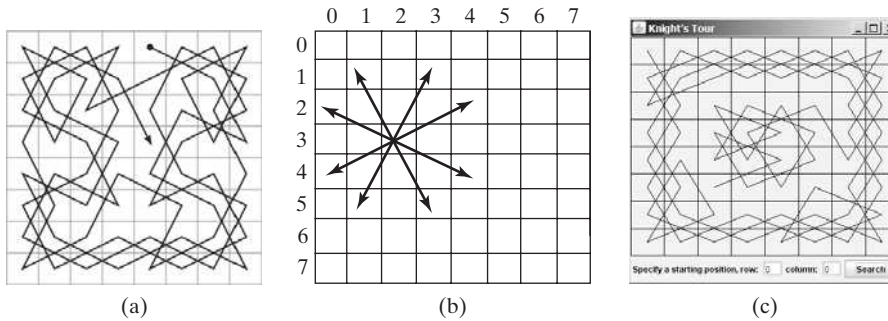


VideoNote

Search a string in a directory



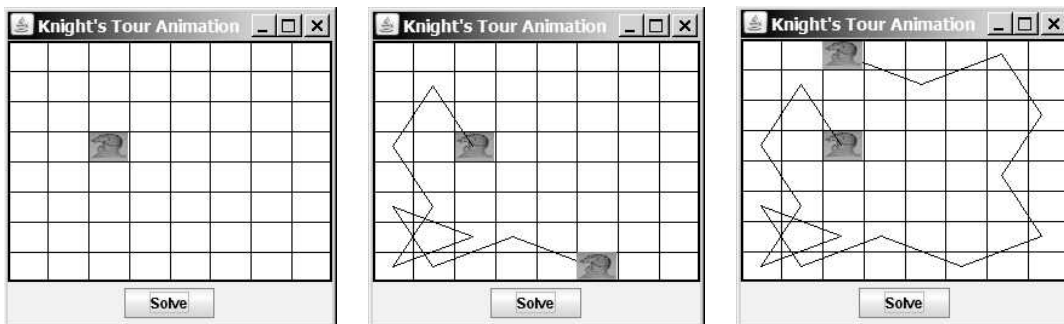
- \*\*\*20.32** (Game: *Knight's Tour*) The Knight's Tour is an ancient puzzle. The objective is to move a knight, starting from any square on a chessboard, to every other square once, as shown in Figure 20.15a. Note that the knight makes only L-shaped moves (two spaces in one direction and one space in a perpendicular direction). As shown in Figure 20.15b, the knight can move to eight squares. Write a program that displays the moves for the knight in an applet, as shown in Figure 20.15c.



**FIGURE 20.15** (a) A knight traverses all squares once. (b) A knight makes an L-shaped move. (c) An applet displays a Knight's Tour path.

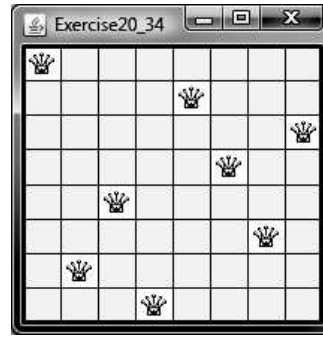
(Hint: A brute-force approach for this problem is to move the knight from one square to another available square arbitrarily. Using such an approach, your program will take a long time to finish. A better approach is to employ some heuristics. A knight has two, three, four, six, or eight possible moves, depending on its location. Intuitively, you should attempt to move the knight to the least accessible squares first and leave those more accessible squares open, so there will be a better chance of success at the end of the search.)

- \*\*\*20.33** (Game: *Knight's Tour animation*) Write an applet for the Knight's Tour problem. Your applet should let the user move a knight to any starting square and click the *Solve* button to animate a knight moving along the path, as shown in Figure 20.16.



**FIGURE 20.16** A knight traverses along the path.

- \*\*20.34** (Game: *Eight Queens*) The Eight Queens problem is to find a solution to place a queen in each row on a chessboard such that no two queens can attack each other. Write a program to solve the Eight Queens problem using recursion and display the result as shown in Figure 20.17.



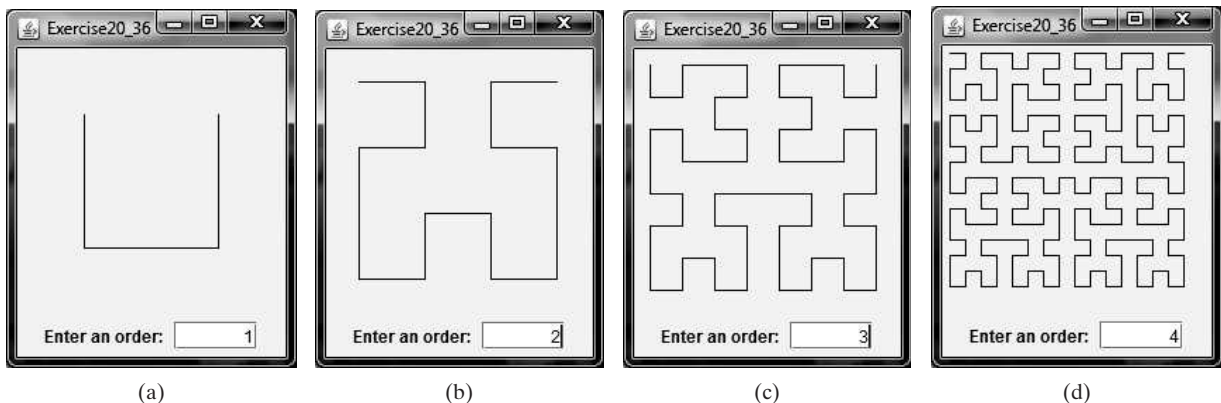
**FIGURE 20.17** The program displays a solution to the Eight Queens problem.

**\*\*20.35** (*H-tree fractal*) An H-tree (introduced at the beginning of this chapter) is a fractal defined as follows:

1. Begin with a letter H. The three lines of the H are of the same length, as shown in Figure 20.1a.
2. The letter H (in its sans-serif form, H) has four endpoints. Draw an H centered at each of the four endpoints to an H-tree of order **1**, as shown in Figure 20.1b. These Hs are half the size of the H that contains the four endpoints.
3. Repeat Step 2 to create an H-tree of order **2, 3, . . .**, and so on, as shown in Figure 20.1c–d.

Write an applet that draws an H-tree, as shown in Figure 20.1.

**\*\*20.36** (*Hilbert curve*) The Hilbert curve, first described by German mathematician David Hilbert in 1891, is a space-filling curve that visits every point in a square grid with a size of  $2 \times 2$ ,  $4 \times 4$ ,  $8 \times 8$ ,  $16 \times 16$ , or any other power of 2. Write a Java applet that displays a Hilbert curve for the specified order, as shown in Figure 20.18.



**FIGURE 20.18** A Hilbert curve with the specified order is drawn.

**20.37** (*Sierpinski triangle*) Write a program that prompts the user to enter the order and display the filled Sierpinski triangles as shown in Figure 20.19.

**\*\*20.38** (*Recursive tree*) Write an applet to display a recursive tree as shown in Figure 20.20.

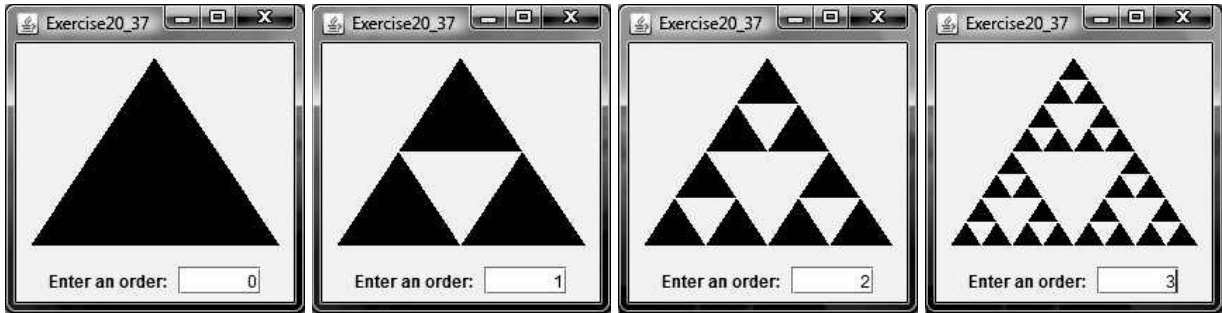


FIGURE 20.19 A filled Sierpinski triangle is displayed.

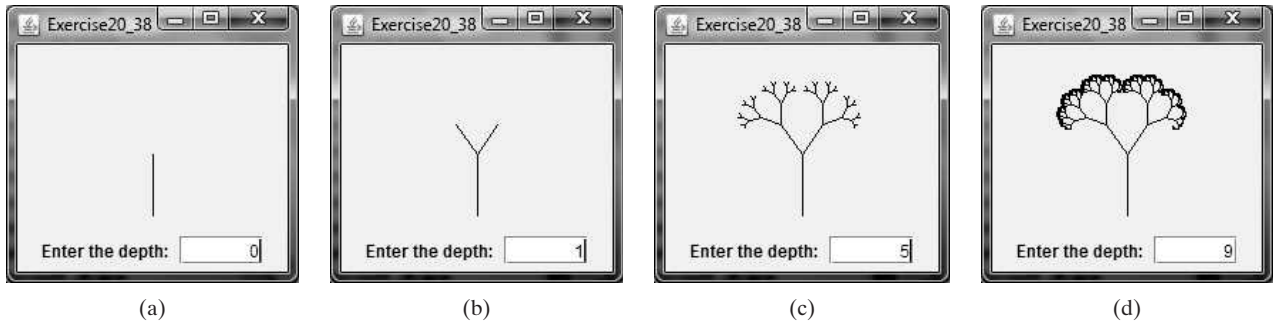


FIGURE 20.20 A recursive tree with the specified depth is drawn.

**\*\*20.39** (*Dragging the tree*) Revise Exercise 20.38 to move the tree to where the mouse is dragged.

*This page intentionally left blank*

# APPENDIXES

---

## Appendix A

Java Keywords

## Appendix B

The ASCII Character Set

## Appendix C

Operator Precedence Chart

## Appendix D

Java Modifiers

## Appendix E

Special Floating-Point Values

## Appendix F

Number Systems

## Appendix G

Bitwise Operations

*This page intentionally left blank*

## Java Keywords

The following fifty keywords are reserved for use by the Java language:

|                 |                   |                  |                     |
|-----------------|-------------------|------------------|---------------------|
| <b>abstract</b> | <b>double</b>     | <b>int</b>       | <b>super</b>        |
| <b>assert</b>   | <b>else</b>       | <b>interface</b> | <b>switch</b>       |
| <b>boolean</b>  | <b>enum</b>       | <b>long</b>      | <b>synchronized</b> |
| <b>break</b>    | <b>extends</b>    | <b>native</b>    | <b>this</b>         |
| <b>byte</b>     | <b>final</b>      | <b>new</b>       | <b>throw</b>        |
| <b>case</b>     | <b>finally</b>    | <b>package</b>   | <b>throws</b>       |
| <b>catch</b>    | <b>float</b>      | <b>private</b>   | <b>transient</b>    |
| <b>char</b>     | <b>for</b>        | <b>protected</b> | <b>try</b>          |
| <b>class</b>    | <b>goto</b>       | <b>public</b>    | <b>void</b>         |
| <b>const</b>    | <b>if</b>         | <b>return</b>    | <b>volatile</b>     |
| <b>continue</b> | <b>implements</b> | <b>short</b>     | <b>while</b>        |
| <b>default</b>  | <b>import</b>     | <b>static</b>    |                     |
| <b>do</b>       | <b>instanceof</b> | <b>strictfp*</b> |                     |

The keywords **goto** and **const** are C++ keywords reserved, but not currently used, in Java. This enables Java compilers to identify them and to produce better error messages if they appear in Java programs.

The literal values **true**, **false**, and **null** are not keywords, just like literal value **100**. However, you cannot use them as identifiers, just as you cannot use **100** as an identifier. In the code listing, we use the keyword color for **true**, **false**, and **null** to be consistent with their coloring in Java IDEs.

**assert** is a keyword added in JDK 1.4 and **enum** is a keyword added in JDK 1.5.

---

\*The **strictfp** keyword is a modifier for a method or class that enables it to use strict floating-point calculations. Floating-point arithmetic can be executed in one of two modes: *strict* or *nonstrict*. The strict mode guarantees that the evaluation result is the same on all Java Virtual Machine implementations. The nonstrict mode allows intermediate results from calculations to be stored in an extended format different from the standard IEEE floating-point number format. The extended format is machine-dependent and enables code to be executed faster. However, when you execute the code using the nonstrict mode on different JVMs, you may not always get precisely the same results. By default, the nonstrict mode is used for floating-point calculations. To use the strict mode in a method or a class, add the **strictfp** keyword in the method or the class declaration. Strict floating-point may give you slightly better precision than nonstrict floating-point, but the distinction will only affect some applications. Strictness is not inherited; that is, the presence of **strictfp** on a class or interface declaration does not cause extended classes or interfaces to be strict.

# APPENDIX B

---

## The ASCII Character Set

Tables B.1 and B.2 show ASCII characters and their respective decimal and hexadecimal codes. The decimal or hexadecimal code of a character is a combination of its row index and column index. For example, in Table B.1, the letter **A** is at row 6 and column 5, so its decimal equivalent is 65; in Table B.2, letter **A** is at row 4 and column 1, so its hexadecimal equivalent is 41.



**TABLE B.1** ASCII Character Set in the Decimal Index

|    | <i>0</i> | <i>1</i> | <i>2</i> | <i>3</i> | <i>4</i> | <i>5</i> | <i>6</i> | <i>7</i> | <i>8</i> | <i>9</i> |
|----|----------|----------|----------|----------|----------|----------|----------|----------|----------|----------|
| 0  | nul      | soh      | stx      | etx      | eot      | enq      | ack      | bel      | bs       | ht       |
| 1  | nl       | vt       | ff       | cr       | so       | si       | dle      | dcl      | dc2      | dc3      |
| 2  | dc4      | nak      | syn      | etb      | can      | em       | sub      | esc      | fs       | gs       |
| 3  | rs       | us       | sp       | !        | ”        | #        | \$       | %        | &        | '        |
| 4  | (        | )        | *        | +        | ,        | —        | .        | /        | 0        | 1        |
| 5  | 2        | 3        | 4        | 5        | 6        | 7        | 8        | 9        | :        | ;        |
| 6  | <        | =        | >        | ?        | @        | A        | B        | C        | D        | E        |
| 7  | F        | G        | H        | I        | J        | K        | L        | M        | N        | O        |
| 8  | P        | Q        | R        | S        | T        | U        | V        | W        | X        | Y        |
| 9  | Z        | [        | \        | ]        | ^        | —        | ‘        | a        | b        | c        |
| 10 | d        | e        | f        | g        | h        | i        | j        | k        | l        | m        |
| 11 | n        | o        | p        | q        | r        | s        | t        | u        | v        | w        |
| 12 | x        | y        | z        | {        |          | }        | ~        | del      |          |          |

**TABLE B.2** ASCII Character Set in the Hexadecimal Index

|   | <i>0</i> | <i>1</i> | <i>2</i> | <i>3</i> | <i>4</i> | <i>5</i> | <i>6</i> | <i>7</i> | <i>8</i> | <i>9</i> | <i>A</i> | <i>B</i> | <i>C</i> | <i>D</i> | <i>E</i> | <i>F</i> |
|---|----------|----------|----------|----------|----------|----------|----------|----------|----------|----------|----------|----------|----------|----------|----------|----------|
| 0 | nul      | soh      | stx      | etx      | eot      | enq      | ack      | bel      | bs       | ht       | nl       | vt       | ff       | cr       | so       | si       |
| 1 | dle      | dcl      | dc2      | dc3      | dc4      | nak      | syn      | etb      | can      | em       | sub      | esc      | fs       | gs       | rs       | us       |
| 2 | sp       | !        | ”        | #        | \$       | %        | &        | '        | (        | )        | *        | +        | ,        | —        | .        | /        |
| 3 | 0        | 1        | 2        | 3        | 4        | 5        | 6        | 7        | 8        | 9        | :        | ;        | <        | =        | >        | ?        |
| 4 | @        | A        | B        | C        | D        | E        | F        | G        | H        | I        | J        | K        | L        | M        | N        | O        |
| 5 | P        | Q        | R        | S        | T        | U        | V        | W        | X        | Y        | Z        | [        | \        | ]        | ^        | —        |
| 6 | ‘        | a        | b        | c        | d        | e        | f        | g        | h        | i        | j        | k        | l        | m        | n        | o        |
| 7 | p        | q        | r        | s        | t        | u        | v        | w        | x        | y        | z        | {        |          | }        | ~        | del      |

# APPENDIX C

## Operator Precedence Chart

The operators are shown in decreasing order of precedence from top to bottom. Operators in the same group have the same precedence, and their associativity is shown in the table.

| <i>Operator</i>           | <i>Name</i>                     | <i>Associativity</i> |
|---------------------------|---------------------------------|----------------------|
| <code>()</code>           | Parentheses                     | Left to right        |
| <code>()</code>           | Function call                   | Left to right        |
| <code>[]</code>           | Array subscript                 | Left to right        |
| <code>.</code>            | Object member access            | Left to right        |
| <code>++</code>           | Postincrement                   | Right to left        |
| <code>--</code>           | Postdecrement                   | Right to left        |
| <code>++</code>           | Preincrement                    | Right to left        |
| <code>--</code>           | Predecrement                    | Right to left        |
| <code>+</code>            | Unary plus                      | Right to left        |
| <code>-</code>            | Unary minus                     | Right to left        |
| <code>!</code>            | Unary logical negation          | Right to left        |
| <code>(type)</code>       | Unary casting                   | Right to left        |
| <code>new</code>          | Creating object                 | Right to left        |
| <code>*</code>            | Multiplication                  | Left to right        |
| <code>/</code>            | Division                        | Left to right        |
| <code>%</code>            | Remainder                       | Left to right        |
| <code>+</code>            | Addition                        | Left to right        |
| <code>-</code>            | Subtraction                     | Left to right        |
| <code>&lt;&lt;</code>     | Left shift                      | Left to right        |
| <code>&gt;&gt;</code>     | Right shift with sign extension | Left to right        |
| <code>&gt;&gt;&gt;</code> | Right shift with zero extension | Left to right        |
| <code>&lt;</code>         | Less than                       | Left to right        |
| <code>&lt;=</code>        | Less than or equal to           | Left to right        |
| <code>&gt;</code>         | Greater than                    | Left to right        |
| <code>&gt;=</code>        | Greater than or equal to        | Left to right        |
| <code>instanceof</code>   | Checking object type            | Left to right        |

| <i>Operator</i>         | <i>Name</i>               | <i>Associativity</i> |
|-------------------------|---------------------------|----------------------|
| <code>==</code>         | Equal comparison          | Left to right        |
| <code>!=</code>         | Not equal                 | Left to right        |
| <code>&amp;</code>      | (Unconditional AND)       | Left to right        |
| <code>^</code>          | (Exclusive OR)            | Left to right        |
| <code> </code>          | (Unconditional OR)        | Left to right        |
| <code>&amp;&amp;</code> | Conditional AND           | Left to right        |
| <code>  </code>         | Conditional OR            | Left to right        |
| <code>?:</code>         | Ternary condition         | Right to left        |
| <code>=</code>          | Assignment                | Right to left        |
| <code>+=</code>         | Addition assignment       | Right to left        |
| <code>-=</code>         | Subtraction assignment    | Right to left        |
| <code>*=</code>         | Multiplication assignment | Right to left        |
| <code>/=</code>         | Division assignment       | Right to left        |
| <code>%=</code>         | Remainder assignment      | Right to left        |

# APPENDIX D

## Java Modifiers

Modifiers are used on classes and class members (constructors, methods, data, and class-level blocks), but the **final** modifier can also be used on local variables in a method. A modifier that can be applied to a class is called a *class modifier*. A modifier that can be applied to a method is called a *method modifier*. A modifier that can be applied to a data field is called a *data modifier*. A modifier that can be applied to a class-level block is called a *block modifier*. The following table gives a summary of the Java modifiers.

| <i>Modifier</i>   | <i>Class</i> | <i>Constructor</i> | <i>Method</i> | <i>Data</i> | <i>Block</i> | <i>Explanation</i>                                                                                                   |
|-------------------|--------------|--------------------|---------------|-------------|--------------|----------------------------------------------------------------------------------------------------------------------|
| <b>(default)*</b> | √            | √                  | √             | √           | √            | A class, constructor, method, or data field is visible in this package.                                              |
| <b>public</b>     | √            | √                  | √             | √           |              | A class, constructor, method, or data field is visible to all the programs in any package.                           |
| <b>private</b>    |              | √                  | √             | √           |              | A constructor, method, or data field is only visible in this class.                                                  |
| <b>protected</b>  |              | √                  | √             | √           |              | A constructor, method, or data field is visible in this package and in subclasses of this class in any package.      |
| <b>static</b>     |              |                    | √             | √           | √            | Define a class method, a class data field, or a static initialization block.                                         |
| <b>final</b>      | √            |                    | √             | √           |              | A final class cannot be extended. A final method cannot be modified in a subclass. A final data field is a constant. |
| <b>abstract</b>   | √            |                    | √             |             |              | An abstract class must be extended. An abstract method must be implemented in a concrete subclass.                   |
| <b>native</b>     |              |                    | √             |             |              | A native method indicates that the method is implemented using a language other than Java.                           |

\*Default access doesn't have a modifier associated with it. For example: `class Test {}`

| <i>Modifier</i>     | <i>Class</i> | <i>Constructor</i> | <i>Method</i> | <i>Data</i> | <i>Block</i> | <i>Explanation</i>                                                                                      |
|---------------------|--------------|--------------------|---------------|-------------|--------------|---------------------------------------------------------------------------------------------------------|
| <b>synchronized</b> |              |                    | √             |             | √            | Only one thread at a time can execute this method.                                                      |
| <b>strictfp</b>     | √            |                    | √             |             |              | Use strict floating-point calculations to guarantee that the evaluation result is the same on all JVMs. |
| <b>transient</b>    |              |                    |               | √           |              | Mark a nonserializable instance data field.                                                             |

The modifiers default (no modifier), **public**, **private**, and **protected** are known as *visibility* or *accessibility modifiers* because they specify how classes and class members are accessed.

The modifiers **public**, **private**, **protected**, **static**, **final**, and **abstract** can also be applied to inner classes.

# APPENDIX E

## Special Floating-Point Values

Dividing an integer by zero is invalid and throws `ArithmeticException`, but dividing a floating-point value by zero does not cause an exception. Floating-point arithmetic can overflow to infinity if the result of the operation is too large for a `double` or a `float`, or underflow to zero if the result is too small for a `double` or a `float`. Java provides the special floating-point values `POSITIVE_INFINITY`, `NEGATIVE_INFINITY`, and `NaN` (Not a Number) to denote these results. These values are defined as special constants in the `Float` class and the `Double` class.

If a positive floating-point number is divided by zero, the result is `POSITIVE_INFINITY`. If a negative floating-point number is divided by zero, the result is `NEGATIVE_INFINITY`. If a floating-point zero is divided by zero, the result is `NaN`, which means that the result is undefined mathematically. The string representations of these three values are `Infinity`, `-Infinity`, and `NaN`. For example,

```
System.out.print(1.0 / 0); // Print Infinity
System.out.print(-1.0 / 0); // Print -Infinity
System.out.print(0.0 / 0); // Print NaN
```

These special values can also be used as operands in computations. For example, a number divided by `POSITIVE_INFINITY` yields a positive zero. Table E.1 summarizes various combinations of the `/`, `*`, `%`, `+`, and `-` operators.

**TABLE E.1** Special Floating-Point Values

| <i>x</i>   | <i>y</i>   | <i>x/y</i> | <i>x*y</i> | <i>x%y</i> | <i>x + y</i> | <i>x - y</i> |
|------------|------------|------------|------------|------------|--------------|--------------|
| Finite     | ± 0.0      | ± infinity | ± 0.0      | NaN        | Finite       | Finite       |
| Finite     | ± infinity | ± 0.0      | ± 0.0      | x          | ± infinity   | infinity     |
| ± 0.0      | ± 0.0      | NaN        | ± 0.0      | NaN        | ± 0.0        | ± 0.0        |
| ± infinity | Finite     | ± infinity | ± 0.0      | NaN        | ± infinity   | ± infinity   |
| ± infinity | ± infinity | NaN        | ± 0.0      | NaN        | ± infinity   | infinity     |
| ± 0.0      | ± infinity | ± 0.0      | NaN        | ± 0.0      | ± infinity   | ± 0.0        |
| NaN        | Any        | NaN        | NaN        | NaN        | NaN          | NaN          |
| Any        | NaN        | NaN        | NaN        | NaN        | NaN          | NaN          |



### Note

If one of the operands is NaN, the result is NaN.

## Number Systems

### F.1 Introduction

Computers use binary numbers internally, because computers are made naturally to store and process 0s and 1s. The binary number system has two digits, 0 and 1. A number or character is stored as a sequence of 0s and 1s. Each 0 or 1 is called a *bit* (binary digit).

binary numbers

In our daily life we use decimal numbers. When we write a number such as 20 in a program, it is assumed to be a decimal number. Internally, computer software is used to convert decimal numbers into binary numbers, and vice versa.

decimal numbers

We write computer programs using decimal numbers. However, to deal with an operating system, we need to reach down to the “machine level” by using binary numbers. Binary numbers tend to be very long and cumbersome. Often hexadecimal numbers are used to abbreviate them, with each hexadecimal digit representing four binary digits. The hexadecimal number system has 16 digits: 0–9 and A–F. The letters A, B, C, D, E, and F correspond to the decimal numbers 10, 11, 12, 13, 14, and 15.

hexadecimal number

The digits in the decimal number system are 0, 1, 2, 3, 4, 5, 6, 7, 8, and 9. A decimal number is represented by a sequence of one or more of these digits. The value that each digit represents depends on its position, which denotes an integral power of 10. For example, the digits 7, 4, 2, and 3 in decimal number 7423 represent 7000, 400, 20, and 3, respectively, as shown below:

$$\begin{array}{|c|c|c|c|} \hline 7 & 4 & 2 & 3 \\ \hline \end{array} = 7 \times 10^3 + 4 \times 10^2 + 2 \times 10^1 + 3 \times 10^0$$

$$10^3 \ 10^2 \ 10^1 \ 10^0 = 7000 + 400 + 20 + 3 = 7423$$

The decimal number system has ten digits, and the position values are integral powers of 10. We say that 10 is the *base* or *radix* of the decimal number system. Similarly, since the binary number system has two digits, its base is 2, and since the hex number system has 16 digits, its base is 16.

base  
radix

If 1101 is a binary number, the digits 1, 1, 0, and 1 represent  $1 \times 2^3$ ,  $1 \times 2^2$ ,  $0 \times 2^1$ , and  $1 \times 2^0$ , respectively:

$$\begin{array}{|c|c|c|c|} \hline 1 & 1 & 0 & 1 \\ \hline \end{array} = 1 \times 2^3 + 1 \times 2^2 + 0 \times 2^1 + 1 \times 2^0$$

$$2^3 \ 2^2 \ 2^1 \ 2^0 = 8 + 4 + 0 + 1 = 13$$

If 7423 is a hex number, the digits 7, 4, 2, and 3 represent  $7 \times 16^3$ ,  $4 \times 16^2$ ,  $2 \times 16^1$ , and  $3 \times 16^0$ , respectively:

$$\begin{array}{|c|c|c|c|} \hline 7 & 4 & 2 & 3 \\ \hline \end{array} = 7 \times 16^3 + 4 \times 16^2 + 2 \times 16^1 + 3 \times 16^0$$

$$16^3 \ 16^2 \ 16^1 \ 16^0 = 28672 + 1024 + 32 + 3 = 29731$$

## F.2 Conversions Between Binary and Decimal Numbers

binary to decimal

Given a binary number  $b_n b_{n-1} b_{n-2} \dots b_2 b_1 b_0$ , the equivalent decimal value is

$$b_n \times 2^n + b_{n-1} \times 2^{n-1} + b_{n-2} \times 2^{n-2} + \dots + b_2 \times 2^2 + b_1 \times 2^1 + b_0 \times 2^0$$

Here are some examples of converting binary numbers to decimals:

| Binary   | Conversion Formula                                                                                                      | Decimal |
|----------|-------------------------------------------------------------------------------------------------------------------------|---------|
| 10       | $1 \times 2^1 + 0 \times 2^0$                                                                                           | 2       |
| 1000     | $1 \times 2^3 + 0 \times 2^2 + 0 \times 2^1 + 0 \times 2^0$                                                             | 8       |
| 10101011 | $1 \times 2^7 + 0 \times 2^6 + 1 \times 2^5 + 0 \times 2^4 + 1 \times 2^3 + 0 \times 2^2 + 1 \times 2^1 + 1 \times 2^0$ | 171     |

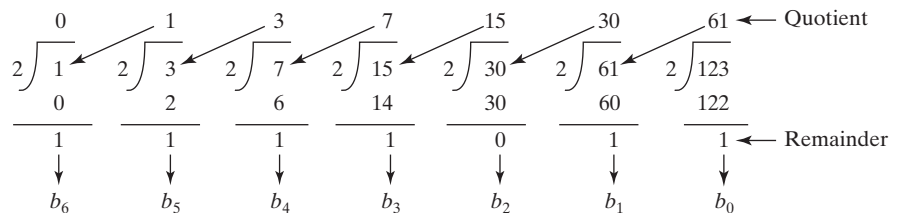
decimal to binary

To convert a decimal number  $d$  to a binary number is to find the bits  $b_n, b_{n-1}, b_{n-2}, \dots, b_2, b_1, b_0$  such that

$$d = b_n \times 2^n + b_{n-1} \times 2^{n-1} + b_{n-2} \times 2^{n-2} + \dots + b_2 \times 2^2 + b_1 \times 2^1 + b_0 \times 2^0$$

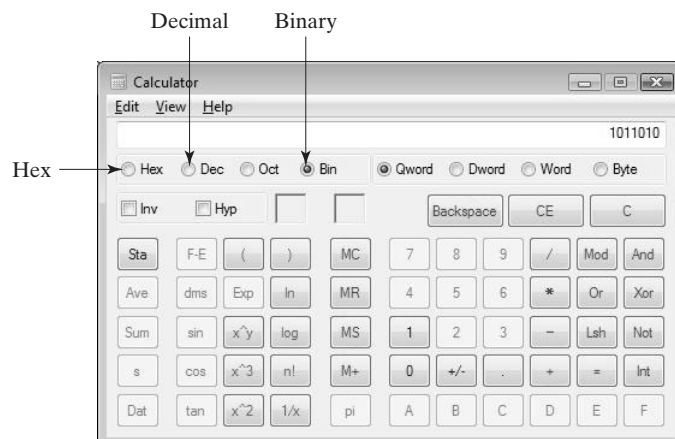
These bits can be found by successively dividing  $d$  by 2 until the quotient is 0. The remainders are  $b_0, b_1, b_2, \dots, b_{n-2}, b_{n-1},$  and  $b_n$ .

For example, the decimal number 123 is 1111011 in binary. The conversion is done as follows:



### Tip

The Windows Calculator, as shown in Figure F.1, is a useful tool for performing number conversions. To run it, search for *Calculator* from the *Start* button and launch Calculator, then under *View* select *Scientific*.



**FIGURE F.1** You can perform number conversions using the Windows Calculator.



## F.3 Conversions Between Hexadecimal and Decimal Numbers

Given a hexadecimal number  $h_n h_{n-1} h_{n-2} \dots h_2 h_1 h_0$ , the equivalent decimal value is

hex to decimal

$$h_n \times 16^n + h_{n-1} \times 16^{n-1} + h_{n-2} \times 16^{n-2} + \dots + h_2 \times 16^2 + h_1 \times 16^1 + h_0 \times 16^0$$

Here are some examples of converting hexadecimal numbers to decimals:

| Hexadecimal | Conversion Formula                                                  | Decimal |
|-------------|---------------------------------------------------------------------|---------|
| 7F          | $7 \times 16^1 + 15 \times 16^0$                                    | 127     |
| FFFF        | $15 \times 16^3 + 15 \times 16^2 + 15 \times 16^1 + 15 \times 16^0$ | 65535   |
| 431         | $4 \times 16^2 + 3 \times 16^1 + 1 \times 16^0$                     | 1073    |

To convert a decimal number  $d$  to a hexadecimal number is to find the hexadecimal digits  $h_n, h_{n-1}, h_{n-2}, \dots, h_2, h_1$ , and  $h_0$  such that

decimal to hex

$$d = h_n \times 16^n + h_{n-1} \times 16^{n-1} + h_{n-2} \times 16^{n-2} + \dots + h_2 \times 16^2 + h_1 \times 16^1 + h_0 \times 16^0$$

These numbers can be found by successively dividing  $d$  by 16 until the quotient is 0. The remainders are  $h_0, h_1, h_2, \dots, h_{n-2}, h_{n-1}$ , and  $h_n$ .

For example, the decimal number 123 is 7B in hexadecimal. The conversion is done as follows:

$$\begin{array}{r}
 \begin{array}{r}
 0 \\
 16 \overline{) 7} \\
 \underline{0} \\
 7
 \end{array}
 \quad
 \begin{array}{r}
 7 \\
 16 \overline{) 123} \\
 \underline{112} \\
 11
 \end{array}
 \quad
 \begin{array}{l}
 \longleftarrow \text{Quotient} \\
 \\
 \longleftarrow \text{Remainder}
 \end{array}
 \end{array}$$

$\downarrow$                        $\downarrow$   
 $h_1$                        $h_0$

## F.4 Conversions Between Binary and Hexadecimal Numbers

To convert a hexadecimal to a binary number, simply convert each digit in the hexadecimal number into a four-digit binary number, using Table F.1.

hex to binary

For example, the hexadecimal number 7B is 1111011, where 7 is 111 in binary, and B is 1011 in binary.

To convert a binary number to a hexadecimal, convert every four binary digits from right to left in the binary number into a hexadecimal number.

binary to hex

For example, the binary number 1110001101 is 38D, since 1101 is D, 1000 is 8, and 11 is 3, as shown below.

$$\begin{array}{cccccccc}
 1 & 1 & 1 & 0 & 0 & 0 & 1 & 1 & 0 & 1 \\
 \boxed{\phantom{0000}} & \boxed{\phantom{0000}} & \boxed{\phantom{0000}} & & & & & & & \\
 \downarrow & \downarrow & \downarrow & & & & & & & \\
 3 & 8 & D & & & & & & & 
 \end{array}$$

**TABLE F.1** Converting Hexadecimal to Binary

| <i>Hexadecimal</i> | <i>Binary</i> | <i>Decimal</i> |
|--------------------|---------------|----------------|
| 0                  | 0000          | 0              |
| 1                  | 0001          | 1              |
| 2                  | 0010          | 2              |
| 3                  | 0011          | 3              |
| 4                  | 0100          | 4              |
| 5                  | 0101          | 5              |
| 6                  | 0110          | 6              |
| 7                  | 0111          | 7              |
| 8                  | 1000          | 8              |
| 9                  | 1001          | 9              |
| A                  | 1010          | 10             |
| B                  | 1011          | 11             |
| C                  | 1100          | 12             |
| D                  | 1101          | 13             |
| E                  | 1110          | 14             |
| F                  | 1111          | 15             |

**Note**

Octal numbers are also useful. The octal number system has eight digits, 0 to 7. A decimal number 8 is represented in the octal system as 10.

Here are some good online resources for practicing number conversions:

- [http://forums.cisco.com/CertCom/game/binary\\_game\\_page.htm](http://forums.cisco.com/CertCom/game/binary_game_page.htm)
- <http://people.sinclair.edu/nickreeder/Flash/binDec.htm>
- <http://people.sinclair.edu/nickreeder/Flash/binHex.htm>



MyProgrammingLab™

- F.1** Convert the following decimal numbers into hexadecimal and binary numbers:  
100; 4340; 2000
- F.2** Convert the following binary numbers into hexadecimal and decimal numbers:  
1000011001; 100000000; 100111
- F.3** Convert the following hexadecimal numbers into binary and decimal numbers:  
FEFA9; 93; 2000

## Bitwise Operations

To write programs at the machine-level, often you need to deal with binary numbers directly and perform operations at the bit-level. Java provides the bitwise operators and shift operators defined in Table G.1.

The bit operators apply only to integer types (**byte**, **short**, **int**, and **long**). A character involved in a bit operation is converted to an integer. All bitwise operators can form bitwise assignment operators, such as **=**, **|=**, **<<=**, **>>=**, and **>>>=**.

**TABLE G.1**

| <i>Operator</i>     | <i>Name</i>                              | <i>Example<br/>(using bytes in the example)</i>                        | <i>Description</i>                                                                                                                                         |
|---------------------|------------------------------------------|------------------------------------------------------------------------|------------------------------------------------------------------------------------------------------------------------------------------------------------|
| <b>&amp;</b>        | Bitwise AND                              | 10101110 & 10010010<br>yields 10000010                                 | The AND of two corresponding bits yields a 1 if both bits are 1.                                                                                           |
| <b> </b>            | Bitwise inclusive OR                     | 10101110   10010010<br>yields 10111110                                 | The OR of two corresponding bits yields a 1 if either bit is 1.                                                                                            |
| <b>^</b>            | Bitwise exclusive OR                     | 10101110 ^ 10010010<br>yields 00111100                                 | The XOR of two corresponding bits yields a 1 only if two bits are different.                                                                               |
| <b>~</b>            | One's complement                         | ~10101110 yields<br>01010001                                           | The operator toggles each bit from 0 to 1 and from 1 to 0.                                                                                                 |
| <b>&lt;&lt;</b>     | Left shift                               | 10101110 << 2 yields<br>10111000                                       | The operator shifts bits in the first operand left by the number of bits specified in the second operand, filling with 0s on the right.                    |
| <b>&gt;&gt;</b>     | Right shift with sign extension          | 10101110 >> 2 yields<br>11101011<br>00101110 >> 2 yields<br>00001011   | The operator shifts bit in the first operand right by the number of bits specified in the second operand, filling with the highest (sign) bit on the left. |
| <b>&gt;&gt;&gt;</b> | Unsigned right shift with zero extension | 10101110 >>> 2 yields<br>00101011<br>00101110 >>> 2 yields<br>00001011 | The operator shifts bit in the first operand right by the number of bits specified in the second operand, filling with 0s on the left.                     |

*This page intentionally left blank*

# INDEX

## Symbols

- (decrement operator), 54–56
- (subtraction operator), 46, 50
- . (dot operator), 23, 304
- . (object member access operator), 304, 427
- / (division operator), 46, 50
- //, in line comment syntax, 25
- /\*, in block comment syntax, 25
- /\*\*.\*/ (Javadoc comment syntax), 25
- /= (division assignment operator), 53–54
- ;; (semicolons), common errors, 93
- \ (backslash character), as directory separator, 542
- \ (escape characters), 63–64
- || (or logical operator), 102–105
- + (addition operator), 46, 50
- + (string concatenation operator), 38, 340
- ++ (increment operator), 54–56
- += (addition assignment operator), augmented, 53–54
- = (assignment operator), 42–43, 53–54
- = (equals operator), 82
- = (subtraction assignment operator), 53–54
- == (comparison operator), 82, 430
- == (equal to operator), 82
- ! (not logical operator), 102–105
- != (not equal to comparison operator), 82
- \$ (dollar sign character), use in source code, 40
- % (remainder or modulo operator), 46, 50
- %= (remainder assignment operator), 53–54
- && (and logical operator), 102–105
- ( ) (parentheses), 18, 203
- \* (multiplication operator), 19, 46, 50
- \*= (multiplication assignment operator), 53–54
- ^ (exclusive or logical operator), 102–105
- { } (curly braces), 17–18, 85, 93
- < (less than comparison operator), 82
- <= (less than or equal to comparison operator), 82
- > (greater than comparison operator), 82
- >= (greater than or equal to comparison operator), 82

## A

- abs** method, **Math** class, 199–200, 588
- Absolute file name, 541
- Abstract classes
  - case study: abstract number class, 565–567
  - case study: **Calendar** and **GregorianCalendar** classes, 567–568
  - characteristics of, 564–565
  - Circle.java** and **Rectangle.java** examples, 562
  - compared with interfaces, 581–584

- Component** and **JComponent** as, 447
- FontMetrics** as, 493
- GeometricObject.java** example, 560–562
- InputStream** and **OutputStream** classes, 712–713
- interfaces compared to, 570
- key terms, 590
- overview of, 559–560
- questions and exercises, 590–598
- Rational.java** example, 586–589
- reasons for using abstract methods, 562
- summary, 590
- TestCalendar.java** example, 568–570
- TestGeometricObject.java** example, 562–563
- TestRationalClass.java** example, 585–586
- Abstract data type (ADT), 375
- Abstract methods
  - characteristics of, 564
  - GeometricObject** class, 561–562
  - implementing in subclasses, 560
  - in interfaces, 570
  - in **Number** class, 588
  - reasons for using, 562–563
- abstract** modifier, for denoting abstract methods, 560
- Abstract number class
  - LargestNumbers.java**, 566–567
  - overview of, 565–567
- Abstract Windows Toolkit. *see* AWT (Abstract Windows Toolkit)
- AbstractButton** class
  - alignment, 470
  - overview of, 468–469
- Abstraction
  - classes, 375–376
  - methods, 203–204
- Accessor methods. *see* Getter (accessor) methods
- acos** method, trigonometry, 197–198
- ActionEvents**
  - GUI components firing, 640
  - JComboBox** class, 647, 650
  - processing with event handlers, 604–605
  - Timer** class firing, 625–626
- ActionListener** interface
  - animation using **Timer** class, 625
  - ControlCircle.java**, 607–608
  - DetectSourceDemo.java**, 613–614
  - event handlers and register listeners and, 604–605
  - overview of, 600–602
- Actions (behaviors), object, 296
- Activation records, invoking methods and, 182
- Actual parameters, defining methods and, 179
- Ada, high-level languages, 11

- add** method, for adding components to frames, 450–451
- addActionListener** method, 600
- Addition (+) operator, 46, 50
- Addition (+=) assignment operator, augmented assignment operators, 53–54
- Adjustment listeners, 656
- ADT (abstract data type), 375
- Aggregating classes, 382
- Aggregating objects, 382
- Aggregation relationships, objects, 382–383
- AIFF audio files, 693
- Algorithms, 34
- Alignment, **JButton** class and, 470
- Ambiguous invocation, of methods, 195
- American Standard Code for Information Interchange (ASCII). *see* ASCII (American Standard Code for Information Interchange)
- Anagrams, 364
- And (&&) logical operator, 102–105
- Android phones, use of Java on, 15
- Animation
  - AnimationDemo.java**, 626–628
  - ClockAnimation.java**, 628–629
  - using **Timer** class for, 625–626
- Anonymous arrays, 238
- Anonymous class listeners
  - AnonymousListenerDemo.java**, 610–612
  - ListDemo.java**, 653
  - MoveMessageDemo.java**, 619
  - overview of, 609–610
- Anonymous objects, 305
- APIs (Application Program Interfaces), 16
- Applet** class
  - developing applets, 672
  - as top-level container, 447
- Applet Viewer utility, 675
- <applet>** tag, HTML, 673
- Applets
  - case study: bouncing ball, 683–686
  - case study: national flags and anthems, 695–697
  - case study: tic-tac-toe game, 686–688
  - containers, 447, 677
  - developing, 672
  - DisplayImagePlayAudio.java**, 694
  - DisplayImageWithURL.java**, 692–693
  - DisplayLabel.html**, 673–674
  - DisplayLabel.java**, 672–673, 676–677
  - DisplayMessageApp.java**, 681–683
  - DisplayMessage.html**, 679–680
  - DisplayMessage.java**, 680–681
  - enabling to run as application, 676–677
  - HTML **<applet>** tag, 673
  - Java, 14
  - key terms, 697
  - life-cycle methods, 677–678
  - locating resources using **URL** class, 691–692
  - overview of, 671–672
  - passing strings to, 679
  - playing audio files, 693–694
  - questions and exercises, 698–708
  - security restrictions, 675–676
  - summary, 697–698
  - TicTacToe.java**, 688–691
  - viewing from Web browser, 674–675
  - viewing with Applet Viewer utility, 675
- appletviewer** command, 675
- Application, enabling applets to run as, 676–677
- Application Program Interfaces (APIs), 16
- Apps, developing on Web servers, 14
- Archive** attribute, applets, 674
- Arcs, drawing, 488–490
- Arguments
  - defining methods and, 179
  - passing by values, 186–189
  - receiving string arguments from command line, 358–359
  - variable-length argument lists, 244–245
- ArithmeticException** class, 521
- Arithmetic/logic units, CPU components, 3
- Array initializers, 227
- Array variables, 226
- arraycopy** method, **System** class, 236
- ArrayIndexOutOfBoundsException**, 230
- ArrayList** class
  - case study: custom stack class, 436–437
  - cloning arrays, 578
  - creating and adding numbers to array lists, 566–567
  - DistinctNumbers.java** example, 434–436
  - storing list of objects in, 430–431
  - TestArrayList.java** example, 431–434
- Arrays, multi-dimensional
  - case study: daily temperature and humidity, 278–279
  - case study: guessing birthdays, 279
  - overview of, 277–278
  - questions and exercises, 281–294
  - summary, 281
- Arrays, single-dimensional
  - ArrayList** class, 433–434
  - Arrays class, 252–253
  - case study: counting occurrences of letters, 241–244
  - case study: deck of cards, 234–236
  - case study: lotto numbers, 231–234
  - constructing strings from, 336
  - converting strings to/from, 343–344
  - copying, 236–237
  - creating, 225–226, 574–576
  - declaring, 225
  - for-each** loops, 229–231
  - indexed variables, 226–227
  - initializers, 227
  - key terms, 253
  - of objects, 326–328
  - overview of, 223–225

- passing to methods, 237–240
- processing, 227–229
- questions and exercises, 255–262
- returning from methods, 240–241
- searching, 245–248
- serializing, 728–729
- size and default values, 226
- sorting, 248–252, 574–576
- summary, 253–254
- treating as objects in Java, 304
- variable-length argument lists, 244–245
- Arrays, two-dimensional
  - case study: finding closest pair of points, 272–273
  - case study: grading multiple-choice test, 270–272
  - case study: Sudoku, 274–277
  - declaring variables and creating two-dimensional arrays, 264–265
  - obtaining length of two-dimensional arrays, 265–266
  - overview of, 263–264
  - passing to methods to two-dimensional arrays, 269–270
  - processing two-dimensional arrays, 267–269
  - questions and exercises, 281–294
  - ragged arrays, 266–267
  - summary, 281
- Arrays** class, 252–253
- Arrows keys, on keyboards, 8
- Ascent, in text fonts, 493
- ASCII (American Standard Code for Information Interchange)
  - character data type (**char**) and, 63
  - data input and output streams, 717
  - encoding scheme, 4
  - text encoding, 710
  - text I/O vs. binary I/O, 711
- asin** method, trigonometry, 197–198
- Assemblers, 10
- Assembly language, 10
- Assignment operator (=)
  - augmented, 53–54
  - overview of, 42–43
- Assignment statements (assignment expressions)
  - assigning value to variables, 36
  - overview of, 42–43
- Associativity, of operators, 116
- atan** method, trigonometry, 197–198
- Attributes, object, 296
- AU files, audio formats, 693
- Audio files
  - applets for playing, 693–694
  - case study: national flags and anthems, 695–697
  - DisplayImagePlayAudio.java**, 694
- AudioClip** objects, 693–694
- Autoboxing/Autounboxing, 396–397
- AWT (Abstract Windows Toolkit)
  - Applet** class, 447, 672
  - Color** class, 460–462
  - Component** class. *see* **Component** class
  - Container** class. *see* Containers/**Container** class
  - Date** class, 308–309, 567–568
  - Dialog** class, 447
  - Dimension** class, 448
  - Error** class, 524, 526
  - event classes in, 603
  - EventObject** class, 602–603, 605
  - exceptions. *see* **Exception** class
  - FigurePanel** class, 485–488
  - File** class, 541–543, 710
  - FlowLayout** class. *see* **FlowLayout** class
  - Font** class, 461–462
  - Frame** class, 447
  - GeometricObject** class, 560–563
  - Graphics** class. *see* **Graphics** class
  - GregorianCalendar** class in. *see* **GregorianCalendar** class
  - GridLayout** class. *see* **GridLayout** class
  - GuessDate** class, 388–391
  - IllegalArgumentException** class, 527
  - Image** class, 504
  - ImageViewer** class, 506–508
  - InputMismatchException** class, 522–523, 547
  - KeyEvent** class, 621
  - LayoutManager** class, 448
  - MalformedURLException** class, 551
  - MessagePanel** class, 495–497
  - MouseEvent** class, 617–619
  - Point** class, 617–618
  - Polygon** class, 490
  - Scanner** class. *see* **Scanner** class
  - String** class, 336
  - Swing vs., 446
- B**
  - Babylonian method, 217
  - Background color, setting, 463
  - Backslash character (\), as directory separator, 542
  - Base cases, in recursion, 744
  - BASIC, high-level languages, 11
  - Bean machine game, 258–259, 514, 633
  - beginIndex** method, for obtaining substrings from strings, 341
  - Behaviors (actions), object, 296
  - Behind the scene evaluation, expressions, 116
  - BigDecimal** class, 397–398, 565
  - Binary
    - files, 710
    - machine language as binary code, 9–10
    - operators, 47
    - searches, 246–248, 748–749
  - binary digits (Bits), 4
  - Binary I/O
    - BufferedInputStream** and **BufferedOutputStream** classes, 719–722
    - characters and strings in, 716

- Binary I/O (*continued*)
    - classes, 712–713
    - [DataInputStream](#) and [DataOutputStream](#) classes, 716–718
    - [DetectEndOfFile.java](#), 719
    - [FileInputStream](#) and [FileOutputStream](#) classes, 713–714
    - [FilterInputStream](#) and [FilterOutputStream](#) classes, 716
    - overview of, 710
    - [TestDataStream.java](#), 718–719
    - [TestFileStream.java](#), 714–716
    - vs. text I/O, 711–712
  - Binary numbers
    - converting to decimal, 763
    - converting to/from, 364
  - [binarySearch](#) method, [Arrays](#) class, 252–253
  - Bits (binary digits), 4
  - Block comments, in [Welcome.java](#), 17
  - Block style, programming style, 25–26
  - Blocks, in [Welcome.java](#), 17
  - BMI (Body Mass Index), 97–99, 379–382
  - Boolean accessor method, 320
  - boolean** data type
    - [java.util.Random](#), 309–310
    - overview of, 82–84
  - Boolean expressions
    - case study: determining leap year, 105–106
    - conditional expressions, 111–112
    - defined, 82
    - if** statements and, 84–85
    - if-else** statements, 89–91
    - writing, 95
  - Boolean literals, 83
  - Boolean values
    - defined, 82
    - as format specifier, 113
    - inability to cast, 104
    - logical operators and, 101–102
    - redundancy in testing, 94
  - Boolean variables
    - assigning, 95
    - overview of, 83
    - redundancy in testing, 94
  - [BorderLayout](#) class
    - overview of, 456
    - properties of, 457
    - [ShowBorderLayout.java](#) example, 456–457
  - Borders
    - [JComponent](#) class, 463
    - setting, 463–464
    - sharing, 466
  - Bottom-up implementation, 205–207
  - Boxing, converting wrapper object to primitive value, 396
  - Braces. *see* Curly braces (**{}**)
  - break** statements
    - controlling loops, 159–162
    - using with **switch** statements, 109
  - Breakpoints, setting for debugging, 120
  - Bubble sorts, 258
  - [BufferedInputStream](#) and [BufferedOutputStream](#) classes, 719–722
  - Bugs (logic errors), 27–28, 119–120
  - Bus, function of, 2–3
  - [ButtonListener](#) class, 617
  - Buttons
    - adding to [BorderLayout](#), 457
    - creating, 311, 451
    - grouping, 641
    - icons used with, 469
    - image icons displayed as, 466
    - [JButton](#) class. *see* [JButton](#) class
    - [JRadioButton](#) class. *see* [JRadioButton](#) class
    - text positions, 470–471
    - types of, 468
  - byte** type, numeric types, 45
  - Bytecode
    - translating Java source file into, 20–21
    - verifier, 22
  - Bytes
    - defined, 4
    - measuring storage capacity in, 5
- ## C
- C, high-level languages, 11
  - C++, high-level languages, 11
  - Cable modems, 8
  - [Calendar](#) class, 567–568
  - Call stacks
    - displaying in debugging, 120
    - invoking methods and, 182
  - Calling
    - methods, 180–182
    - objects, 305
  - [canRead](#) method, [File](#) class, 542–543
  - [canWrite](#) method, [File](#) class, 542–543
  - [capacity](#) method, [StringBuilder](#) class, 355–356
  - Case sensitivity
    - identifiers and, 40
    - in [Welcome.java](#), 18
  - Casting. *see* Type casting
  - Casting objects
    - [CastingDemo.java](#) example, 426–429
    - overview of, 425–426
  - Catching exceptions
    - catch** block omitted when **finally** clause is used, 535
    - [CircleWithException.java](#) example, 532
    - [InputMismatchExceptionDemo.java](#) example, 522
    - [QuotientWithException.java](#) example, 520–521
    - try-catch** blocks, 527–529
  - CDs (compact discs), as storage device, 6
  - Cells
    - in Sudoku grid, 274
    - in tic-tac-toe case study, 687–691



- Celsius, converting to/from Fahrenheit, 50–51, 213
- Chained exceptions, 537–538
- Character** class, 350–351
- Characters/ character data type (**char**)
  - applying numeric operators to, 201–202
  - in binary I/O, 716–717
  - case study: counting monetary units, 65–68
  - case study: ignoring nonalphanumeric characters when
    - checking palindromes, 356–358
  - casting to/from numeric types, 63–65
  - Character** class, 350–351
  - comparing, 82
  - constructing strings from arrays of, 336
  - converting to strings, 344
  - CountEachLetter.java** example, 351–353
  - escape characters, 63–64
  - finding, 342–343
  - overview of, 62
  - RandomCharacter.java**, 202
  - retrieving in strings, 339–340
  - TestRandomCharacter.java**, 202–203
  - Unicode and ASCII and, 62–63
- charAt** (index) method
  - retrieving characters in strings, 339–340
  - StringBuilder** class, 355–356
- charValue** method, **Character** class, 350
- Check boxes
  - creating, 311
  - events, 640–643
  - JCheckBox** class, 471–472
  - types of buttons, 468
- Checked exceptions, 525
- Choice lists. *see* Combo boxes
- Circle** class, 296–297
- Clarity, class design guidelines, 392
- Class abstraction, 375
- Class diagrams, UML, 297
- Class encapsulation, 375–376
- Class loaders, 22
- Class variables, 312
- ClassCastException**, 426
- Classes
  - abstract. *see* Abstract classes
  - abstraction and encapsulation in, 375–376
  - case study: designing class for stacks, 386–388
  - case study: designing **Course** class, 384–386
  - in **CircleWithPrivateDataFields.java** example, 320–321
  - in **CircleWithStaticMembers.java** example, 313–314
  - clients of, 299
  - commenting, 25
  - in **ComputeExpression.java**, 19
  - data field encapsulation for maintaining, 319–320
  - defining custom exception classes, 538–541
  - defining for objects, 296–298
  - design guidelines, 391–393
  - designing for reuse, 499
  - for displaying GUI components, 310–312
  - event classes, 603
  - event listeners. *see* Listener classes
  - identifiers, 40
  - inner (nested) classes. *see* Inner (nested) classes
  - from Java Library, 308
  - names/naming conventions, 17, 44
  - preventing extension of, 439–440
  - for primitive data types, 350
  - static variables, constants, and methods, 312–313
  - in **TestCircleWithPrivateDataFields.java** example, 321–322
  - in **TestCircleWithStaticMembers.java** example, 314–317
  - in UML diagram, 298
  - variable scope and, 371–372
  - visibility modifiers, 317–319
  - in **Welcome.java**, 17
  - in **WelcomeWithThreeMessages.java**, 18
- Classes, binary I/O
  - BufferedInputStream** and **BufferedOutputStream** classes, 719–722
  - DataInputStream** and **DataOutputStream** classes, 716–718
  - DetectEndOfFile.java**, 719
  - FileInputStream** and **FileOutputStream** classes, 713–714
  - FilterInputStream** and **FilterOutputStream** classes, 716
  - overview of, 712–713
  - TestDataStream.java**, 718–719
  - TestFileStream.java**, 714–716
- Class's contract, 375
- Clock speed, CPUs, 3
- clone** method, shallow and deep copies, 579–580
- Cloneable** interface
  - House.java** example, 578–581
  - overview, 577–578
- Closest pair problem, two-dimensional array applied to, 272–273
- COBOL, high-level languages, 11
- Code
  - arrays for simplifying, 229
  - comments and, 109
  - programming. *see* Programs/programming
  - reuse. *see* Reusable code
  - sharing. *see* Sharing code
- Codebase** attribute, applets, 674
- Coding (Implementation)
  - incremental development, 137
  - in software development process, 60–61
- Coherent purpose, class design guidelines, 391
- Color
  - Component** class and, 499
  - setting background and foreground color, 463
- Color** class
  - helper classes, 446, 448
  - in Java GUI API, 460–462

- Combo boxes
  - [ComboBoxDemo.java](#), 648–649
  - creating, 310–312
  - overview of, 647–648
- Command-line arguments, 358–361
- Comments
  - code maintainability and, 109
  - programming style and, 25
  - in [Welcome.java](#), 17
- Common denominator, finding greatest common denominator.
  - see* [Gcd](#) (greatest common denominator)
- Communication devices, computers and, 8–9
- Compact discs (CDs), as storage device, 6
- Comparable** interface
  - [ComparableRectangle.java](#) example, 575–576
  - overview of, 573–574
  - [Rational](#) class implementing, 585
  - [SortComparableObjects.java](#) example, 574–575
  - [SortRectangles.java](#) example, 576–577
- compareTo** method
  - [Character](#) class, 350–351
  - [Cloneable](#) interface and, 577
  - [Comparable](#) interface defining, 573–574
  - [ComparableRectangle.java](#) example, 575–576
  - comparing strings, 338
  - implementing in [Rational](#) class, 588
  - wrapper classes and, 394
- compareToIgnoreCase** method, strings, 338–339
- Comparing strings, 337–339
- Comparison operator (**==**), 82, 430
- Compile errors (Syntax errors)
  - common errors, 18
  - debugging, 119–120
  - programming errors, 26–27
- Compilers
  - ambiguous invocation and, 195
  - reporting syntax errors, 26
  - translating Java source file into bytecode file, 20–21
  - translating source program into machine code, 10–11
- Completeness, class design guidelines, 392
- Complex numbers, [Math](#) class, 594
- Component** class
  - as abstract class, 447
  - color and font methods, 499
  - common features of [Component](#), [Container](#), and [JComponent](#), 462
  - subclasses of, 446, 451
- Components
  - adding to [BorderLayout](#) to, 456
  - adding to frames, 450–451
  - combo boxes, 647–648
  - [ComboBoxDemo.java](#), 648–649
  - common features of, 462
  - comparing Swing and AWT components, 446
  - component classes, 446–447
  - [DescriptionPanel.java](#), 645–646
  - events, 640
  - [GUIEventDemo.java](#), 640–643
  - [Histogram.java](#), 662–664
  - [JComponent](#) class. *see* [JComponent](#) class
  - [JFrame](#) displaying, 449
  - [JTextComponent](#) class, 474–475
  - [ListDemo.java](#), 652–654
  - lists, 649–652
  - multiple windows, 660–661
  - [MultipleWindowsDemo.java](#), 661–662
  - naming conventions, 468
  - overview of, 639–640
  - questions and exercises, 664–670
  - scroll bars, 654–655
  - [ScrollBarDemo.java](#), 655–657
  - [SliderDemo.java](#), 658–660
  - sliders, 657–658
  - summary, 664
  - text areas, 644–645
  - [TextAreaDemo.java](#), 646–647
- Composition relationships
  - between [ArrayList](#) and [MyStack](#), 436–437
  - objects and, 382–383
- Compute expression, 19
- Computers
  - communication devices, 8–9
  - CPUs, 3–4
  - input/output devices, 7–8
  - memory, 4–5
  - OSs (operating systems), 12–13
  - overview of, 2–3
  - programming languages, 9–12
  - storage devices, 5–7
- concat method**, 340
- Concatenate strings, 36, 68, 340
- Conditional AND operator, 104
- Conditional expressions, 111–112
- Confirmation dialogs
  - controlling loops, 164–165
  - making selections, 117–119
- Connect four game, 288
- Consistency, class design guidelines, 391
- Consoles
  - defined, 16
  - formatting output, 112–115
  - input, 16
  - output, 16
  - reading input, 37–40
- Constants
  - accessing in interfaces, 572
  - class, 312–313
  - declaring, 313
  - in [FigurePanel.java](#), 486
  - identifiers, 40
  - key constants, 622
  - named constants, 43
  - naming conventions, 44
  - wrapper classes and, 394

- Constructor chaining, 415–417
- Constructors
  - in abstract classes, 562
  - for **BMI** class, 381
  - calling subclass constructors, 414–415
  - for **Character** class, 350
  - creating objects with, 303
  - creating **Random** objects, 310
  - for **DataInputStream** and **DataOutputStream** classes, 717
  - for **Date** class, 309
  - for **GuessDate** class, 390–391
  - in **ImageViewer.java** example, 507
  - interfaces vs. abstract classes, 581
  - invoking with **this** reference, 374–375
  - for **Loan** class, 377–379
  - object methods and, 296–297
  - private**, 319
  - in **SimpleCircle** example, 299–300
  - for **String** class, 336
  - for **StringBuilder** class, 353
  - in **TV.java** example, 300
  - UML diagram of, 298
  - wrapper classes and, 393
- Containers/ **Container** class
  - common features in **Component**, **Container**, and **JComponent** classes, 462
  - JPanel** as subclass of, 459–460
  - overview of, 446, 447–448
- Content pane, in **JFrame** class, 450–451
- Content-pane delegation, 451
- continue** statements, for controlling loops, 159–162
- Contract, object class as, 296
- Control units, CPUs, 3
- Control variables, in **for** loops, 147–148
- Conversion methods, for wrapper classes, 394
- Converting strings
  - to/from arrays, 343–344
  - to/from numeric values, 344
  - overview of, 341
- Coordinates
  - drawing polygons, 490–491
  - Java coordinate system, 481
  - in **MessagePanel** class, 499
- Copying
  - arrays, 236–237
  - files, 722–723
- Core, of CPU, 4
- cos method, trigonometry, 197–198
- Cosine function, 511
- Counter-controlled loops, 135
- Coupon collector's problem, 260
- Course** class, 384–386
- CPUs (central processing units), 3–4
- Curly braces ({} )
  - in block syntax, 17–18
  - dangers of omitting, 85
  - forgetting to use, 93
- currentTimeMillis** method, 51–52
- Cursor, mouse, 8
- Cursor** class, 463
- D**
- .dat files (binary), 712
- Data, arrays for referencing, 224
- Data fields
  - accessing object data, 304–305
  - encapsulating, 319–320, 391–392
  - in interfaces, 572
  - object state represented by, 296–297
  - referencing, 305, 373–374
  - in **SimpleCircle** example, 299–300
  - in **TV.java** example, 301
  - UML diagram of, 298
- Data streams. *see* **DataInputStream/DataOutputStream** classes
- Data types
  - ADT (abstract data type), 375
  - boolean**, 82–84, 309–310
  - characters. *see* Characters/ character data type (**char**)
  - double**. *see* **double** (double precision) data type
  - float**. *see* Floating-point numbers/float data type
  - fundamental. *see* Primitive types
  - integers. *see* Integers (**int** data type)
  - long** data type. *see* **long** data type
  - numeric, 44–46, 56–58
  - reference types. *see* Reference types
  - specifying, 35
  - strings, 68–69
  - types of, 41
  - using abstract class as, 564
- DataInputStream/DataOutputStream** classes
  - DetectEndOfFile.java**, 719
  - overview of, 716–718
  - TestDataStream.java**, 718–719
- Date** class
  - case study: **Calendar** and **GregorianCalendar** classes, 567–568
  - java.util**, 308–309
- De Morgan's law, 104
- Debugging
  - benefits of stepwise refinement, 210
  - code modularization and, 189
  - selections, 119–120
- Decimal numbers
  - BigDecimal** class, 397–398
  - converting to hexadecimals, 191–193, 348–350, 763
  - converting to/from binary, 364, 763
  - division of, 51
- Declaring constants, 43, 313
- Declaring exceptions
  - CircleWithException.java** example, 531
  - ReadData.java** example, 546
  - TestCircleWithCustomException.java** example, 539
  - throws** keyword for, 526

## 792 Index

- Declaring static methods, 313
  - Declaring variables
    - array variables, 225
    - overview of, 41
    - specifying data types and, 35–36
    - two-dimensional array variables, 264–265
  - Decrement (`--`) operator, 54–56
  - Deep copies, 579–580
  - Default field values, for data fields, 305–306
  - Delete key, on keyboards, 8
  - Delimiters, token reading methods and, 546–547
  - Denominator. *see* Gcd (greatest common denominator)
  - Denominators, in rational numbers, 584
  - Deployment, in software development process, 59
  - Descent, in text fonts, 493
  - DescriptionPanel** class, 645–647
  - Descriptive names
    - benefits of, 40
    - for variables, 35
  - Deserialization, of objects, 727
  - Design guidelines, classes, 391–393
  - destroy** method, applet life-cycle, 677–678
  - Dialog boxes
    - confirmation dialogs, 117–119, 164–165
    - Dialog** class, 447
    - displaying file dialogs, 549–550
    - input dialogs, 70, 72
    - JDialog** class, 447–448
    - message dialogs, 22–23
  - Dialog** class, 447
  - Dial-up modems, 8
  - Digital subscriber lines (DSLs), 8
  - Digital versatile disc (DVDs), 6
  - Digits, matching, 107
  - Dimension** class, 448
  - Direct recursion, 741
  - Directories
    - case study: determining directory size, 749
    - DirectorySize.java**, 749–750
    - File** class and, 542
    - file paths, 541
  - Disks, as storage device, 6
  - Display message
    - in dialog box, 22–24
    - in **Welcome.java**, 17
    - in **WelcomeWithThreeMessages.java**, 18
  - Divide-and-conquer strategy. *see* Stepwise refinement
  - Division (`/=`) assignment operator, 53–54
  - Division operator (`/`), 46, 50
  - Documentation, programming and, 24
  - Dot operator (`.`), 23, 304
  - Dot pitch, measuring sharpness of displays, 8
  - double** (double precision) data type
    - converting characters and numeric values to strings, 344
    - converting strings to numbers, 70
    - declaring variables and, 41
    - java.util.Random**, 309–310
    - overview of numeric types, 45
    - precision of, 154–155
  - do-while** loops
    - deciding when to use, 150–151
    - overview of, 144–146
  - Downcasting objects, 425
  - drawArc** method, 488–490
  - drawImage** method, 504–505
  - drawLine** method, 483
  - drawOval** method, 484, 488
  - drawPolygon** method, 491
  - drawPolyline** method, 491
  - drawRect** method, 483–484
  - drawString** method, 483
  - Drives, 6
  - Drop-down lists. *see* Combo boxes
  - DSLs (digital subscriber lines), 8
  - DVDs (Digital versatile disc), 6
  - Dynamic binding, inheritance and, 422–425
- ## E
- Eclipse
    - built in debugging, 119
    - creating/editing Java source code, 19
    - stopping programs with Terminate button, 450
  - Eight Queens puzzle, 259, 262, 765–766
  - Element type, specifying for arrays, 225
  - Emirp, 218
  - Encapsulation
    - in **CircleWithPrivateDataFields.java** example, 320–321
    - class design guidelines, 391
    - of classes, 375–376
    - of data fields, 319–320
    - in **GuessDate** class, 391
    - information hiding with, 203
    - of **Rational** class, 589
    - strings and, 339
  - Encoding schemes
    - defined, 4
    - mapping characters to binary equivalents, 61
  - End of file exception (**EOFException**), 719
  - endIndex** method, for obtaining substrings from strings, 341
  - End-of-line style, block styles, 25–26
  - Equal (`=`) operator, for assignment, 82
  - Equal (`==`) operator, for comparison, 82
  - equalArea** method, for comparing areas of geometric objects, 563
  - equals** method
    - Arrays** class, 253
    - Character** class, 350–351
    - comparing strings, 337
    - Object** class, 429–430
  - equalsIgnoreCase** method, comparing strings, 338–339
  - Error** class, 524, 526
  - Errors, programming. *see* Programming errors
  - Escape characters (`\`), 63–64

- Event delegation, 603
  - Event handlers/event handling, 601–602
    - anonymous class listeners, 611
    - [DetectSourceDemo.java](#), 613–614
    - [ListDemo.java](#), 653
    - overview of, 604
  - Event listener object, 603
  - Event listeners, 603–604. *see also* Listener classes
  - Event source object, 602–603
  - Event-driven programming
    - alternatives for defining listener classes, 612
    - animation using [Timer](#) class, 625–626
    - [AnimationDemo.java](#), 626–628
    - anonymous class listeners, 609–610
    - [AnonymousListenerDemo.java](#), 610–612
    - case study: loan calculator, 615
    - [ClockAnimation.java](#), 628–629
    - [ControlCircle.java](#), 607–608
    - [ControlCircleWithMouseAndKey.java](#), 623–625
    - [ControlCircleWithoutEventHandling.java](#), 606–607
    - defined, 602
    - [DetectSourceDemo.java](#), 612–613
    - event handlers, 604
    - event listeners, 603–604
    - events and event sources, 602–603
    - [FrameAsListenerDemo.java](#), 613–614
    - [HandleEvent.java](#), 601–602
    - inner classes, 608–609
    - key events, 621–622
    - key terms, 629
    - [KeyEventDemo.java](#), 622–623
    - listener interface adapters, 620–621
    - [LoanCalculator.java](#), 615–617
    - mouse events, 617–618
    - [MoveMessageDemo.java](#), 618–620
    - overview of, 600–601
    - questions and exercises, 630–638
    - register listeners, 604–605
    - summary, 629–630
  - Event-listener interface, 603
  - [EventObject](#) class, [java.util](#), 602–603, 605
  - Events
    - [ControlCircleWithMouseAndKey.java](#), 623–625
    - event sources and, 602–603
    - GUI component, 640
    - [GUIEventDemo.java](#), 640–643
    - [JList](#) class, 651
    - key events, 621–622
    - [KeyEventDemo.java](#), 622–623
    - mouse events, 617–618
    - [MoveMessageDemo.java](#), 618–620
    - [Timer](#) class firing [ActionEvents](#), 625–626
  - Exception** class
    - exceptions in, 524
    - extending, 538
    - in [java.lang](#), 539
    - subclasses of, 524–525
  - Exception handling. *see also* Programming errors
    - catching exceptions, 527–529, 531
    - chained exceptions, 537–538
    - [CircleWithException.java](#) example, 531–532
    - declaring exceptions ([throws](#)), 526, 531
    - defining custom exception classes, 538–541
    - [finally](#) clause in, 534–535
    - getting information about exceptions, 529–530
    - [InputMismatchExceptionDemo.java](#) example, 522–523
    - key terms, 552
    - overview of, 39, 517–518
    - questions and exercises, 554–558
    - [Quotient.java](#) example, 518
    - [QuotientWithException.java](#) example, 520–522
    - [QuotientWithIf.java](#) example, 519
    - [QuotientWithMethod.java](#) example, 519–520
    - rethrowing exceptions, 536–537
    - summary, 553–554
    - [TestCircleWithException.java](#) example, 532–534
    - [TestException.java](#) example, 530
    - throwing exceptions, 526–527, 531
    - types of exceptions, 523–525
    - when to use exceptions, 535–536
  - Exception propagation, 527
  - Exceptions. *see also* Programming errors
    - catching ([try-catch](#)), 527–529
    - checked and unchecked, 525
    - [ClassCastException](#), 426
    - declaring, 526
    - defined, 518
    - [EOFException](#), 719
    - in [Exception](#) class, 524
    - [FileNotFoundException](#), 713
    - handling. *see* Exception handling
    - in [House.java](#) example, 579
    - [IOException](#), 713–714
    - [NotSerializableException](#), 727
    - throwing, 526–527
  - Exclusive or ([^](#)) logical operator, 102–105
  - Execution stacks. *see* Call stacks
  - [exists](#) method, for checking file instances, 542–543
  - Explicit casting, 56–57, 425
  - Exponent method, [Math](#) class, 198–199
  - Exponent operations, 48
  - Expressions
    - assignment statements and, 42
    - behind the scene evaluation, 116
    - Boolean. *see* Boolean expressions
    - evaluating, 50–51
  - [extends](#) keyword, interface inheritance and, 582
- ## F
- Factorials
    - case study: computing factorials, 738–739
    - [ComputeFactorial.java](#), 739–741
    - [ComputeFactorialTailRecursion.java](#), 759
    - tail recursion and, 758–759

## 794 Index

- Fahrenheit, converting Celsius to/from, 50–51, 213
  - Fall-through behavior, **switch** statements, 109
  - Feet, converting to/from meters, 213–214
  - fib** method, 742–744
  - Fibonacci, Leonardo, 742
  - Fibonacci numbers
    - case study: computing, 741–742
    - ComputeFibonacci.java**, 742–744
    - computing recursively, 761
  - FigurePanel** class
    - FigurePanel.java**, 486–488
    - overview of, 485
    - TestFigurePanel.java**, 485–486
  - File** class, 541–543, 710
  - File I/O. *see* I/O (input/output)
  - File pointers, random-access files and, 730
  - FileInputStream/FileOutputStream** classes
    - overview of, 713–714
    - TestFileStream.java**, 714–716
  - Files
    - case study: copying files, 722–723
    - case study: replacing text in, 548–549
    - displaying file dialogs, 549–550
    - File** class, 541–543, 710
    - input/output, 544
    - JFileChooser** class, 550
    - key terms, 552
    - questions and exercises, 554–558
    - reading data from, 545–547
    - reading data from Web, 551–552
    - summary, 553–554
    - TestFileClass.java**, 543–544
    - writing data to, 544–545
  - FilterInputStream/FilterOutputStream** classes, 716
  - final** keyword, for declaring constants, 43
  - final** modifier, for preventing classes from being extended, 439–440
  - finally** clause, in exception handling, 534–535
  - Floating-point literals, 49
  - Floating-point numbers/**float** data type
    - approximation of, 47
    - converting characters and numeric values to strings, 344
    - converting to integers, 56
    - java.util.Random**, 309–310
    - minimizing numeric errors related to loops, 154–155
    - numeric types for, 45
    - overview of numeric types, 45
    - specifying data types, 35
    - specifying precision, 114
  - Flowcharts
    - do-while** loops, 145
    - if** statements, 84–85
    - if-else** statements, 90
    - for** loops, 147
    - switch** statements, 108
    - while** loops, 135
  - FlowLayout** class
    - overview of, 452
    - properties of, 457
    - ShowFlowLayout.java** example, 452–454
  - Font** class
    - helper classes, 446, 448
    - in Java GUI API, 461–462
  - FontMetrics** class
    - centering a string using, 493–494
    - helper classes, 446, 448
    - TestCenterMessage.java** example, 494–495
  - Fonts
    - Component** class, 499
    - creating, 463
    - GUIEventDemo.java**, 642
    - setting for message panel, 495
  - for** loops
    - deciding when to use, 151
    - nesting, 152, 267
    - overview of, 146–149
    - processing arrays with, 227
    - variable scope and, 196
  - for-each** (enhanced) loops, 229–231
  - Foreground color, 463–464
  - Formal parameters. *see* Parameters
  - format** method, strings, 344–347
  - Format specifiers, 113–115
  - FORTRAN, high-level languages, 11
  - Fractals
    - case study, 754–755
    - H-tree fractals, 766
    - Koch snowflake fractal, 764
    - SierpinskiTriangle.java**, 755–757
  - Frames (windows)
    - adding components to, 450–451
    - creating, 310–312, 449, 457, 641, 676
    - DisplayLabel.java**, 677
    - Frame** class, 447
    - JFrame** class. *see* **JFrame** class
    - ListDemo.java**, 653
    - MultipleWindowsDemo.java**, 661–662
    - MyFrame.java** example, 449–450
    - ScrollbarDemo.java**, 656
    - SliderDemo.java**, 659
  - Free cells, in Sudoku grid, 274
  - Function keys, on keyboards, 7
  - Functions, 179. *see also* Methods
  - Fundamental types (Primitive types). *see* Primitive types
- ## G
- Galton box, 258–259
  - Garbage collection, JVM and, 236
  - GBs (gigabytes), of storage, 5
  - Gcd (greatest common denominator)
    - case study: finding greatest common denominator, 155–157
    - computing recursively, 760
    - gcd method**, 189–190
    - gcd** method, 588
    - Rational** class and, 585

- Gene sequences, 367
  - Genome, 367
  - GeometricObject** class
    - Circle.java** and **Rectangle.java**, 562
    - overview of, 560
    - TestGeometricObject.java**, 562–563
  - getAbsolutePath** method, **File** class, 542–543
  - getArea** method, **SimpleCircle** example, 299
  - getArray** method, 269–270
  - getBMI** method, **BMI** class, 381
  - getChars** method, converting strings into arrays, 343
  - getDateCreated** method, **Date** class, 370
  - getFontMetrics** method, **Graphics** class, 493–494
  - getHeight** method, **FontMetrics** class, 495
  - getIndex** method, **ArrayList** class, 433
  - getPerimeter** method, **SimpleCircle** example, 299
  - getRadius** method, **CircleWithPrivateDataFields.java** example, 321
  - getRandomLowerCaseLetter** method, 241, 243
  - getSize** method, finding directory size, 750
  - getSource** method, events, 602
  - getStackTrace** method, for getting information about exceptions, 529
  - getStatus** method, **BMI** class, 381
  - Getter (accessor) methods
    - ArrayList** class and, 434
    - encapsulation of data fields and, 320–322
  - getTime** method, **Date** class, 309
  - getWidth** method, **FontMetrics** class, 495
  - GIF (Graphics Interchange Format), 465
  - Gigabytes (GBs), of storage, 5
  - Gigahertz (GHz), clock speed, 4
  - GMT (Greenwich Mean Time), 51
  - Gosling, James, 13
  - Graphics
    - case study: **FigurePanel** class, 485–488
    - case study: **ImageViewer** class, 506–507
    - case study: **MessagePanel** class, 495–497
    - case study: **StillClock** class, 500
    - centering a string using **FontMetrics** class, 493–495
    - DisplayClock.java** example, 500–502
    - DisplayImage.java** example, 505
    - displaying images, 504–505
    - drawing arcs, 488–490
    - drawing polygons and polylines, 490–493
    - drawing strings, lines, rectangles, and ovals, 483–484
    - ImageViewer.java** example, 507–508
    - MessagePanel.java** example, 497–500
    - overview of, 479–480
    - questions and exercises, 509–516
    - SixFlags.java** example, 506–507
    - StillClock.java** example, 502–504
    - summary, 508–509
    - TestPaintComponent.java** example, 481–483
  - Graphics** class
    - getFontMetrics** method, 493
    - helper classes, 446, 448
    - overview of, 480–481
  - Graphics Interchange Format (GIF), 465
  - Greater than (>) comparison operator, 82
  - Greater than or equal to (>=) comparison operator, 82
  - Greatest common denominator. *see* Gcd (greatest common denominator)
  - Greenwich Mean Time (GMT), 51
  - GregorianCalendar** class
    - Cloneable** interface and, 577–578
    - in **java.util** package, 331
    - overview of, 567–568
    - TestCalendar.java**, 568–569
  - GridLayout** class
    - overview of, 454–455
    - properties of, 457
    - ShowGridLayout.java** example, 455–456
  - Grids
    - GridLayout** manager, 454–456
    - representing using two-dimensional array, 274
  - GuessDate** class, 388–391
  - GUI (graphical user interface)
    - alignment, 470
    - BorderLayout** class, 456–457
    - classes for GUI components, 310–312
    - Color** class, 460–462
    - common features of Swing GUI components, 462–465
    - Component** class, 447
    - components. *see* Components
    - Container** class, 447–448
    - converting GUI applications into applets, 672
    - FlowLayout** class, 452–454
    - Font** class, 461–462
    - frames, 449–451
    - GridLayout** class, 454–456
    - GUI objects created from classes, 296
    - helper classes, 448
    - icons, pressed icons, and rollover icons, 469
    - image icons, 465–467
    - Java GUI API, 446–447
    - JButton** class, 467–469
    - JCheckBox** class, 471–472
    - JLabel** class, 473–474
    - JRadioButton** class, 472–473
    - JTextField** class, 474–475
    - key terms, 475
    - layout managers, 451
    - overview of, 445–446
    - panels used as subcontainers, 458–460
    - properties of layout managers, 457–458
    - questions and exercises, 476–478
    - summary, 475–476
    - Swing vs. AWT, 446
    - text positions, 470–471
- ## H
- Hand-traces, for debugging, 119–120
  - Hangman game, 367, 512, 556, 636
  - Hard disks, as storage device, 6

Hardware, 2

Has-a relationships  
 in aggregation models, 382–383  
 composition and, 437

Heap, dynamic memory allocation and, 239

Height, in text fonts, 493

Helper classes, 448

Helper methods, recursive  
 overview of, 746  
[RecursivePalindrome.java](#), 746–747

Hertz (Hz), clock speed in, 3

Hex integer literals, 49

Hexadecimal numbers  
 converting to/from binary, 364, 763  
 converting to/from decimals, 191–193, 348–350, 763

Hexagons, drawing, 491–492

Hidden data fields, referencing, 373–374

High-level languages, 10–12

Hilbert curve, 766

Horizontal scroll bars, 655

Horizontal sliders, 657, 659

Horizontal text positioning, 470

HTML (Hypertext Markup Language)  
[<applet>](#) tag, 673  
 defining applet parameters, 679  
[DisplayLabel.html](#), 673–674  
[DisplayMessage.html](#), 679–680  
 scripting language for document layout, 14  
 viewing applets from Web browser, 674

H-trees  
 fractals, 766  
 recursive approach to, 738

Hz (Hertz), clock speed in, 3

## I

Icons. *see* Image icons

Identifiers, 40

IDEs (integrated development environments)  
 for creating/editing Java source code, 19–20  
 overview of, 16

IEEE (Institute of Electrical and Electronics Engineers), floating  
 point standard (IEEE 754), 45

**if** statements  
 common errors, 93–95  
 in computing body mass index, 97–99  
 in computing taxes, 99–101  
 conditional operator used with, 112  
 nesting, 91  
 overview of, 84–85  
[SimpleIfDemo.java](#) example, 85–86

**if-else** statements  
 conditional expressions and, 112  
 dangling else ambiguity, 94–95  
 multi-way, 91–93  
 overview of, 89–91  
 recursion and, 744

**IllegalArgumentException** class, 527

**Image** class, 504

Image icons  
[ComboBoxDemo.java](#), 649  
 creating and placing, 691–692  
 default icons, pressed icons, and rollover icons, 469  
 displaying images, 504  
 overview of **ImageIcon** class, 465–466  
[TestImageIcon.java](#) example, 466–467

Images  
 case study: **ImageViewer** class, 506–507  
[DisplayImage.java](#) example, 505  
 displaying, 504–505  
[ImageViewer.java](#) example, 507–508  
[SixFlags.java](#) example, 506–507

**ImageViewer** class  
[ImageViewer.java](#) example, 507–508  
 overview of, 506–507

Immutable  
[BigInteger](#) and [BigDecimal](#) classes, 397–398  
 class, 370  
 objects, 370–371  
[Rational](#) class, 589  
[String](#) object, 336–337  
 wrapper classes, 394

Implementation (coding), in software development process,  
 59–61

Implementation methods, 207–210

Implicit casting, 64, 425

Importing  
 importing package into program, 23–24  
[JFrame](#) package, 449  
 types of **import** statements, 24

Increment (**++**) operator, 54–56

**increment** method, in [Increment.java](#) example, 186–187

Incremental development  
 benefits of stepwise refinement, 210  
 coding incrementally, 137  
 testing and, 61

Indentation, programming style, 25

Indexed variables, 226–227

Indexes  
 accessing elements in arrays, 224, 226  
 finding characters/substrings in a string, 342–343  
 string index range, 340

**indexOf** method, 342–343

Indirect recursion, 741

Infinite loops, 136

Infinite recursion, 741

Information  
 getting information about exceptions, 529–530  
 hiding (encapsulation), 203

Inheritance  
[ArrayList](#) object, 430–431  
 calling subclass constructors, 414–415  
 calling superclass methods, 417  
 case study: custom stack class, 436–437



- casting objects and, 425–426
- CastingDemo.java** example, 426–429
- CircleFromGeometricObject.java** example, 410–412
- constructor chaining and, 415–417
- DistinctNumbers.java** example, 434–436
- dynamic binding and, 422–425
- equals** method of **Object** class, 429–430
- interface inheritance, 570–571, 582
- is-a relationships and, 437
- key terms, 440
- Object** class and, 420–421
- overriding methods and, 418–420
- overview of, 407–408
- preventing classes from being extended or overridden, 439–440
- protected** data and methods, 437–440
- questions and exercises, 442–444
- RectangleFromGeometricObject.java** example, 412–413
- SimpleGeometricObject.java** example, 409–410
- summary, 440–441
- superclasses and subclasses and, 408–409
- TestArrayList.java** example, 431–434
- TestCircleRectangle.java** example, 413–414
- using **super** keyword, 414
- init** method, applet life-cycle methods, 677–678
- Initializing variables
  - arrays, 227–228
  - declaring variables and, 41
  - LottoNumbers.java**, 232
  - multidimensional arrays, 265
  - two-dimensional arrays, 267
- Inner (nested) classes
  - AnimationDemo.java**, 627
  - anonymous, 609–610
  - AnonymousListenerDemo.java**, 610–612
  - for defining listener classes, 608–609
  - KeyEventDemo.java**, 622
  - MoveMessageDemo.java**, 619
  - TicTacToe.java**, 689
- Input. *see also* I/O (input/output)
  - reading from console, 37–40
  - redirecting using **while** loops, 143–144
  - runtime errors, 27
  - streams. *see* **InputStream** classes
- Input, process, output (IPO), 39–40
- Input dialog boxes
  - getting input via, 70–72
  - ShowInputDialog** method, 70, 72
- InputMismatchException** class, 522–523, 547
- Input/output devices, computers and, 7–8
- InputStream** classes
  - BufferedInputStream**, 719–722
  - case study: copying files, 723–724
  - DataInputStream**, 716–718
  - deserialization and, 727
  - DetectEndOfFile.java**, 719
  - FileInputStream**, 713–714
  - FilterInputStream**, 716
  - ObjectInputStream** class, 724–725
  - overview of, 712–713
  - TestDataStream.java**, 718–719
  - TestFileStream.java**, 714–716
  - TestObjectInputStream.java**, 726
- Insert key, on keyboards, 8
- Insertion sorts, arrays, 250–252
- Instance methods
  - accessing object data and methods, 305
  - in **CircleWithStaticMembers.java**, 314
  - class design guidelines, 392–393
  - invoking, 377, 380
  - when to use instance methods vs. static, 313–314
- Instance variables
  - accessing object data and methods, 305
  - class design guidelines, 392–393
  - static variables compared with, 312–313
  - in **TestCircleWithStaticMembers.java**, 314
  - when to use instance variables vs. static, 316
- Instances. *see also* Objects
  - checking file instantiation, 542
  - checking object instantiation, 296, 426
- Institute of Electrical and Electronics Engineers (IEEE), floating point standard (IEEE 754), 45
- Integer literals, 48–49
- Integers (**int** data type)
  - ArrayList** for, 435
  - BigInteger** class, 397–398
  - casting to/from **char** types, 63
  - converting characters and numeric values to strings, 344
  - converting strings to numbers, 70
  - declaring variables and, 41
  - division of, 46, 51, 518–522
  - finding larger between two, 179
  - floating-point numbers converted to, 56
  - java.util.Random**, 309–310
  - numeric types for, 44–45
  - specifying data types, 35
- Integrated development environments (IDEs)
  - for creating/editing Java source code, 19–20
  - overview of, 16
- Intelligent guesses, 137
- Interface adapters, listener classes, 620–621
- Interfaces
  - abstract classes compared with, 581–584
  - benefits of, 576
  - case study: **Rational** class, 584–585
  - Cloneable** interface, 577–578
  - Comparable** interface, 573–574
  - ComparableRectangle.java** example, 575–576
  - for defining common class behaviors, 560
  - House.java** example, 578–581
  - key terms, 590
  - overview of, 570
  - questions and exercises, 590–598

Interfaces (*continued*)

- SortComparableObjects.java** example, 574–575
  - SortRectangles.java** example, 576–577
    - summary, 590
  - TestEdible.java** example, 570–573
- Interned strings, 336–337
- Interpreters, translating source program into machine code, 10–11
- Invoking methods, 180–182, 305
- I/O (input/output)
- binary I/O classes, 712–713
  - BufferedInputStream** and **BufferedOutputStream**
    - classes, 719–722
  - case study: copying files, 722–723
  - case study: replacing text, 548–549
  - Copy.java**, 723–724
  - DataInputStream** and **DataOutputStream** classes, 716–718
  - DetectEndOfFile.java**, 719
  - displaying file dialogs, 549–550
  - FileInputStream** and **FileOutputStream** classes, 713–714
  - FilterInputStream** and **FilterOutputStream** classes, 716
  - handling text I/O in Java, 710–711
  - key terms, 732
  - object I/O, 724–725
  - overview of, 544, 709–710
  - questions and exercises, 733–736
  - random-access files, 729–731
  - reading data from file using **Scanner** class, 545–547
  - reading data from Web, 551–552
  - serializable** interface, 727–728
  - serializing arrays, 728–729
  - summary, 733
  - TestDataStream.java**, 718–719
  - TestFileStream.java**, 714–716
  - TestObjectInputStream.java**, 726
  - TestObjectOutputStream.java**, 725–726
  - TestRandomAccessFile.java**, 731–732
  - text I/O vs. binary I/O, 711–712
  - types of I/O devices, 7–8
  - writing data to file using **PrintWriter** class, 544–545
- IOException**, 713–714
- IPO (input, process, output), 39–40
- Is-a relationships
- design guide for when to use interfaces vs. classes, 582
  - inheritance and, 437
- isAbsolute** method, **File** class, 542–543
  - isDigit** method, **Character** class, 351, 356–357
  - isDirectory** method, **File** class, 542–543
  - isFile** method, **File** class, 542–543
  - isHidden** method, **File** class, 542–543
- Is-kind-of relationships, 582
- isLetter** method, **Character** class, 351, 356–357
  - isLowerCase** method, **Character** class, 351
  - isPalindrome** method
    - RecursivePalindrome.java**, 746–747
    - as tail-recursive method, 758
  - isPrime** method, prime numbers, 191
  - isUpperCase** method, **Character** class, 351

**isValid** method, applying to grid, 276

**ItemEvents**

- GUI components firing, 640
- JComboBox** class, 647, 650

## Iterations

- loops and, 134
- recursion compared with, 757–758

**J****JApplet** class

- container classes, 446, 448
- developing applets, 672
- JFrame** class compared with, 676–677
- top-level containers, 447

**java** command, for executing Java program, 21

Java Development Toolkit (JDK)

- jdb debugger in, 119
- overview of, 16

Java EE (Java Enterprise Edition), 16

Java GUI API, 446–447

Java language specification, 16

Java Library, 308

Java ME (Java Micro Edition), 16

Java programming

- creating, compiling, and executing programs, 19–22
- displaying text in message dialog box, 22–24
- high-level languages, 11
- introduction to, 13–15
- simple examples, 16–19

Java SE (Java Standard Edition), 16

Java Virtual Machine. *see* JVM (Java Virtual Machine)

**java.awt** classes. *see* AWT (Abstract Windows Toolkit)

**javac** command, for compiling Java program, 21

Javadoc comments (`/**.*/`), 25

**java.io**

- File** class, 541–543
- PrintWriter** class, 544–545
- RandomAccessFile** class, 730

**java.lang**

- Class** class, 692
- Comparable** interface, 573
- Exception** class, 539
- Number** class, 565
- packages, 61
- Throwable** class, 523–525, 529–530

**java.net**

- MalformedURLException** class, 551
- URL** class, 551, 691–692

**java.util**

- Arrays** class, 252–253
- Calendar** class, 567–568
- Date** class, 308–309, 567
- EventObject** class, 602–603, 605
- GregorianCalendar** class, 331, 567–568
- Random** class, 309–310
- Scanner** class, 38, 545–547

- javax.swing.** *see* Swing
  - JButton** class
    - alignment, 470
    - creating buttons, 310–312, 451
    - creating push button, 467–469
    - default icons, pressed icons, and rollover icons, 469
    - image icons displayed as buttons, 466
    - inheriting from **Container** class, 460
    - text positions, 470–471
  - JCheckBox** class
    - creating check boxes, 311
    - events, 640–643
    - overview of, 471–472
    - types of buttons, 468
  - JComboBox** class
    - ComboBoxDemo.java**, 648–649
    - creating combo boxes, 310–312
    - GUI components, 647–648
  - JComponent** class
    - as abstract class, 447
    - common features in **Component**, **Container**, and **JComponent** classes, 462–463
    - overview of, 446–447
    - paintComponent** method, 480
    - subclassing, 483
  - jdb debugger, 119
  - JDialog** class, 447, 448
  - JDK (Java Development Toolkit)
    - jdb debugger in, 119
    - overview of, 16
  - JFileChooser** class, 550
  - JFrame** class
    - adding components to frames, 450–451
    - as container class, 446, 447–448
    - creating frames, 310–312, 449, 641, 676
    - JApplet** class compared with, 676
    - ShowFlowLayout** class extending, 452–454
  - JLabel** class
    - adding labels to frames, 452
    - adding labels to grids, 455
    - creating and placing image icons on, 691
    - creating labels, 311
    - image icons displayed as labels, 466
    - overview of, 473–474
  - JList** class
    - creating lists, 310–312
    - ListDemo.java**, 652–654
    - overview of lists, 650–652
  - Joint Photographic Experts Group (JPEG), 465
  - JOptionPane** class
    - as predefined Java class, 22
    - showConfirmDialog** method, 117–119
    - showInputDialog** method, 70, 72
  - JPanel** class
    - Ball** subclass, 683–684
    - Cell** subclass, 687–688
    - as container class, 446, 448
    - DescriptionPanel** extending, 645–646
    - FigurePanel** class, 485
    - ImageViewer** class, 506–507
    - paintComponent** method, 480
    - panels used as subcontainers, 458–459
    - StillClock** class, 500
    - subclassing, 482
    - TestPanels.java** example, 459–460
  - JPEG (Joint Photographic Experts Group), 465
  - JRadioButton** class
    - creating radio buttons, 310–312
    - events, 640
    - overview of, 472–473
    - types of buttons, 468
  - JScrollbar** class
    - BallControl.java**, 685
    - controlling bouncing speed in bouncing ball case study, 683
    - overview of, 654–655
    - ScrollbarDemo.java**, 655–657
  - JScrollPane** class
    - DescriptionPanel.java**, 646
    - overview of, 644
    - scrolling lists, 644
  - JSlider** class
    - overview of, 657–658
    - SliderDemo.java**, 658–660
  - JTextArea** class
    - overview of, 644–645
    - TextAreaDemo.java**, 646–647
  - JTextComponent** class, 474–475
  - JTextField** class
    - adding text fields to frames, 452
    - adding text fields to grids, 455
    - creating text fields, 311
    - events, 640
    - overview of, 474–475
  - JVM (Java Virtual Machine)
    - defined, 21
    - detecting runtime errors, 518
    - garbage collection, 236
    - heap as storage area in, 239
    - interned string and, 337
- ## K
- KBs (kilobytes), 5
  - Key constants, 622
  - Keyboards, 7
  - KeyEvent**s
    - ControlCircleWithMouseAndKey.java**, 625
    - KeyEventDemo.java**, 622–623
    - overview of, 621–622
  - KeyListener** interface, 621
  - Keywords (reserved words)
    - syntax of, 426
    - in **Welcome.java**, 17

## 800 Index

Kilobytes (KBs), 5

Knight's Tour, 765

Koch snowflake fractal, 764

## L

Labels

adding to frames, 452

adding to grids, 455

creating, 311

[DescriptionPanel.java](#), 645–646

image icons displayed as, 466

[JLabel](#) class. *see* [JLabel](#) class

placing, 641

LANs (local area networks), 8–9, 645–646

[lastIndexOf](#) method, strings, 342–343

[lastModified](#) method, [File](#) class, 542–543

Latin square, 293–294

Layout managers

[BorderLayout](#), 456–457

[FlowLayout](#), 452–454

[GridLayout](#), 454–456

[LayoutManager](#) class, 448

overview of, 451

properties of, 457–458

Leading, in text fonts, 493

Length, strings, 339–340, 355–356

[length](#) method, [File](#) class, 542–543

Less than (<) comparison operator, 82

Less than or equal to (<=) comparison operator, 82

Letters, counting, 352–353

Libraries, APIs as, 16

Life-cycle methods, applets, 677–678

Line comments, in [Welcome.java](#), 17

Line numbers, in [Welcome.java](#), 17

Linear searches, arrays, 245–246

Lines, drawing, 483–484, 487

Linux OS, 12

Listener classes

[ActionListener](#) interface, 600–602

adjustment listeners, 656

alternatives for defining, 612

[AnimationDemo.java](#), 627

anonymous listeners for defining, 609–610

[AnonymousListenerDemo.java](#), 610–612

[BallControl.java](#), 686

[ButtonListener](#) class, 617

case study: national flags and anthems, 696

[ClockAnimation.java](#), 628

[ComboBoxDemo.java](#), 650

[ControlCircle.java](#), 607–608

[ControlCircleWithoutEventHandling.java](#), 606–607

[DetectSourceDemo.java](#), 612–613

event listeners, 603–604

[FrameAsListenerDemo.java](#), 613–614

[HandleEvent.java](#), 601–602

inner classes for defining, 608–609

interface adapters, 620–621, 651–652

register listeners, 604–605

[SliderDemo.java](#), 659

[TicTacToe.java](#), 690

Listener interface adapters

[KeyEvents](#), 621

[ListSelectionListener](#) interface, 651–652

[MouseEvents](#), 620–621

Lists

creating, 310–312

[ListDemo.java](#), 652–654

overview of [JList](#) class, 650–652

[ListSelectionListener](#) interface, 651–652

Literals

Boolean literals, 83

character literals, 61

constructing strings from string literal, 336

defined, 48

floating-point literals, 49

integer literals, 48–49

LiveLab grading system, 15

Loans

interest rates in loan computation example, 71–72

Loan calculator case study, in event-driven programming, 615–617

[Loan.java](#) object, 377–379

Local area networks (LANs), 8–9, 645–646

Local variables, 196

Locker puzzle, 260

Logic errors (bugs), 27–28, 119–120

Logical operators (Boolean operators)

overview of, 101–102

[TestBooleanOperators.java](#) example, 103–105

truth tables, 102–103

**long** data type

converting characters and numeric values to strings, 344

integer literals and, 49

[java.util.Random](#), 309–310

overview of numeric types, 45

Loop body, 134

Loop-continuation-condition

**do-while** loop, 144–145

loop design and, 139

in multiple subtraction quiz, 140

overview of, 134–135

Loops

**break** and **continue** keywords as controls in, 159–162

case study: displaying prime numbers, 162–164

case study: finding greatest common denominator, 155–157

case study: guessing numbers, 137–139

case study: Monte Carlo simulation, 158–159

case study: multiple subtraction quiz, 139–141

case study: predicting future tuition, 157

controlling with confirmation dialog, 164–165

creating arrays, 237

deciding which to use, 150–151

design strategies, 139

- do-while** loop, 144–146
- input and output redirections, 143–144
- iteration compared with recursion, 757–758
- key terms, 165
- for** loop, 146–149
- minimizing numeric errors related to, 154–155
- nesting, 152–153
- overview of, 133–134
- questions and exercises, 166–175
- sentinel-controlled, 141–143
- summary, 166
- while** loop, 133–137
- Low-level languages, 10
  
- M**
- Mac OS, 12
- Machine language
  - bytecode compared with, 21
  - overview of, 9–10
  - translating source program into, 10–11
- Machine stacks. *see* Call stacks
- Main class
  - defined, 297
  - in **TestSimpleCircle.java** example, 298
- main** method
  - in **ComputeExpression.java**, 19
  - invoking, 181
  - main class vs., 297
  - receiving string arguments from command line, 358–359
  - in **SimpleCircle.java** example, 300–301
  - in **TestSimpleCircle.java** example, 298
  - in **TestTV.java** example, 300–301
  - in **Welcome.java**, 17
  - in **WelcomeWithThreeMessages.java**, 18
- Main windows, 660
- Maintenance, in software development process, 59
- MalformedURLException** class, 552
- Mandelbrot fractal, 595–597
- Marker interfaces, 577
- Markov matrix, 290
- Match braces, in **Welcome.java**, 17
- matches** method, strings, 342
- Math** class
  - BigInteger** and **BigDecimal** classes, 397–398
  - complex numbers, 594–595
  - exponent methods, 198–199
  - invoking object methods, 305
  - methods generally, 197
  - pow(a, b)** method, 48
  - random** method, 96–97, 106–108, 200–203
  - rounding methods, 199
  - service methods, 199–200
  - trigonometric methods, 197–198
- Matrices
  - GridLayout** manager for, 454
  - two-dimensional arrays for storing, 264–265
- max** method, **Math** class
  - defining and invoking, 180–182
  - overloading, 194–195
  - overview of, 199–200
- maxRow** variable, for finding largest sum, 268
- Mbps (million bits per second), 8
- MBs (megabytes), of storage, 5
- Megabytes (MBs), of storage, 5
- Megahertz (MHz), clock speed, 3
- Memory, computers, 4–5
- Mersenne prime, 218
- Message dialog boxes, 22–23
- MessagePanel** class
  - DisplayClock.java**, 500–502
  - MessagePanel.java**, 497–500
  - overview of, 495
  - StillClock.java**, 502–503
  - TestMessagePanel.java**, 495–496
- Meta objects, 692
- Meters, converting to/from feet, 213–214
- Method header, 179
- Method signature, 179
- Methods
  - abstraction, 203–204
  - accessing object methods, 304–305
  - calling, 180–182
  - case study: converting decimals to hexadecimals, 191–193
  - case study: generating random numbers, 201–203
  - class, 312–313
  - commenting, 25
  - defining, 178–180
  - identifiers, 40
  - implementation details, 207–210
  - invoking object methods, 305
  - key terms, 210
  - Math** class, 197, 199–201
  - modularizing code, 189–191
  - naming conventions, 44
  - object actions defined by, 296–297
  - overloading, 193–196
  - overview of, 177–178
  - passing arrays to, 237–240
  - passing objects to, 322–326
  - passing parameters by values, 186–189
  - passing to two-dimensional arrays, 269–270
  - questions and exercises, 211–222
  - recursive methods, 738
  - returning arrays from, 240–241
  - rounding, 199
  - in **SimpleCircle.java** example, 300–301
  - static, 313
  - stepwise refinement, 203–204, 210
  - summary, 211
  - top-down and/or bottom-up implementation, 205–207
  - top-down design, 204–205
  - tracing or stepping over as debugging technique, 119
  - trigonometric, 197–198

## 802 Index

### Methods (*continued*)

- variable scope and, 196–197
  - void** method example, 183–185
- MHz (Megahertz), clock speed, 3
- Microsoft Windows, 12
- MIDI files, 693
- Million bits per second (Mbps), 8
- min** method, **Math** class, 199–200
- Mnemonics
- in assembly language, 10
  - for check boxes and radio buttons, 641–643
- Modems (modulator/demodulator), 8
- Modifier keys, on keyboards, 8
- Modifiers, method, 179
- Modularizing code
- GreatestCommonDivisorMethod.java**, 189–190
  - overview of, 189
  - PrimeNumberMethod.java**, 190–191
- Monitors, 8
- Monte Carlo simulation, 158–159
- Motherboard, 3
- Mouse
- Cursor** class, 463
  - as I/O device, 8
- MouseEvent**s
- ControlCircleWithMouseAndKey.java**, 625
  - event-driven programming, 617–618
  - listener interface adapters, 620–621
  - MoveMessageDemo.java**, 618–620
- MouseListener** interface, 618, 627
- MouseMotionListener** interface, 619–620
- Multi-dimensional arrays. *see* Arrays, multi-dimensional
- Multimedia. *see* Applets
- Multiple choice test, 270–272
- Multiplication (**\*=**) assignment operator, 53–54
- Multiplication operator (**\***), 19, 46, 50
- Multiplication table, 152
- Multiplicities, in object composition, 382
- Multiprocessing, 13
- Multiprogramming, 13
- Multithreading, 13
- Multi-way **if-else** statements
- in computing taxes, 99–101
  - overview of, 91–93
- Mutator methods. *see* Setter (mutator) methods

## N

Named constants. *see* Constants

### Naming conventions

- class design guidelines, 391
- components, 468
- interfaces, 582
- programming and, 44
- wrapper classes, 393

Naming rules, identifiers, 40

*N*-by-*n* matrix, 215

Negative angles, drawing arcs, 490

### Nested **if** statements

- in computing body mass index, 97–99
- in computing taxes, 99–101
- overview of, 91

Nested loop, 152–153, 267

### NetBeans

- built in debugging, 119
- for creating/editing Java source code, 19
- stopping programs with Terminate button, 450

Network interface cards (NICs), 8

### **new** operator

- creating arrays, 225
- creating objects, 303

**next** method, whitespace characters and, 69

**nextLine** method, whitespace characters and, 69

Next-line style, block styles, 25

NICs (network interface cards), 8

### No-arg constructors

- class design guidelines, 391
- Loan** class, 377
- wrapper classes not having, 394

Not (!) logical operator, 102–105

Not equal to (!=) comparison operator, 82

**NotSerializableException**, 727

**null** values, objects, 305–306

**NullPointerException**, as runtime error, 306

### **Number** class

- case study: abstract number class, 564
  - as root class for numeric wrapper classes, 585
- Numbers/numeric types
- abstract number class, 565–567
  - binary. *see* Binary numbers
  - case study: converting hexadecimal to decimals, 348–350
  - case study: displaying prime numbers, 162–164
  - case study: generating random numbers, 201–203
  - case study: guessing numbers, 137–139
  - casting to/from **char** types, 63
  - conversion between numeric types, 56–58, 364
  - converting to/from strings, 70, 344
  - decimal. *see* Decimal numbers
  - double. *see* **double**
  - floating-point. *see* Floating-point numbers/**float** data type
  - generating random numbers, 96–97

**GreatestCommonDivisorMethod.java**, 189–190

hexadecimal. *see* Hexadecimal numbers

integers. *see* Integers (**int** data type)

**LargestNumbers.java**, 566–567

overview of, 44–46

**PrimeNumberMethod.java**, 190–191

processing large numbers, 397–398

Numerators, in rational numbers, 584

Numeric keypads, on keyboards, 8

Numeric literals, 48–49

### Numeric operators

- applied to characters, 64
- overview of, 46–47

## O

**Object** class, 420–421, 429–430

**Object I/O.** *see*

**ObjectInputStream/ObjectOutputStream** classes

Object member access operator (.), 304, 427

Object reference variables, 304

**ObjectInputStream/ObjectOutputStream** classes

overview of, 724–725

**serializable** interface, 727–728

Serializing arrays, 728–729

**TestObjectInputStream.java**, 726

**TestObjectOutputStream.java**, 725–726

Object-oriented programming (OOP), 296, 304, 379–382

Objects

accessing data and methods of, 304–305

accessing via reference variables, 304

array of, 326–327

**ArrayList** class, 430–431

arrays as, 239

**AudioClip** class, 693–694

automatic conversion between primitive types and wrapper class types, 396–397

**BigInteger** and **BigDecimal** classes, 397–398

cannot be created from abstract classes, 564

case study: designing class for stacks, 386–388

case study: designing **Course** class, 384–386

case study: designing **GuessDate** class, 388–391

casting, 425–426

**CircleWithPrivateDataFields.java** example, 320–321

**CircleWithStaticMembers.java** example, 313–314

class abstraction and encapsulation, 375–376

class design guidelines, 391–393

classes for displaying GUI components, 310–312

classes from Java Library, 308

comparing primitive variables with reference variables, 306–308

composing, 382–383

constructors, 303

creating, 298–299

data field encapsulation for maintaining classes, 319–320

**Date** class, 308–309

defining classes for, 296–298

**equals** method of **Object** class, 429–430

event listener object, 603

event objects, 602

immutable, 370–371

inheritance. *see* inheritance

key terms, 328–329, 399

**Loan.java**, 377–379

meta objects, 692

**null** values, 305–306

**Object** class, 420–421

object-oriented thinking, 379–382

overview of, 295–296, 369–370

passing to methods, 322–326

polymorphism, 421–422

processing primitive data type values as, 393–396

questions and exercises, 330–334, 399–406

**Random** class, 309–310

reference data fields and, 305

**SimpleCircle.java** example, 300–301

static variables, constants, and methods and, 312–313

summary, 329, 399

**TestCircleWithPrivateDataFields.java** example, 321–322

**TestCircleWithStaticMembers.java** example, 314–317

**TestLoanClass.java**, 376–377

**TestSimpleCircle.java** example, 298–300

**TestTV.java** example, 302–303

**this** reference and, 373–375

**TotalArea.java** example, 327–328

**TV.java** example, 301–302

variable scope and, 371–372

visibility modifiers, 317–319

Octal integer literals, 49

Off-by-one errors

arrays and, 230

in loops, 136

OOP (object-oriented programming), 296, 304, 379–382

Operands

defined, 46

incompatible, 104

Operators

assignment operator (=), 42–43

augmented assignment operators, 53–54

comparison operators, 82

increment and decrement operators, 54–56

numeric operators, 46–47

precedence and associativity, 115–117

precedence rules, 50–51

unary and binary, 47

Option panes

predefined Java classes, 22

**showConfirmDialog** method, 117–119

**showInputDialog** method, 70, 72

Or (||) logical operator, 102–105

OSs (operating systems)

overview of, 12

tasks of, 12–13

Output redirection, 143–144

Output streams, 710–711. *see also* I/O (input/output)

**OutputStream** classes

**BufferedOutputStream** classes, 719–722

case study: copying files, 723–724

**DataOutputStream** classes, 716–718

**DetectEndOfFile.java**, 719

**FileOutputStream** classes, 713–714

**FilterOutputStream** classes, 716

**ObjectOutputStream** class, 724–725

overview of, 712–713

serialization and, 727

**TestDataStream.java**, 718–719

**TestFileStream.java**, 715–716

**TestObjectOutputStream.java**, 725–726

## 804 Index

Ovals, drawing, 483–484, 487

Overflows

**Rational** class, 589  
variables, 45

Overloading methods, 193–196

Overriding methods, 418–420

## P

$\pi$  (pi), estimating, 158–159, 215

Package-private (package-access) visibility modifiers, 317

Packages

importing, 23–24  
importing **JFrame** package, 449  
organizing classes in, 318  
organizing programs in, 22  
predefined classes grouped into, 23

*Page Down* key, on keyboards, 8

*Page Up* key, on keyboards, 8

**paintComponent** method

**DisplayImage.java** example, 505  
drawing arcs and, 488–489  
**DrawPolygon.java** example, 492–493  
**JComponent** class, 480, 482  
**MessagePanel.java**, 494  
**StillClock.java**, 503  
**TestCenterMessage.java** example, 494

Palindromes

case study: checking if string is a palindrome, 347–348  
case study: ignoring nonalphanumeric characters when checking palindromes, 356–358  
palindrome integers, 212  
palindromic primes, 218  
**RecursivePalindrome.java**, 746–747  
**RecursivePalindromeUsingSubstring.java**, 745–746

Panels

adding, 489  
adding for **DisplayImage.java** example, 505  
check boxes and radio buttons for, 641  
creating, 311–312, 482  
**DescriptionPanel** class, 645–647  
**FigurePanel** class. *see* **FigurePanel** class  
**JPanel** class. *see* **JPanel** class  
**MessagePanel** class. *see* **MessagePanel** class  
as subcontainers, 458–460

**<param>** tag, applets, 679

Parameters

actual parameters, 179  
defining methods and, 178–179  
as local variable, 196  
order association, 186  
passing by values, 186–189  
variable-length argument lists, 244–245

Parentheses ( **( )** )

defining and invoking methods and, 203  
in **Welcome.java**, 18

Parsing methods, 395

Pascal, high-level languages, 11

Pass-by-sharing

arrays to methods, 238  
objects to methods, 323–324

Pass-by-value

arrays to methods, 238  
**Increment.java** example, 186–187  
objects to methods, 322–323  
overview of, 186  
**TestPassByValue.java** example, 187–189

Passwords, checking if string is valid password, 362

Pentagonal numbers, 212

Pixels (picture elements)

coordinates measure in, 481  
defined, 450  
measuring resolution in, 8

PNG (Portable Network Graphics), 465

**Point** class, 617–618

Polygons

drawing, 490–492  
**DrawPolygon.java**, 492–493

Polylines, drawing, 491

Polymorphism

**CastingDemo.java** example, 426–429  
overview of, 421  
**PolymorphismDemo.java** example, 421–422

Portable Network Graphics (PNG), 465

Postfix decrement operator, 54–55

Postfix increment operator, 54–55

**pow** method, **Math** class, 48

Precedence, operator, 115–117

Prefix decrement operator, 54–55

Prefix increment operator, 54–55

Pressed icons, 469

Prime numbers

case study: displaying prime numbers, 162–164  
**PrimeNumberMethod.java**, 190–191  
types of, 218

Primitive types (fundamental types)

automatic conversion between primitive types and wrapper class types, 396–397  
casting, 427  
classes for, 350  
comparing parameters of primitive type with parameters of reference types, 324  
comparing primitive variables with reference variables, 306–308  
converting wrapper object to/from (boxing/unboxing), 396  
creating arrays of, 326  
processing primitive data type values as objects, 393–396  
specifying data types, 35

**print** method, **PrintWriter** class, 38, 544–545

**printf** method, **PrintWriter** class, 544

Printing arrays, 267

**println** method, **PrintWriter** class, 38, 544

**printStackTrace** method, 529

**PrintWriter** class

case study: replacing text, 548–549



- writing data to file using, 544–545
  - for writing text data, 710
  - private**
    - encapsulation of data fields and, 319–320
    - visibility modifier, 318–319, 437–440
  - Problems
    - breaking into subproblems, 164
    - creating programs to address, 34
    - solving with recursion, 744–745
  - Procedural paradigm, compared with object-oriented paradigm, 381–382
  - Procedures, 179. *see also* Methods
  - Processing arrays, 227–229
  - Programming errors. *see also* Exceptions
    - ClassCastException**, 426
    - common class design errors, 393
    - debugging, 119–120
    - logic errors, 27–28
    - minimizing numeric errors related to loops, 154–155
    - runtime errors, 27
    - selections, 93–95
    - syntax errors, 18, 26–27
  - Programming languages
    - assembly language, 10
    - high-level languages, 10–12
    - Java. *see* Java programming
    - machine language, 9–10
    - overview of, 2
  - Programming style
    - block styles, 25–26
    - comments and, 25
    - indentation and spacing, 25
    - overview of, 24–25
  - Programs/programming
    - assignment statements and expressions, 42–43
    - augmented assignment operators, 53–54
    - case study: counting monetary units, 65–68
    - case study: displaying current time, 51–53
    - character data type, 62–65
    - coding incrementally, 137
    - evaluating expressions and operator precedence rules, 50–51
    - exponent operations, 48
    - identifiers, 40
    - increment and decrement operators, 54–56
    - input dialogs, 70–72
    - introduction to, 34
    - key terms, 72–73
    - modularizing code, 189–191
    - named constants, 43
    - naming conventions, 44
    - numeric literals, 48–49
    - numeric operators, 46–47
    - numeric type conversions, 56–58
    - numeric types, 44–46
    - overview of, 2
    - questions and exercises, 74–80
    - reading input from console, 37–40
    - recursive methods in, 738
    - software development process, 58–62
    - string** data type, 68–69
    - summary, 73–74
    - variables, 40–42
    - writing a simple program, 34–37
  - Properties
    - layout manager, 457–458
    - object, 296
  - Protected** data and methods, inheritance and, 437–440
  - protected** visibility modifier, 318, 437–440
  - Pseudocode, 34
  - Public classes, 299
  - public** method, 321
  - public** visibility modifier, 317–319, 437–440
  - Python, high-level languages, 11
- ## Q
- Quincunx, 258–259
  - Quotients
    - Quotient.java** example, 518
    - QuotientWithException.java** example, 520–522
    - QuotientWithIf.java** example, 519
    - QuotientWithMethod.java** example, 519–520
- ## R
- Radio buttons
    - creating, 310–312
    - events, 640
    - GUIEventDemo.java**, 640–643
    - JRadioButton** class. *see* **JRadioButton** class
    - overview of, 472–473
    - for panels, 641
    - types of buttons, 468
  - Ragged arrays, 266–267
  - RAM (random-access memory), 5–6
  - Random** class, **java.util**, 309–310
  - random** method
    - case study: generating random numbers, 201–203
    - case study: lottery, 106–108
    - Math** class, 96–97, 200–201
  - Random numbers
    - case study: generating random numbers, 201–203
    - case study: lottery, 106–108
    - case study: Monte Carlo simulation, 158–159
    - generating, 96–97
  - Random-access files
    - overview of, 729–731
    - TestRandomAccessFile.java**, 731–732
  - Random-access memory (RAM), 5–6
  - Rational** class
    - overview of, 584–585
    - Rational.java** example, 586–589
    - TestRationalClass.java** example, 585–586
  - Rational numbers, representing and processing, 584–586
  - readASolution** method, applying to Sudoku grid, 276

Read-only streams, 729. *see also* [InputStream](#) class

Rectangles, drawing, 483–484, 487

## Recursion

binary searches, 748–749

case study: computing factorials, 738–739

case study: computing Fibonacci numbers, 741–742

case study: determining directory size, 749

case study: fractals, 754–755

case study: Towers of Hanoi, 750–752

[ComputeFactorial.java](#), 739–741

[ComputeFactorialTailRecursion.java](#), 759

[ComputeFibonacci.java](#), 742–744

[DirectorySize.java](#), 749–750

helper methods, 746

iteration compared with, 757–758

key terms, 759

overview of, 737–738

problem solving by thinking recursively, 744–745

questions and exercises, 760–767

[RecursivePalindrome.java](#), 746–747

[RecursivePalindromeUsingSubstring.java](#), 745–746

[RecursiveSelectionSort.java](#), 747–748

selection sorts, 747

[SierpinskiTriangle.java](#), 755–757

summary, 759

tail recursion, 758

[TowersOfHanoi.java](#), 752–754

Recursive methods, 738

Reduction, characteristics of recursion, 744

## Reference types

classes as, 304

comparing parameters of primitive type with parameters of reference types, 324

comparing primitive variables with, 306–308

reference data fields, 305

[string](#) data type as, 68

## Reference variables

accessing objects with, 304

array of objects as array of, 326

comparing primitive variables with, 306–308

[regionMatches](#) method, strings, 338–339

## Register listeners

[ControlCircle.java](#), 607–608

[ControlCircleWithMouseAndKey.java](#), 624

[DetectSourceDemo.java](#), 613–614

[GUIEventDemo.java](#), 641–643

[KeyEventDemo.java](#), 623

[LoanCalculator.java](#), 616

overview of, 604–605

Regular expressions, matching strings with, 342

Relative file names, 541–542

Remainder (%) or modulo operator, 46, 50

Remainder (%) assignment operator, 53–54

## repaint method

applying to message panel, 497–498

[StillClock.java](#), 502–503

Repetition. *see* Loops

[replace](#) method, strings, 341

[replaceAll](#) method, strings, 342

[replaceFirst](#) method, strings, 341

Requirements specification, in software development process, 58–59

## Reserved words (keywords)

syntax of, 426

in [Welcome.java](#), 17

Resolution, pixels and, 450

Resource files, locating for applets using [URL](#) class, 691–692

Resources, role of OSs in allocating, 12

Responsibilities, separation as class design principle, 391

[return](#) statements, 181

## Return value type

constructors not having, 303

in defining methods, 179

## Reusable code

benefits of stepwise refinement, 210

code modularization and, 189

designing classes for, 499

method enabling, 182

methods for, 178

reverse method, returning arrays from methods, 240–241

RGB color model, 460

RMF files, 693

Rollover icons, 469

Rounding methods, [Math](#) class, 199

## Runtime errors

debugging, 119–120

declaring, 525–526

exception handling and, 39, 518

[NullPointerException](#) as, 306

programming errors, 27

Runtime stacks. *see* Call stacks

## S

Sandbox security model, 675

## Scanner class

obtaining input with, 72

for reading console input, 37–39

reading data from file using, 545–547

for reading text data, 710

## Scanners

case study: replacing text, 548–549

creating, 522

Scheduling operations, 13

Scientific notation, of integer literals, 49

Scope, of variables, 42, 196–197

Screen resolution, 8

## Scroll bars

[BallControl.java](#), 685

controlling bouncing speed in bouncing ball case study, 683

overview of, 654–655

[ScrollBarDemo.java](#), 655–657

- Scroll panes
  - [DescriptionPanel.java](#), 646
  - overview of, 644
  - scrolling lists, 651
- Searches
  - arrays, 245
  - binary searches, 246–248, 748–749
  - linear searches, 245–246
  - recursive approach to searching for words, 738
- Security restrictions, applets, 675–676
- Selection sorts
  - arrays, 245, 249–250
  - [RecursiveSelectionSort.java](#), 747–748
  - using recursion, 747
- Selection statements, 82, 84
- Selections
  - [Addition.Quiz.java](#) example, 83–84
  - boolean** data type, 82–84
  - case study: computing Body Mass Index, 97–99
  - case study: computing taxes, 99–101
  - case study: determining leap year, 105–106
  - case study: guessing birthdays, 86–89
  - case study: lottery, 106–108
  - common errors, 93–95
  - conditional expressions, 111–112
  - confirmation dialogs, 117–119
  - debugging, 119–120
  - formatting console output, 112–115
  - generating random numbers, 96–97
  - if** statements, 84–86
  - if-else** statements, 89–91
  - key terms, 120
  - logical operators, 101–105
  - nested **if** statements and multi-way **if-else** statements, 91–93
  - operator precedence and associativity, 115–117
  - overview of, 81–82
  - questions and exercises, 121–131
  - summary and exercises, 120–121
  - switch** statements, 108–111
- Semicolons (;), common errors, 93
- Sentinel-controlled loops, 141–143, 164–165
- Sequential files, input/output streams, 729
- Serialization
  - of arrays, 728–729
  - of objects, 727
- setBackground** method, **Component** class, 499
- setFont** method, **Component** class, 499
- setForeground** method, **Component** class, 499
- setLayout** method, **Component** class, 451
- setLength** method, **StringBuilder** class, 355–356
- setRadius** method
  - [CircleWithPrivateDataFields.java](#) example, 321
  - [SimpleCircle](#) example, 299
- Setter (mutator) methods
  - ArrayList** class and, 434
  - encapsulation of data fields and, 320–322
- Shallow copies, **clone** method and, 579–580
- Sharing code, 182
- short** numeric type, 45
- Short-circuited OR operator, 104
- showConfirmDialog** method, **JOptionPane** class, 117–119
- showInputDialog** method, **JOptionPane** class, 70, 72
- showMessageDialog** method, 22–23
- Shuffling arrays, 228–229, 268
- Sierpinski triangle
  - case study, 754–755
  - computing recursively, 762, 766–767
  - [SierpinskiTriangle.java](#), 755–757
- Signed applets, 676
- sin** method, trigonometry, 197–198
- Sine function, 511
- Single precision numbers. *see* Floating-point numbers/**Float** data type
- Single-dimensional arrays. *see* Arrays, single-dimensional
- Sinking sorts, 258
- Sliders
  - overview of, 657–658
  - [SliderDemo.java](#), 658–660
- Software
  - development process, 58–62
  - programs as, 2
- sort** method
  - Arrays** class, 252
  - [ComparableRectangle.java](#) example, 575–576
  - [SortRectangles.java](#) example, 576–577
  - using recursion, 747–748
- Sorting arrays
  - bubble sorts, 258
  - insertion sorts, 250–252
  - overview of, 248
  - selection sorts, 245, 249–250
- Source objects, event sources and, 602–603
- Source program or source code, 10, 40
- Spacing, programming style and, 25
- Special characters, 18
- Specific import, 24
- Splash screens, 467
- split** method, strings, 341, 342
- StackOfIntegers** class, 386–387
- StackOverflowError**, recursion causing, 757
- Stacks
  - case study: custom stack class, 436–437
  - case study: designing class for stacks, 386–388
- start** method, applet life-cycle methods, 677–678
- State, of objects, 296
- Statements
  - executing one at a time, 119
  - executing repeatedly (loops), 134
  - in high-level languages, 10
  - terminators, 17
- Static data, in **GuessDate** class, 388, 390

## Static methods

- in [CircleWithStaticMembers.java](#), 313–314
- class design guidelines, 392–393
- declaring, 313
- defined, 312
- in [GuessDate](#) class, 388–391
- invoking, 23
- when to use instance methods vs. static, 313–314
- wrapper classes and, 395

## Static variables

- in [CircleWithStaticMembers.java](#), 313–314
- class, 312–313
- class design guidelines, 392–393
- declaring, 313
- instance variables compared with, 312
- in [TestCircleWithStaticMembers.java](#), 314
- when to use instance variables vs. static, 316

## Stepwise refinement

- benefits of, 210
- implementation details, 207–210
- method abstraction, 203–204
- top-down and/or bottom-up implementation, 205–207
- top-down design, 204–205

**stop** method, applet life-cycle methods, 677–678

## Storage devices

- CDs and DVDs, 6
- disks, 6
- overview of, 5
- USB flash drives, 7

Storage units, for measuring memory, 4–5

**String** class, 336

String concatenation operator (+), 36, 340

String literals, 336

String variables, 336

**StringBuffer** class, 336, 353, 357

**StringBuilder** class

- case study: ignoring nonalphanumeric characters when checking palindromes, 356–358
- modifying strings in, 353–355
- overview of, 336, 353
- [toString](#), [capacity](#), [length](#), [setLength](#), and [charAt](#) methods, 355–356

## Strings

- in binary I/O, 716–717
- case study: checking if string is a palindrome, 347–348
- case study: converting hexadecimals to decimals, 348–350
- case study: ignoring nonalphanumeric characters when checking palindromes, 356–358
- Character** class, 350–351
- command-line arguments, 358–361
- comparing, 337–339
- concatenating, 36, 68
- constructing, 336
- converting, replacing, and splitting, 341
- converting to **double**, 71–72
- converting to/from arrays, 343–344
- converting to/from numbers, 70, 344

**CountEachLetter.java** example, 351–353

finding characters or substrings in, 342–343

formatting, 344–347

immutable and interned, 336–337

key terms, 361

matching, replacing, and splitting by patterns, 342

obtaining length, getting individual characters, and combining, 339–340

overview of, 335–336

passing to applets, 679

questions and exercises, 362–368

**string** data type, 68–69

**StringBuilder** and **StringBuffer** classes, 353–356

substrings, 37, 340–341

summary, 361–362

in [Welcome.java](#), 17

## Strings (graphics)

centering using [FontMetrics](#) class, 493–495

drawing, 483–484

## Subclasses

abstract methods and, 560

abstracting, 564

constructors, 414–415

creating graphics canvas, 482–483

of Exception class, 524–525

inheritance and, 408–409

of [RuntimeException](#) class, 525

Subcontainers, panels as, 458–460

Subdirectories, 749

Subinterfaces, 582

**substring** method, 340, 746

Substrings, 340–343

Subtraction (–) operator, 46, 50

Subtraction (–=) assignment operator, 53–54

Subwindows, 660

Sudoku puzzle, 274–277

**sum** method, 269–270

**super** keyword, 414

Superclass methods, 417

## Superclasses

of abstract class can be concrete, 564

classes extending, 581

common features in [Component](#), [Container](#), and [JComponent](#) classes, 462

[Container](#) class as, 460

inheritance and, 408–409

subclasses related to, 560

Supplementary characters, Unicode, 62

**swap** method

swapping elements in an array, 239–240

in [TestPassByValue.java](#) example, 187–189

## Swing

[AbstractButton](#) class, 468–469

applets. *see* [JApplet](#) class

AWT vs., 446

buttons. *see* [JButton](#) class

check boxes. *see* [JCheckBox](#) class

- combo boxes. *see* [JComboBox](#) class
  - common features of Swing GUI components, 462–465
  - components. *see* [JComponent](#) class
  - constants, 572–573
  - creating user interfaces with, 468
  - dialogs. *see* [JDialog](#) class
  - event classes in, 603
  - file choosers ([JFileChooser](#) class), 550, 551–552
  - frames. *see* [JFrame](#) class
  - labels. *see* [JLabel](#) class
  - lists. *see* [JList](#) class
  - option panes ([JOptionPane](#) class), 72
  - panels. *see* [JPanel](#) class
  - radio buttons. *see* [JRadioButton](#) class
  - scroll bars. *see* [JScrollBar](#) class
  - scroll panes, 644, 646
  - sliders ([JSlider](#) class), 657–660
  - text areas. *see* [JTextArea](#) class
  - text classes, 644
  - text components ([JTextComponent](#) class), 474–475
  - text fields. *see* [JTextField](#) class
  - switch** statements
    - [ChineseZodiac.java](#) example, 110–111
    - overview of, 108–110
  - Syntax errors (compile errors)
    - common errors, 18
    - debugging, 119–120
    - programming errors, 26–27
  - Syntax rules, in [Welcome.java](#), 18
  - System activities, role of OSs, 12
  - System analysis, in software development process, 58–59
  - System design, in software development process, 58, 60
  - System errors, 524
  - System resources, allocating, 12
  - [System.in](#), 37
  - [System.out](#), 37, 112–115
- T**
- Tables, storing, 264
  - Tags, HTML, 673–674
  - Tail recursion
    - [ComputeFactorialTailRecursion.java](#), 759
    - overview of, 758
  - tan [method](#), trigonometry, 197–198
  - TBs (terabytes), of storage, 5
  - Teamwork, facilitated by stepwise refinement, 210
  - Terabytes (TBs), of storage, 5
  - Testing
    - benefits of stepwise refinement, 210
    - in software development process, 59, 61–62
  - Text
    - case study: replacing text, 548–549
    - displaying in message dialog box, 22–24
    - files, 710
    - font attributes, 493
    - positioning with [JButton](#) class, 470–471
    - [.txt](#) files (text), 712
  - Text areas
    - [DescriptionPanel.java](#), 645–646
    - overview of, 644–645
    - [TextAreaDemo.java](#), 646–647
  - Text fields
    - adding to frames, 452
    - adding to grid, 455
    - creating, 311
    - events, 640
    - [JTextField](#) class, 474–475
    - panel for, 641
  - Text I/O
    - vs. binary I/O, 711–712
    - handling in Java, 710–711
    - overview of, 710
  - TextPad, for creating/editing Java source code, 19
  - this** reference
    - invoking constructors with, 374–375
    - overview of, 373–375
    - referencing hidden data fields with, 373–374
  - Three-dimensional arrays. *see* Arrays, multi-dimensional
  - throw** keyword
    - chained exceptions, 538
    - throw ex** for rethrowing exceptions, 537
    - for throwing exceptions, 527
  - Throwable** class
    - getting information about exceptions, 529–530
    - [java.lang](#), 523–525
  - Throwing exceptions
    - [CircleWithException.java](#) example, 531
    - [QuotientWithException.java](#) example, 521
    - rethrowing, 536–537
    - [TestCircleWithCustomException.java](#) example, 539
    - throw** keyword for, 526–527
  - throws** keyword
    - for declaring exceptions, 527
    - [IOException](#), 712–713
  - Tic-tac-toe game, 283
  - Timer** class
    - animation using, 625–626
    - [AnimationDemo.java](#), 626–628
    - [Ball.java](#), 684–685
    - [ClockAnimation.java](#), 628–629
  - toCharArray** method, converting strings into arrays, 343
  - Toggle buttons, 468
  - Token reading methods, [Scanner](#) class, 546–547
  - toLowerCase** method, [Character](#) class, 341
  - toLowerCase** method, [Character](#) class, 351
  - Tool tips, for components, 462
  - Top-down design, 204–205
  - Top-down implementation, 205–207
  - Top-level containers, 447–448
  - toString** method
    - [ArrayList](#) class, 433
    - [Arrays](#) class, 253

## 810 Index

**toString** method (*continued*)

**Date** class, 309

**Object** class, 429

**StringBuilder** class, 355–356

**total** variable, for storing sums, 268

**toUpperCase** method, **Character** class, 341, 351

Towers of Hanoi problem

case study, 750–752

computing recursively, 762

**TowersOfHanoi.java**, 752–754

Tracing a program, 36

**transient** keyword, serialization and, 727

Transistors, CPUs, 3

Trigonometric methods, **Math** class, 197–198

**trim** method, strings, 341

True/false (Boolean) values, 82

Truth tables, 102–103

**try** block

**InputMismatchExceptionDemo.java** example, 522

**QuotientWithException.java** example, 520

when to use exceptions, 535–536

**try-catch** blocks

catching exceptions, 525, 527–529

chained exceptions, 537–538

**CircleWithException.java** example, 532–533

rethrowing exceptions, 536–537

when to use exceptions, 535–536

Twin primes, 218

Two-dimensional arrays. *see* Arrays, two-dimensional

**.txt** files (text), 712

Type casting

between **char** and numeric types, 63

loss of precision, 67

for numeric type conversion, 56–57

## U

UI (user interface)

**BallControl.java**, 685

**ComboBoxDemo.java**, 649

creating, 641

**ListDemo.java**, 653

**MultipleWindowsDemo.java**, 661

**ScrollBarDemo.java**, 656

**SliderDemo.java**, 659

**TextAreaDemo.java**, 647

UML (Unified Modeling Language)

aggregation shown in, 382

class diagrams with, 297

diagram for **Loan** class, 376

diagram of **StackOfIntegers**, 386

diagram of static variables and methods, 312–313

Unary operators, 47

Unboxing, 396

Unchecked exceptions, 525

Underflow, floating point numbers, 45

Unicode

character data type (**char**) and, 62–65

comparing characters, 82

data input and output streams, 717

generating random numbers and, 201

text encoding, 710

text I/O vs. binary I/O, 711

Unified Modeling Language. *see* UML (Unified Modeling Language)

Uniform Resource Locators. *see* URLs (Uniform Resource Locators)

Unique addresses, for each byte of memory, 5

Universal serial bus (USB) flash drives, 7

UNIX epoch, 51

Upcasting objects, 425

**URL** class

**DisplayImagePlayAudio.java**, 694

**DisplayImageWithURL.java**, 692–693

**java.net**, 551

locating resources using, 691–692

URLs (Uniform Resource Locators)

**ReadFileFromURL.java** example, 551–552

reading data from Web, 551

USB (universal serial bus) flash drives, 7

User interface. *see* UI (user interface)

UTF-8, 717. *see also* Unicode

## V

**valueOf** methods

converting strings into arrays, 344

wrapper classes and, 395

Value-returning methods

**return** statements required by, 181

**TestReturnGradeMethod.java**, 183–185

**void** method and, 179

Variable-length argument lists, 244–245

Variables

Boolean variables. *see* Boolean variables

comparing primitive variables with reference variables, 306–308

control variables in **for** loops, 147–148

declaring, 35–36, 41

declaring array variables, 225

declaring for two-dimensional arrays, 264–265

displaying/modifying, 120

hidden, 372

identifiers, 40

indexed array variables, 226–227

naming conventions, 44

overflow, 45

overview of, 40–41

reference variables, 304

scope of, 42, 196–197, 371–372

static variables, 312–313

Vertical alignment, **AbstractButton** class, 470

- Vertical scroll bars, 656
- Vertical sliders, 657, 659
- Vertical text position, 470–471
- Virtual machines (VMs), 21. *see also* JVM (Java Virtual Machine)
- Visibility (accessibility) modifiers
  - classes and, 317–319
  - protected**, **public**, and **private**, 437–440
- Visual Basic, high-level languages, 11
- VLSI (very large-scale integration), 738
- VMs (virtual machines), 21. *see also* JVM (Java Virtual Machine)
- void** method
  - defined, 179
  - defining and invoking, 183
  - TestVoidMethod.java**, 183
- W**
- WAV file, 693
- Web, reading file data from, 551–552
- Web browsers
  - controlling applet execution and life-cycle, 677
  - viewing applets, 674–675
- Web servers, developing apps on, 628
- while** loops
  - case study: guessing numbers, 137–139
  - case study: multiple subtraction quiz, 139–141
  - case study: predicting future tuition, 157
  - deciding when to use, 150–151
  - design strategies, 139
  - do-while** loop. *see* **do-while** loop
  - input and output redirections, 143–144
  - overview of, 134–136
  - RepeatAdditionQuiz.java example, 136–137
  - sentinel-controlled, 141–143
  - syntax of, 134
- Whitespace
  - characters, 69
  - as delimiter in token reading methods, 546–547
- Wildcard import, 24
- Windows. *see* Frames (windows)
- Windows, multiple
  - Histogram.java**, 662–664
  - MultipleWindowsDemo.java**, 661–662
  - overview of, 660–661
- Windows** class, 447
- Windows OSs, 12
- Wireless networking, 8
- Wrapper classes
  - automatic conversion between primitive types and wrapper class types, 396–397
  - File** class as, 541
  - numeric, 585
  - primitive types and, 350, 393–396
- Wrapping lines of text or words, 644, 646
- Write-only streams, 729. *see also* **OutputStream** class
- X**
- XListener/XEvent** listener interface, 603–604

*This page intentionally left blank*



## Java Quick Reference

### Frequently Used Static Constants/Methods

```
Math.PI
Math.random()
Math.pow(a, b)
System.currentTimeMillis()
System.out.println(anyValue)
JOptionPane.showMessageDialog(null,
 message)
JOptionPane.showInputDialog(
 prompt-message)
Integer.parseInt(string)
Double.parseDouble(string)
Arrays.sort(type[] list)
Arrays.binarySearch(type[] list, type key)
```

### Array/Length/Initializer

```
int[] list = new int[10];
list.length;
int[] list = {1, 2, 3, 4};
```

### Multidimensional Array/Length/Initializer

```
int[][] list = new int[10][10];
list.length;
list[0].length;
int[][] list = {{1, 2}, {3, 4}};
```

### Ragged Array

```
int[][] m = {{1, 2, 3, 4},
 {1, 2, 3},
 {1, 2},
 {1}};
```

### Text File Output

```
PrintWriter output =
 new PrintWriter(filename);
output.print(...);
output.println(...);
output.printf(...);
```

### Text File Input

```
Scanner input = new Scanner(
 new File(filename));
```

### File Class

```
File file =
 new File(filename);
file.exists()
file.renameTo(File)
file.delete()
```

### Object Class

```
Object o = new Object();
o.toString();
o.equals(o1);
```

### Comparable Interface

```
c.compareTo(Comparable)
c is a Comparable object
```

### String Class

```
String s = "Welcome";
String s = new String(char[]);
int length = s.length();
char ch = s.charAt(index);
int d = s.compareTo(s1);
boolean b = s.equals(s1);
boolean b = s.startsWith(s1);
boolean b = s.endsWith(s1);
String s1 = s.trim();
String s1 = s.toUpperCase();
String s1 = s.toLowerCase();
int index = s.indexOf(ch);
int index = s.lastIndexOf(ch);
String s1 = s.substring(ch);
String s1 = s.substring(i,j);
char[] chs = s.toCharArray();
String s1 = s.replaceAll(regex, repl);
String[] tokens = s.split(regex);
```

### ArrayList Class

```
ArrayList<E> list = new ArrayList<E>();
list.add(object);
list.add(index, object);
list.clear();
Object o = list.get(index);
boolean b = list.isEmpty();
boolean b = list.contains(object);
int i = list.size();
list.remove(index);
list.set(index, object);
int i = list.indexOf(object);
int i = list.lastIndexOf(object);
```

### printf Method

```
System.out.printf("%b %c %d %f %e %s",
 true, 'A', 45, 45.5, 45.5, "Welcome");
System.out.printf("%-5d %10.2f %10.2e %8s",
 45, 45.5, 45.5, "Welcome");
```

## Java Quick Reference

### Console Input

```
Scanner input = new Scanner(System.in);
int intValue = input.nextInt();
long longValue = input.nextLong();
double doubleValue = input.nextDouble();
float floatValue = input.nextFloat();
String string = input.next();
```

### Console Output

```
System.out.println(anyValue);
```

### GUI Input Dialog

```
String string = JOptionPane.showInputDialog(
 "Enter input");
int intValue = Integer.parseInt(string);
double doubleValue =
 Double.parseDouble(string);
```

### Message Dialog

```
JOptionPane.showMessageDialog(null,
 "Enter input");
```

### Primitive Data Types

|                |            |
|----------------|------------|
| <b>byte</b>    | 8 bits     |
| <b>short</b>   | 16 bits    |
| <b>int</b>     | 32 bits    |
| <b>long</b>    | 64 bits    |
| <b>float</b>   | 32 bits    |
| <b>double</b>  | 64 bits    |
| <b>char</b>    | 16 bits    |
| <b>boolean</b> | true/false |

### Arithmetic Operators

|              |                |
|--------------|----------------|
| <b>+</b>     | addition       |
| <b>-</b>     | subtraction    |
| <b>*</b>     | multiplication |
| <b>/</b>     | division       |
| <b>%</b>     | remainder      |
| <b>++var</b> | preincrement   |
| <b>--var</b> | predecrement   |
| <b>var++</b> | postincrement  |
| <b>var--</b> | postdecrement  |

### Assignment Operators

|           |                           |
|-----------|---------------------------|
| <b>=</b>  | assignment                |
| <b>+=</b> | addition assignment       |
| <b>-=</b> | subtraction assignment    |
| <b>*=</b> | multiplication assignment |
| <b>/=</b> | division assignment       |
| <b>%=</b> | remainder assignment      |

### Relational Operators

|              |                          |
|--------------|--------------------------|
| <b>&lt;</b>  | less than                |
| <b>&lt;=</b> | less than or equal to    |
| <b>&gt;</b>  | greater than             |
| <b>&gt;=</b> | greater than or equal to |
| <b>==</b>    | equal to                 |
| <b>!=</b>    | not equal                |

### Logical Operators

|                   |                   |
|-------------------|-------------------|
| <b>&amp;&amp;</b> | short circuit AND |
| <b>  </b>         | short circuit OR  |
| <b>!</b>          | NOT               |
| <b>^</b>          | exclusive OR      |

### if Statements

```
if (condition) {
 statements;
}

if (condition) {
 statements;
}
else {
 statements;
}

if (condition1) {
 statements;
}
else if (condition2) {
 statements;
}
else {
 statements;
}
```

### switch Statements

```
switch (intExpression) {
 case value1:
 statements;
 break;
 ...
 case valuen:
 statements;
 break;
 default:
 statements;
}
```

### Loop Statements

```
while (condition) {
 statements;
}

do {
 statements;
} while (condition);

for (init; condition;
 adjustment) {
 statements;
}
```

*\*\*\*This is a bonus Web chapter*

## **CHAPTER 35**

### **Internationalization**

#### Objectives

- To describe Java's internationalization features (§35.1).
- To construct a locale with language, country, and variant (§35.2).
- To display date and time based on locale (§35.3).
- To display numbers, currencies, and percentages based on locale (§35.4).
- To develop applications for international audiences using resource bundles (§35.5).
- To specify encoding schemes for text I/O (§35.6).

## 35.1 Introduction

Many Web sites maintain several versions of Web pages so that readers can choose one written in a language they understand. Because there are so many languages in the world, it would be highly problematic to create and maintain enough different versions to meet the needs of all clients everywhere. Java comes to the rescue. Java is the first language designed from the ground up to support internationalization. In consequence, it allows your programs to be customized for any number of countries or languages without requiring cumbersome changes in the code.

Here are the major Java features that support internationalization:

### <margin note: *Unicode*>

- Java characters use *Unicode*, a 16-bit encoding scheme established by the Unicode Consortium to support the interchange, processing, and display of written texts in the world's diverse languages. The use of Unicode encoding makes it easy to write Java programs that can manipulate strings in any international language. (To see all the Unicode characters, visit [mindprod.com/jgloss/reuters.html](http://mindprod.com/jgloss/reuters.html).)

### <margin note: *Locale class*>

- Java provides the *Locale* class to encapsulate information about a specific locale. A *Locale* object determines how locale-sensitive information, such as date, time, and number, is displayed, and how locale-sensitive operations, such as sorting strings, are performed. The classes for formatting date, time, and numbers, and for sorting strings are grouped in the *java.text* package.

### <margin note: *ResourceBundle*>

- Java uses the *ResourceBundle* class to separate locale-specific information, such as status messages and GUI component labels, from the program. The information is stored outside the source code and can be accessed and loaded dynamically at runtime from a *ResourceBundle*, rather than hard-coded into the program.

In this chapter, you will learn how to format dates, numbers, currencies, and percentages for different regions, countries, and languages. You will also learn how to use resource bundles to define which images and strings are used by a component, depending on the user's locale and preferences.

## 35.2 The *Locale* Class

A *Locale* object represents a geographical, political, or cultural region in which a specific language or custom is used. For example, Americans speak English, and the Chinese speak Chinese. The conventions for formatting dates, numbers, currencies, and percentages may differ from one country to another. The Chinese, for instance, use year/month/day to represent the date, while Americans use month/day/year. It is important to realize that locale is not defined only by country. For example, Canadians speak either Canadian English or Canadian French, depending on which region of Canada they reside in.

### NOTE

#### <margin note: *locale property in Component*>

Every Swing user-interface class has a *locale* property inherited from the *Component* class.

To create a *Locale* object, use one of the three constructors with a specified language and optional country and variant, as shown in Figure 35.1.

| java.util.Locale                                            |                                                                                                                       |
|-------------------------------------------------------------|-----------------------------------------------------------------------------------------------------------------------|
| +Locale(language: String)                                   | Constructs a locale from a language code.                                                                             |
| +Locale(language: String, country: String)                  | Constructs a locale from language and country codes.                                                                  |
| +Locale(language: String, country: String, variant: String) | Constructs a locale from language, country, and variant codes.                                                        |
| +getCountry(): String                                       | Returns the country/region code for this locale.                                                                      |
| +getLanguage(): String                                      | Returns the language code for this locale.                                                                            |
| +getVariant(): String                                       | Returns the variant code for this locale.                                                                             |
| +getDefault(): Locale                                       | Gets the default locale on the machine.                                                                               |
| +getDisplayCountry(): String                                | Returns the name of the country as expressed in the current locale.                                                   |
| +getDisplayLanguage(): String                               | Returns the name of the language as expressed in the current locale.                                                  |
| +getDisplayName(): String                                   | Returns the name for the locale. For example, the name is <u>Chinese (China)</u> for the locale <u>Locale.CHINA</u> . |
| +getDisplayVariant(): String                                | Returns the name for the locale's variant if it exists.                                                               |
| +getAvailableLocales(): Locale[]                            | Returns the available locales in an array.                                                                            |

**Figure 35.1**

The *Locale* class encapsulates a locale.

**<margin note: language>**

The *language* should be a valid language code—that is, one of the lowercase two-letter codes defined by ISO-639. For example, *zh* stands for Chinese, *da* for Danish, *en* for English, *de* for German, and *ko* for Korean. Table 35.1 lists the language codes.

**<margin note: country>**

The country should be a valid ISO country code—that is, one of the uppercase, two-letter codes defined by ISO-3166. For example, *CA* stands for Canada, *CN* for China, *DK* for Denmark, *DE* for Germany, and *US* for the United States. Table 35.2 lists the country codes.

Table 31.1 Common Language Codes

| Code | Language | Code | Language   |
|------|----------|------|------------|
| da   | Danish   | ja   | Japanese   |
| de   | German   | ko   | Korean     |
| el   | Greek    | nl   | Dutch      |
| en   | English  | no   | Norwegian  |
| es   | Spanish  | pt   | Portuguese |
| fi   | Finnish  | sv   | Swedish    |
| fr   | French   | tr   | Turkish    |
| it   | Italian  | zh   | Chinese    |

Table 31.2 Common Country Codes

| Code | Country        | Code | Country       |
|------|----------------|------|---------------|
| AT   | Austria        | IE   | Ireland       |
| BE   | Belgium        | HK   | Hong Kong     |
| CA   | Canada         | IT   | Italy         |
| CH   | Switzerland    | JP   | Japan         |
| CN   | China          | KR   | Korea         |
| DE   | Germany        | NL   | Netherlands   |
| DK   | Denmark        | NO   | Norway        |
| ES   | Spain          | PT   | Portugal      |
| FI   | Finland        | SE   | Sweden        |
| FR   | France         | TR   | Turkey        |
| GB   | United Kingdom | TW   | Taiwan        |
| GR   | Greece         | US   | United States |

**<margin note: variant>**

The argument variant is rarely used and is needed only for exceptional or system-dependent situations to designate information specific to a browser or vendor. For example, the Norwegian language has two sets of spelling rules, a

traditional one called *bokmål* and a new one called *nynorsk*. The locale for traditional spelling would be created as follows:

```
new Locale("no", "NO", "B");
```

For convenience, the `Locale` class contains many predefined locale constants. `Locale.CANADA` is for the country Canada and language English; `Locale.CANADA_FRENCH` is for the country Canada and language French. Several other common constants are:

```
Locale.US, Locale.UK, Locale.FRANCE, Locale.GERMANY,
Locale.ITALY, Locale.CHINA, Locale.KOREA, Locale.JAPAN, and
```

The `Locale` class also provides the following constants based on language:

```
Locale.CHINESE, Locale.ENGLISH, Locale.FRENCH,
Locale.GERMAN, Locale.ITALIAN, Locale.JAPANESE,
Locale.KOREAN, Locale.SIMPLIFIED_CHINESE, and
Locale.TRADITIONAL_CHINESE
```

TIP:

You can invoke the static method `getAvailableLocales()` in the `Locale` class to obtain all the available locales supported in the system. For example,

```
Locale[] availableLocales = Calendar.getAvailableLocales();
```

returns all the locales in an array.

TIP:

Your machine has a default locale. You may override it by supplying the language and region parameters when you run the program, as follows:

```
java -Duser.language=zh -Duser.region=CN MainClass
```

**<margin note: locale sensitive>**

An operation that requires a `Locale` to perform its task is called *locale sensitive*. Displaying a number such as a date or time, for example, is a locale-sensitive operation; the number should be formatted according to the customs and conventions of the user's locale. The sections that follow introduce locale-sensitive operations.

### 35.3 Displaying Date and Time

**<margin note: Date>**

**<margin note: Calendar>**

Applications often need to obtain date and time. Java provides a system-independent encapsulation of date and time in the `java.util.Date` class; it also provides `java.util.TimeZone` for dealing with time zones, and `java.util.Calendar` for extracting detailed information from `Date`. Different locales have different conventions for displaying date and time. Should the year, month, or day be displayed first? Should slashes, periods, or colons be used to separate fields of the date? What are the names of the months in the language? The `java.text.DateFormat` class can be used to format date and time in a locale-sensitive way for display to the user. The `Date` class was introduced in §8.6.1, "The `Date` Class," and the `Calendar` class and its subclass `GregorianCalendar` were introduced in §15.4, "Case Study: `Calendar` and `GregorianCalendar`."

### 35.3.1 The `TimeZone` Class

**<margin note: `TimeZone`>**

`TimeZone` represents a time zone offset and also figures out daylight savings. To get a `TimeZone` object for a specified time zone ID, use `TimeZone.getTimeZone(id)`. To set a time zone in a `Calendar` object, use the `setTimeZone` method with a time zone ID. For example, `cal.setTimeZone(TimeZone.getTimeZone("CST"))` sets the time zone to Central Standard Time. To find all the available time zones supported in Java, use the static method `getAvailableIDs()` in the `TimeZone` class. In general, the international time zone ID is a string in the form of continent/city like Europe/Berlin, Asia/Taipei, and America/Washington. You can also use the static method `getDefault()` in the `TimeZone` class to obtain the default time zone on the host machine.

### 35.3.2 The `DateFormat` Class

**<margin note: `DateFormat`>**

The `DateFormat` class can be used to format date and time in a number of styles. The `DateFormat` class supports several standard formatting styles. To format date and time, simply create an instance of `DateFormat` using one of the three static methods `getDateInstance`, `getTimeInstance`, and `getDateTimeInstance` and apply the `format(Date)` method on the instance, as shown in Figure 35.2.

| <code>java.text.DateFormat</code>                                                              |                                                                                                         |
|------------------------------------------------------------------------------------------------|---------------------------------------------------------------------------------------------------------|
| <code>+format(date: Date): String</code>                                                       | Formats a date into a date/time string.                                                                 |
| <code>+getDateInstance(): DateFormat</code>                                                    | Gets the date formatter with the default formatting style for the default locale.                       |
| <code>+getDateInstance(dateStyle: int): DateFormat</code>                                      | Gets the date formatter with the given formatting style for the default locale.                         |
| <code>+getDateInstance(dateStyle: int, aLocale: Locale): DateFormat</code>                     | Gets the date formatter with the given formatting style for the given locale.                           |
| <code>+getDateTimeInstance(): DateFormat</code>                                                | Gets the date and time formatter with the default formatting style for the default locale.              |
| <code>+getDateTimeInstance(dateStyle: int, timeStyle: int): DateFormat</code>                  | Gets the date and time formatter with the given date and time formatting styles for the default locale. |
| <code>+getDateTimeInstance(dateStyle: int, timeStyle: int, aLocale: Locale): DateFormat</code> | Gets the date and time formatter with the given formatting styles for the given locale.                 |
| <code>+getInstance(): DateFormat</code>                                                        | Gets a default date and time formatter that uses the SHORT style for both the date and the time.        |

**Figure 35.2**

The `DateFormat` class formats date and time.

The `dateStyle` and `timeStyle` are one of the following constants:

`DateFormat.SHORT`, `DateFormat.MEDIUM`, `DateFormat.LONG`, `DateFormat.FULL`. The exact result depends on the locale, but generally,

- `SHORT` is completely numeric, such as 7/24/98 (for date) and 4:49 PM (for time).
- `MEDIUM` is longer, such as 24-Jul-98 (for date) and 4:52:09 PM (for time).
- `LONG` is even longer, such as July 24, 1998 (for date) and 4:53:16 PM EST (for time).
- `FULL` is completely specified, such as Friday, July 24, 1998 (for date) and 4:54:13 o'clock PM EST (for time).

The statements given below display current time with a specified time zone (CST), formatting style (full date and full time), and locale (US).

```
GregorianCalendar calendar = new GregorianCalendar();
```

```

DateFormat formatter = DateFormat.getDateTimeInstance(
 DateFormat.FULL, DateFormat.FULL, Locale.US);
TimeZone timeZone = TimeZone.getTimeZone("CST");
formatter.setTimeZone(timeZone);
System.out.println("The local time is " +
 formatter.format(calendar.getTime()));

```

### 35.3.3 The `SimpleDateFormat` Class

*<margin note: `SimpleDateFormat`>*

The date and time formatting subclass, `SimpleDateFormat`, enables you to choose any user-defined pattern for date and time formatting. The constructor shown below can be used to create a `SimpleDateFormat` object, and the object can be used to convert a `Date` object into a string with the desired format.

```
public SimpleDateFormat(String pattern)
```

The parameter `pattern` is a string consisting of characters with special meanings. For example, `y` means year, `M` means month, `d` means day of the month, `G` is for era designator, `h` means hour, `m` means minute of the hour, `s` means second of the minute, and `z` means time zone. Therefore, the following code will display a string like "Current time is 1997.11.12 AD at 04:10:18 PST" because the pattern is "yyyy.MM.dd G 'at' hh:mm:ss z".

```

SimpleDateFormat formatter
 = new SimpleDateFormat("yyyy.MM.dd G 'at' hh:mm:ss z");
date currentTime = new Date();
String dateString = formatter.format(currentTime);
System.out.println("Current time is " + dateString);

```

### 35.3.4 The `DateFormatSymbols` Class

*<margin note: `DateFormatSymbols`>*

The `DateFormatSymbols` class encapsulates localizable date-time formatting data, such as the names of the months and the names of the days of the week, as shown in Figure 35.3.

| java.text.DateFormatSymbols                     |                                                                |
|-------------------------------------------------|----------------------------------------------------------------|
| +DateFormatSymbols()                            | Constructs a DateFormatSymbols object for the default locale.  |
| +DateFormatSymbols(Locale locale)               | Constructs a DateFormatSymbols object by for the given locale. |
| +getAmPmStrings(): String[]                     | Gets AM/PM strings. For example: "AM" and "PM".                |
| +getEras(): String[]                            | Gets era strings. For example: "AD" and "BC".                  |
| +getMonths(): String[]                          | Gets month strings. For example: "January", "February", etc.   |
| +setMonths(newMonths: String[]): void           | Sets month strings for this locale.                            |
| +getShortMonths(): String[]                     | Gets short month strings. For example: "Jan", "Feb", etc.      |
| +setShortMonths(newShortMonths: String[]): void | Sets short month strings for this locale.                      |
| +getWeekdays(): String[]                        | Gets weekday strings. For example: "Sunday", "Monday", etc.    |
| +setWeekdays(newWeekdays: String[]): void       | Sets weekday strings.                                          |
| +getShortWeekdays(): String[]                   | Gets short weekday strings. For example: "Sun", "Mon", etc.    |
| +setShortWeekdays(newWeekdays: String[]): void  | Sets short weekday strings. For example: "Sun", "Mon", etc.    |

**Figure 35.3**

The `DateFormatSymbols` class encapsulates localizable date-time formatting data.

For example, the following statement displays the month names and weekday names for the default locale.



```

DateFormatSymbols symbols = new DateFormatSymbols();
String[] monthNames = symbols.getMonths();
for (int i = 0; i < monthNames.length; i++) {
 System.out.println(monthNames[i]); // Display January, ...
}

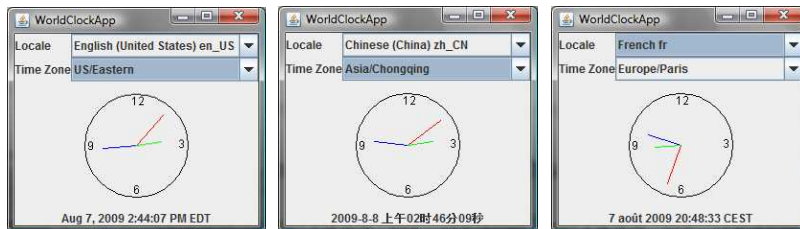
String[] weekdayNames = symbols.getWeekdays();
for (int i = 0; i < weekdayNames.length; i++) {
 System.out.println(weekdayNames[i]); // Display Sunday, Monday, ...
}

```

The following two examples demonstrate how to display date, time, and calendar based on locale. The first example creates a clock and displays date and time in locale-sensitive format. The second example displays several different calendars with the names of the days shown in the appropriate local language.

### 35.3.5 Example: Displaying an International Clock

Write a program that displays a clock to show the current time based on the specified locale and time zone. The locale and time zone are selected from the combo boxes that contain the available locales and time zones in the system, as shown in Figure 35.4.



**Figure 35.4**

*The program displays a clock that shows the current time with the specified locale and time zone.*

Here are the major steps in the program:

1. Create a subclass of `JPanel` named `WorldClock` (Listing 35.1) to contain an instance of the `StillClock` class (developed in Listing 13.10, `StillClock.java`), and place it in the center. Create a `JLabel` to display the digit time, and place it in the south. Use the `GregorianCalendar` class to obtain the current time for a specific locale and time zone.
2. Create a subclass of `JPanel` named `WorldClockControl` (Listing 35.2) to contain an instance of `WorldClock` and two instances of `JComboBox` for selecting locales and time zones.
3. Create an applet named `WorldClockApp` (Listing 35.3) to contain an instance of `WorldClockControl` and enable the applet to run standalone. The relationship among these classes is shown in Figure 35.5.

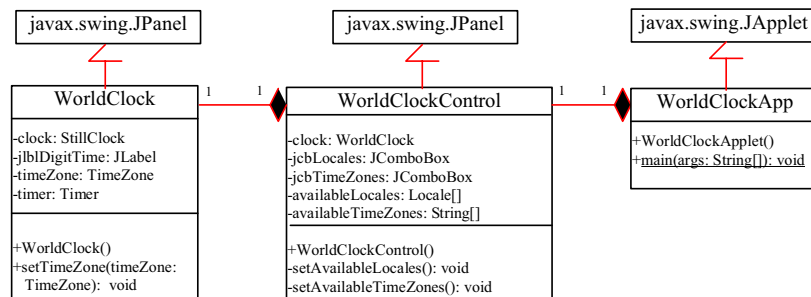


Figure 35.5

*WorldClockApp* contains *WorldClockControl*, and *WorldClockControl* contains *WorldClock*.

#### Listing 35.1 WorldClock.java

<margin note line 11: create timer>

<margin note line 12: create clock>

<margin note line 26: timer listener class>

```

1 import javax.swing.*;
2 import java.awt.*;
3 import java.awt.event.*;
4 import java.util.Calendar;
5 import java.util.TimeZone;
6 import java.util.GregorianCalendar;
7 import java.text.*;
8
9 public class WorldClock extends JPanel {
10 private TimeZone timeZone = TimeZone.getTimeZone("EST");
11 private Timer timer = new Timer(1000, new TimerListener());
12 private StillClock clock = new StillClock();
13 private JLabel jlblDigitTime = new JLabel("", JLabel.CENTER);
14
15 public WorldClock() {
16 setLayout(new BorderLayout());
17 add(clock, BorderLayout.CENTER);
18 add(jlblDigitTime, BorderLayout.SOUTH);
19 timer.start();
20 }
21
22 public void setTimeZone(TimeZone timeZone) {
23 this.timeZone = timeZone;
24 }
25
26 private class TimerListener implements ActionListener {
27 @Override
28 public void actionPerformed(ActionEvent e) {
29 Calendar calendar =
30 new GregorianCalendar(timeZone, getLocale());
31 clock.setHour(calendar.get(Calendar.HOUR));
32 clock.setMinute(calendar.get(Calendar.MINUTE));
33 clock.setSecond(calendar.get(Calendar.SECOND));
34
35 // Display digit time on the label
36 DateFormat formatter = DateFormat.getDateInstance

```

```

37 (DateFormat.MEDIUM, DateFormat.LONG, getLocale());
38 formatter.setTimeZone(timeZone);
39 lblDigitTime.setText(formatter.format(calendar.getTime()));
40 }
41 }
42 }

```

**Listing 35.2 WorldClockControl.java**

*<margin note line 8: locales>*  
*<margin note line 9: time zones>*  
*<margin note line 12: combo boxes>*  
*<margin note line 16: create clock>*  
*<margin note line 31: create UI>*  
*<margin note line 53: new locale>*  
*<margin note line 59: new time zone>*

```

1 import javax.swing.*;
2 import java.awt.*;
3 import java.awt.event.*;
4 import java.util.*;
5
6 public class WorldClockControl extends JPanel {
7 // Obtain all available locales and time zone ids
8 private Locale[] availableLocales = Locale.getAvailableLocales();
9 private String[] availableTimeZones = TimeZone.getAvailableIDs();
10
11 // Comboxes to display available locales and time zones
12 private JComboBox jcbLocales = new JComboBox();
13 private JComboBox jcbTimeZones = new JComboBox();
14
15 // Create a clock
16 private WorldClock clock = new WorldClock();
17
18 public WorldClockControl() {
19 // Initialize jcbLocales with all available locales
20 setAvailableLocales();
21
22 // Initialize jcbTimeZones with all available time zones
23 setAvailableTimeZones();
24
25 // Initialize locale and time zone
26 clock.setLocale(
27 availableLocales[jcbLocales.getSelectedIndex()]);
28 clock.setTimeZone(TimeZone.getTimeZone(
29 availableTimeZones[jcbTimeZones.getSelectedIndex()]));
30
31 JPanel panel1 = new JPanel();
32 panel1.setLayout(new GridLayout(2, 1));
33 panel1.add(new JLabel("Locale"));
34 panel1.add(new JLabel("Time Zone"));
35 JPanel panel2 = new JPanel();
36
37 panel2.setLayout(new GridLayout(2, 1));
38 panel2.add(jcbLocales, BorderLayout.CENTER);
39 panel2.add(jcbTimeZones, BorderLayout.CENTER);
40
41 JPanel panel3 = new JPanel();
42 panel3.setLayout(new BorderLayout());

```

```

43 panel3.add(panel1, BorderLayout.WEST);
44 panel3.add(panel2, BorderLayout.CENTER);
45
46 setLayout(new BorderLayout());
47 add(panel3, BorderLayout.NORTH);
48 add(clock, BorderLayout.CENTER);
49
50 jcbLocales.addActionListener(new ActionListener() {
51 @Override
52 public void actionPerformed(ActionEvent e) {
53 clock.setLocale(
54 availableLocales[jcbLocales.getSelectedIndex()]);
55 }
56 });
57 jcbTimeZones.addActionListener(new ActionListener() {
58 @Override
59 public void actionPerformed(ActionEvent e) {
60 clock.setTimeZone(TimeZone.getTimeZone(
61 availableTimeZones[jcbTimeZones.getSelectedIndex()]));
62 }
63 });
64 }
65
66 private void setAvailableLocales() {
67 for (int i = 0; i < availableLocales.length; i++) {
68 jcbLocales.addItem(availableLocales[i].getDisplayName() + " "
69 + availableLocales[i].toString());
70 }
71 }
72
73 private void setAvailableTimeZones() {
74 // Sort time zones
75 Arrays.sort(availableTimeZones);
76 for (int i = 0; i < availableTimeZones.length; i++) {
77 jcbTimeZones.addItem(availableTimeZones[i]);
78 }
79 }
80 }

```

### Listing 35.3 WorldClockApp.java

*<margin note line 8: main method omitted>*

```

1 import javax.swing.*;
2
3 public class WorldClockApp extends JApplet {
4 /** Construct the applet */
5 public WorldClockApp() {
6 add(new WorldClockControl());
7 }
8 }

```

The `WorldClock` class uses `GregorianCalendar` to obtain a `Calendar` object for the specified locale and time zone (line 28). Since `WorldClock` extends `JPanel`, and every GUI component has the `locale` property, the locale for the calendar is obtained from the `WorldClock` using `getLocale()` (line 28).

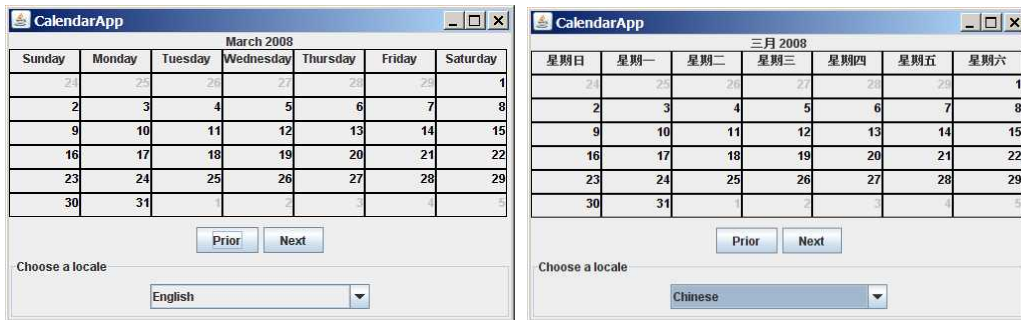
An instance of `StillClock` is created (line 12) and placed in the panel (line 17). The clock time is updated every one second using the current `Calendar` object in lines 28-35.

An instance of `DateFormat` is created (lines 34-35) and is used to format the date in accordance with the locale (line 37).

The `WorldClockControl` class contains an instance of `WorldClock` and two combo boxes. The combo boxes store all the available locales and time zones (lines 64-77). The newly selected locale and time zone are set in the clock (lines 50-61) and used to display a new time based on the current locale and time zone.

### 35.3.6 Example: Displaying a Calendar

Write a program that displays a calendar based on the specified locale, as shown in Figure 35.6. The user can specify a locale from a combo box that consists of a list of all the available locales supported by the system. When the program starts, the calendar for the current month of the year is displayed. The user can use the `Prior` and `Next` buttons to browse the calendar.



**Figure 35.6**

*The calendar applet displays a calendar with a specified locale.*

Here are the major steps in the program:

1. Create a subclass of `JPanel` named `CalendarPanel` (Listing 35.4) to display the calendar for the given year and month based on the specified locale and time zone.
2. Create an applet named `CalendarApp` (Listing 35.5). Create a panel to hold an instance of `CalendarPanel` and two buttons, `Prior` and `Next`. Place the panel in the center of the applet. Create a combo box and place it in the south of the applet. The relationships among these classes are shown in Figure 35.7.

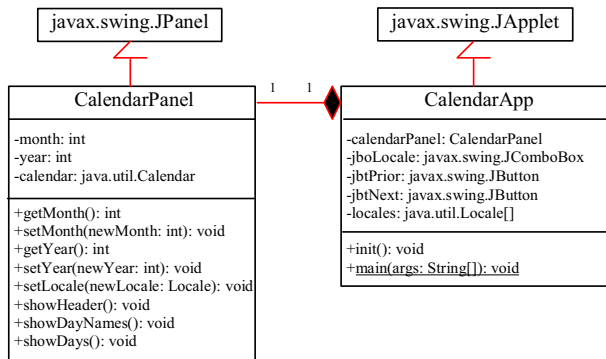


Figure 35.7

*CalendarApp* contains *CalendarPanel*.

Listing 35.4 *CalendarPanel.java*

```

<margin note line 9: label for header>
<margin note line 12: labels for days>
<margin note line 14: calendar>
<margin note line 15: month>
<margin note line 16: year>
<margin note line 19: panel for days>
<margin note line 23: create labels>
<margin note line 32: place header>
<margin note line 33: place day>
<margin note line 36: get current calendar>
<margin note line 39: update calendar>
<margin note line 42: show header>
<margin note line 43: show days>
<margin note line 47: show header>
<margin note line 51: new header>
<margin note line 57: get day names>
<margin note line 69: empty jpDays panel>
<margin note line 71: display day names>
<margin note line 82: days before this month>
<margin note line 92: days in this month>
<margin note line 101: days after this month>
<margin note line 108: repaint jpDays>
<margin note line 113: update calendar>
<margin note line 125: set new month>
<margin note line 138: set new year>
<margin note line 146: set new locale>

```

```

1 import java.awt.*;
2 import javax.swing.*;
3 import javax.swing.border.LineBorder;
4 import java.util.*;
5 import java.text.*;
6
7 public class CalendarPanel extends JPanel {
8 // The header label
9 private JLabel jlblHeader = new JLabel(" ", JLabel.CENTER);
10
11 // Maximun number of labels to display day names and days
12 private JLabel[] jlblDay = new JLabel[49];

```

```

13
14 private java.util.Calendar calendar;
15 private int month; // The specified month
16 private int year; // The specified year
17
18 // Panel jpDays to hold day names and days
19 private JPanel jpDays = new JPanel(new GridLayout(0, 7));
20
21 public CalendarPanel() {
22 // Create labels for displaying days
23 for (int i = 0; i < 49; i++) {
24 JLabel jlblDay[i] = new JLabel();
25 jlblDay[i].setBorder(new LineBorder(Color.black, 1));
26 jlblDay[i].setHorizontalAlignment(JLabel.RIGHT);
27 jlblDay[i].setVerticalAlignment(JLabel.TOP);
28 }
29
30 // Place header and calendar body in the panel
31 this.setLayout(new BorderLayout());
32 this.add(jlblHeader, BorderLayout.NORTH);
33 this.add(jpDays, BorderLayout.CENTER);
34
35 // Set current month and year
36 calendar = new GregorianCalendar();
37 month = calendar.get(Calendar.MONTH);
38 year = calendar.get(Calendar.YEAR);
39 updateCalendar();
40
41 // Show calendar
42 showHeader();
43 showDays();
44 }
45
46 /** Update the header based on locale */
47 private void showHeader() {
48 SimpleDateFormat sdf =
49 new SimpleDateFormat("MMMM yyyy", getLocale());
50 String header = sdf.format(calendar.getTime());
51 jlblHeader.setText(header);
52 }
53
54 /** Update the day names based on locale */
55 private void showDayNames() {
56 DateFormatSymbols dfs = new DateFormatSymbols(getLocale());
57 String dayNames[] = dfs.getWeekdays();
58
59 // jlblDay[0], jlblDay[1], ..., jlblDay[6] for day names
60 for (int i = 0; i < 7; i++) {
61 jlblDay[i].setText(dayNames[i + 1]);
62 jlblDay[i].setHorizontalAlignment(JLabel.CENTER);
63 jpDays.add(jlblDay[i]); // Add to jpDays
64 }
65 }
66
67 /** Display days */
68 public void showDays() {
69 jpDays.removeAll(); // Remove all labels from jpDays
70

```

```

71 showDayNames(); // Display day names
72
73 // Get the day of the first day in a month
74 int startingDayOfMonth = calendar.get(Calendar.DAY_OF_WEEK);
75
76 // Fill the calendar with the days before this month
77 Calendar cloneCalendar = (Calendar)calendar.clone();
78 cloneCalendar.add(Calendar.DATE, -1); // Becomes preceding month
79 int daysInPrecedingMonth = cloneCalendar.getActualMaximum(
80 Calendar.DAY_OF_MONTH);
81
82 for (int i = 0; i < startingDayOfMonth - 1; i++) {
83 jlblDay[i + 7].setForeground(Color.LIGHT_GRAY);
84 jlblDay[i + 7].setText(daysInPrecedingMonth -
85 startingDayOfMonth + 2 + i + "");
86 jpDays.add(jlblDay[i + 7]); // Add to jpDays
87 }
88
89 // Display days of this month
90 int daysInCurrentMonth = calendar.getActualMaximum(
91 Calendar.DAY_OF_MONTH);
92 for (int i = 1; i <= daysInCurrentMonth; i++) {
93 jlblDay[i - 2 + startingDayOfMonth + 7].
94 setForeground(Color.black);
95 jlblDay[i - 2 + startingDayOfMonth + 7].setText(i + "");
96 jpDays.add(jlblDay[i - 2 + startingDayOfMonth + 7]);
97 }
98
99 // Fill the calendar with the days after this month
100 int j = 1;
101 for (int i = daysInCurrentMonth - 1 + startingDayOfMonth + 7;
102 i % 7 != 0; i++) {
103 jlblDay[i].setForeground(Color.LIGHT_GRAY);
104 jlblDay[i].setText(j++ + "");
105 jpDays.add(jlblDay[i]); // Add to jpDays
106 }
107
108 jpDays.repaint(); // Repaint the labels in jpDays
109 }
110
111 /** Set the calendar to the first day of the
112 * specified month and year */
113 private void updateCalendar() {
114 calendar.set(Calendar.YEAR, year);
115 calendar.set(Calendar.MONTH, month);
116 calendar.set(Calendar.DATE, 1);
117 }
118
119 /** Return month */
120 public int getMonth() {
121 return month;
122 }
123
124 /** Set a new month */
125 public void setMonth(int newMonth) {
126 month = newMonth;
127 updateCalendar();
128 showHeader();

```



```

129 showDays();
130 }
131
132 /** Return year */
133 public int getYear() {
134 return year;
135 }
136
137 /** Set a new year */
138 public void setYear(int newYear) {
139 year = newYear;
140 updateCalendar();
141 showHeader();
142 showDays();
143 }
144
145 /** Set a new locale */
146 public void changeLocale(Locale newLocale) {
147 setLocale(newLocale);
148 showHeader();
149 showDays();
150 }
151 }

```

`CalendarPanel` is created to control and display the calendar. It displays the month and year in the header, and the day names and days in the calendar body. The header and day names are locale sensitive.

**<margin note: showHeader>**

The `showHeader` method (lines 47-52) displays the calendar title in a form like "MMMM yyyy". The `SimpleDateFormat` class used in the `showHeader` method is a subclass of `DateFormat`. `SimpleDateFormat` allows you to customize the date format to display the date in various nonstandard styles.

**<margin note: showDayNames>**

The `showDayNames` method (lines 55-65) displays the day names in the calendar. The `DateFormatSymbols` class used in the `showDayNames` method is a class for encapsulating localizable date-time formatting data, such as the names of the months, the names of the days of the week, and the time-zone data. The `getWeekdays` method is used to get an array of day names.

**<margin note: showDays>**

The `showDays` method (lines 68-109) displays the days for the specified month of the year. As you can see in Figure 35.6, the labels before the current month are filled with the last few days of the preceding month, and the labels after the current month are filled with the first few days of the next month. To fill the calendar with the days before the current month, a clone of `calendar`, named `cloneCalendar`, is created to obtain the days for the preceding month (line 77). `cloneCalendar` is a copy of `calendar` with separate memory space. Thus you can change the properties of `cloneCalendar` without corrupting the `calendar` object. The `clone()` method is defined in the `Object` class, which was introduced in §15.7, "The `Cloneable` Interface." You can clone any object as long as its defining class implements the `Cloneable` interface. The `Calendar` class implements `Cloneable`.

The `cloneCalendar.getActualMaximum(Calendar.DAY_OF_MONTH)` method (lines 90-91) returns the number of days in the month for the specified calendar.

**Listing 35.5 CalendarApp.java**

<margin note line 9: calendar panel>  
 <margin note line 12: combo box>  
 <margin note line 15: locales>  
 <margin note line 23: create UI>  
 <margin note line 50: set a new locale>  
 <margin note line 60: previous month>  
 <margin note line 69: next month>  
 <margin note line 75: main method omitted>

```

1 import java.awt.*;
2 import java.awt.event.*;
3 import javax.swing.*;
4 import javax.swing.border.*;
5 import java.util.*;
6
7 public class CalendarApp extends JApplet {
8 // Create a CalendarPanel for showing calendars
9 private CalendarPanel calendarPanel = new CalendarPanel();
10
11 // Combo box for selecting available locales
12 private JComboBox jcboLocale = new JComboBox();
13
14 // Declare locales to store available locales
15 private Locale locales[] = Calendar.getAvailableLocales();
16
17 // Buttons Prior and Next for displaying prior and next month
18 private JButton jbtPrior = new JButton("Prior");
19 private JButton jbtNext = new JButton("Next");
20
21 /** Initialize the applet */
22 public void init() {
23 // Panel jpLocale to hold the combo box for selecting locales
24 JPanel jpLocale = new JPanel(new BorderLayout());
25 jpLocale.setBorder(new TitledBorder("Choose a locale"));
26 jpLocale.add(jcboLocale);
27
28 // Initialize the combo box to add locale names
29 for (int i = 0; i < locales.length; i++)
30 jcboLocale.addItem(locales[i].getDisplayName());
31
32 // Panel jpButtons to hold buttons
33 JPanel jpButtons = new JPanel(new BorderLayout());
34 jpButtons.add(jbtPrior);
35 jpButtons.add(jbtNext);
36
37 // Panel jpCalendar to hold calendarPanel and buttons
38 JPanel jpCalendar = new JPanel(new BorderLayout());
39 jpCalendar.add(calendarPanel, BorderLayout.CENTER);
40 jpCalendar.add(jpButtons, BorderLayout.SOUTH);
41
42 // Place jpCalendar and jpLocale to the applet
43 add(jpCalendar, BorderLayout.CENTER);
44 add(jpLocale, BorderLayout.SOUTH);
45
46 // Register listeners
47 jcboLocale.addActionListener(new ActionListener() {
48 @Override
49 public void actionPerformed(ActionEvent e) {

```

```

50 if (e.getSource() == jcbLocale)
51 calendarPanel.changeLocale(
52 locales[jcbLocale.getSelectedIndex()]);
53 }
54 });
55
56 jbtPrior.addActionListener(new ActionListener() {
57 @Override
58 public void actionPerformed(ActionEvent e) {
59 int currentMonth = calendarPanel.getMonth();
60 if (currentMonth == 0) // The previous month is 11 for Dec
61 calendarPanel.setYear(calendarPanel.getYear() - 1);
62 calendarPanel.setMonth((currentMonth - 1) % 12);
63 });
64
65 jbtNext.addActionListener(new ActionListener() {
66 @Override
67 public void actionPerformed(ActionEvent e) {
68 int currentMonth = calendarPanel.getMonth();
69 if (currentMonth == 11) // The next month is 0 for Jan
70 calendarPanel.setYear(calendarPanel.getYear() + 1);
71
72 calendarPanel.setMonth((currentMonth + 1) % 12);
73 });
74
75 calendarPanel.changeLocale(
76 locales[jcbLocale.getSelectedIndex()]);
77 }
78 }

```

`CalendarApp` creates the user interface and handles the button actions and combo box item selections for locales. The `Calendar.getAvailableLocales()` method (line 15) is used to find all the available locales that have calendars. Its `getDisplayName()` method returns the name of each locale and adds the name to the combo box (line 30). When the user selects a locale name in the combo box, a new locale is passed to `calendarPanel`, and a new calendar is displayed based on the new locale (lines 72-73).

#### 35.4 Formatting Numbers

Formatting numbers is highly locale dependent. For example, number 5000.555 is displayed as 5,000.555 in the United States, but as 5 000,555 in France and as 5.000,555 in Germany.

Numbers are formatted using the `java.text.NumberFormat` class, an abstract base class that provides the methods for formatting and parsing numbers, as shown in Figure 35.8.

| <i>java.text.NumberFormat</i>                                  |                                                                                                                                                        |
|----------------------------------------------------------------|--------------------------------------------------------------------------------------------------------------------------------------------------------|
| <code>+getInstance(): NumberFormat</code>                      | Returns a default number format for the default locale.                                                                                                |
| <code>+getInstance(locale: Locale): NumberFormat</code>        | Returns a default number format for the specified locale.                                                                                              |
| <code>+getIntegerInstance(): NumberFormat</code>               | Returns an integer number format for the default locale.                                                                                               |
| <code>+getIntegerInstance(locale: Locale): NumberFormat</code> | Returns an integer number format for the specified locale.                                                                                             |
| <code>+getCurrencyInstance(): NumberFormat</code>              | Returns a currency format for the current default locale.                                                                                              |
| <code>+getNumberInstance(): NumberFormat</code>                | Same as <code>getInstance()</code> .                                                                                                                   |
| <code>+getNumberInstance(locale: Locale): NumberFormat</code>  | Same as <code>getInstance(locale)</code> .                                                                                                             |
| <code>+getPercentInstance(): NumberFormat</code>               | Returns a percentage format for the default locale.                                                                                                    |
| <code>+getPercentInstance(locale: Locale): NumberFormat</code> | Returns a percentage format for the specified locale.                                                                                                  |
| <code>+format (number: double): String</code>                  | Formats a floating-point number.                                                                                                                       |
| <code>+format (number: long): String</code>                    | Formats an integer.                                                                                                                                    |
| <code>+getMaximumFractionDigits(): int</code>                  | Returns the maximum number of allowed fraction digits.                                                                                                 |
| <code>+setMaximumFractionDigits(newValue: int): void</code>    | Sets the maximum number of allowed fraction digits.                                                                                                    |
| <code>+getMinimumFractionDigits(): int</code>                  | Returns the minimum number of allowed fraction digits.                                                                                                 |
| <code>+setMinimumFractionDigits(newValue: int): void</code>    | Sets the minimum number of allowed fraction digits.                                                                                                    |
| <code>+getMaximumIntegerDigits(): int</code>                   | Returns the maximum number of allowed integer digits in a fraction number.                                                                             |
| <code>+setMaximumIntegerDigits(newValue: int): void</code>     | Sets the maximum number of allowed integer digits in a fraction number.                                                                                |
| <code>+getMinimumIntegerDigits(): int</code>                   | Returns the minimum number of allowed integer digits in a fraction number.                                                                             |
| <code>+setMinimumIntegerDigits(newValue: int): void</code>     | Sets the minimum number of allowed integer digits in a fraction number.                                                                                |
| <code>+isGroupingUsed(): boolean</code>                        | Returns true if grouping is used in this format. For example, in the English locale, with grouping on, the number 1234567 is formatted as "1,234,567". |
| <code>+setGroupingUsed(newValue: boolean): void</code>         | Sets whether or not grouping will be used in this format.                                                                                              |
| <code>+parse(source: String): Number</code>                    | Parses string into a number.                                                                                                                           |
| <code>+getAvailableLocales(): Locale[]</code>                  | Gets the set of locales for which NumberFormats are installed.                                                                                         |

**Figure 35.8**

The `NumberFormat` class provides the methods for formatting and parsing numbers.

With `NumberFormat`, you can format and parse numbers for any locale. Your code will be completely independent of locale conventions for decimal points, thousands-separators, currency format, and percentage formats.

#### 35.4.1 Plain Number Format

You can get an instance of `NumberFormat` for the current locale using `NumberFormat.getInstance()` or `NumberFormat.getNumberInstance` and for the specified locale using `NumberFormat.getInstance(Locale)` or `NumberFormat.getNumberInstance(Locale)`. You can then invoke `format(number)` on the `NumberFormat` instance to return a formatted number as a string.

For example, to display number 5000.555 in France, use the following code:

```
NumberFormat numberFormat = NumberFormat.getInstance(Locale.FRANCE);
System.out.println(numberFormat.format(5000.555));
```

You can control the display of numbers with such methods as `setMaximumFractionDigits` and `setMinimumFractionDigits`. For example, 5000.555 will be displayed as 5000.6 if you use `numberFormat.setMaximumFractionDigits(1)`.

#### 35.4.2 Currency Format

To format a number as a currency value, use `NumberFormat.getCurrencyInstance()` to get the currency number format for the current locale or `NumberFormat.getCurrencyInstance(Locale)` to get the currency number for the specified locale.

For example, to display number `5000.555` as currency in the United States, use the following code:

```
NumberFormat currencyFormat =
 NumberFormat.getCurrencyInstance(Locale.US);
System.out.println(currencyFormat.format(5000.555));
```

5000.555 is formatted into \$5,000.56. If the locale is set to France, the number will be formatted into 5 000,56 €.

#### 35.4.3 Percent Format

To format a number in a percent, use `NumberFormat.getPercentInstance()` or `NumberFormat.getPercentInstance(Locale)` to get the percent number format for the current locale or the specified locale.

For example, to display number 0.555367 as a percent in the United States, use the following code:

```
NumberFormat percentFormat =
 NumberFormat.getPercentInstance(Locale.US);
System.out.println(percentFormat.format(0.555367));
```

0.555367 is formatted into 56%. By default, the format truncates the fraction part in a percent number. If you want to keep three digits after the decimal point, use `percentFormat.setMinimumFractionDigits(3)`. So 0.555367 would be displayed as 55.537%.

#### 35.4.4 Parsing Numbers

You can format a number into a string using the `format(numericalValue)` method. You can also use the `parse(String)` method to convert a formatted plain number, currency value, or percent number with the conventions of a certain locale into an instance of `java.lang.Number`. The `parse` method throws a `java.text.ParseException` if parsing fails. For example, U.S. \$5,000.56 can be parsed into a number using the following statements:

```
NumberFormat currencyFormat =
 NumberFormat.getCurrencyInstance(Locale.US);
try {
 Number number = currencyFormat.parse("$5,000.56");
 System.out.println(number.doubleValue());
}
catch (java.text.ParseException ex) {
 System.out.println("Parse failed");
}
```

#### 35.4.5 The `DecimalFormat` Class

If you want even more control over the format or parsing, cast the `NumberFormat` you get from the factory methods to a `java.text.DecimalFormat`, which is a subclass of `NumberFormat`. You can then use the `applyPattern(String pattern)` method of the `DecimalFormat` class to specify the patterns for displaying the number.

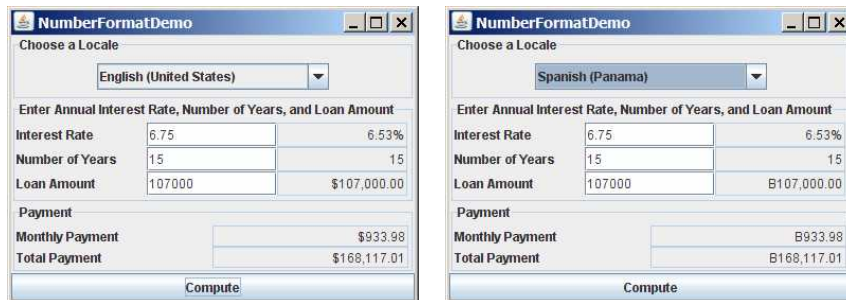
A pattern can specify the minimum number of digits before the decimal point and the maximum number of digits after the decimal point. The characters `'0'` and `'#'` are used to specify a required digit and an optional digit, respectively. The optional digit is not displayed if it is zero. For example, the pattern `"00.0##"` indicates minimum two digits before the decimal point and maximum three digits after the decimal point. If there are more actual digits before the decimal point, all of them are displayed. If there are more than three digits after the decimal point, the number of digits is rounded. Applying the pattern `"00.0##"`, number `111.2226` is formatted to `111.223`, number `1111.2226` to `1111.223`, number `1.22` to `01.22`, and number `1` to `01.0`. Here is the code:

```
NumberFormat numberFormat = NumberFormat.getInstance(Locale.US);
DecimalFormat decimalFormat = (DecimalFormat)numberFormat;
decimalFormat.applyPattern("00.0##");
System.out.println(decimalFormat.format(111.2226));
System.out.println(decimalFormat.format(1111.2226));
System.out.println(decimalFormat.format(1.22));
System.out.println(decimalFormat.format(1));
```

The character `'%'` can be put at the end of a pattern to indicate that a number is formatted as a percentage. This causes the number to be multiplied by `100` and appends a percent sign `%`.

#### 35.4.5 Example: Formatting Numbers

Create a loan calculator for computing loans. The calculator allows the user to choose locales, and displays numbers in accordance with locale-sensitive format. As shown in Figure 35.9, the user enters interest rate, number of years, and loan amount, then clicks the *Compute* button to display the interest rate in percentage format, the number of years in normal number format, and the loan amount, total payment, and monthly payment in currency format. Listing 35.6 gives the solution to the problem.



**Figure 35.9**  
The locale determines the format of the numbers displayed in the loan calculator.

#### Listing 35.6 NumberFormatDemo.java

<margin note line 10: UI components>

```

<margin note line 42: create UI>
<margin note line 99: register listener>
<margin note line 101: new locale>
<margin note line 102: compute loan>
<margin note line 106: register listener>
<margin note line 114: compute loan>
<margin note line 145: main method omitted>
1 import java.awt.*;
2 import java.awt.event.*;
3 import javax.swing.*;
4 import javax.swing.border.*;
5 import java.util.*;
6 import java.text.NumberFormat;
7
8 public class NumberFormatDemo extends JApplet {
9 // Combo box for selecting available locales
10 private JComboBox jcboLocale = new JComboBox();
11
12 // Text fields for interest rate, year, and loan amount
13 private JTextField jtfInterestRate = new JTextField("6.75");
14 private JTextField jtfNumberOfYears = new JTextField("15");
15 private JTextField jtfLoanAmount = new JTextField("107000");
16 private JTextField jtfFormattedInterestRate = new JTextField(10);
17 private JTextField jtfFormattedNumberOfYears = new JTextField(10);
18 private JTextField jtfFormattedLoanAmount = new JTextField(10);
19
20 // Text fields for monthly payment and total payment
21 private JTextField jtfTotalPayment = new JTextField();
22 private JTextField jtfMonthlyPayment = new JTextField();
23
24 // Compute button
25 private JButton jbtCompute = new JButton("Compute");
26
27 // Current locale
28 private Locale locale = Locale.getDefault();
29
30 // Declare locales to store available locales
31 private Locale locales[] = Calendar.getAvailableLocales();
32
33 /** Initialize the combo box */
34 public void initializeComboBox() {
35 // Add locale names to the combo box
36 for (int i = 0; i < locales.length; i++)
37 jcboLocale.addItem(locales[i].getDisplayName());
38 }
39
40 /** Initialize the applet */
41 public void init() {
42 // Panel p1 to hold the combo box for selecting locales
43 JPanel p1 = new JPanel();
44 p1.setLayout(new BorderLayout());
45 p1.add(jcboLocale);
46 initializeComboBox();
47 p1.setBorder(new TitledBorder("Choose a Locale"));
48
49 // Panel p2 to hold the input
50 JPanel p2 = new JPanel();

```

```

51 p2.setLayout(new GridLayout(3, 3));
52 p2.add(new JLabel("Interest Rate"));
53 p2.add(jtfInterestRate);
54 p2.add(jtfFormattedInterestRate);
55 p2.add(new JLabel("Number of Years"));
56 p2.add(jtfNumberOfYears);
57 p2.add(jtfFormattedNumberOfYears);
58 p2.add(new JLabel("Loan Amount"));
59 p2.add(jtfLoanAmount);
60 p2.add(jtfFormattedLoanAmount);
61 p2.setBorder(new TitledBorder("Enter Annual Interest Rate, " +
62 "Number of Years, and Loan Amount"));
63
64 // Panel p3 to hold the result
65 JPanel p3 = new JPanel();
66 p3.setLayout(new GridLayout(2, 2));
67 p3.setBorder(new TitledBorder("Payment"));
68 p3.add(new JLabel("Monthly Payment"));
69 p3.add(jtfMonthlyPayment);
70 p3.add(new JLabel("Total Payment"));
71 p3.add(jtfTotalPayment);
72
73 // Set text field alignment
74 jtfFormattedInterestRate.setHorizontalAlignment(JTextField.RIGHT);
75 jtfFormattedNumberOfYears.setHorizontalAlignment(JTextField.RIGHT);
76 jtfFormattedLoanAmount.setHorizontalAlignment(JTextField.RIGHT);
77 jtfTotalPayment.setHorizontalAlignment(JTextField.RIGHT);
78 jtfMonthlyPayment.setHorizontalAlignment(JTextField.RIGHT);
79
80 // Set editable false
81 jtfFormattedInterestRate.setEditable(false);
82 jtfFormattedNumberOfYears.setEditable(false);
83 jtfFormattedLoanAmount.setEditable(false);
84 jtfTotalPayment.setEditable(false);
85 jtfMonthlyPayment.setEditable(false);
86
87 // Panel p4 to hold result payments and a button
88 JPanel p4 = new JPanel();
89 p4.setLayout(new BorderLayout());
90 p4.add(p3, BorderLayout.CENTER);
91 p4.add(jbtCompute, BorderLayout.SOUTH);
92
93 // Place panels to the applet
94 add(p1, BorderLayout.NORTH);
95 add(p2, BorderLayout.CENTER);
96 add(p4, BorderLayout.SOUTH);
97
98 // Register listeners
99 jcboLocale.addActionListener(new ActionListener() {
100 @Override
101 public void actionPerformed(ActionEvent e) {
102 locale = locales[jcboLocale.getSelectedIndex()];
103 computeLoan();
104 }
105 });
106
107 jbtCompute.addActionListener(new ActionListener() {
108 @Override

```



```

109 public void actionPerformed(ActionEvent e) {
110 computeLoan();
111 }
112 });
113 }
114
115 /** Compute payments and display results locale-sensitive format */
116 private void computeLoan() {
117 // Retrieve input from user
118 double loan = new Double(jtfLoanAmount.getText()).doubleValue();
119 double interestRate =
120 new Double(jtfInterestRate.getText()).doubleValue() / 1200;
121 int numberOfYears =
122 new Integer(jtfNumberOfYears.getText()).intValue();
123
124 // Calculate payments
125 double monthlyPayment = loan * interestRate /
126 (1 - (Math.pow(1 / (1 + interestRate), numberOfYears * 12)));
127 double totalPayment = monthlyPayment * numberOfYears * 12;
128
129 // Get formatters
130 NumberFormat percentFormatter =
131 NumberFormat.getPercentInstance(locale);
132 NumberFormat currencyForm =
133 NumberFormat.getCurrencyInstance(locale);
134 NumberFormat numberForm = NumberFormat.getNumberInstance(locale);
135 percentFormatter.setMinimumFractionDigits(2);
136
137 // Display formatted input
138 jtfFormattedInterestRate.setText(
139 percentFormatter.format(interestRate * 12));
140 jtfFormattedNumberOfYears.setText
141 (numberForm.format(numberOfYears));
142 jtfFormattedLoanAmount.setText(currencyForm.format(loan));
143
144 // Display results in currency format
145 jtfMonthlyPayment.setText(currencyForm.format(monthlyPayment));
146 jtfTotalPayment.setText(currencyForm.format(totalPayment));
147 }
148 }

```

The `computeLoan` method (lines 114-145) gets the input on interest rate, number of years, and loan amount from the user, computes monthly payment and total payment, and displays annual interest rate in percentage format, number of years in normal number format, and loan amount, monthly payment, and total payment in locale-sensitive format.

The statement `percentFormatter.setMinimumFractionDigits(2)` (line 133) sets the minimum number of fractional parts to `2`. Without this statement, `0.075` would be displayed as 7% rather than 7.5%.

### 35.5 Resource Bundles

The `NumberFormatDemo` in the preceding example displays the numbers, currencies, and percentages in local customs, but displays all the message strings, titles, and button labels in English. In this section, you will learn how to use resource bundles to localize message strings, titles, button labels, and so on.

**<margin note: resource bundle>**

A *resource bundle* is a Java class file or text file that provides locale-specific information. This information can be accessed by Java programs dynamically. When a locale-specific resource is needed—a message string, for example—your program can load it from the resource bundle appropriate for the desired locale. In this way, you can write program code that is largely independent of the user's locale, isolating most, if not all, of the locale-specific information in resource bundles.

With resource bundles, you can write programs that separate the locale-sensitive part of your code from the locale-independent part. The programs can easily handle multiple locales, and can easily be modified later to support even more locales.

The resources are placed inside the classes that extend the `ResourceBundle` class or a subclass of `ResourceBundle`. Resource bundles contain *key/value* pairs. Each key uniquely identifies a locale-specific object in the bundle. You can use the key to retrieve the object. `ListResourceBundle` is a convenient subclass of `ResourceBundle` that is often used to simplify the creation of resource bundles. Here is an example of a resource bundle that contains four keys using `ListResourceBundle`:

```
// MyResource.java: resource file
public class MyResource extends java.util.ListResourceBundle {
 static final Object[][] contents = {
 {"nationalFlag", "us.gif"},
 {"nationalAnthem", "us.au"},
 {"nationalColor", Color.red},
 {"annualGrowthRate", new Double(7.8)}
 };

 public Object[][] getContents() {
 return contents;
 }
}
```

Keys are case-sensitive strings. In this example, the keys are `nationalFlag`, `nationalAnthem`, `nationalColor`, and `annualGrowthRate`. The values can be any type of `Object`.

If all the resources are strings, they can be placed in a convenient text file with the extension `.properties`. A typical property file would look like this:

```
#Wed Jul 01 07:23:24 EST 1998
nationalFlag=us.gif
nationalAnthem=us.au
```

To retrieve values from a `ResourceBundle` in a program, you first need to create an instance of `ResourceBundle` using one of the following two static methods:

```
public static final ResourceBundle getBundle(String baseName)
 throws MissingResourceException

public static final ResourceBundle getBundle
 (String baseName, Locale locale) throws MissingResourceException
```

The first method returns a `ResourceBundle` for the default locale, and the second method returns a `ResourceBundle` for the specified locale. `baseName` is the base name for a set of classes, each of which describes the information for a given locale. These classes are named in Table 35.3.

Table 35.3:

*Resource Bundle Naming Conventions*

1. `BaseName_language_country_variant.class`
2. `BaseName_language_country.class`
3. `BaseName_language.class`
4. `BaseName.class`
5. `BaseName_language_country_variant.properties`
6. `BaseName_language_country.properties`
7. `BaseName_language.properties`
8. `BaseName.properties`

For example, `MyResource_en_BR.class` stores resources specific to the United Kingdom, `MyResource_en_US.class` stores resources specific to the United States, and `MyResource_en.class` stores resources specific to all the English-speaking countries.

The `getBundle` method attempts to load the class that matches the specified locale by language, country, and variant by searching the file names in the order shown in Table 35.3. The files searched in this order form a *resource chain*. If no file is found in the resource chain, the `getBundle` method raises a `MissingResourceException`, a subclass of `RuntimeException`.

Once a resource bundle object is created, you can use the `getObject` method to retrieve the value according to the key. For example,

```
ResourceBundle res = ResourceBundle.getBundle("MyResource");
String flagFile = (String)res.getObject("nationalFlag");
String anthemFile = (String)res.getObject("nationalAnthem");
Color color = (Color)res.getObject("nationalColor");
double growthRate = (Double)res.getObject("annualGrowthRate");
```

**TIP**

If the resource value is a string, the convenient `getString` method can be used to replace the `getObject` method. The `getString` method simply casts the value returned by `getObject` to a string.

What happens if a resource object you are looking for is not defined in the resource bundle? Java employs an intelligent look-up scheme that searches the object in the parent file along the resource chain. This search is repeated until the object is found or all the parent files in the resource chain have been searched. A `MissingResourceException` is raised if the search is unsuccessful.

Let us modify the `NumberFormatDemo` program in the preceding example so that it displays messages, title, and button labels in multiple languages, as shown in Figure 35.10.



**Figure 35.10**

*The program displays the strings in multiple languages.*

You need to provide a resource bundle for each language. Suppose the program supports three languages: English (default), Chinese, and French. The resource bundle for the English language, named `MyResource.properties`, is given as follows:

```
#MyResource.properties for English language
Number_Of_Years=Years
Total_Payment=French Total\ Payment
Enter_Interest_Rate=Enter\ Interest\ Rate,\ Years,\ and\ Loan\ Amount
Payment=Payment
Compute=Compute
Annual_Interest_Rate=Interest\ Rate
Number_Formatting=Number\ Formatting\ Demo
Loan_Amount=Loan\ Amount
Choose_a_Locale=Choose\ a\ Locale
Monthly_Payment=Monthly\ Payment
```

The resource bundle for the Chinese language, named `MyResource_zh.properties`, is given as follows:

```
#MyResource_zh.properties for Chinese language
Choose_a_Locale = \u9078\u64c7\u570b\u55bb6
Enter_Interest_Rate =
 \u8f38\u5165\u5229\u7387,\u5e74\u9650,\u8cb8\u6b3e\u7e3d\u984d
Annual_Interest_Rate = \u5229\u7387
Number_Of_Years = \u5e74\u9650
Loan_Amount = \u8cb8\u6b3e\u984d\u5ea6
Payment = \u4ed8\u606f
Monthly_Payment = \u6708\u4ed8
Total_Payment = \u7e3d\u984d
Compute = \u8a08\u7b97\u8cb8\u6b3e\u5229\u606f
```

The resource bundle for the French language, named `MyResource_fr.properties`, is given as follows:

```
#MyResource_fr.properties for French language
Number_Of_Years=annees
Annual_Interest_Rate=le taux d'interet
Loan_Amount=Le montant du pret
Enter_Interest_Rate=inscrire le taux d'interet, les annees, et le montant du
pret
Payment=paiement
Compute=Calculer l'hypothèque
```

Number\_Formatting=demonstration du formatting des chiffres  
 Choose\_a\_Locale=Choisir la localite  
 Monthly\_Payment=versement mensuel  
 Total\_Payment=reglement total

The resource-bundle file should be placed in the class directory (e.g.,  
**c:\book** for the examples in this book). The program is given in Listing 35.7.

**Listing 35.7 ResourceBundleDemo.java**

```

<margin note line 11: get resource>
<margin note line 61: create UI>
<margin note line 120: register listener>
<margin note line 123: update resource>
<margin note line 128: register listener>
<margin note line 169: new resource>
<margin note line 192: res in applet>

1 import java.awt.*;
2 import java.awt.event.*;
3 import javax.swing.*;
4 import javax.swing.border.*;
5 import java.util.*;
6 import java.text.NumberFormat;
7
8 public class ResourceBundleDemo extends JApplet {
9 // Combo box for selecting available locales
10 private JComboBox jcboLocale = new JComboBox();
11 private ResourceBundle res = ResourceBundle.getBundle("MyResource");
12
13 // Create labels
14 private JLabel jlblInterestRate =
15 new JLabel(res.getString("Annual_Interest_Rate"));
16 private JLabel jlblNumberOfYears =
17 new JLabel(res.getString("Number_Of_Years"));
18 private JLabel jlblLoanAmount =
19 new JLabel(res.getString("Loan_Amount"));
20 private JLabel jlblMonthlyPayment =
21 new JLabel(res.getString("Monthly_Payment"));
22 private JLabel jlblTotalPayment =
23 new JLabel(res.getString("Total_Payment"));
24
25 // Create titled borders
26 private TitledBorder comboBoxTitle =
27 new TitledBorder(res.getString("Choose_a_Locale"));
28 private TitledBorder inputTitle = new TitledBorder
29 (res.getString("Enter_Interest_Rate"));
30 private TitledBorder paymentTitle =
31 new TitledBorder(res.getString("Payment"));
32
33 // Text fields for interest rate, year, loan amount,
34 private JTextField jtfInterestRate = new JTextField("6.75");
35 private JTextField jtfNumberOfYears = new JTextField("15");
36 private JTextField jtfLoanAmount = new JTextField("107000");
37 private JTextField jtfFormattedInterestRate = new JTextField(10);
38 private JTextField jtfFormattedNumberOfYears = new JTextField(10);
39 private JTextField jtfFormattedLoanAmount = new JTextField(10);
40

```

```

41 // Text fields for monthly payment and total payment
42 private JTextField jtfTotalPayment = new JTextField();
43 private JTextField jtfMonthlyPayment = new JTextField();
44
45 // Compute button
46 private JButton jbtCompute = new JButton(res.getString("Compute"));
47
48 // Current locale
49 private Locale locale = Locale.getDefault();
50
51 // Declare locales to store available locales
52 private Locale locales[] = Calendar.getAvailableLocales();
53
54 /** Initialize the combo box */
55 public void initializeComboBox() {
56 // Add locale names to the combo box
57 for (int i = 0; i < locales.length; i++)
58 jcboLocale.addItem(locales[i].getDisplayName());
59 }
60
61 /** Initialize the applet */
62 public void init() {
63 // Panel p1 to hold the combo box for selecting locales
64 JPanel p1 = new JPanel();
65 p1.setLayout(new FlowLayout());
66 p1.add(jcboLocale);
67 initializeComboBox();
68 p1.setBorder(comboBoxTitle);
69
70 // Panel p2 to hold the input for annual interest rate,
71 // number of years and loan amount
72 JPanel p2 = new JPanel();
73 p2.setLayout(new GridLayout(3, 3));
74 p2.add(jlblInterestRate);
75 p2.add(jtfInterestRate);
76 p2.add(jtfFormattedInterestRate);
77 p2.add(jlblNumberOfYears);
78 p2.add(jtfNumberOfYears);
79 p2.add(jtfFormattedNumberOfYears);
80 p2.add(jlblLoanAmount);
81 p2.add(jtfLoanAmount);
82 p2.add(jtfFormattedLoanAmount);
83 p2.setBorder(inputTitle);
84
85 // Panel p3 to hold the payment
86 JPanel p3 = new JPanel();
87 p3.setLayout(new GridLayout(2, 2));
88 p3.setBorder(paymentTitle);
89 p3.add(jlblMonthlyPayment);
90 p3.add(jtfMonthlyPayment);
91 p3.add(jlblTotalPayment);
92 p3.add(jtfTotalPayment);
93
94 // Set text field alignment
95 jtfFormattedInterestRate.setHorizontalAlignment
96 (JTextField.RIGHT);
97 jtfFormattedNumberOfYears.setHorizontalAlignment
98 (JTextField.RIGHT);

```

```

99 jtfFormattedLoanAmount.setHorizontalAlignment(JTextField.RIGHT);
100 jtfTotalPayment.setHorizontalAlignment(JTextField.RIGHT);
101 jtfMonthlyPayment.setHorizontalAlignment(JTextField.RIGHT);
102
103 // Set editable false
104 jtfFormattedInterestRate.setEditable(false);
105 jtfFormattedNumberOfYears.setEditable(false);
106 jtfFormattedLoanAmount.setEditable(false);
107 jtfTotalPayment.setEditable(false);
108 jtfMonthlyPayment.setEditable(false);
109
110 // Panel p4 to hold result payments and a button
111 JPanel p4 = new JPanel();
112 p4.setLayout(new BorderLayout());
113 p4.add(p3, BorderLayout.CENTER);
114 p4.add(jbtCompute, BorderLayout.SOUTH);
115
116 // Place panels to the applet
117 add(p1, BorderLayout.NORTH);
118 add(p2, BorderLayout.CENTER);
119 add(p4, BorderLayout.SOUTH);
120
121 // Register listeners
122 jcboLocale.addActionListener(new ActionListener() {
123 @Override
124 public void actionPerformed(ActionEvent e) {
125 locale = locales[jcboLocale.getSelectedIndex()];
126 updateStrings();
127 computeLoan();
128 }
129 });
130
131 jbtCompute.addActionListener(new ActionListener() {
132 @Override
133 public void actionPerformed(ActionEvent e) {
134 computeLoan();
135 }
136 });
137 }
138
139 /** Compute payments and display results locale-sensitive format */
140 private void computeLoan() {
141 // Retrieve input from user
142 double loan = new Double(jtfLoanAmount.getText()).doubleValue();
143 double interestRate =
144 new Double(jtfInterestRate.getText()).doubleValue() / 1200;
145 int numberOfYears =
146 new Integer(jtfNumberOfYears.getText()).intValue();
147
148 // Calculate payments
149 double monthlyPayment = loan * interestRate /
150 (1 - (Math.pow(1 / (1 + interestRate), numberOfYears * 12)));
151 double totalPayment = monthlyPayment * numberOfYears * 12;
152
153 // Get formatters
154 NumberFormat percentFormatter =
155 NumberFormat.getPercentInstance(locale);
156 NumberFormat currencyForm =

```

```

157 NumberFormat.getCurrencyInstance(locale);
158 NumberFormat numberForm = NumberFormat.getNumberInstance(locale);
159 percentFormatter.setMinimumFractionDigits(2);
160
161 // Display formatted input
162 jtfFormattedInterestRate.setText(
163 percentFormatter.format(interestRate * 12));
164 jtfFormattedNumberOfYears.setText
165 (numberForm.format(numberOfYears));
166 jtfFormattedLoanAmount.setText(currencyForm.format(loan));
167
168 // Display results in currency format
169 jtfMonthlyPayment.setText(currencyForm.format(monthlyPayment));
170 jtfTotalPayment.setText(currencyForm.format(totalPayment));
171 }
172
173 /** Update resource strings */
174 private void updateStrings() {
175 res = ResourceBundle.getBundle("MyResource", locale);
176 jlblInterestRate.setText(res.getString("Annual_Interest_Rate"));
177 jlblNumberOfYears.setText(res.getString("Number_Of_Years"));
178 jlblLoanAmount.setText(res.getString("Loan_Amount"));
179 jlblTotalPayment.setText(res.getString("Total_Payment"));
180 jlblMonthlyPayment.setText(res.getString("Monthly_Payment"));
181 jbtCompute.setText(res.getString("Compute"));
182 comboBoxTitle.setTitle(res.getString("Choose_a_Locale"));
183 inputTitle.setTitle(res.getString("Enter_Interest_Rate"));
184 paymentTitle.setTitle(res.getString("Payment"));
185
186 // Make sure the new labels are displayed
187 repaint();
188 }
189
190 /** Main method */
191 public static void main(String[] args) {
192 // Create an instance of the applet
193 ResourceBundleDemo applet = new ResourceBundleDemo();
194
195 // Create a frame with a resource string
196 JFrame frame = new JFrame(
197 applet.res.getString("Number_Formatting"));
198
199 // Add the applet instance to the frame
200 frame.add(applet, BorderLayout.CENTER);
201
202 // Invoke init() and start()
203 applet.init();
204 applet.start();
205
206 // Display the frame
207 frame.setSize(400, 300);
208 frame.setLocationRelativeTo(null);
209 frame.setDefaultCloseOperation(JFrame.EXIT_ON_CLOSE);
210 frame.setVisible(true);
211 }
212 }

```

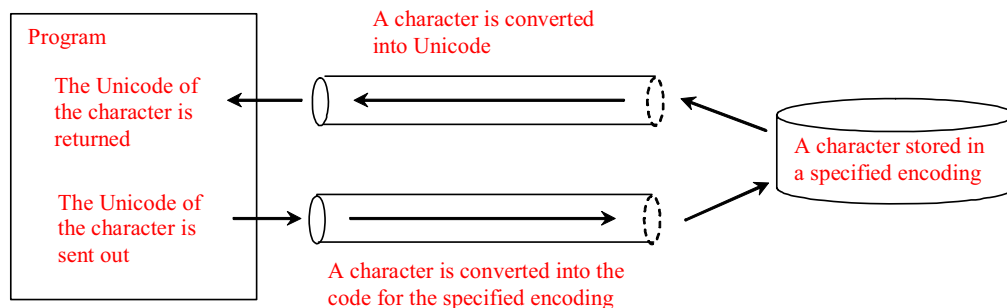


Property resource bundles are implemented as text files with a `.properties` extension, and are placed in the same location as the class files for the application or applet. `ListResourceBundles` are provided as Java class files. Because they are implemented using Java source code, new and modified `ListResourceBundles` need to be recompiled for deployment. With `PropertyResourceBundles`, there is no need for recompilation when translations are modified or added to the application. Nevertheless, `ListResourceBundles` provide considerably better performance than `PropertyResourceBundles`. If the resource bundle is not found or a resource object is not found in the resource bundle, a `MissingResourceException` is raised. Since `MissingResourceException` is a subclass of `RuntimeException`, you do not need to catch the exception explicitly in the code.

This example is the same as Listing 35.6, `NumberFormatDemo.java`, except that the program contains the code for handling resource strings. The `updateString` method (lines 172-186) is responsible for displaying the locale-sensitive strings. This method is invoked when a new locale is selected in the combo box. Since the variable `res` of the `ResourceBundle` class is an instance variable in `ResourceBundleDemo`, it cannot be directly used in the `main` method, because the `main` method is static. To fix the problem, create `applet` as an instance of `ResourceBundleDemo`, and you will then be able to reference `res` using `applet.res`.

### 35.6 Character Encoding

Java programs use Unicode. When you read a character using text I/O, the Unicode code of the character is returned. The encoding of the character in the file may be different from the Unicode encoding. Java automatically converts it to the Unicode. When you write a character using text I/O, Java automatically converts the Unicode of the character to the encoding specified for the file. This is pictured in Figure 35.11.



**Figure 35.11**

*The encoding of the file may be different from the encoding used in the program.*

You can specify an encoding scheme using a constructor of `Scanner/PrintWriter` for text I/O, as follows:

```
public Scanner(File file, String encodingName)
public PrintWriter(File file, String encodingName)
```

For a list of encoding schemes supported in Java, see <http://download.oracle.com/javase/1.5.0/docs/guide/intl/encoding.doc.html> and [mindprod.com/jgloss/encoding.html](http://mindprod.com/jgloss/encoding.html). For example, you may use the encoding name `GB18030` for simplified Chinese characters, `Big5` for traditional Chinese

characters, [Cp939](#) for Japanese characters, [Cp933](#) for Korean characters, and [Cp838](#) for Thai characters.

The following code in Listing 35.8 creates a file using the GB18030 encoding (line 8). You have to read the text using the same encoding (line 12). The output is shown in Figure 35.12a.

**Listing 35.8 EncodingDemo.java**

*<margin note line 8: specify encoding>*  
*<margin note line 12: specify encoding>*

```
1 import java.util.*;
2 import java.io.*;
3 import javax.swing.*;
4
5 public class EncodingDemo {
6 public static void main(String[] args)
7 throws IOException, FileNotFoundException {
8 PrintWriter output = new PrintWriter("temp.txt", "GB18030");
9 output.print("\u6B22\u8FCE Welcome \u03b1\u03b2\u03b3");
10 output.close();
11
12 Scanner input = new Scanner(new File("temp.txt"), "GB18030");
13 JOptionPane.showMessageDialog(null, input.nextLine());
14 }
15 }
```



(a) Using GB18030 encoding



(b) Using default encoding

**Figure 35.12**

You can specify an encoding scheme for a text file.

If you don't specify an encoding in lines 8 and 12, the system's default encoding scheme is used. The US default encoding is ASCII. ASCII code uses 8 bits. Java uses the 16-bit Unicode. If a Unicode is not an ASCII code, the character '?' is written to the file. Thus, when you write `\u6B22` to an ASCII file, the ? character is written to the file. When you read it back, you will see the ? character, as shown in Figure 35.12b.

To find out the default encoding on your system, use

*<margin note line 8: get default encoding>*

```
System.out.println(System.getProperty("file.encoding"));
```

The default encoding name is [Cp1252](#) on Windows, which is a variation of ASCII.

Key Terms

- locale 7
- resource bundle
- file encoding scheme

## Chapter Summary

1. Java is the first language designed from the ground up to support internationalization. In consequence, it allows your programs to be customized for any number of countries or languages without requiring cumbersome changes in the code.
2. Java characters use *Unicode* in the program. The use of Unicode encoding makes it easy to write Java programs that can manipulate strings in any international language.
3. Java provides the *Locale* class to encapsulate information about a specific locale. A *Locale* object determines how locale-sensitive information, such as date, time, and number, is displayed, and how locale-sensitive operations, such as sorting strings, are performed. The classes for formatting date, time, and numbers, and for sorting strings are grouped in the *java.text* package.
4. Different locales have different conventions for displaying date and time. The *java.text.DateFormat* class and its subclasses can be used to format date and time in a locale-sensitive way for display to the user.
5. To format a number for the default or a specified locale, use one of the factory class methods in the *NumberFormat* class to get a formatter. Use *getInstance* or *getNumberInstance* to get the normal number format. Use *getCurrencyInstance* to get the currency number format. Use *getPercentInstance* to get a format for displaying percentages.
6. Java uses the *ResourceBundle* class to separate locale-specific information, such as status messages and GUI component labels, from the program. The information is stored outside the source code and can be accessed and loaded dynamically at runtime from a *ResourceBundle*, rather than hard-coded into the program.
7. You can specify an encoding for a text file when constructing a *PrintWriter* or a *Scanner*.

## Test Questions

Do the test questions for this chapter online at  
[www.cs.armstrong.edu/liang/intro9e/test.html](http://www.cs.armstrong.edu/liang/intro9e/test.html).

## Review Questions

### Sections 35.1-35.2

35.1

How does Java support international characters in languages like Chinese and Arabic?

35.2

How do you construct a *Locale* object? How do you get all the available locales from a *Calendar* object?

35.3

How do you set a locale for the French-speaking region of Canada in a Swing *JButton*? How do you set a locale for the Netherlands in a Swing *JLabel*?

### Section 35.3

35.4

How do you set the time zone "PST" for a *Calendar* object?

35.5

How do you display current date and time in German?

35.6

How do you use the *SimpleDateFormat* class to display date and time using the pattern "yyyy.MM.dd hh:mm:ss"?

35.7

In line 73 of `WorldClockControl.java`, `Arrays.sort(availableTimeZones)` is used to sort the available time zones. What happens if you attempt to sort the available locales using `Arrays.sort(availableLocales)`?

#### Section 35.4

35.8

Write the code to format number 12345.678 in the United Kingdom locale. Keep two digits after the decimal point.

35.9

Write the code to format number 12345.678 in U.S. currency.

35.10

Write the code to format number 0.345678 as percentage with at least three digits after the decimal point.

35.11

Write the code to parse 3,456.78 into a number.

35.12

Write the code that uses the `DecimalFormat` class to format number 12345.678 using the pattern "0.0000#".

#### Section 35.5

35.13

How does the `getBundle` method locate a resource bundle?

35.14

How does the `getObject` method locate a resource?

#### Section 35.6

35.15

How do you specify an encoding scheme for a text file?

35.16

What would happen if you wrote a Unicode character to an ASCII text file?

35.17

How do you find the default encoding name on your system?

### Programming Exercises

#### Sections 35.1-35.2

35.1\*

(Unicode viewer) Develop an applet that displays Unicode characters, as shown in Figure 35.13. The user specifies a Unicode in the text field and presses the `Enter` key to display a sequence of Unicode characters starting with the specified Unicode. The Unicode characters are displayed in a scrollable text area of 20 lines. Each line contains 16 characters preceded by the Unicode that is the code for the first character on the line.



**Figure 35.13**

The applet displays the Unicode characters.

35.2\*\*

(Display date and time) Write a program that displays the current date and time as shown in Figure 35.14. The program enables the user to select a locale, time zone, date style, and time style from the combo boxes.



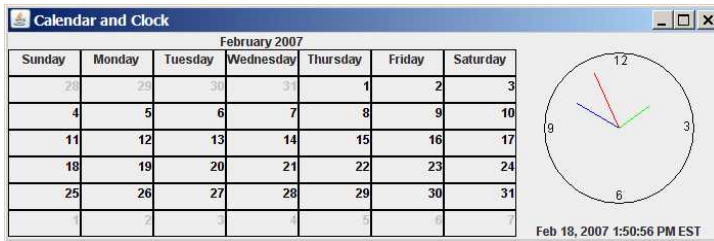
**Figure 35.14**

The program displays the current date and time.

### Section 35.3

35.3

(Place the calendar and clock in a panel) Write an applet that displays the current date in a calendar and current time in a clock, as shown in Figure 35.15. Enable the applet to run standalone.

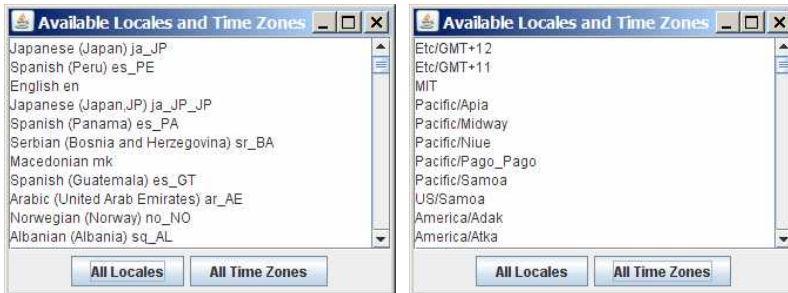


**Figure 35.15**

The calendar and clock display the current date and time.

35.4

(Find the available locales and time zone IDs) Write two programs to display the available locales and time zone IDs using buttons, as shown in Figure 35.16.



**Figure 35.16**

The program displays available locales and time zones using buttons.

### Section 35.4

35.5\*

(Compute loan amortization schedule) Rewrite Exercise 4.22 using an applet, as shown in Figure 35.17. The applet allows the user to set the loan amount, loan period, and interest rate, and displays the corresponding interest, principal, and balance in the currency format.

| Payment# | Interest | Principal | Balance    |
|----------|----------|-----------|------------|
| 1        | \$58.33  | \$806.93  | \$9,193.07 |
| 2        | \$53.63  | \$811.64  | \$8,381.42 |
| 3        | \$48.89  | \$816.38  | \$7,565.05 |
| 4        | \$44.13  | \$821.14  | \$6,743.91 |
| 5        | \$39.34  | \$825.93  | \$5,917.98 |
| 6        | \$34.52  | \$830.75  | \$5,087.24 |

**Figure 35.17**

The program displays the loan payment schedule.

35.6

(Convert dollars to other currencies) Write a program that converts U.S. dollars to Canadian dollars, German marks, and British pounds, as shown in Figure 35.18. The user enters the U.S. dollar amount and the conversion rate, and clicks the *Convert* button to display the converted amount.

|                  | Exchange Rate | Converted Amount |
|------------------|---------------|------------------|
| Canadian Dollars | 1.5           | \$3,000.00       |
| German Marks     | 1.4           | ≈ 2,800.00       |
| British Pounds   | 0.5           | £1,000.00        |

**Figure 35.18**

The program converts U.S. dollars to Canadian dollars, German marks, and British pounds.

35.7

(Compute loan payments) Rewrite Listing 2.8, `ComputeLoan.java`, to display the monthly payment and total payment in currency.

35.8

(Use the `DecimalFormat` class) Rewrite Exercise 5.8 to display at most two digits after the decimal point for the temperature using the `DecimalFormat` class.

### Section 35.5

35.9\*

(Use resource bundle) Modify the example for displaying a calendar in §35.3.6, "Example: Displaying a Calendar," to localize the labels "Choose a locale" and "Calendar Demo" in French, German, Chinese, or a language of your choice.

35.10\*\*

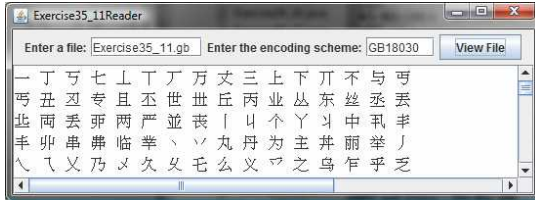
(Flag and anthem) Rewrite Listing 18.13, `ImageAudioAnimation.java`, to use the resource bundle to retrieve image and audio files.

(Hint: When a new country is selected, set an appropriate locale for it. Have your program look for the flag and audio file from the resource file for the locale.)

### Section 35.6

35.11\*\*

(Specify file encodings) Write a program named Exercise35\_11Writer that writes 1307 × 16 Chinese Unicode characters starting from `\u0E00` to a file named Exercise35\_11.gb using the GBK encoding scheme. Output 16 characters per line and separate the characters with spaces. Write a program named Exercise35\_11Reader that reads all the characters from a file using a specified encoding. Figure 35.19 displays the file using the GBK encoding scheme.



**Figure 35.19**

The program displays the file using the specified encoding scheme.

*\*\*\*This is a bonus Web chapter*

## **CHAPTER 36**

### **JavaBeans**

#### **Objectives**

- To describe what a JavaBeans component is (§36.2).
- To explain the similarities and differences between beans and regular objects (§36.2).
- To develop JavaBeans components that follow the naming patterns (§36.3).
- To review the Java event delegation model (§36.4).
- To create custom event classes and listener interfaces (§36.5).
- To develop source components using event sets from the Java API or custom event sets (§36.6).



### 36.1 Introduction

Every Java user interface class is a JavaBeans component. Understanding JavaBeans will help you to learn GUI components. In Chapter 16, “Event-Driven Programming,” you learned how to handle events fired from source components such as `JButton`, `JTextField`, `JRadioButton`, and `JComboBox`. In this chapter, you will learn how to create custom events and develop your own source components that can fire events. By developing your own events and source components, you will gain a better understanding of the Java event model and GUI components.

### 36.2 JavaBeans

*<margin note: JavaBeans>*

JavaBeans is a software component architecture that extends the power of the Java language by enabling well-formed objects to be manipulated visually at design time in a pure Java builder tool, such as NetBeans and Eclipse. Such well-formed objects are referred to as *JavaBeans* or simply *beans*. The classes that define the beans, referred to as *JavaBeans components* or *bean components*, conform to the JavaBeans component model with the following requirements:

- A bean must be a public class.
- A bean must have a public no-arg constructor, though it can have other constructors if needed. For example, a bean named `MyBean` must either have a constructor with the signature

```
public MyBean();
```

or have no constructor if its superclass has a no-arg constructor.

*<margin note: Serializable>*

- A bean must implement the `java.io.Serializable` interface to ensure a persistent state.

*<margin note: accessor>*

*<margin note: mutator>*

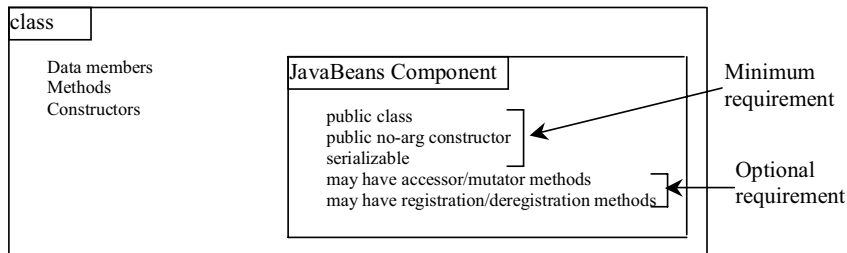
- A bean usually has properties with correctly constructed public accessor (get) methods and mutator (set) methods that enable the properties to be seen and updated visually by a builder tool.

*<margin note: event registration>*

- A bean may have events with correctly constructed public registration and deregistration methods that enable it to add and remove listeners. If the bean plays a role as the source of events, it must provide registration methods for registering listeners. For example, you can register a listener for `ActionEvent` using the `addActionListener` method of a `JButton` bean.

The first three requirements must be observed, and therefore are referred to as *minimum JavaBeans component requirements*. The last two requirements depend on implementations. It is possible to write a bean component without get/set methods and event registration/deregistration methods.

A JavaBeans component is a special kind of Java class. The relationship between JavaBeans components and Java classes is illustrated in Figure 36.1.



**Figure 36.1**

A *JavaBeans component* is a serializable public class with a public no-arg constructor.

Every GUI class is a JavaBeans component, because

- (1) it is a public class,
- (2) it has a public no-arg constructor, and
- (3) It is an extension of `java.awt.Component`, which implements `java.io.Serializable`.

### 36.3 Bean Properties

Properties are discrete, named attributes of a Java bean that can affect its appearance or behavior. They are often data fields of a bean. For example, the `JButton` component has a property named `text` that represents the text to be displayed on the button. Private data fields are often used to hide specific implementations from the user and prevent the user from accidentally corrupting the properties. Accessor and mutator methods are provided instead to let the user read and write the properties.

#### 36.3.1 Property-Naming Patterns

The bean property-naming pattern is a convention of the JavaBeans component model that simplifies the bean developer's task of presenting properties. A property can be a primitive data type or an object type. The property type dictates the signature of the accessor and mutator methods.

In general, the accessor method is named `get<PropertyName>()`, which takes no parameters and returns a primitive type value or an object of a type identical to the property type. For example,

```
<margin note: accessor method>
public String getMessage()
public int getXCoordinate()
public int getYCoordinate()
```

For a property of `boolean` type, the accessor method should be named `is<PropertyName>()`, which returns a `boolean` value. For example,

```
<margin note: boolean accessor method>
public boolean isCentered()
```

The mutator method should be named `set<PropertyName>(dataType p)`, which takes a single parameter identical to the property type and returns `void`. For example,

```
<margin note: mutator method>
```

```
public void setMessage(String s)
public void setXCoordinate(int x)
public void setYCoordinate(int y)
public void setCentered(boolean centered)
```

NOTE

You may have multiple get and set methods, but there must be one get or set method with a signature conforming to the naming patterns.

### 36.3.2 Properties and Data Fields

Properties describe the state of the bean. Naturally, data fields are used to store properties. However, a bean property is not necessarily a data field. For example, in the `MessagePanel` class in Listing 15.7, `MessagePanel.java`, you may create a new property named `messageLength` that represents the number of characters in `message`. The get method for the property may be defined as follows:

```
public int getMessageLength() {
 return message.length();
}
```

NOTE

<margin note: read-only property>

<margin note: write-only property>

A property may be *read-only* with a get method but no set method, or *write-only* with a set method but no get method.

### 36.4 Java Event Model Review

A bean may communicate with other beans. The Java event delegation model provides the foundation for beans to send, receive, and handle events. Let us review the Java event model that was introduced in Chapter 16, "Event-Driven Programming." The Java event model consists of the following three types of elements, as shown in Figure 16.3:

- The event object
- The source object
- The event listener object

<margin note: event>

<margin note: source object>

<margin note: listener>

An event is a signal to the program that something has happened. It can be triggered by external user actions, such as mouse movements, mouse button clicks, and keystrokes, or by the operating system, such as a timer. An *event object* contains the information that describes the event. A *source object* is where the event originates. When an event occurs on a source object, an event object is created. An object interested in the event handles the event. Such an object is called a *listener*. Not all objects can handle events. To become a listener, an object must be registered as a listener by the source object. The source object maintains a list of listeners and notifies all the registered listeners by invoking the event-handling method implemented on the listener object. The handlers are defined in *event listener interface*. Each event class has a corresponding event listener interface. The Java event model is referred to as a *delegation-based model*, because the source object delegates the event to the listeners for processing.

### 36.4.1 Event Classes and Event Listener Interfaces

An event object is created using an event class, such as `ActionEvent`, `MouseEvent`, and `ItemEvent`, as shown in Figure 16.2. All the event classes extend `java.util.EventObject`. The event class contains whatever data values and methods are pertinent to the particular event type. For example, the `KeyEvent` class describes the data values related to a key event and contains the methods, such as `getKeyChar()`, for retrieving the key associated with the event.

#### <margin note: handler>

Every event class is associated with an event listener interface that defines one or more methods referred to as *handlers*. An event listener interface is a subinterface of `java.util.EventListener`. The handlers are implemented by the listener components. The source component invokes the listeners' handlers when an event is detected.

#### <margin note: event set>

Since an event class and its listener interface are coexistent, they are often referred to as an *event set* or *event pair*. The event listener interface must be named as *XListener* for the *XEvent*. For example, the listener interface for `ActionEvent` is `ActionListener`. The parameter list of a handler always consists of an argument of the event class type. Table 16.2 lists some commonly used events and their listener interfaces. Figure 36.2 shows the pair of `ActionEvent` and `ActionListener`.

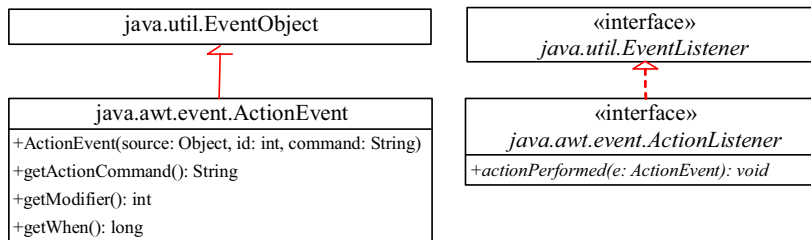


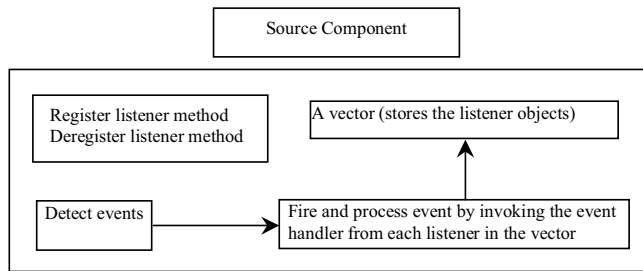
Figure 36.2

`ActionEvent` and `ActionListener` are examples of an event pair.

### 36.4.2 Source Components

The component on which an event is generated is referred to as an *event source*. Every Java GUI component is an *event source* for one or more events. For example, `JButton` is an event source for `ActionEvent`. A `JButton` object fires a `java.awt.event.ActionEvent` when it is clicked. `JComboBox` is an event source for `ActionEvent` and `ItemEvent`. A `JComboBox` object fires a `java.awt.event.ActionEvent` and a `java.awt.event.ItemEvent` when a new item is selected in the combo box.

The source component contains the code that detects an external or internal action that triggers the event. Upon detecting the action, the source should fire an event to the listeners by invoking the event handler defined by the listeners. The source component must also contain methods for registering and deregistering listeners, as shown in Figure 36.3.



**Figure 36.3**

The source component detects events and processes them by invoking the event listeners' handlers.

### 36.4.3 Listener Components

A listener component for an event must implement the event listener interface. The object of the listener component cannot receive event notifications from a source component unless the object is registered as a listener of the source.

A listener component may implement any number of listener interfaces to listen to several types of events. A source component may register many listeners. A source component may register itself as a listener.

Listing 36.1 gives an example that creates a source object (line 8) and a listener object (line 14), and registers the listener with the source object (line 17). Figure 36.4 highlights the relationship between the source and the listener. The listener is registered with the source by invoking the `addActionListener` method. Once the button is clicked, an `ActionEvent` is generated by the source. The source object then notifies the listener by invoking the listener's `actionPerformed` method.

**Listing 36.1 TestSourceListener.java**

```

<margin note line 8: source object>
<margin note line 14: listener object>
<margin note line 17: registration>
<margin note line 22: listener class>

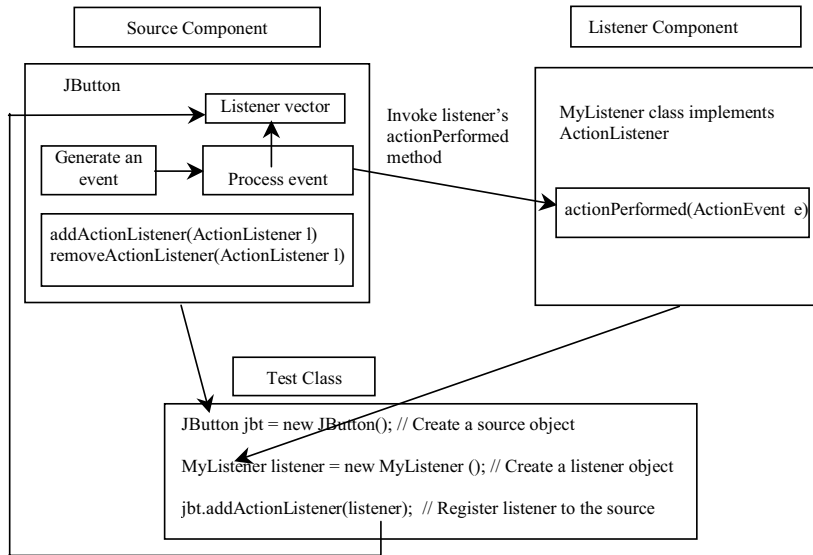
1 import javax.swing.*;
2 import java.awt.event.*;
3
4 public class TestSourceListener {
5 public static void main(String[] args) {
6 JFrame frame = new JFrame("TestSourceListener");
7 // Create a source object
8 JButton jbt = new JButton("OK");
9 frame.add(jbt);
10 frame.setSize(200, 200);
11 frame.setVisible(true);
12
13 // Create a listener
14 MyListener listener = new MyListener();
15
16 // Register a listener
17 jbt.addActionListener(listener);
18 }
19 }
20

```

```

21 /** MyListener class */
22 class MyListener implements ActionListener {
23 @Override
24 public void actionPerformed(ActionEvent e) {
25 System.out.println("I will process it!");
26 }
27 }

```



**Figure 36.4**

The listener is registered with the source, and the source invokes the listener's handler to process the event.

### 36.5 Creating Custom Source Components

You have used source components such as `JButton`. This section demonstrates how to create a custom source component.

#### <margin note: registration method>

A source component must have the appropriate registration and deregistration methods for adding and removing listeners. Events can be unicasted (only one listener object is notified of the event) or multicasted (each object in a list of listeners is notified of the event). The naming pattern for adding a unicast listener is

#### <margin note: unicast>

```

public void add<Event>Listener(<Event>Listener l)
 throws TooManyListenersException;

```

The naming pattern for adding a multicast listener is the same, except that it does not throw the `TooManyListenersException`.

#### <margin note: multicast>

```

public void add<Event>Listener(<Event>Listener l)

```

#### <margin note: deregistration method>

The naming pattern for removing a listener (either unicast or multicast) is:

```
public void remove<Event>Listener (<Event>Listener l)
```

A source component contains the code that creates an event object and passes it to invoke the handler of the listeners. You may use a standard Java event class like `ActionEvent` to create event objects or may define your own event classes if necessary.

The `Course` class in Section 10.8, "Case Study: Designing the `Course` Class," models the courses. Suppose a `Course` object fires an `ActionEvent` when the number of students for the course exceeds a certain enrollment cap. The new class named `CourseWithActionEvent` is shown in Figure 36.5.

CourseWithActionEvent	
-courseName: String	The name of the course.
-students: ArrayList<String>	The students who take the course.
-enrollmentCap: int	The maximum enrollment (default: 10).
+CourseWithActionEvent()	Creates a default course.
+CourseWithActionEvent(courseName: String)	Creates a course with the specified name.
+getCourseName(): String	Returns the course name.
+addStudent(student: String): void	Adds a new student to the course list.
+getStudents(): ArrayList<String>	Returns the students for the course as an array.
+getNumberOfStudents(): int	Returns the number of students for the course.
+getEnrollmentCap(): int	Returns the enrollment cap.
+setEnrollmentCap(enrollmentCap: int): void	Sets a new enrollment cap.
+addActionListener(e: ActionEvent): void	Adds a new ActionEvent listener.
+removeActionListener(e: ActionEvent): void	Deletes an ActionEvent listener.
-processEvent(e: ActionEvent): void	Processes an ActionEvent.

**Figure 36.5**

The new `CourseWithActionEvent` class can fire an `ActionEvent`.

The source component is responsible for registering listeners, creating events, and notifying listeners by invoking the methods defined in the listeners' interfaces. The `CourseWithActionEvent` component is capable of registering multiple listeners, generating `ActionEvent` objects when the enrollment exceeds the cap, and notifying the listeners by invoking the listeners' `actionPerformed` method. Listing 36.2 implements the new class.

**Listing 36.2 CourseWithActionEvent.java**

```
<margin note line 6: store students>
<margin note line 7: enrollmentCap>
<margin note line 8: store listeners>
<margin note line 10: no-arg constructor>
<margin note line 13: constructor>
<margin note line 17: return courseName>
<margin note line 23: create event>
<margin note line 46: register listener>
<margin note line 58: remove listener>
<margin note line 67: process event>
```

Show Code Without Line Numbers

```
1 import java.util.*;
2 import java.awt.event.*;
3
```

```

4 public class CourseWithActionEvent {
5 private String courseName = "default name";
6 private ArrayList<String> students = new ArrayList<String>();
7 private int enrollmentCap = 10;
8 private ArrayList<ActionListener> actionListenerList;
9
10 public CourseWithActionEvent() {
11 }
12
13 public CourseWithActionEvent(String courseName) {
14 this.courseName = courseName;
15 }
16
17 public String getCourseName() {
18 return courseName;
19 }
20
21 public void addStudent(String student) {
22 if (students.size() >= enrollmentCap) // Fire ActionEvent
23 processEvent(new ActionEvent(this,
24 ActionEvent.ACTION_PERFORMED, null));
25 else
26 students.add(student);
27 }
28
29 public ArrayList<String> getStudents() {
30 return students;
31 }
32
33 public int getNumberOfStudents() {
34 return students.size();
35 }
36
37 public int getEnrollmentCap() {
38 return enrollmentCap;
39 }
40
41 public void setEnrollmentCap(int enrollmentCap) {
42 this.enrollmentCap = enrollmentCap;
43 }
44
45 /** Register an action event listener */
46 public synchronized void addActionListener
47 (ActionListener listener) {
48 if (actionListenerList == null) {
49 actionListenerList = new ArrayList<ActionListener>(2);
50 }
51
52 if (!actionListenerList.contains(listener)) {
53 actionListenerList.add(listener);
54 }
55 }
56
57 /** Remove an action event listener */
58 public synchronized void removeActionListener
59 (ActionListener listener) {
60 if (actionListenerList !=
61 null && actionListenerList.contains(listener)) {
62 actionListenerList.remove(listener);

```



```

63 }
64 }
65
66 /** Fire ActionEvent */
67 private void processEvent(ActionEvent e) {
68 ArrayList<ActionListener> list;
69
70 synchronized (this) {
71 if (actionListenerList == null) return;
72 list = (ArrayList<ActionListener>)actionListenerList.clone();
73 }
74
75 for (int i = 0; i < list.size(); i++) {
76 ActionListener listener = (ActionListener)list.get(i);
77 listener.actionPerformed(e);
78 }
79 }
80 }

```

Since the source component is designed for multiple listeners, a `java.util.ArrayList` instance `actionListenerList` is used to hold all the listeners for the source component (line 8). The data type of the elements in the array list is `ActionListener`. To add a listener, `listener`, to `actionListenerList`, use

```
actionListenerList.add(listener); (line 53)
```

To remove a listener, `listener`, from `actionListenerList`, use

```
actionListenerList.remove(listener); (line 62)
```

The `if` statement (lines 52-53) ensures that the `addActionListener` method does not add the listener twice if it is already in the list. The `removeActionListener` method removes a listener if it is in the list. `actionListenerList` is an instance of `ArrayList`, which functions as a flexible array that can grow or shrink dynamically. Initially, `actionListenerList` is of size 2, but the capacity can be changed dynamically. If more than two listeners are added to `actionListenerList`, the list size will be automatically increased.

NOTE

**<margin note: storing listeners>**

Instead of using `ArrayList`, you can also use `javax.swing.event.EventListenerList` to store listeners. Using `EventListenerList` is preferred, since it provides the support for synchronization and is efficient in the case of no listeners.

The `addActionListener` and `removeActionListener` methods are synchronized to prevent data corruption on `actionListenerList` when attempting to register multiple listeners concurrently (lines 46, 58).

The `addStudent` method (lines 21-27) checks whether the number of students is more than the enrollment cap. If so, it creates an `ActionEvent` and invokes the `processEvent` method to process the event (lines 23-24). If not, add a new student to the course (line 26).

The UML diagram for `ActionEvent` is shown in Figure 36.2. To create an `ActionEvent`, use the constructor

```
ActionEvent(Object source, int id, String command)
```

where *source* specifies the source component, *id* identifies the event, and *command* specifies a command associated with the event. Use `ActionEvent.ACTION_PERFORMED` for the *id*. If you don't want to associate a command with the event, use `null`.

The `processEvent` method (lines 67-79) is invoked when an `ActionEvent` is generated. This notifies the listeners in `actionListenerList` by calling each listener's `actionPerformed` method to process the event. It is possible that a new listener may be added or an existing listener may be removed when `processEvent` is running. To avoid corruption on `actionListenerList`, a clone `list` of `actionListenerList` is created for use to notify listeners. To avoid corruption when creating the clone, invoke it in a synchronized block, as in lines 70-73:

```
synchronized (this) {
 if (actionListenerList == null) return;
 list = (ArrayList)actionListenerList.clone();
}
```

Listing 36.3 gives a test program that creates a course using the new class (line 5), sets the enrollment cap to 2 (line 8), registers a listener (line 9), and adds three students to the course (lines 11-13). When line 13 is executed, the `addStudent` method adds student Tim to the course and fires an `ActionEvent` because the course exceeds the enrollment cap. The course object invokes the listener's `actionPerformed` method to process the event and displays a message `Enrollment cap exceeded`.

### Listing 36.3 TestCourseWithActionEvent.java

*<margin note line 5: create course>*  
*<margin note line 8: set enrollmentCap>*  
*<margin note line 9: create listener>*  
*<margin note line 10: register listener>*  
*<margin note line 11: add students>*

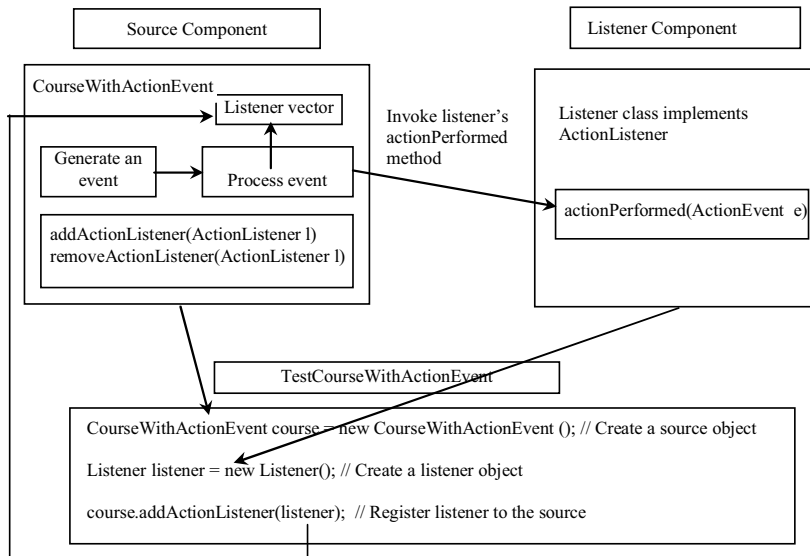
```
1 import java.awt.event.*;
2
3 public class TestCourseWithActionEvent {
4 CourseWithActionEvent course =
5 new CourseWithActionEvent("Java Programming");
6
7 public TestCourseWithActionEvent() {
8 course.setEnrollmentCap(2);
9 ActionListener listener = new Listener();
10 course.addActionListener(listener);
11 course.addStudent("John");
12 course.addStudent("Jim");
13 course.addStudent("Tim");
14 }
15
16 public static void main(String[] args) {
17 new TestCourseWithActionEvent();
18 }
19
20 private class Listener implements ActionListener {
21 @Override
```

```

22 public void actionPerformed(ActionEvent e) {
23 System.out.println("Enrollment cap exceeded");
24 }
25 }
26 }

```

The flow of event processing from the source to the listener is shown in Figure 36.6.



**Figure 36.6**

The listener is registered with the source `course`, and the source invokes the listener's handler `actionPerformed` to process the event.

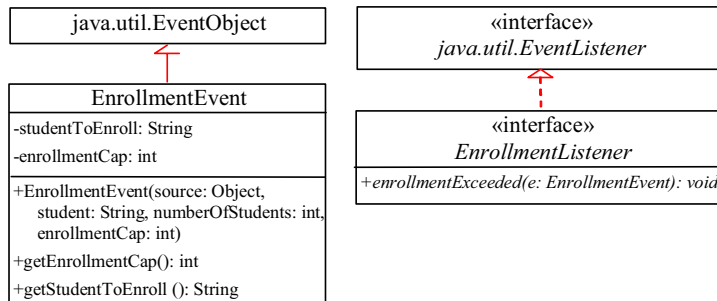
### 36.6 Creating Custom Event Sets

The Java API provides many event sets. You have used the event set `ActionEvent/ActionListener` in the preceding section. A course object fires an `ActionEvent` when the enrollment cap is exceeded. It is convenient to use the existing event sets in the Java API, but they are not always adequate. Sometimes you need to define custom event classes in order to obtain information not available in the existing API event classes. For example, suppose you want to know the enrollment cap and the number of students in the course; an `ActionEvent` object does not provide such information. You have to define your own event class and event listener interface.

A custom event class must extend `java.util.EventObject` or a subclass of `java.util.EventObject`. Additionally, it may provide constructors to create events, data members, and methods to describe events.

A custom event listener interface must extend `java.util.EventListener` or a subinterface of `java.util.EventListener` and define the signature of the handlers for the event. By convention, the listener interface should be named `XListener` for the corresponding event class named `XEvent`. For example, `ActionListener` is the listener interface for `ActionEvent`.

Let us define `EnrollmentEvent` as the event class for describing the enrollment event and its corresponding listener interface `EnrollmentListener` for defining an `enrollmentExceeded` handler, as shown in Figure 36.7. The `getStudentToEnroll()` method returns the student who attempts to enroll the course.



**Figure 36.7** `EnrollmentEvent` and `EnrollmentListener` comprise an event set for enrollment event.

The source code for the enrollment event set is given in Listings 36.4 and 36.5.

#### Listing 36.4 EnrollmentEvent.java

```

<margin note line 1: extends EventObject>
<margin note line 6: constructor>
<margin note line 8: invoke superclass constructor>

1 public class EnrollmentEvent extends java.util.EventObject {
2 private String studentToEnroll;
3 private int enrollmentCap;
4
5 /** Construct a EnrollmentEvent */
6 public EnrollmentEvent(Object source, String studentToEnroll,
7 int enrollmentCap) {
8 super(source);
9 this.studentToEnroll = studentToEnroll;
10 this.enrollmentCap = enrollmentCap;
11 }
12
13 public String getStudentToEnroll() {
14 return studentToEnroll;
15 }
16
17 public long getEnrollmentCap() {
18 return enrollmentCap;
19 }
20 }

```

#### Listing 36.5 EnrollmentListener.java

```

<margin note line 1: extends EventListener>
<margin note line 3: handler>

1 public interface EnrollmentListener extends java.util.EventListener {
2 /** Handle an EnrollmentEvent, to be implemented by a listener */
3 public void enrollmentExceeded(EnrollmentEvent e);

```

4 }

An event class is an extension of `EventObject`. To construct an event, the constructor of `EventObject` must be invoked by passing a source object as the argument. In the constructor for `EnrollmentEvent`, `super(source)` (line 8) invokes the superclass's constructor with the source object as the argument. `EnrollmentEvent` contains the information pertaining to the event, such as number of students and enrollment cap.

`EnrollmentListener` simply extends `EventListener` and defines the `enrollmentExceeded` method for handling enrollment events.

NOTE

*<margin note: specifying a source for an event>*

An event class does not have a no-arg constructor, because you must always specify a source for the event when creating an event.

Let us revise `CourseWithActionEvent` in Listing 36.2 to use `EnrollmentEvent/EnrollmentListener` instead of `ActionEvent/ActionListener`. The new class named `CourseWithEnrollmentEvent` in Listing 36.6 is very similar to `CourseWithActionEvent` in Listing 36.2.

#### Listing 36.6 CourseWithEnrollmentEvent.java

```
<margin note line 5: store students>
<margin note line 6: enrollmentCap>
<margin note line 8: store listeners>
<margin note line 10: no-arg constructor>
<margin note line 13: constructor>
<margin note line 22: create event>
<margin note line 45: register listener>
<margin note line 57: remove listener>
<margin note line 66: process event>

1 import java.util.*;
2
3 public class CourseWithEnrollmentEvent {
4 private String courseName = "default name";
5 private ArrayList<String> students = new ArrayList<String>();
6 private int enrollmentCap = 10;
7 private ArrayList<EnrollmentListener> enrollmentListenerList;
8
9 public CourseWithEnrollmentEvent() {
10 }
11
12 public CourseWithEnrollmentEvent(String courseName) {
13 this.courseName = courseName;
14 }
15
16 public String getCourseName() {
17 return courseName;
18 }
19
20 public void addStudent(String student) {
21 if (students.size() == enrollmentCap) // Fire EnrollmentEvent
22 processEvent(new EnrollmentEvent(this,
23 student, enrollmentCap));
24 else
25 students.add(student);
```

```

26 }
27
28 public ArrayList<String> getStudents() {
29 return students;
30 }
31
32 public int getNumberOfStudents() {
33 return students.size();
34 }
35
36 public int getEnrollmentCap() {
37 return enrollmentCap;
38 }
39
40 public void setEnrollmentCap(int enrollmentCap) {
41 this.enrollmentCap = enrollmentCap;
42 }
43
44 /** Register an action event listener */
45 public synchronized void addEnrollmentListener
46 (EnrollmentListener listener) {
47 if (enrollmentListenerList == null) {
48 enrollmentListenerList = new ArrayList<EnrollmentListener>(2);
49 }
50
51 if (!enrollmentListenerList.contains(listener)) {
52 enrollmentListenerList.add(listener);
53 }
54 }
55
56 /** Remove an action event listener */
57 public synchronized void removeEnrollmentListener
58 (EnrollmentListener listener) {
59 if (enrollmentListenerList !=
60 null && enrollmentListenerList.contains(listener)) {
61 enrollmentListenerList.remove(listener);
62 }
63 }
64
65 /** Fire EnrollmentEvent */
66 private void processEvent(EnrollmentEvent e) {
67 ArrayList<EnrollmentListener> list;
68
69 synchronized (this) {
70 if (enrollmentListenerList == null) return;
71 list = (ArrayList<EnrollmentListener>)
72 enrollmentListenerList.clone();
73 }
74
75 for (int i = 0; i < list.size(); i++) {
76 EnrollmentListener listener = (EnrollmentListener)list.get(i);
77 listener.enrollmentExceeded(e);
78 }
79 }
80 }

```

Line 8 creates a `java.util.ArrayList` instance `enrollmentListenerList` for holding all the listeners for the source component. The data type of the elements in the array list is `EnrollmentListener`. The

registration and deregistration methods for `EnrollmentListener` are defined in lines 45, 57.

The `addStudent` method checks whether the number of students is more than the enrollment cap. If so, it creates an `EnrollmentEvent` and invokes the `processEvent` method to process the event (lines 22-23). If not, add a new student to the course (line 25).

To create an `EnrollmentEvent`, use the constructor

```
EnrollmentEvent(Object source, String studentToEnroll,
 int enrollmentCap)
```

where `source` specifies the source component.

The `processEvent` method (lines 66-78) is invoked when an `EnrollmentEvent` is generated. This notifies the listeners in `enrollmentListenerList` by calling each listener's `enrollmentExceeded` method to process the event.

Let us revise the test program in Listing 36.3 to use `EnrollmentEvent/EnrollmentListener` instead of `ActionEvent/ActionListener`. The new program, given in Listing 36.7, creates a course using `CourseWithEnrollmentEvent` (line 3), sets the enrollment cap to 2 (line 6), creates an enrollment listener (line 7), registers it (line 8), and adds three students to the course (lines 9-11). When line 11 is executed, the `addStudent` method adds student Tim to the course and fires an `EnrollmentEvent` because the course exceeds the enrollment cap. The course object invokes the listener's `enrollmentExceeded` method to process the event and displays the number of students in the course and the enrollment cap.

#### Listing 36.7 TestCourseWithEnrollmentEvent.java

```
<margin note line 3: create course>
<margin note line 6: set enrollmentCap>
<margin note line 7: create listener>
<margin note line 8: register listener>
<margin note line 9: add students>

1 public class TestCourseWithEnrollmentEvent {
2 CourseWithEnrollmentEvent course =
3 new CourseWithEnrollmentEvent("Java Programming");
4
5 public TestCourseWithEnrollmentEvent() {
6 course.setEnrollmentCap(2);
7 EnrollmentListener listener = new NewListener();
8 course.addEnrollmentListener(listener);
9 course.addStudent("John Smith");
10 course.addStudent("Jim Peterson");
11 course.addStudent("Tim Johnson");
12 }
13
14 public static void main(String[] args) {
15 new TestCourseWithEnrollmentEvent();
16 }
17
18 private class NewListener implements EnrollmentListener {
19 public void enrollmentExceeded(EnrollmentEvent e) {
20 System.out.println(e.getStudentToEnroll() + " attempted to "
21 + "enroll. The enrollment cap is " + e.getEnrollmentCap());
```

```

22 }
23 }
24 }

```

<Output>

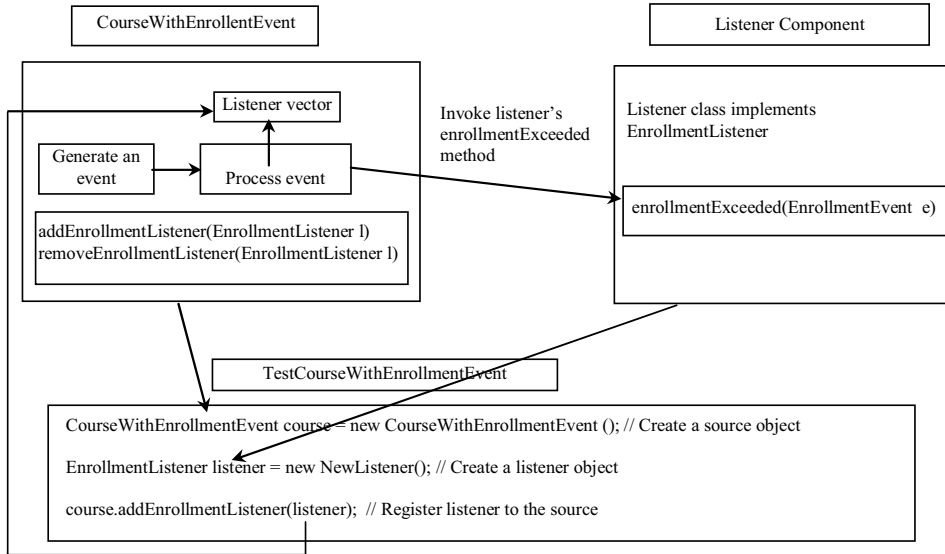
```

Tim Johnson attempted to enroll
The enrollment cap is 2

```

<End Output>

The flow of event processing from the source to the listener is shown in Figure 36.8.



**Figure 36.8**

The listener is registered with the source *course*, and the source invokes the listener's handler *enrollmentExceeded* to process the event.

TIP

<margin note: *ActionEvent*>

Using the *ActionEvent/ActionListener* event set is sufficient in most cases. Normally, the information about the event can be obtained from the source. For example, the number of students in the course and the enrollment can all be obtained from a course object. The source can be obtained by invoking *e.getSource()* for any event *e*.

NOTE

<margin note: *inheriting features*>

The *EnrollmentEvent* component is created from scratch. If you build a new component that extends a component capable of generating events, the new component inherits the ability to generate the same type of events. For example, since *JButton* is a subclass of *java.awt.Component* that can fire *MouseEvent*, *JButton* can also detect and generate mouse events. You don't need to



write the code to generate these events and register listeners for them, since the code is already given in the superclass. However, you still need to write the code to make your component capable of firing events not supported in the superclass.

### Key Terms

- **event set**
- **JavaBeans component**
- **JavaBeans events**
- **JavaBeans properties**

### Chapter Summary

1. JavaBeans is a software component architecture that extends the power of the Java language for building reusable software components. JavaBeans properties describe the state of the bean. Naturally, data fields are used to store properties. However, a bean property is not necessarily a data field.
2. A source component must have the appropriate registration and deregistration methods for adding and removing listeners. Events can be unicasted (only one listener object is notified of the event) or multicasted (each object in a list of listeners is notified of the event).
3. An event object is created using an event class, such as `ActionEvent`, `MouseEvent`, and `ItemEvent`. All event classes extend `java.util.EventObject`. Every event class is associated with an event listener interface that defines one or more methods referred to as *handlers*. An event listener interface is a subinterface of `java.util.EventListener`. Since an event class and its listener interface are coexistent, they are often referred to as an *event set* or *event pair*.

### Test Questions

Do the test questions for this chapter online at  
[www.cs.armstrong.edu/liang/intro9e/test.html](http://www.cs.armstrong.edu/liang/intro9e/test.html).

### Review Questions

*Sections 36.1-36.4*

36.1

What is a JavaBeans component? Is every GUI class a JavaBeans component? Is every GUI user interface component a JavaBeans component? Is it true that a JavaBeans component must be a GUI user interface component?

36.2

Describe the naming conventions for accessor and mutator methods in a JavaBeans component.

36.3

Describe the naming conventions for JavaBeans registration and deregistration methods.

36.4

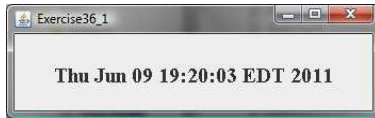
What is an event pair? How do you define an event class? How do you define an event listener interface?

### Programming Exercises

*Sections 36.1-36.6*

36.1\*

(Enable `MessagePanel` to fire `ActionEvent`) The `MessagePanel` class in Listing 15.7 is a subclass of `JPanel`; it can fire a `MouseEvent`, `KeyEvent`, and `ComponentEvent`, but not an `ActionEvent`. Modify the `MessagePanel` class so that it can fire an `ActionEvent` when an instance of the `MessagePanel` class is clicked. Name the new class `MessagePanelWithActionEvent`. Test it with a Java applet that displays the current time in a message panel whenever the message panel is clicked, as shown in Figure 36.9.



**Figure 36.9**

The current time is displayed whenever you click on the message panel.

### 36.2\*

(Create custom event sets and source components) Develop a project that meets the following requirements:

- Create a source component named `MemoryWatch` for monitoring memory. The component generates a `MemoryEvent` when the free memory space exceeds a specified `highLimit` or is below a specified `lowLimit`. The `highLimit` and `lowLimit` are customizable properties in `MemoryWatch`.
- Create an event set named `MemoryEvent` and `MemoryListener`. The `MemoryEvent` simply extends `java.util.EventObject` and contains two methods, `freeMemory` and `totalMemory`, which return the free memory and total memory of the system. The `MemoryListener` interface contains two handlers, `sufficientMemory` and `insufficientMemory`. The `sufficientMemory` method is invoked when the free memory space exceeds the specified high limit, and `insufficientMemory` is invoked when the free memory space is less than the specified low limit. The free memory and total memory in the system can be obtained using

```
Runtime runtime = Runtime.getRuntime();
runtime.freeMemory();
runtime.totalMemory();
```

- Develop a listener component that displays free memory, total memory, and whether the memory is sufficient or insufficient when a `MemoryEvent` occurs. Make the listener an applet with a `main` method to run standalone.

### 36.3\*\*

(The `Hurricane` source component) Create a class named `Hurricane` with properties `name` and `category` and its accessor methods. The `Hurricane` component generates an `ActionEvent` whenever its `category` property is changed. Write a listener that displays the hurricane category. If the category is 2 or greater, a message "`Hurricane Warning!!!`" is displayed, as shown in Figure 36.10.

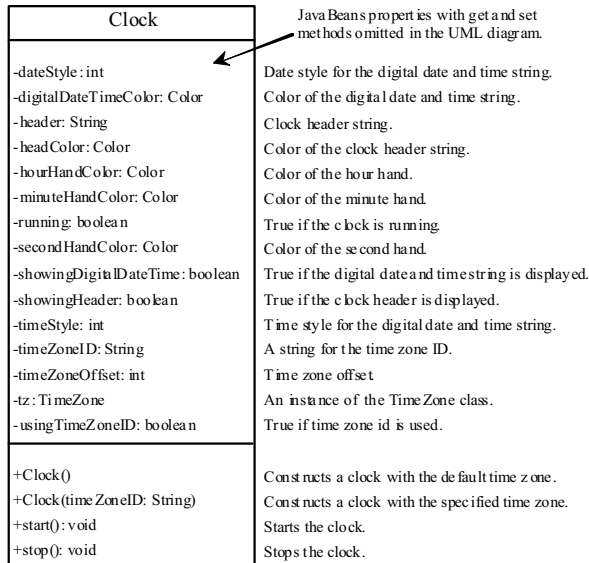


**Figure 36.10**

Whenever the hurricane category is changed, an appropriate message is displayed in the message panel.

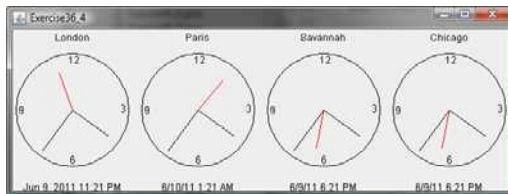
### 36.4\*\*

(The `Clock` source component) Create a JavaBeans component for displaying an analog clock. This bean allows the user to customize a clock through the properties, as shown in Figure 36.11. Write a test program that displays four clocks, as shown in Figure 36.12.



**Figure 36.11**

The `Clock` component displays an analog clock.



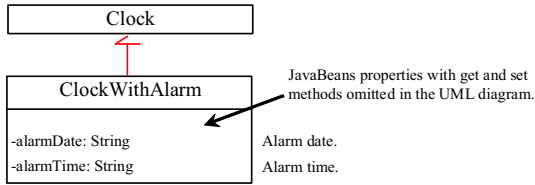
**Figure 36.12**

The program displays six clocks using the `Clock` component.

### 36.5\*

(Create `ClockWithAlarm` from `Clock`) Create an alarm clock, named `ClockWithAlarm`, which extends the `Clock` component built in the preceding exercise, as shown in Figure 36.13. This component contains two new properties, `alarmDate` and `alarmTime`. `alarmDate` is a string consisting of year, month, and day, separated by commas. For example, 1998,5,13 represents the year 1998, month 5, and day 13. `alarmTime` is a string consisting of hour, minute, and second, separated by commas. For example, 10,45,2 represents 10 o'clock, 45 minutes, and 2 seconds. When the clock time matches the alarm time, `ClockWithAlarm` fires an `ActionEvent`. Write a test program that displays the alert

message "You have an appointment now" on a dialog box at a specified time (e.g., date: 2004,1,1 and time: 10,30,0).

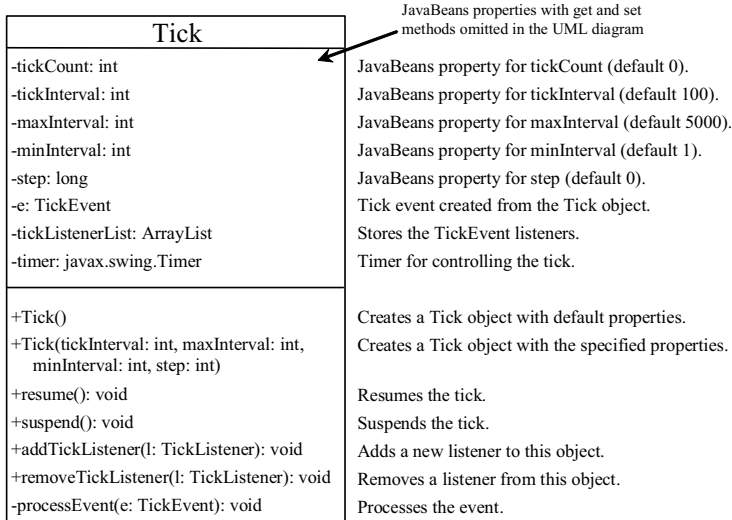


**Figure 36.13**

The *ClockWithAlarm* component extends *Clock* with alarm functions.

### 36.6\*\*\*

(The *Tick* source component) Create a custom source component that is capable of generating tick events at variant time intervals, as shown in Figure 36.14. The *Tick* component is similar to *javax.swing.Timer*. The *Timer* class generates a timer at fixed time intervals. This *Tick* component can generate tick events at variant as well as at fixed time intervals.

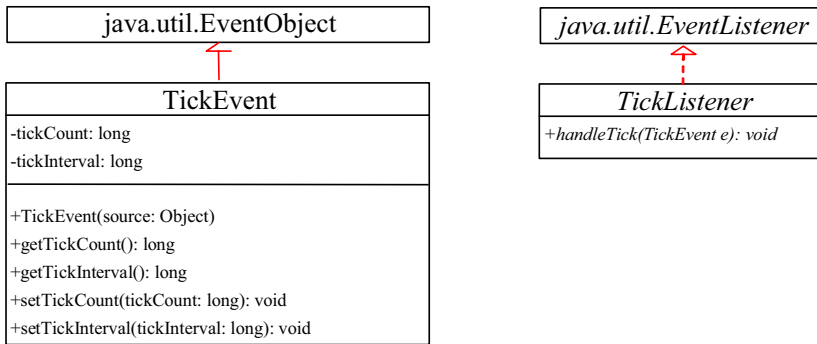


**Figure 36.14**

*Tick* is a component that generates *TickEvent*.

The component contains the properties *tickCount*, *tickInterval*, *maxInterval*, *minInterval*, and *step*. The component adjusts the *tickInterval* by adding *step* to it after a tick event occurs. If *step* is 0, *tickInterval* is unchanged. If *step* > 0, *tickInterval* is increased. If *step* < 0, *tickInterval* is decreased. If *tickInterval* > *maxInterval* or *tickInterval* < *minInterval*, the component will no longer generate tick events.

The *Tick* component is capable of registering multiple listeners, generating *TickEvent* objects at variant time intervals, and notifying the listeners by invoking the listeners' *handleTick* method. The UML diagram for *TickEvent* and *TickListener* is shown in Figure 36.15.



**Figure 36.15**

`TickEvent` and `TickListener` comprise an event set for a tick event.

Create an applet named `DisplayMovingMessage`, and create a panel named `MovingMessage` to display the message. Place an instance of the panel in the applet. To enable the message to move rightward, redraw the message with a new incremental x-coordinate. Use a `Tick` object to generate a tick event and invoke the `repaint` method to redraw the message when a tick event occurs. To move the message at a decreasing pace, use a positive step (e.g., 10) when constructing a `Tick` object.

**\*\*\*This is a bonus Web chapter**

## **CHAPTER 37**

### **Containers, Layout Managers, and Borders**

#### **Objectives**

- To explore the internal structures of the Swing container (§37.2).
- To explain how a layout manager works in Java (§37.3).
- To use *CardLayout* and *BoxLayout* (§§37.3.1-37.3.2).
- To use the absolute layout manager to place components in the fixed position (§37.3.3).
- To create custom layout managers (§37.4).
- To use *JScrollPane* to create scroll panes (§37.5).
- To use *JTabbedPane* to create tabbed panes (§37.6).
- To use *JSplitPane* to create split panes (§37.7).
- To use various borders for Swing components (§37.8).

## 37.1 Introduction

<margin note: container>

<margin note: layout manager>

Chapter 12, "GUI Basics," introduced the concept of containers and the role of layout managers. You learned how to add components into a container and how to use *FlowLayout*, *BorderLayout*, and *GridLayout* to arrange components in a container. A *container* is an object that holds and groups components. A *layout manager* is a special object used to place components in a container. Containers and layout managers play a crucial role in creating user interfaces. This chapter presents a conceptual overview of containers, reviews the layout managers in Java, and introduces several new containers and layout managers. You will also learn how to create custom layout managers and use various borders.

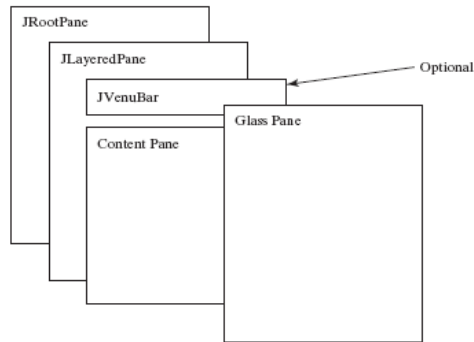
## 37.2 Swing Container Structures

User interface components like *JButton* cannot be displayed without being placed in a container. A container is a component that holds other components. You do not display a user interface component; you place it in a container, and the container displays the components it contains.

The base class for all containers is *java.awt.Container*, which is a subclass of *java.awt.Component*. The *Container* class has the following essential functions:

- It adds and removes components using various *add* and *remove* methods.
- It maintains a *layout* property for specifying a layout manager that is used to lay out components in the container. Every container has a default layout manager.
- It provides registration methods for the *java.awt.event.ContainerEvent*.

In AWT programming, the *java.awt.Frame* class is used as a top-level container for Java applications, the *java.awt.Applet* class is used for all Java applets, and *java.awt.Dialog* is used for dialog windows. These classes do not work properly with Swing lightweight components. Special versions of *Frame*, *Applet*, and *Dialog* named *JFrame*, *JApplet*, and *JDialog* have been developed to accommodate Swing components. *JFrame* is a subclass of *Frame*, *JApplet* is a subclass of *Applet*, and *JDialog* is a subclass of *Dialog*. *JFrame* and *JApplet* inherit all the functions of their heavyweight counterparts, but they have a more complex internal structure with several layered panes, as shown in Figure 37.1.



**Figure 37.1**

*Swing top-level containers use layers of panes to group lightweight components and make them work properly.*

`javax.swing.JRootPane` is a lightweight container used behind the scenes by Swing's top-level containers, such as `JFrame`, `JApplet`, and `JDialog`. `javax.swing.JLayeredPane` is a container that manages the optional menu bar and the content pane. The content pane is an instance of `Container`. By default, it is a `JPanel` with `BorderLayout`. This is the container where the user interface components are added. To obtain the content pane in a `JFrame` or in a `JApplet`, use the `getContentPane()` method. If you wish to set an instance of `Container` to be a new content pane, use the `setContentPane` method. The glass pane floats on top of everything. `javax.swing.JGlassPane` is a hidden pane by default. If you make the glass pane visible, then it's like a sheet of glass over all the other parts of the root pane. It's completely transparent, unless you implement the glass pane's `paint` method so that it paints something, and it intercepts input events for the root pane. In general, `JRootPane`, `JLayeredPane`, and `JGlassPane` are not used directly.

Now let us review the three most frequently used Swing containers: `JFrame`, `JApplet`, and `JPanel`.

### 37.2.1 `JFrame`

`JFrame`, a Swing version of `Frame`, is a top-level container for Java graphics applications. Like `Frame`, `JFrame` is displayed as a standalone window with a title bar and a border. The following properties are often useful in `JFrame`:

- `contentPane` is the content pane of the frame.
- `iconImage` is the image that represents the frame. This image replaces the default Java image on the frame's title bar and is also displayed when the frame is minimized. This property type is `Image`. You can get an image using the `ImageIcon` class, as follows:

```
Image image = (new ImageIcon(filename)).getImage();
```

- `jMenuBar` is the optional menu bar for the frame.



- `resizable` is a `boolean` value indicating whether the frame is resizable. The default value is `true`.
- `title` specifies the title of the frame.

### 37.2.2 `JApplet`

`JApplet` is a Swing version of `Applet`. Since it is a subclass of `Applet`, it has all the functions required by the Web browser. Here are the four essential methods defined in `Applet`:

```
// Called by the browser when the Web page containing
// this applet is initially loaded
public void init()

// Called by the browser after the init() method and
// every time the Web page is visited.
public void start()

// Called by the browser when the page containing this
// applet becomes inactive.
public void stop()

// Called by the browser when the Web browser exits.
public void destroy()
```

Additionally, `JApplet` has the `contentPane` and `jMenuBar` properties, among others. As with `JFrame`, you do not place components directly into `JApplet`; instead you place them into the content pane of the applet. The `Applet` class cannot have a menu bar, but the `JApplet` class allows you to set a menu bar using the `setJMenuBar` method.

NOTE: When an applet is loaded, the Web browser creates an instance of the applet by invoking the applet's no-arg constructor. So the constructor is invoked before the `init` method.

### 37.2.3 `JPanel`

Panels act as subcontainers for grouping user interface components. `javax.swing.JPanel` is different from `JFrame` and `JApplet`. First, `JPanel` is not a top-level container; it must be placed inside another container, and it can be placed inside another `JPanel`. Second, since `JPanel` is a subclass of `JComponent`, it is a lightweight component, but `JFrame` and `JApplet` are heavyweight components.

As a subclass of `JComponent`, `JPanel` can take advantage of `JComponent`, such as double buffering and borders. You should draw figures on `JPanel` rather than `JFrame` or `JApplet`, because `JPanel` supports double buffering, which is the technique for eliminating flickers.

## 37.3 Layout Managers

Every container has a layout manager that is responsible for arranging its components. The container's `setLayout` method can be used to set a layout manager. Certain types of containers have default layout managers. For instance, the content pane of `JFrame` or `JApplet` uses `BorderLayout`, and `JPanel` uses `FlowLayout`.

The layout manager places the components in accordance with its own rules and property settings, and with the constraints associated with each component. Every layout manager has its own specific set of rules. For example, the `FlowLayout` manager places components in rows from left to right and starts a new row when the previous row is filled. The `BorderLayout` manager places components in the north, south, east, west, or center of the container. The `GridLayout` manager places components in a grid of cells in rows and columns from left to right in order.

Some layout managers have properties that can affect the sizing and location of the components in the container. For example, `BorderLayout` has properties called `hgap` (horizontal gap) and `vgap` (vertical gap) that determine the distance between components horizontally and vertically. `FlowLayout` has properties that can be used to specify the alignment (left, center, right) of the components and properties for specifying the horizontal or vertical gap between the components. `GridLayout` has properties that can be used to specify the horizontal or vertical gap between columns and rows and properties for specifying the number of rows and columns. These properties can be retrieved and set using their accessor and mutator methods

The size of a component in a container is determined by many factors, such as:

- The type of layout manager used by the container.
- The layout constraints associated with each component.
- The size of the container.
- Certain properties common to all components (such as `preferredSize`, `minimumSize`, `maximumSize`, `alignmentX`, and `alignmentY`).

The `preferredSize` property indicates the ideal size at which the component looks best. Depending on the rules of the particular layout manager, this property may or may not be considered. For example, the preferred size of a component is used in a container with a `FlowLayout` manager, but ignored if it is placed in a container with a `GridLayout` manager.

The `minimumSize` property specifies the minimum size at which the component is useful. For most GUI components, `minimumSize` is the same as `preferredSize`. Layout managers generally respect `minimumSize` more than `preferredSize`.

The `maximumSize` property specifies the maximum size needed by a component, so that the layout manager won't wastefully give space to a component that does not need it. For instance, `BorderLayout` limits the center component's size to its maximum size, and gives the space to edge components.

The `alignmentX` (`alignmentY`) property specifies how the component would like to be aligned relative to other components along the x-axis (y-axis). This value should be a number between `0` and `1`, where `0` represents alignment along the origin, `1` is aligned the farthest away

from the origin, `0.5` is centered, and so on. These two properties are used in the `BoxLayout` and `OverlayLayout`.

Java provides a variety of layout managers. You have learned how to use `BorderLayout`, `FlowLayout`, and `GridLayout`. The sections that follow introduce `CardLayout`, `Null` layout, and `BoxLayout`. `GridBagLayout`, `OverlayLayout`, and `SpringLayout` are presented in Supplement III.S.

TIP: If you set a new layout manager in a container, invoke the container's `validate()` method to force the container to again lay out the components. If you change the properties of a layout manager in a `JFrame` or `JApplet`, invoke the `doLayout()` method to force the container to again lay out the components using the new layout properties. If you change the properties of a layout manager in a `JPanel`, invoke either `doLayout()` or `revalidate()` method to force it to again lay out the components using the new layout properties, but it is better to use `revalidate()`. Note that `validate()` is a public method defined in `java.awt.Container`, `revalidate()` is a public method defined in `javax.swing.JComponent`, and `doLayout()` is a public method defined in `java.awt.Container`.

### 37.3.1 `CardLayout`

`CardLayout` places components in the container as cards. Only one card is visible at a time, and the container acts as a stack of cards. The ordering of cards is determined by the container's own internal ordering of its component objects. You can specify the size of the horizontal and vertical gaps surrounding a stack of components in a `CardLayout` manager, as shown in Figure 37.2.

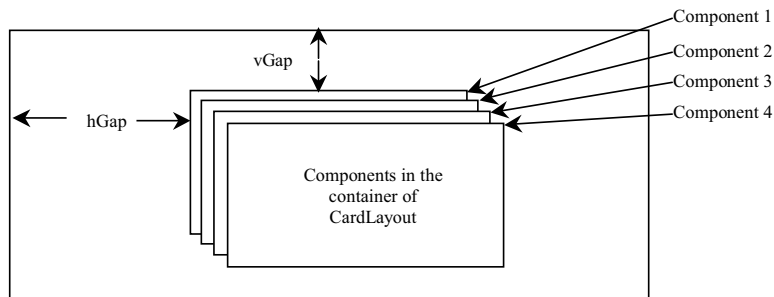
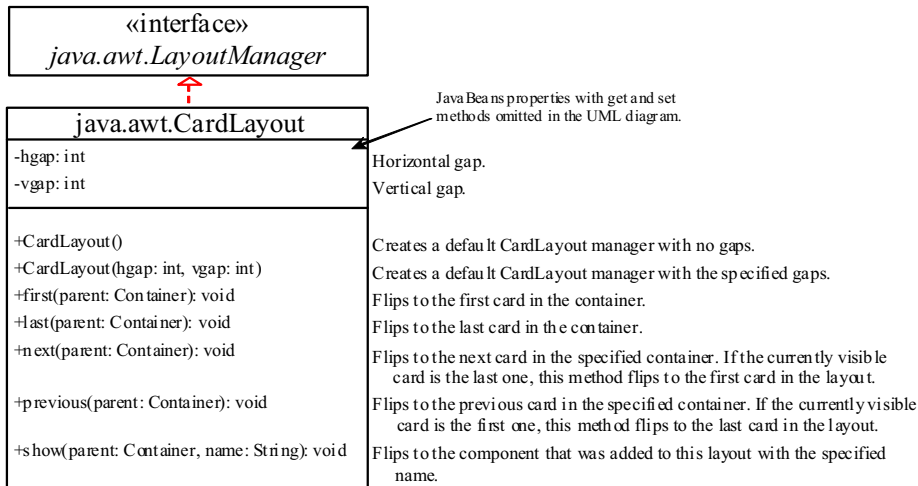


Figure 37.2

The `CardLayout` places components in the container as a stack of cards.

`CardLayout` defines a set of methods that allow an application to flip through the cards sequentially or to display a specified card directly, as shown in Figure 37.3.



**Figure 37.3**

*CardLayout* contains the methods to flip the card.

To add a component into a container, use the `add(Component c, String name)` method defined in the `LayoutManager` interface. The `String` parameter, `name`, gives an explicit identity to the component in the container.

Listing 37.1 gives a program that creates two panels in a frame. The first panel uses `CardLayout` to hold six labels for displaying images. The second panel uses `FlowLayout` to group four buttons named `First`, `Next`, `Previous`, and `Last`, and a combo box labeled `Image`, as shown in Figure 37.4.

These buttons control which image will be shown in the `CardLayout` panel. When the user clicks the button named `First`, for example, the first image in the `CardLayout` panel appears. The combo box enables the user to directly select an image.



**Figure 37.4**

The program shows images in a panel of `CardLayout`.

**Listing 37.1 ShowCardLayout.java**

```

<margin note line 6: card layout>
<margin note line 13: create UI>
<margin note line 41: register listener>
<margin note line 45: first component>

```

<margin note line 47: register listener>  
<margin note line 52: next component>  
<margin note line 55: register listener>  
<margin note line 59: previous component>  
<margin note line 62: register listener>  
<margin note line 66: last component>  
<margin note line 69: register listener>  
<margin note line 77: main method omitted>

```
1 import java.awt.*;
2 import java.awt.event.*;
3 import javax.swing.*;
4
5 public class ShowCardLayout extends JApplet {
6 private CardLayout cardLayout = new CardLayout(20, 10);
7 private JPanel cardPanel = new JPanel(cardLayout);
8 private JButton jbtFirst, jbtNext, jbtPrevious, jbtLast;
9 private JComboBox jcboImage;
10 private final int NUM_OF_FLAGS = 6;
11
12 public ShowCardLayout() {
13 cardPanel.setBorder(
14 new javax.swing.border.LineBorder(Color.red));
15
16 // Add 9 labels for displaying images into cardPanel
17 for (int i = 1; i <= NUM_OF_FLAGS; i++) {
18 JLabel label =
19 new JLabel(new ImageIcon("image/flag" + i + ".gif"));
20 cardPanel.add(label, String.valueOf(i));
21 }
22
23 // Panel p to hold buttons and a combo box
24 JPanel p = new JPanel();
25 p.add(jbtFirst = new JButton("First"));
26 p.add(jbtNext = new JButton("Next"));
27 p.add(jbtPrevious = new JButton("Previous"));
28 p.add(jbtLast = new JButton("Last"));
29 p.add(new JLabel("Image"));
30 p.add(jcboImage = new JComboBox());
31
32 // Initialize combo box items
33 for (int i = 1; i <= NUM_OF_FLAGS; i++)
34 jcboImage.addItem(String.valueOf(i));
35
36 // Place panels in the frame
37 add(cardPanel, BorderLayout.CENTER);
38 add(p, BorderLayout.SOUTH);
39
40 // Register listeners with the source objects
41 jbtFirst.addActionListener(new ActionListener() {
42 @Override
43 public void actionPerformed(ActionEvent e) {
44 // Show the first component in cardPanel
45 cardLayout.first(cardPanel);
46 }
47 });
48 jbtNext.addActionListener(new ActionListener() {
49 @Override
50 public void actionPerformed(ActionEvent e) {
```

```

51 // Show the first component in cardPanel
52 cardLayout.next(cardPanel);
53 }
54 });
55 jbtPrevious.addActionListener(new ActionListener() {
56 @Override
57 public void actionPerformed(ActionEvent e) {
58 // Show the first component in cardPanel
59 cardLayout.previous(cardPanel);
60 }
61 });
62 jbtLast.addActionListener(new ActionListener() {
63 @Override
64 public void actionPerformed(ActionEvent e) {
65 // Show the first component in cardPanel
66 cardLayout.last(cardPanel);
67 }
68 });
69 jchoImage.addItemListener(new ItemListener() {
70 @Override
71 public void itemStateChanged(ItemEvent e) {
72 // Show the component at specified index
73 cardLayout.show(cardPanel, (String)e.getItem());
74 }
75 });
76 }
77 }

```

An instance of `CardLayout` is created in line 6, and a panel of `CardLayout` is created in line 7. You have already used such statements as `setLayout(new FlowLayout())` to create an anonymous layout object and set the layout for a container, instead of creating a separate instance of the layout manager, as in this program. The `cardLayout` object, however, is useful later in the program to show components in `cardPanel`. You have to use `cardLayout.first(cardPanel)` (line 45), for example, to view the first component in `cardPanel`.

The statement in lines 18–20 adds the image label with the identity `String.valueOf(i)`. Later, when the user selects an image with number `i`, the identity `String.valueOf(i)` is used in the `cardLayout.show()` method (line 73) to view the image with the specified identity.

### 37.3.2 BoxLayout

`javax.swing.BoxLayout` is a Swing layout manager that arranges components in a row or a column. To create a `BoxLayout`, use the following constructor:

```
public BoxLayout(Container target, int axis)
```

This constructor is different from other layout constructors. It creates a layout manager that is dedicated to the given target container. The `axis` parameter is `BoxLayout.X_AXIS` or `BoxLayout.Y_AXIS`, which specifies whether the components are laid out horizontally or vertically. For example, the following code creates a horizontal `BoxLayout` for panel `p1`:

```
JPanel p1 = new JPanel();
```

```
BoxLayout boxLayout = new BoxLayout(p1, BoxLayout.X_AXIS);
p1.setLayout(boxLayout);
```

You still need to invoke the `setLayout` method on `p1` to set the layout manager.

You can use `BoxLayout` in any container, but it is simpler to use the `Box` class, which is a container of `BoxLayout`. To create a `Box` container, use one of the following two static methods:

```
Box box1 = Box.createHorizontalBox();
Box box2 = Box.createVerticalBox();
```

The former creates a box that contains components horizontally, the latter a box that contains components vertically. You can add components to a box in the same way that you add them to the containers of `FlowLayout` or `GridLayout` using the `add` method, as follows:

```
box1.add(new JButton("A Button"));
```

You can remove components from a box in the same way that you drop components to a container. The components are laid left to right in a horizontal box, and top to bottom in a vertical box. `BoxLayout` is similar to `GridLayout` but has many unique features. First, `BoxLayout` respects a component's preferred size, maximum size, and minimum size. If the total preferred size of all the components in the box is less than the box size, then the components are expanded up to their maximum size. If the total preferred size of all the components in the box is greater than the box size, then the components are shrunk down to their minimum size. If the components do not fit at their minimum width, some of them will not be shown. In the `GridLayout`, the container is divided into cells of equal size, and the components are fit in regardless of their preferred maximum or minimum size.

Second, unlike other layout managers, `BoxLayout` considers the component's `alignmentX` or `alignmentY` property. The `alignmentX` property is used to place the component in a vertical box layout, and the `alignmentY` property is used to place it in a horizontal box layout. Third, `BoxLayout` does not have gaps between the components, but you can use fillers to separate components. A filler is an invisible component. There are three kinds of fillers: struts, rigid areas, and glues.

**<side remark: strut>**

A *strut* simply adds some space between components. The static method `createHorizontalStrut(int)` in the `Box` class is used to create a horizontal strut, and the static method `createVerticalStrut(int)` to create a vertical strut. For example, the code shown below adds a vertical strut of 8 pixels between two buttons in a vertical box.

```
box2.add(new JButton("Button 1"));
box2.add(Box.createVerticalStrut(8));
box2.add(new JButton("Button 2"));
```

**<side remark: rigid area>**

A *rigid area* is a two-dimensional space that can be created using the static method `createRigidArea(dimension)` in the `Box` class. For

example, the next code adds a rigid area 10 pixels wide and 20 pixels high into a box.

```
box2.add(Box.createRigidArea(new Dimension(10, 20));
```

**<side remark: glue>**

A *glue* separates components as much as possible. For example, by adding a glue between two components in a horizontal box, you place one component at the left end and the other at the right end. A glue can be created using the `Box.createGlue()` method.

Listing 37.2 shows an example that creates a horizontal box and a vertical box. The horizontal box holds two buttons with print and save icons. The vertical box holds four buttons for selecting flags. When a button in the vertical box is clicked, a corresponding flag icon is displayed in the label centered in the applet, as shown in Figure 37.5.



**Figure 37.5**

The components are placed in the containers of `BoxLayout`.

**Listing 37.2 ShowBoxLayout.java**

**<margin note line 6: UI components>**  
**<margin note line 7: BoxLayout container>**  
**<margin note line 8: BoxLayout container>**  
**<margin note line 14: create icons>**  
**<margin note line 28: buttons>**  
**<margin note line 34: create UI>**  
**<margin note line 35: add to box>**  
**<margin note line 79: main method omitted>**

```
1 import java.awt.*;
2 import java.awt.event.*;
3 import javax.swing.*;
4
5 public class ShowBoxLayout extends JApplet {
6 // Create two box containers
7 private Box box1 = Box.createHorizontalBox();
8 private Box box2 = Box.createVerticalBox();
9
10 // Create a label to display flags
11 private JLabel jlblFlag = new JLabel();
12
13 // Create image icons for flags
14 private ImageIcon imageIconUS =
15 new ImageIcon(getClass().getResource("/image/us.gif"));
16 private ImageIcon imageIconCanada =
17 new ImageIcon(getClass().getResource("/image/ca.gif"));
18 private ImageIcon imageIconNorway =
19 new ImageIcon(getClass().getResource("/image/norway.gif"));
```



```

20 private ImageIcon imageIconGermany =
21 new ImageIcon(getClass().getResource("/image/germany.gif"));
22 private ImageIcon imageIconPrint =
23 new ImageIcon(getClass().getResource("/image/print.gif"));
24 private ImageIcon imageIconSave =
25 new ImageIcon(getClass().getResource("/image/save.gif"));
26
27 // Create buttons to select images
28 private JButton jbtUS = new JButton("US");
29 private JButton jbtCanada = new JButton("Canada");
30 private JButton jbtNorway = new JButton("Norway");
31 private JButton jbtGermany = new JButton("Germany");
32
33 public ShowBoxLayout() {
34 box1.add(new JButton(imageIconPrint));
35 box1.add(Box.createHorizontalStrut(20));
36 box1.add(new JButton(imageIconSave));
37
38 box2.add(jbtUS);
39 box2.add(Box.createVerticalStrut(8));
40 box2.add(jbtCanada);
41 box2.add(Box.createGlue());
42 box2.add(jbtNorway);
43 box2.add(Box.createRigidArea(new Dimension(10, 8)));
44 box2.add(jbtGermany);
45
46 box1.setBorder(new javax.swing.border.LineBorder(Color.red));
47 box2.setBorder(new javax.swing.border.LineBorder(Color.black));
48
49 add(box1, BorderLayout.NORTH);
50 add(box2, BorderLayout.EAST);
51 add(jlblFlag, BorderLayout.CENTER);
52
53 // Register listeners
54 jbtUS.addActionListener(new ActionListener() {
55 @Override
56 public void actionPerformed(ActionEvent e) {
57 lblFlag.setIcon(imageIconUS);
58 }
59 });
60 jbtCanada.addActionListener(new ActionListener() {
61 @Override
62 public void actionPerformed(ActionEvent e) {
63 lblFlag.setIcon(imageIconCanada);
64 }
65 });
66 jbtNorway.addActionListener(new ActionListener() {
67 @Override
68 public void actionPerformed(ActionEvent e) {
69 lblFlag.setIcon(imageIconNorway);
70 }
71 });
72 jbtGermany.addActionListener(new ActionListener() {
73 @Override
74 public void actionPerformed(ActionEvent e) {
75 lblFlag.setIcon(imageIconGermany);
76 }
77 });
78 }

```

Two containers of the `Box` class are created in lines 7-8 using the convenient static methods `createHorizontalBox()` and `createVerticalBox()`. The box containers always use the `BoxLayout` manager. You cannot reset the layout manager for the box containers.

The image icons are created from image files (lines 14-25) through resource URL, introduced in Section 18.10, "Locating Resource Using the `URL` Class."

Two buttons with print and save icons are added into the horizontal box (line 34-36). A horizontal strut with size `20` is added between these two buttons (line 35).

Four buttons with texts US, Canada, Norway, and Germany are added into the vertical box (lines 38-44). A horizontal strut with size `8` is added to separate the US button and the Canada button (line 39). A rigid area is inserted between the Norway button and the Germany button (line 43). A glue is inserted to separate the Canada button and the Norway button as far as possible in the vertical box.

The strut, rigid area, and glue are instances of `Component`, so they can be added to the box container. In theory, you can add them to a container other than the box container. But they may be ignored and have no effect in other containers.

### 37.3.3 Using Null Layout Manager

If you have used a Windows-based visual form design tool like Visual Basic, you know that it is easier to create user interfaces with Visual Basic than in Java. This is mainly because in Visual Basic the components are placed in absolute positions and sizes, whereas in Java they are placed in containers using a variety of layout managers. Absolute positions and sizes are fine if the application is developed and deployed on the same platform, but what looks fine on a development system may not look right on a deployment system. To solve this problem, Java provides a set of layout managers that place components in containers in a way that is independent of fonts, screen resolutions, and platform differences.

For convenience, Java also supports an absolute layout, called null layout manager, which enables you to place components at fixed locations. In this case, the component must be placed using the component's instance method `setBounds()` (defined in `java.awt.Component`), as follows:

```
public void setBounds(int x, int y, int width, int height);
```

This sets the location and size for the component, as in the next example:

```
JButton jbt = new JButton("Help");
jbt.setBounds(10, 10, 40, 20);
```

The upper-left corner of the `Help` button is placed at `(10, 10)`; the button width is `40`, and the height is `20`.

Here are the steps of adding a button to a container with a null layout manager:

1. Use this statement to specify a null layout manager:

<margin note: set null layout>

```
container.setLayout(null);
```

2. Add the component to the container:

```
JButton jbt = new JButton("Help");
container.add(jbt);
```

3. Specify the location where the component is to be placed, using the `setBounds` method:

<margin note: setBounds>

```
jbt.setBounds(10, 10, 40, 20);
```

Listing 37.3 gives a program that places three buttons, as shown in Figure 37.6a.

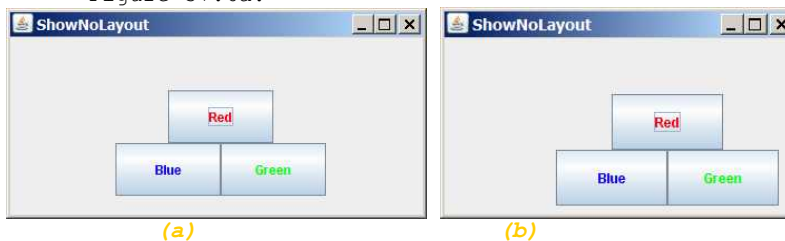


Figure 37.6

(a) The components are placed in the frame using a null layout manager. (b) With a null layout manager, the size and positions of the components are fixed.

#### Listing 37.3 ShowNoLayout.java

<margin note line 5: UI components>

<margin note line 11: create UI>

<margin note line 28: main method omitted>

```
1 import java.awt.*;
2 import javax.swing.*;
3
4 public class ShowNoLayout extends JApplet {
5 private JButton jbtRed = new JButton("Red");
6 private JButton jbtBlue = new JButton("Blue");
7 private JButton jbtGreen = new JButton("Green");
8
9 public ShowNoLayout() {
10 // Set foreground color for the buttons
11 jbtRed.setForeground(Color.RED);
12 jbtBlue.setForeground(Color.BLUE);
13 jbtGreen.setForeground(Color.GREEN);
14
15 // Specify no layout manager
16 setLayout(null);
17
18 // Add components to container
19 add(jbtRed);
```

```

20 add(jbtBlue);
21 add(jbtGreen);
22
23 // Put components in the right place
24 jbtRed.setBounds(150, 50, 100, 50);
25 jbtBlue.setBounds(100, 100, 100, 50);
26 jbtGreen.setBounds(200, 100, 100, 50);
27 }
28 }

```

If you run this program on Windows with 1024 × 768 resolution, the layout size is just right. When the program is run on Windows with a higher resolution, the components appear very small and clump together. When it is run on Windows with a lower resolution, they cannot be shown in their entirety.

If you resize the window, you will see that the location and the size of the components are not changed, as shown in Figure 37.6b.

#### TIP

Do not use the null-layout-manager to develop platform-independent applications.

### 37.4 Creating Custom Layout Managers

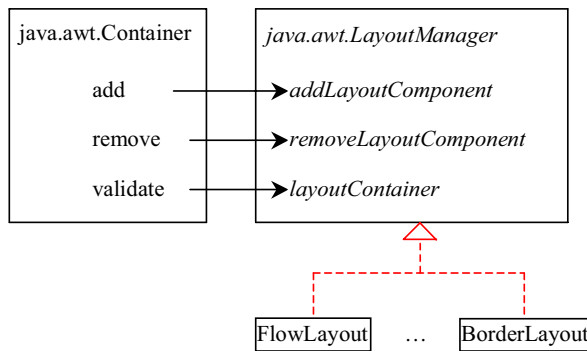
In addition to the layout managers provided in Java, you can create your own. To do so, you need to understand how a layout manager lays out components. A container's `setLayout` method specifies a layout manager for the container. The layout manager is responsible for laying out the components and displaying them in a desired location with an appropriate size. Every layout manager must directly or indirectly implement the `LayoutManager` interface. For instance, `FlowLayout` directly implements `LayoutManager`, and `BorderLayout` implements `LayoutManager2`, a subclass of `LayoutManager`. The `LayoutManager` interface provides the following methods for laying out components in a container:

- **public void** `addLayoutComponent(String name, Component comp)`  
Adds the specified component with the specified name to the container.
- **public void** `layoutContainer(Container parent)`  
Lays out the components in the specified container. In this method, you should provide concrete instructions that specify where the components are to be placed.
- **public** `Dimension minimumLayoutSize(Container parent)`  
Calculates the minimum size dimensions for the specified panel, given the components in the specified parent container.
- **public** `Dimension preferredLayoutSize(Container parent)`  
Calculates the preferred size dimensions for the specified panel, given the components in the specified parent container.

- **public void** removeLayoutComponent(Component comp)

Removes the specified component from the layout.

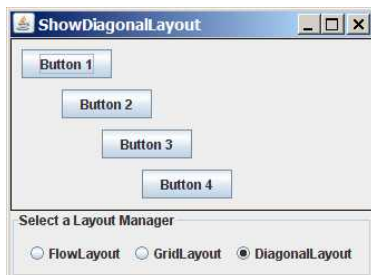
These methods in *LayoutManager* are invoked by the methods in the *java.awt.Container* class through the layout manager in the container. *Container* contains a property named *layout* (an instance of *LayoutManager*) and the methods for adding and removing components from the container. There are five overloading *add* methods defined in *Container* for adding components with various options. The *remove* method removes a component from the container. The *add* method invokes *addImpl*, which then invokes the *addLayoutComponent* method defined in the *LayoutManager* interface. The *layoutContainer* method in the *LayoutManager* interface is indirectly invoked by the *validate()* method through several calls. The *remove* method invokes *removeLayoutComponent* in *LayoutManager*. The *validate* method is invoked to refresh the container after the components it contains have been added to or modified. The relationship of *Container* and *LayoutManager* is shown in Figure 37.7.



**Figure 37.7**

The *add*, *remove*, and *validate* methods in *Container* invoke the methods defined in the *LayoutManager* interface.

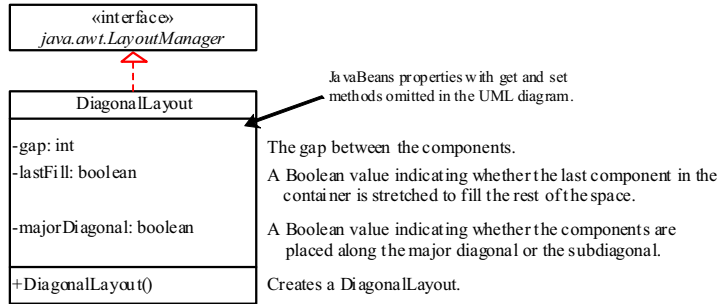
Let us define a custom layout manager named *DiagonalLayout* that places the components in a diagonal. To test *DiagonalLayout*, the example creates an applet with radio buttons named "FlowLayout," "GridLayout," and "DiagonalLayout," as shown in Figure 37.8. You can dynamically select one of these three layouts in the panel.



**Figure 37.8**

The *DiagonalLayout* manager places the components in a diagonal in the container.

*DiagonalLayout* is similar to *FlowLayout*. *DiagonalLayout* arranges components along a diagonal using each component's natural *preferredSize*. It contains three constraints, *gap*, *lastFill*, and *majorDiagonal*, as shown in Figure 37.9. The source code for *DiagonalLayout* is given in Listing 37.4.



**Figure 37.9**

The *DiagonalLayout* manager has three properties with the supporting accessor and mutator methods.

**Listing 37.4 DiagonalLayout.java**

<margin note line 6: properties>

<margin note line 34: layout container>

```
1 import java.awt.*;
2
3 public class DiagonalLayout implements LayoutManager,
4 java.io.Serializable {
5 /** Vertical gap between the components */
6 private int gap = 10;
7
8 /** True if components are placed along the major diagonal */
9 private boolean majorDiagonal = true;
10
11 /** True if the last component is stretched to fill the space */
12 private boolean lastFill = false;
13
14 /** Constructor */
15 public DiagonalLayout() {
16 }
17
18 public void addLayoutComponent(String name, Component comp) {
19 // No need to implement it for DiagonalLayout
20 }
21
22 public void removeLayoutComponent(Component comp) {
23 // No need to implement it for DiagonalLayout
24 }
```

```

25
26 public Dimension preferredLayoutSize(Container parent) {
27 return minimumLayoutSize(parent);
28 }
29
30 public Dimension minimumLayoutSize(Container parent) {
31 return new Dimension(0, 0);
32 }
33
34 public void layoutContainer(Container parent) {
35 int numberOfComponents = parent.getComponentCount();
36
37 Insets insets = parent.getInsets();
38 int w = parent.getSize().width - insets.left - insets.right;
39 int h = parent.getSize().height - insets.bottom - insets.top;
40
41 if (majorDiagonal) {
42 int x = 10, y = 10;
43
44 for (int j = 0; j < numberOfComponents; j++) {
45 Component c = parent.getComponent(j);
46 Dimension d = c.getPreferredSize();
47
48 if (c.isVisible())
49 if (lastFill && (j == numberOfComponents - 1))
50 c.setBounds(x, y, w - x, h - y);
51 else
52 c.setBounds(x, y, d.width, d.height);
53 x += d.height + gap;
54 y += d.height + gap;
55 }
56 }
57 else { // It is subdiagonal
58 int x = w - 10, y = 10;
59
60 for (int j = 0; j < numberOfComponents; j++) {
61 Component c = parent.getComponent(j);
62 Dimension d = c.getPreferredSize();
63
64 if (c.isVisible())
65 if (lastFill & (j == numberOfComponents - 1))
66 c.setBounds(0, y, x, h - y);
67 else
68 c.setBounds(x - d.width, y, d.width, d.height);
69
70 x -= (d.height + gap);
71 y += d.height + gap;
72 }
73 }
74 }
75
76 public int getGap() {
77 return gap;
78 }
79
80 public void setGap(int gap) {
81 this.gap = gap;
82 }
83

```

```

84 public void setMajorDiagonal(boolean newMajorDiagonal) {
85 majorDiagonal = newMajorDiagonal;
86 }
87
88 public boolean isMajorDiagonal() {
89 return majorDiagonal;
90 }
91
92 public void setLastFill(boolean newLastFill) {
93 lastFill = newLastFill;
94 }
95
96 public boolean isLastFill() {
97 return lastFill;
98 }
99 }

```

The *DiagonalLayout* class implements the *LayoutManager* and *Serializable* interfaces (lines 3-4). The reason to implement *Serializable* is to make it a JavaBeans component.

The *Insets* class describes the size of the borders of a container. It contains the variables *left*, *right*, *bottom*, and *top*, which correspond to the measurements for the *left border*, *right border*, *top border*, and *bottom border* (lines 37-39).

The *Dimension* class used in *DiagonalLayout* encapsulates the width and height of a component in a single object. The class is associated with certain properties of components. Several methods defined by the *Component* class and the *LayoutManager* interface return a *Dimension* object.

Listing 37.5 gives a test program that uses *DiagonalLayout*.

#### Listing 37.5 ShowDiagonalLayout.java

<margin note line 9: diagonal layout>  
 <margin note line 27: create UI>  
 <margin note line 48: register listener>  
 <margin note line 55: register listener>  
 <margin note line 62: register listener>  
 <margin note line 70: main method omitted>

```

1 import javax.swing.*;
2 import javax.swing.border.*;
3 import java.awt.*;
4 import java.awt.event.*;
5
6 public class ShowDiagonalLayout extends JApplet {
7 private FlowLayout flowLayout = new FlowLayout();
8 private GridLayout gridLayout = new GridLayout(2, 2);
9 private DiagonalLayout diagonalLayout = new DiagonalLayout();
10
11 private JButton jbt1 = new JButton("Button 1");
12 private JButton jbt2 = new JButton("Button 2");
13 private JButton jbt3 = new JButton("Button 3");
14 private JButton jbt4 = new JButton("Button 4");
15
16 private JRadioButton jrbFlowLayout =

```



```

17 new JRadioButton("FlowLayout");
18 private JRadioButton jrbGridLayout =
19 new JRadioButton("GridLayout");
20 private JRadioButton jrbDiagonalLayout =
21 new JRadioButton("DiagonalLayout", true);
22
23 private JPanel jPanel2 = new JPanel();
24
25 public ShowDiagonalLayout() {
26 // Set default layout in jPanel2
27 jPanel2.setLayout(diagonalLayout);
28 jPanel2.add(jbt1);
29 jPanel2.add(jbt2);
30 jPanel2.add(jbt3);
31 jPanel2.add(jbt4);
32 jPanel2.setBorder(new LineBorder(Color.black));
33
34 JPanel jPanel1 = new JPanel();
35 jPanel1.setBorder(new TitledBorder("Select a Layout Manager"));
36 jPanel1.add(jrbFlowLayout);
37 jPanel1.add(jrbGridLayout);
38 jPanel1.add(jrbDiagonalLayout);
39
40 ButtonGroup buttonGroup1 = new ButtonGroup();
41 buttonGroup1.add(jrbFlowLayout);
42 buttonGroup1.add(jrbGridLayout);
43 buttonGroup1.add(jrbDiagonalLayout);
44
45 add(jPanel1, BorderLayout.SOUTH);
46 add(jPanel2, BorderLayout.CENTER);
47
48 jrbFlowLayout.addActionListener(new ActionListener() {
49 @Override
50 public void actionPerformed(ActionEvent e) {
51 jPanel2.setLayout(flowLayout);
52 jPanel2.validate();
53 }
54 });
55 jrbGridLayout.addActionListener(new ActionListener() {
56 @Override
57 public void actionPerformed(ActionEvent e) {
58 jPanel2.setLayout(gridLayout);
59 jPanel2.validate();
60 }
61 });
62 jrbDiagonalLayout.addActionListener(new ActionListener() {
63 @Override
64 public void actionPerformed(ActionEvent e) {
65 jPanel2.setLayout(diagonalLayout);
66 jPanel2.validate();
67 }
68 });
69 }
70 }

```

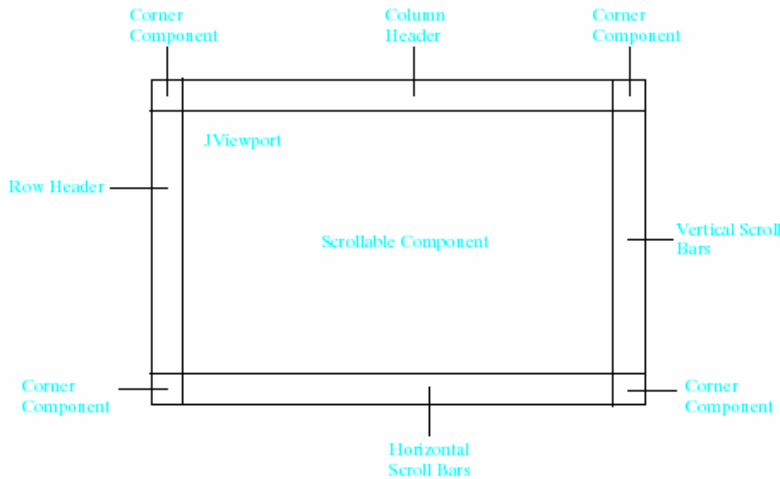
The `TestDiagonalLayout` class enables you to dynamically set the layout in `jPanel2`. When you select a new layout, the layout manager is set in `jPanel2`, and the `revalidate()` method is invoked (lines 52, 59, 66),

which in turn invokes the `layoutContainer` method in the `LayoutManager` interface to display the components in the container.

### 37.5 `JScrollPane`

Often you need to use a scroll bar to scroll the contents of an object that does not fit completely into the viewing area. `JScrollBar` and `JSlider` can be used for this purpose, but you have to manually write the code to implement scrolling with them. `JScrollPane` is a component that supports automatic scrolling without coding. It was used to scroll the text area in Listing 17.3, `TextAreaDemo.java`, and to scroll a list in Listing 17.5, `ListDemo.java`. In fact, it can be used to scroll any subclass of `JComponent`.

A `JScrollPane` can be viewed as a specialized container with a view port for displaying the contained component. In addition to horizontal and vertical scroll bars, a `JScrollPane` can have a column header, a row header, and corners, as shown in Figure 37.10.

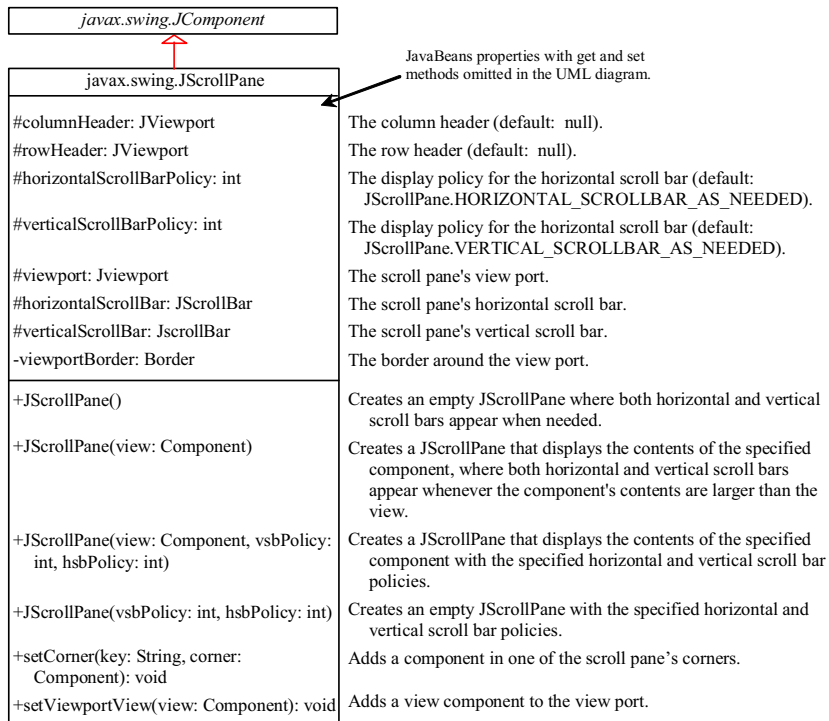


**Figure 37.10**

A `JScrollPane` has a view port, optional horizontal and vertical bars, optional column and row headers, and optional corners.

**<margin note: view port>**

The view port is an instance of `JViewport` through which a scrollable component is displayed. When you add a component to a scroll pane, you are actually placing it in the scroll pane's view port. Figure 37.11 shows the frequently used properties, constructors, and methods in `JScrollPane`.



**Figure 37.11**

*JScrollPane* provides methods for displaying and manipulating the components in a scroll pane.

The constructor always creates a view port regardless of whether the viewing component is specified. Normally, you have the component and you want to place it in a scroll pane. A convenient way to create a scroll pane for a component is to use the *JScrollPane(component)* constructor.

The *vsbPolicy* parameter can be one of the following three values:

`JScrollPane.VERTICAL_SCROLLBAR_AS_NEEDED`

`JScrollPane.VERTICAL_SCROLLBAR_NEVER`

`JScrollPane.VERTICAL_SCROLLBAR_ALWAYS`

The *hsbPolicy* parameter can be one of the following three values:

`JScrollPane.HORIZONTAL_SCROLLBAR_AS_NEEDED`

`JScrollPane.HORIZONTAL_SCROLLBAR_NEVER`

`JScrollPane.HORIZONTAL_SCROLLBAR_ALWAYS`

To set a corner component, you can use the `setCorner(String key, Component corner)` method. The legal values for the key are:

`JScrollPane.LOWER_LEFT_CORNER`

`JScrollPane.LOWER_RIGHT_CORNER`

`JScrollPane.UPPER_LEFT_CORNER`

`JScrollPane.UPPER_RIGHT_CORNER`

Listing 37.6 shows an example that displays a map in a label and places the label in a scroll pane so that a large map can be scrolled. The program lets you choose a map from a combo box and display it in the scroll pane, as shown in Figure 37.12.

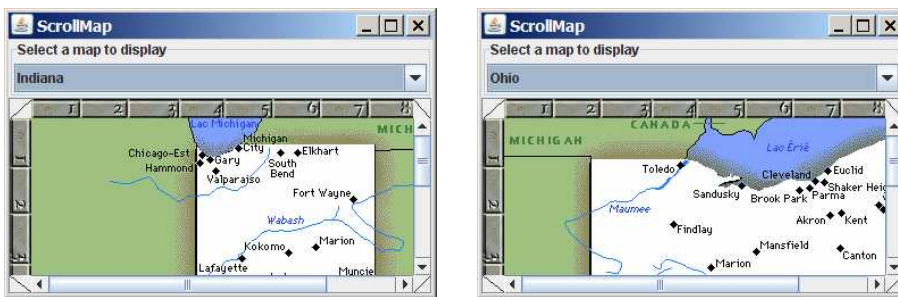


Figure 37.12

*The scroll pane can be used to scroll contents automatically.*

#### Listing 37.6 ScrollMap.java

```
<margin note line 8: labels>
<margin note line 17: create UI>
<margin note line 28: scroll pane>
<margin note line 46: register listener>
<margin note line 88: main method omitted >

1 import java.awt.*;
2 import java.awt.event.*;
3 import javax.swing.*;
4 import javax.swing.border.*;
5
6 public class ScrollMap extends JApplet {
7 // Create images in labels
8 private JLabel lblIndianaMap = new JLabel(
9 new ImageIcon(getClass().getResource("image/indianaMap.gif")));
10 private JLabel lblOhioMap = new JLabel(
11 new ImageIcon(getClass().getResource("/image/ohioMap.gif")));
12
13 // Create a scroll pane to scroll map in the labels
14 private JScrollPane jspMap = new JScrollPane(lblIndianaMap);
15
16 public ScrollMap() {
17 // Create a combo box for selecting maps
```

```

18 JComboBox jcboMap = new JComboBox(new String[]{"Indiana",
19 "Ohio"});
20
21 // Panel p to hold combo box
22 JPanel p = new JPanel();
23 p.setLayout(new BorderLayout());
24 p.add(jcboMap);
25 p.setBorder(new TitledBorder("Select a map to display"));
26
27 // Set row header, column header and corner header
28 jspMap.setColumnHeaderView(new JLabel(new ImageIcon(getClass().
29 getResource("/image/horizontalRuler.gif"))));
30 jspMap.setRowHeaderView(new JLabel(new ImageIcon(getClass().
31 getResource("/image/verticalRuler.gif"))));
32 jspMap.setCorner(JScrollPane.UPPER_LEFT_CORNER,
33 new CornerPanel(JScrollPane.UPPER_LEFT_CORNER));
34 jspMap.setCorner(ScrollPaneConstants.UPPER_RIGHT_CORNER,
35 new CornerPanel(JScrollPane.UPPER_RIGHT_CORNER));
36 jspMap.setCorner(JScrollPane.LOWER_RIGHT_CORNER,
37 new CornerPanel(JScrollPane.LOWER_RIGHT_CORNER));
38 jspMap.setCorner(JScrollPane.LOWER_LEFT_CORNER,
39 new CornerPanel(JScrollPane.LOWER_LEFT_CORNER));
40
41 // Add the scroll pane and combo box panel to the frame
42 add(jspMap, BorderLayout.CENTER);
43 add(p, BorderLayout.NORTH);
44
45 // Register listener
46 jcboMap.addItemListener(new ItemListener() {
47 /** Show the selected map */
48 public void itemStateChanged(ItemEvent e) {
49 String selectedItem = (String)e.getItem();
50 if (selectedItem.equals("Indiana")) {
51 // Set a new view in the view port
52 jspMap.setViewportView(lblIndianaMap);
53 }
54 else if (selectedItem.equals("Ohio")) {
55 // Set a new view in the view port
56 jspMap.setViewportView(lblOhioMap);
57 }
58
59 // Revalidate the scroll pane
60 jspMap.revalidate();
61 }
62 });
63 }
64
65 // A panel displaying a line used for scroll pane corner
66 class CornerPanel extends JPanel {
67 // Line location
68 private String location;
69
70 public CornerPanel(String location) {
71 this.location = location;
72 }
73
74 @Override /** Draw a line depending on the location */
75 protected void paintComponent(Graphics g) {
76 super.paintComponents(g);

```

```

77
78 if (location == "UPPER_LEFT_CORNER")
79 g.drawLine(0, getHeight(), getWidth(), 0);
80 else if (location == "UPPER_RIGHT_CORNER")
81 g.drawLine(0, 0, getWidth(), getHeight());
82 else if (location == "LOWER_RIGHT_CORNER")
83 g.drawLine(0, getHeight(), getWidth(), 0);
84 else if (location == "LOWER_LEFT_CORNER")
85 g.drawLine(0, 0, getWidth(), getHeight());
86 }
87 }
88 }

```

The program creates a scroll pane to view image maps. The images are created from image files and displayed in labels (lines 8-11). To view an image, the label that contains the image is placed in the scroll pane's view port (line 14).

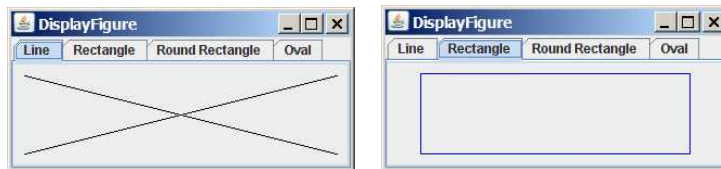
The scroll pane has a main view, a header view, a column view, and four corner views. Each view is a subclass of `Component`. Since `ImageIcon` is not a subclass of `Component`, it cannot be directly used as a view in the scroll pane. Instead the program places an `ImageIcon` to a label and uses the label as a view.

The `CornerPanel` (lines 66-87) is a subclass of `JPanel` that is used to display a line. How the line is drawn depends on the `location` of the corner. The `location` is a string passed in as a parameter in the `CornerPanel`'s constructor.

Whenever a new map is selected, the label for displaying the map image is set to the scroll pane's view port. The `revalidate()` method (line 60) must be invoked to cause the new image to be displayed. The `revalidate()` method causes a container to lay out its subcomponents again after the components it contains have been added to or modified.

### 37.6 `JTabbedPane`

`JTabbedPane` is a useful Swing container that provides a set of mutually exclusive tabs for accessing multiple components, as shown in Figure 37.13.



**Figure 37.13**

`JTabbedPane` displays components through the tabs.

Usually you place the panels inside a `JTabbedPane` and associate a tab with each panel. `JTabbedPane` is easy to use, because the selection of the panel is handled automatically by clicking the corresponding tab. You can switch between a group of panels by clicking on a tab with a

given title and/or icon. Figure 37.14 shows the frequently used properties, constructors, and methods in *JTabbedPane*.

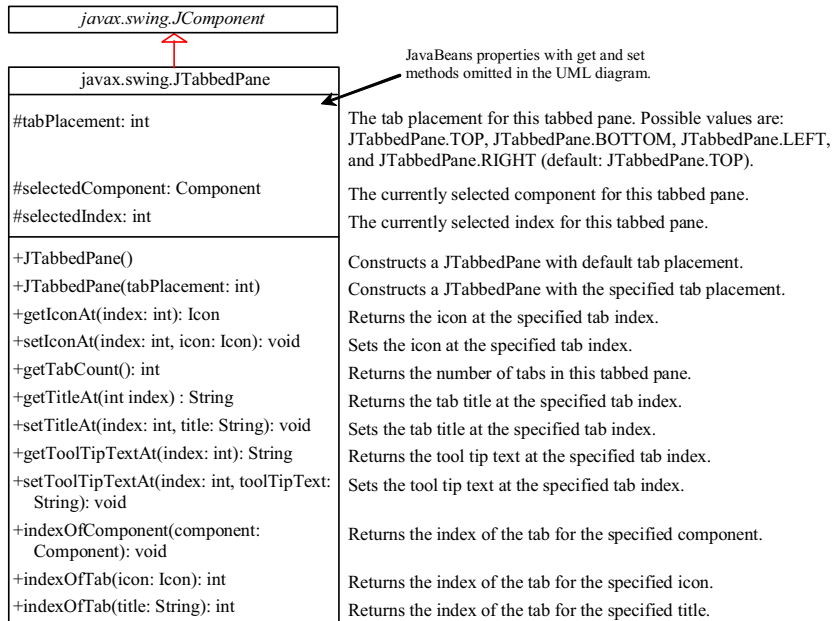


Figure 37.14

*JTabbedPane* provides methods for displaying and manipulating the components in the tabbed pane.

Listing 37.7 gives an example that uses a tabbed pane with four tabs to display four types of figures: line, rectangle, rounded rectangle, and oval. You can select a figure to display by clicking the corresponding tab, as shown in Figure 37.13. The *FigurePanel* class for displaying a figure was presented in Listing 15.3, *FigurePanel.java*. You can use the *type* property to specify a figure type.

#### Listing 37.7 DisplayFigure.java

```

<margin note line 5: tabbed pane>
<margin note line 12: set type>
<margin note line 18: add tabs>
<margin note line 23: set tool tips>
<margin note line 28: main method omitted>

1 import java.awt.*;
2 import javax.swing.*;
3
4 public class DisplayFigure extends JApplet {
5 private JTabbedPane jtpFigures = new JTabbedPane();
6 private FigurePanel squarePanel = new FigurePanel();
7 private FigurePanel rectanglePanel = new FigurePanel();
8 private FigurePanel circlePanel = new FigurePanel();
9 private FigurePanel ovalPanel = new FigurePanel();
10

```

```

11 public DisplayFigure() {
12 squarePanel.setType(FigurePanel.LINE);
13 rectanglePanel.setType(FigurePanel.RECTANGLE);
14 circlePanel.setType(FigurePanel.ROUND_RECTANGLE);
15 ovalPanel.setType(FigurePanel.OVAL);
16
17 add(jtpFigures, BorderLayout.CENTER);
18 jtpFigures.add(squarePanel, "Line");
19 jtpFigures.add(rectanglePanel, "Rectangle");
20 jtpFigures.add(circlePanel, "Round Rectangle");
21 jtpFigures.add(ovalPanel, "Oval");
22
23 jtpFigures.setToolTipTextAt(0, "Square");
24 jtpFigures.setToolTipTextAt(1, "Rectangle");
25 jtpFigures.setToolTipTextAt(2, "Circle");
26 jtpFigures.setToolTipTextAt(3, "Oval");
27 }
28 }

```

The program creates a tabbed pane to hold four panels, each of which displays a figure. A panel is associated with a tab. The tabs are titled Line, Rectangle, Rounded Rectangle, and Oval.

By default, the tabs are placed at the top of the tabbed pane. You can select a different placement using the `tabPlacement` property.

### 37.7 JSplitPane

`JSplitPane` is a convenient Swing container that contains two components with a separate bar known as a *divider*, as shown in Figure 37.15.

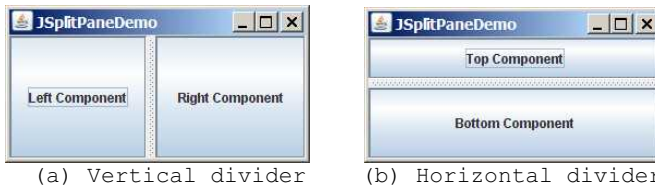


Figure 37.15

`JSplitPane` divides a container into two parts.

The bar can divide the container horizontally or vertically and can be dragged to change the amount of space occupied by each component.

Figure 37.16 shows the frequently used properties, constructors, and methods in `JSplitPane`.



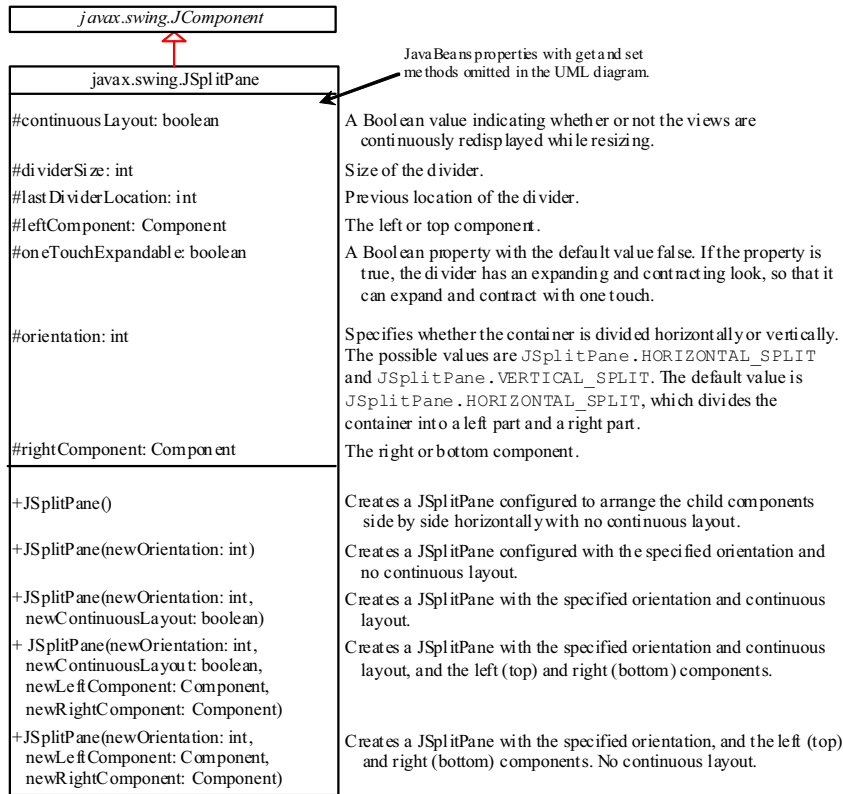


Figure 37.16

*JSplitPane* provides methods to specify the properties of a split pane and for manipulating the components in a split pane.

Listing 37.8 gives an example that uses radio buttons to let the user select a **FlowLayout**, **GridLayout**, or **BoxLayout** manager dynamically for a panel. The panel contains four buttons, as shown in Figure 37.17. The description of the currently selected layout manager is displayed in a text area. The radio buttons, buttons, and text area are placed in two split panes.

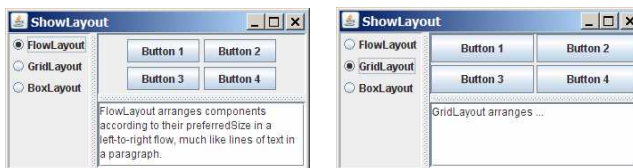


Figure 37.17

You can adjust the component size in the split panes.

**Listing 37.8 ShowLayout.java**

<margin note line 7: descriptions>

<margin note line 13: radio buttons>  
 <margin note line 24: layout managers>  
 <margin note line 54: split pane>  
 <margin note line 57: split pane>  
 <margin note line 76: register listener>  
 <margin note line 81: validate>  
 <margin note line 84: register listener>  
 <margin note line 89: validate>  
 <margin note line 93: main method omitted>

```

1 import java.awt.*;
2 import java.awt.event.*;
3 import javax.swing.*;
4
5 public class ShowLayout extends JApplet {
6 // Get the url for HTML files
7 private String flowLayoutDesc = "FlowLayout arranges components " +
8 "according to their preferredSize in " +
9 "a left-to-right flow, much like lines of text in a paragraph.";
10 private String gridLayoutDesc = "GridLayout arranges ...";
11 private String boxLayoutDesc = "BoxLayout arranges ...";
12
13 private JRadioButton jrbFlowLayout =
14 new JRadioButton("FlowLayout");
15 private JRadioButton jrbGridLayout =
16 new JRadioButton("GridLayout", true);
17 private JRadioButton jrbBoxLayout =
18 new JRadioButton("BoxLayout");
19
20 private JPanel jpComponents = new JPanel();
21 private JTextArea jtfDescription = new JTextArea();
22
23 // Create layout managers
24 private FlowLayout flowLayout = new FlowLayout();
25 private GridLayout gridLayout = new GridLayout(2, 2, 3, 3);
26 private BoxLayout boxLayout =
27 new BoxLayout(jpComponents, BoxLayout.X_AXIS);
28
29 public ShowLayout() {
30 // Create a box to hold radio buttons
31 Box jpChooseLayout = Box.createVerticalBox();
32 jpChooseLayout.add(jrbFlowLayout);
33 jpChooseLayout.add(jrbGridLayout);
34 jpChooseLayout.add(jrbBoxLayout);
35
36 // Group radio buttons
37 ButtonGroup btg = new ButtonGroup();
38 btg.add(jrbFlowLayout);
39 btg.add(jrbGridLayout);
40 btg.add(jrbBoxLayout);
41
42 // Wrap lines and words
43 jtfDescription.setLineWrap(true);
44 jtfDescription.setWrapStyleWord(true);
45
46 // Add four buttons to jpComponents
47 jpComponents.add(new JButton("Button 1"));
48 jpComponents.add(new JButton("Button 2"));
49 jpComponents.add(new JButton("Button 3"));

```

```

50 jpComponents.add(new JButton("Button 4"));
51
52 // Create two split panes to hold jpChooseLayout, jpComponents,
53 // and jtfDescription
54 JSplitPane jSplitPane2 = new JSplitPane(
55 JSplitPane.VERTICAL_SPLIT, jpComponents,
56 new JScrollPane(jtfDescription));
57 JSplitPane jSplitPanel1 = new JSplitPane(
58 JSplitPane.HORIZONTAL_SPLIT, jpChooseLayout, jSplitPane2);
59
60 // Set FlowLayout as default
61 jpComponents.setLayout(flowLayout);
62 jpComponents.revalidate();
63 jtfDescription.setText(flowLayoutDesc);
64
65 add(jSplitPanel1, BorderLayout.CENTER);
66
67 // Register listeners
68 jrbFlowLayout.addActionListener(new ActionListener() {
69 @Override
70 public void actionPerformed(ActionEvent e) {
71 jpComponents.setLayout(flowLayout);
72 jtfDescription.setText(flowLayoutDesc);
73 jpComponents.revalidate();
74 }
75 });
76 jrbGridLayout.addActionListener(new ActionListener() {
77 @Override
78 public void actionPerformed(ActionEvent e) {
79 jpComponents.setLayout(gridLayout);
80 jtfDescription.setText(gridLayoutDesc);
81 jpComponents.revalidate();
82 }
83 });
84 jrbBoxLayout.addActionListener(new ActionListener() {
85 @Override
86 public void actionPerformed(ActionEvent e) {
87 jpComponents.setLayout(boxLayout);
88 jtfDescription.setText(boxLayoutDesc);
89 jpComponents.revalidate();
90 }
91 });
92 }
93 }

```

Split panes can be embedded. Adding a split pane to an existing split pane results in three split panes. The program creates two split panes (lines 54-58) to hold a panel for radio buttons, a panel for buttons, and a scroll pane.

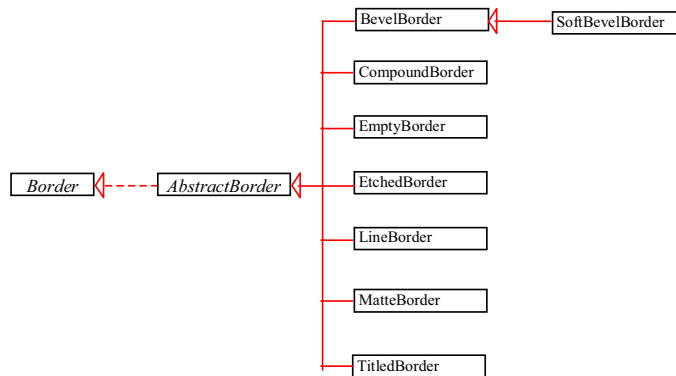
The radio buttons are used to select layout managers. A selected layout manager is used in the panel for laying out the buttons (lines 66-88). The scroll pane contains a [JTextArea](#) for displaying the text that describes the selected layout manager (line 56).

### 37.8 Swing Borders

Swing provides a variety of borders that you can use to decorate components. You learned how to create titled borders and line borders

in §12.9, “Common Features of Swing GUI Components.” This section introduces borders in more detail.

A Swing border is defined in the `Border` interface. Every instance of `JComponent` can set a border through the `border` property defined in `JComponent`. If a border is present, it replaces the inset. The `AbstractBorder` class implements an empty border with no size. This provides a convenient base class from which other border classes can easily be defined. There are eight concrete border classes, `BevelBorder`, `SoftBevelBorder`, `CompoundBorder`, `EmptyBorder`, `EtchedBorder`, `LineBorder`, `MatteBorder`, and `TitledBorder`, as shown in Figure 37.18.



**Figure 37.18**

The `Border` interface defines Swing borders.

[BL]`BevelBorder` is a 3D-look border that can be lowered or raised. `BevelBorder` has the following constructors, which create a `BevelBorder` with the specified `bevelType` (`BevelBorder.LOWERED` or `BevelBorder.RAISED`) and colors:

```

BevelBorder(int bevelType)
BevelBorder(int bevelType, Color highlight, Color shadow)
BevelBorder(int bevelType, Color highlightOuterColor,
 Color highlightInnerColor,
 Color shadowOuterColor, Color shadowInnerColor)

```

[BL]`SoftBevelBorder` is a raised or lowered bevel with softened corners. `SoftBevelBorder` has the following constructors:

```

SoftBevelBorder(int bevelType)
SoftBevelBorder(int bevelType, Color highlight, Color shadow)
SoftBevelBorder(int bevelType, Color highlightOuterColor,
 Color highlightInnerColor, Color shadowOuterColor,
 Color shadowInnerColor)

```

[BL]`EmptyBorder` is a border with border space but no drawings. `EmptyBorder` has the following constructors:

```

EmptyBorder(Insets borderInsets)
EmptyBorder(int top, int left, int bottom, int right)

```

[BL]**EtchedBorder** is an etched border that can be etched-in or etched-out. **EtchedBorder** has the property **etchType** with the value **LOWERED** or **RAISED**. **EtchedBorder** has the following constructors:

```
EtchedBorder() // Default constructor with a lowered border
EtchedBorder(Color highlight, Color shadow)
EtchedBorder(int etchType)
EtchedBorder(int etchType, Color highlight, Color shadow)
```

[BL]**LineBorder** draws a line of arbitrary thickness and a single color around the border. **LineBorder** has the following constructors:

```
LineBorder(Color color) // Thickness 1
LineBorder(Color color, int thickness)
LineBorder(Color color, int thickness, boolean roundedCorners)
```

[BL]**MatteBorder** is a mattelike border padded with the icon images. **MatteBorder** has the following constructors:

```
MatteBorder(Icon tileIcon)
MatteBorder(Insets borderInsets, Color matteColor)
MatteBorder(Insets borderInsets, Icon tileIcon)
MatteBorder(int top, int left, int bottom,
 int right, Color matteColor)
MatteBorder(int top, int left, int bottom, int right, Icon tileIcon)
```

[BL]**CompoundBorder** is used to compose two **Border** objects into a single border by nesting an inside **Border** object within the insets of an outside **Border** object using the following constructor:

```
CompoundBorder(Border outsideBorder, Border insideBorder)
```

[BL]**TitledBorder** is a border with a string title in a specified position. **TitledBorder** can be composed with other borders. **TitledBorder** has the following constructors:

```
TitledBorder(String title)
TitledBorder(Border border) // Empty title on another border
TitledBorder(Border border, String title)
TitledBorder(Border border, String title,
 int titleJustification, int titlePosition)
TitledBorder(Border border, String title,
 int titleJustification, int titlePosition,
 Font titleFont)
TitledBorder(Border border, String title,
 int titleJustification, int titlePosition,
 Font titleFont, Color titleColor)
```

For convenience, Java also provides the **javax.swing.BorderFactory** class, which contains the static methods for creating borders shown in Figure 37.19.

javax.swing.BorderFactory
+createBevelBorder(type: int): Border
+createBevelBorder(type: int, highlight: Color, shadow: Color): Border
+createBevelBorder(type: int, highlightOuter: Color, highlightInner: Color, shadowOuter: Color, shadowInner: Color): Border
+createCompoundBorder(): CompoundBorder
+createCompoundBorder(outsideBorder: Border, insideBorder: Border): CompoundBorder
+createEmptyBorder(): Border
+createEmptyBorder(top: int, left: int, bottom: int, right: int): Border
+createEtchedBorder(): Border
+createEtchedBorder(highlight: Color, shadow: Color): Border
+createEtchedBorder(type: int): Border
+createEtchedBorder(type: int, highlight: Color, shadow: Color): Border
+createLineBorder(color: Color): Border
+createLineBorder(color: Color, thickness: int): Border
+createLoweredBevelBorder(): Border
+createMatteBorder(top: int, left: int, bottom: int, right: int, color: Color): MatteBorder
+createMatteBorder(top: int, left: int, bottom: int, right: int, tileIcon: Icon): MatteBorder
+createRaisedBevelBorder(): Border
+createTitledBorder(border: Border): TitledBorder
+createTitledBorder(border: Border, title: String): TitledBorder
+createTitledBorder(border: Border, title: String, titleJustification: int, titlePosition: int): TitledBorder
+createTitledBorder(border: Border, title: String, titleJustification: int, titlePosition: int, titleFont: Font): TitledBorder
+createTitledBorder(border: Border, title: String, titleJustification: int, titlePosition: int, titleFont: Font, titleColor: Color): TitledBorder
+createTitledBorder(title: String): TitledBorder

**Figure 37.19**

*BorderFactory* contains the static methods for creating various types of borders.

For example, to create an etched border, use the following statement:

```
Border border = BorderFactory.createEtchedBorder();
```

**NOTE**

All the border classes and interfaces are grouped in the package `javax.swing.border` except `javax.swing.BorderFactory`.

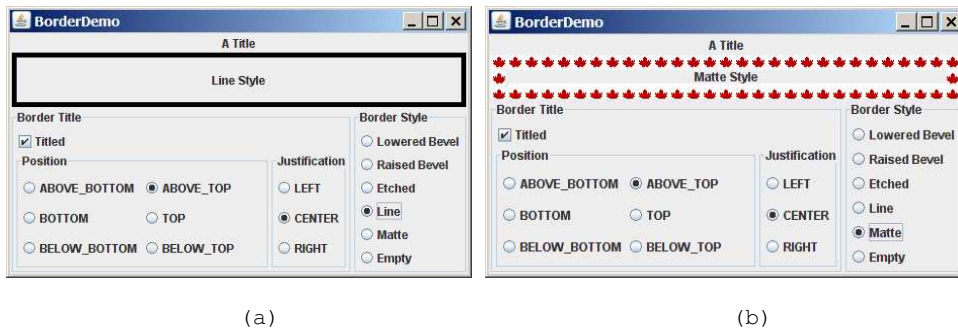
**NOTE**

Borders and icons can be shared. Thus you can create a border or icon and use it to set the `border` or `icon` property for any GUI component. For example, the following statements set a border `b` for two panels `p1` and `p2`:

```
p1.setBorder(b);
p2.setBorder(b);
```

*\*\*\*End of NOTE*

Listing 37.9 gives an example that creates and displays various types of borders. You can select a border with or without a title. For a border without a title, you can choose a border style from Lowered Bevel, Raised Bevel, Etched, Line, Matte, or Empty. For a border with a title, you can specify the title position and justification. You can also embed another border into a titled border. Figure 37.20 displays a sample run of the program.



**Figure 37.20**

*The program demonstrates various types of borders.*

Here are the major steps in the program:

1. Create the user interface.
  - a. Create a `JLabel` object and place it in the center of the frame.
  - b. Create a panel named `jpPosition` to group the radio buttons for selecting the border title position. Set the border of this panel in the titled border with the title "Position".
  - c. Create a panel named `jpJustification` to group the radio buttons for selecting the border title justification. Set the border of this panel in the titled border with the title "Justification".
  - d. Create a panel named `jpTitleOptions` to hold the `jpPosition` panel and the `jpJustification` panel.
  - e. Create a panel named `jpTitle` to hold a check box named "Titled" and the `jpTitleOptions` panel.
  - f. Create a panel named `jpBorderStyle` to group the radio buttons for selecting border styles.
  - a. Create a panel named `jpAllChoices` to hold the panels `jpTitle` and `jpBorderStyle`. Place `jpAllChoices` in the south of the frame.
2. Process the event.

Create and register listeners to implement the `actionPerformed` handler to set the border for the label according to the events from the check box, and from all the radio buttons.

#### Listing 37.9 BorderDemo.java

```
<margin note line 30: create UI>
<margin note line 142: empty border>
<margin note line 145: bevel border>
<margin note line 149: bevel border>
<margin note line 153: etched border>
<margin note line 157: line border>
<margin note line 161: matte border>
<margin note line 167: empty border>
<margin note line 197: border on border>
<margin note line 207: main method omitted>

1 import java.awt.*;
2 import java.awt.event.ActionListener;
3 import java.awt.event.ActionEvent;
4 import javax.swing.*;
5 import javax.swing.border.*;
6
7 public class BorderDemo extends JApplet {
8 // Declare a label for displaying message
9 private JLabel jLabel1 = new JLabel("Display the border type",
10 JLabel.CENTER);
11
12 // A check box for selecting a border with or without a title
13 private JCheckBox jchkTitled;
14
15 // Radio buttons for border styles
16 private JRadioButton jrbLoweredBevel, jrbRaisedBevel,
17 jrbEtched, jrbLine, jrbMatte, jrbEmpty;
18
19 // Radio buttons for titled border options
20 private JRadioButton jrbAboveBottom, jrbBottom,
21 jrbBelowBottom, jrbAboveTop, jrbTop, jrbBelowTop,
22 jrbLeft, jrbCenter, jrbRight;
23
24 // TitledBorder for the label
25 private TitledBorder jLabel1Border;
26
27 /** Constructor */
28 public BorderDemo() {
29 // Create a JLabel instance and set colors
30 jLabel1.setBackground(Color.yellow);
31 jLabel1.setBorder(jLabel1Border);
32
33 // Place title position radio buttons
34 JPanel jpPosition = new JPanel();
35 jpPosition.setLayout(new GridLayout(3, 2));
36 jpPosition.add(
37 jrbAboveBottom = new JRadioButton("ABOVE_BOTTOM"));
38 jpPosition.add(jrbAboveTop = new JRadioButton("ABOVE_TOP"));
39 jpPosition.add(jrbBottom = new JRadioButton("BOTTOM"));
40 jpPosition.add(jrbTop = new JRadioButton("TOP"));
41 jpPosition.add(
42 jrbBelowBottom = new JRadioButton("BELOW_BOTTOM"));

```



```

43 jpPosition.add(jrbBelowTop = new JRadioButton("BELOW_TOP"));
44 jpPosition.setBorder(new TitledBorder("Position"));
45
46 // Place title justification radio buttons
47 JPanel jpJustification = new JPanel();
48 jpJustification.setLayout(new GridLayout(3,1));
49 jpJustification.add(jrbLeft = new JRadioButton("LEFT"));
50 jpJustification.add(jrbCenter = new JRadioButton("CENTER"));
51 jpJustification.add(jrbRight = new JRadioButton("RIGHT"));
52 jpJustification.setBorder(new TitledBorder("Justification"));
53
54 // Create panel jpTitleOptions to hold jpPosition and
55 // jpJustification
56 JPanel jpTitleOptions = new JPanel();
57 jpTitleOptions.setLayout(new BorderLayout());
58 jpTitleOptions.add(jpPosition, BorderLayout.CENTER);
59 jpTitleOptions.add(jpJustification, BorderLayout.EAST);
60
61 // Create Panel jpTitle to hold a check box and title position
62 // radio buttons, and title justification radio buttons
63 JPanel jpTitle = new JPanel();
64 jpTitle.setBorder(new TitledBorder("Border Title"));
65 jpTitle.setLayout(new BorderLayout());
66 jpTitle.add(jchkTitled = new JCheckBox("Titled"),
67 BorderLayout.NORTH);
68 jpTitle.add(jpTitleOptions, BorderLayout.CENTER);
69
70 // Group radio buttons for title position
71 ButtonGroup btgTitlePosition = new ButtonGroup();
72 btgTitlePosition.add(jrbAboveBottom);
73 btgTitlePosition.add(jrbBottom);
74 btgTitlePosition.add(jrbBelowBottom);
75 btgTitlePosition.add(jrbAboveTop);
76 btgTitlePosition.add(jrbTop);
77 btgTitlePosition.add(jrbBelowTop);
78
79 // Group radio buttons for title justification
80 ButtonGroup btgTitleJustification = new ButtonGroup();
81 btgTitleJustification.add(jrbLeft);
82 btgTitleJustification.add(jrbCenter);
83 btgTitleJustification.add(jrbRight);
84
85 // Create Panel jpBorderStyle to hold border style radio buttons
86 JPanel jpBorderStyle = new JPanel();
87 jpBorderStyle.setBorder(new TitledBorder("Border Style"));
88 jpBorderStyle.setLayout(new GridLayout(6, 1));
89 jpBorderStyle.add(jrbLoweredBevel =
90 new JRadioButton("Lowered Bevel"));
91 jpBorderStyle.add(jrbRaisedBevel =
92 new JRadioButton("Raised Bevel"));
93 jpBorderStyle.add(jrbEtched = new JRadioButton("Etched"));
94 jpBorderStyle.add(jrbLine = new JRadioButton("Line"));
95 jpBorderStyle.add(jrbMatte = new JRadioButton("Matte"));
96 jpBorderStyle.add(jrbEmpty = new JRadioButton("Empty"));
97
98 // Group radio buttons for border styles
99 ButtonGroup btgBorderStyle = new ButtonGroup();
100 btgBorderStyle.add(jrbLoweredBevel);
101 btgBorderStyle.add(jrbRaisedBevel);

```

```

102 btgBorderStyle.add(jrbEtched);
103 btgBorderStyle.add(jrbLine);
104 btgBorderStyle.add(jrbMatte);
105 btgBorderStyle.add(jrbEmpty);
106
107 // Create Panel jpAllChoices to place jpTitle and jpBorderStyle
108 JPanel jpAllChoices = new JPanel();
109 jpAllChoices.setLayout(new BorderLayout());
110 jpAllChoices.add(jpTitle, BorderLayout.CENTER);
111 jpAllChoices.add(jpBorderStyle, BorderLayout.EAST);
112
113 // Place panels in the frame
114 setLayout(new BorderLayout());
115 add(jLabell, BorderLayout.CENTER);
116 add(jpAllChoices, BorderLayout.SOUTH);
117
118 // Register listeners
119 ActionListener listener = new ActionListener();
120 jchkTitled.addActionListener(listener);
121 jrbAboveBottom.addActionListener(listener);
122 jrbBottom.addActionListener(listener);
123 jrbBelowBottom.addActionListener(listener);
124 jrbAboveTop.addActionListener(listener);
125 jrbTop.addActionListener(listener);
126 jrbBelowTop.addActionListener(listener);
127 jrbLeft.addActionListener(listener);
128 jrbCenter.addActionListener(listener);
129 jrbRight.addActionListener(listener);
130 jrbLoweredBevel.addActionListener(listener);
131 jrbRaisedBevel.addActionListener(listener);
132 jrbLine.addActionListener(listener);
133 jrbEtched.addActionListener(listener);
134 jrbMatte.addActionListener(listener);
135 jrbEmpty.addActionListener(listener);
136 }
137
138 private class EventListener implements ActionListener {
139 @Override /** Handle ActionEvents on check box and radio buttons */
140 public void actionPerformed(ActionEvent e) {
141 // Get border style
142 Border border = new EmptyBorder(2, 2, 2, 2);
143
144 if (jrbLoweredBevel.isSelected()) {
145 border = new BevelBorder(BevelBorder.LOWERED);
146 jLabell.setText("Lowered Bevel Style");
147 }
148 else if (jrbRaisedBevel.isSelected()) {
149 border = new BevelBorder(BevelBorder.RAISED);
150 jLabell.setText("Raised Bevel Style");
151 }
152 else if (jrbEtched.isSelected()) {
153 border = new EtchedBorder();
154 jLabell.setText("Etched Style");
155 }
156 else if (jrbLine.isSelected()) {
157 border = new LineBorder(Color.black, 5);
158 jLabell.setText("Line Style");
159 }
160 else if (jrbMatte.isSelected()) {

```

```

161 border = new MatteBorder(15, 15, 15, 15,
162 new ImageIcon(getClass().getResource
163 ("/image/caIcon.gif")));
164 jLabell.setText("Matte Style");
165 }
166 else if (jrbEmpty.isSelected()) {
167 border = new EmptyBorder(2, 2, 2, 2);
168 jLabell.setText("Empty Style");
169 }
170
171 if (jchkTitled.isSelected()) {
172 // Get the title position and justification
173 int titlePosition = TitledBorder.DEFAULT_POSITION;
174 int titleJustification = TitledBorder.DEFAULT_JUSTIFICATION;
175
176 if (jrbAboveBottom.isSelected())
177 titlePosition = TitledBorder.ABOVE_BOTTOM;
178 else if (jrbBottom.isSelected())
179 titlePosition = TitledBorder.BOTTOM;
180 else if (jrbBelowBottom.isSelected())
181 titlePosition = TitledBorder.BELOW_BOTTOM;
182 else if (jrbAboveTop.isSelected())
183 titlePosition = TitledBorder.ABOVE_TOP;
184 else if (jrbTop.isSelected())
185 titlePosition = TitledBorder.TOP;
186 else if (jrbBelowTop.isSelected())
187 titlePosition = TitledBorder.BELOW_TOP;
188
189 if (jrbLeft.isSelected())
190 titleJustification = TitledBorder.LEFT;
191 else if (jrbCenter.isSelected())
192 titleJustification = TitledBorder.CENTER;
193 else if (jrbRight.isSelected())
194 titleJustification = TitledBorder.RIGHT;
195
196 jLabellBorder = new TitledBorder("A Title");
197 jLabellBorder.setBorder(border);
198 jLabellBorder.setTitlePosition(titlePosition);
199 jLabellBorder.setTitleJustification(titleJustification);
200 jLabell.setBorder(jLabellBorder);
201 }
202 else {
203 jLabell.setBorder(border);
204 }
205 }
206 }
207 }

```

This example uses many panels to group UI components to achieve the desired look. Figure 37.20 illustrates the relationship of the panels. The Border Title panel groups all the options for setting title properties. The position options are grouped in the Position panel. The justification options are grouped in the Justification panel. The Border Style panel groups the radio buttons for choosing Lowered Bevel, Raised Bevel, Etched, Line, Matte, and Empty borders.

The label displays the selected border with or without a title, depending on the selection of the title check box. The label also displays a text indicating which type of border is being used,

depending on the selection of the radio button in the Border Style panel.

The `TitledBorder` can be mixed with other borders. To do so, simply create an instance of `TitledBorder`, and use the `setBorder` method to embed a new border in `TitledBorder`.

The `MatteBorder` can be used to display icons on the border, as shown in Figure 37.20b.

## Chapter Summary

1. `javax.swing.JRootPane` is a lightweight container used behind the scenes by Swing's top-level containers, such as `JFrame`, `JApplet`, and `JDialog`. `javax.swing.JLayeredPane` is a container that manages the optional menu bar and the content pane. The content pane is an instance of `Container`. By default, it is a `JPanel` with `BorderLayout`. This is the container where the user interface components are added. To obtain the content pane in a `JFrame` or in a `JApplet`, use the `getContentPane()` method. You can set any instance of `Container` to be a new content pane using the `setContentPane` method.
2. Every container has a layout manager that is responsible for arranging its components. The container's `setLayout` method can be used to set a layout manager. Certain types of containers have default layout managers.
3. The layout manager places the components in accordance with its own rules and property settings, and with the constraints associated with each component. Every layout manager has its own specific set of rules. Some layout managers have properties that can affect the sizing and location of the components in the container.
4. Java also supports absolute layout, which enables you to place components at fixed locations. In this case, the component must be placed using the component's instance method `setBounds()` (defined in `java.awt.Component`). Absolute positions and sizes are fine if the application is developed and deployed on the same platform, but what looks fine on a development system may not look right on a deployment system on a different platform. To solve this problem, Java provides a set of layout managers that place components in containers in a way that is independent of fonts, screen resolutions, and operating systems.
5. In addition to the layout managers provided in Java, you can create custom layout managers by implementing the `LayoutManager` interface.
6. Java provides specialized containers `Box`, `JScrollPane`, `JTabbedPane`, and `JSplitPane` with fixed layout managers.
7. A Swing border is defined in the `Border` interface. Every instance of `JComponent` can set a border through the `border` property defined in `JComponent`. If a border is present, it replaces the inset. There are eight concrete border classes: `BevelBorder`, `SoftBevelBorder`, `CompoundBorder`, `EmptyBorder`, `EtchedBorder`, `LineBorder`, `MatteBorder`, and `TitledBorder`. You can use the constructors of these classes or the static methods in `javax.swing.BorderFactory` to create borders.

## Test Questions

Do the test questions for this chapter online at  
[www.cs.armstrong.edu/liang/intro9e/test.html](http://www.cs.armstrong.edu/liang/intro9e/test.html).

## Review Questions

### Section 37.2

37.1 Since `JButton` is a subclass of `Container`, can you add a button inside a button?

37.2 How do you set an image icon in a `JFrame`'s title bar? Can you set an image icon in a `JApplet`'s title bar?

37.3 Which of the following are the properties in `JFrame`, `JApplet`, and `JPanel`?

`contentPane`, `iconImage`, `jMenuBar`, `resizable`, `title`

### Section 37.3

37.4 How does the layout in Java differ from those in Visual Basic?

37.5 Discuss the factors that determine the size of the components in a container.

37.6 Discuss the properties `preferredSize`, `minimumSize`, and `maximumSize`.

37.7 Discuss the properties `alignmentX` and `alignmentY`.

37.8 What is a `CardLayout` manager? How do you create a `CardLayout` manager?

37.9 Can you use absolute positioning in Java? How do you use absolute positioning? Why should you avoid using it?

37.10 What is `BoxLayout`? How do you use `BoxLayout`? How do you use fillers to separate the components?

### Sections 37.4-37.7

37.11 How do you create a custom layout manager?

37.12 What is `JScrollPane`? How do you use `JScrollPane`?

37.13 What is `JTabbedPane`? How do you use `JTabbedPane`?

37.14 What is `JSplitPane`? How do you use `JSplitPane`?

37.15 Can you specify a layout manager in `Box`, `JScrollPane`, `JTabbedPane`, and `JSplitPane`?

### Section 37.8 Swing Borders

37.16 How do you create a titled border, a line border, a bevel border, and an etched border?

37.17 Can you set a border for every Swing GUI component? Can a border object be shared by different GUI components?

37.18 What package contains `Border`, `BevelBorder`, `CompoundBorder`, `EmptyBorder`, `EtchedBorder`, `LineBorder`, `MatteBorder`, `TitledBorder`, and `BorderFactory`?

## Programming Exercises

### Section 37.3

- 37.1\* (Demonstrate **FlowLayout** properties) Create a program that enables the user to set the properties of a **FlowLayout** manager dynamically, as shown in Figure 37.21. The **FlowLayout** manager is used to place 15 components in a panel. You can set the **alignment**, **hgap**, and **vgap** properties of the **FlowLayout** dynamically.

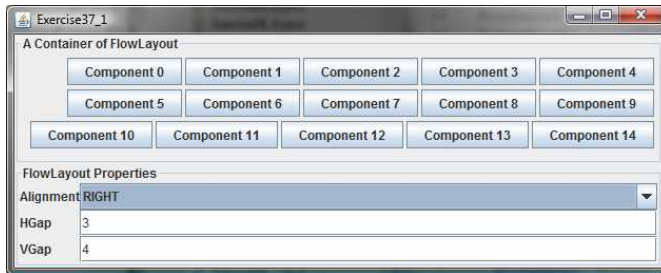
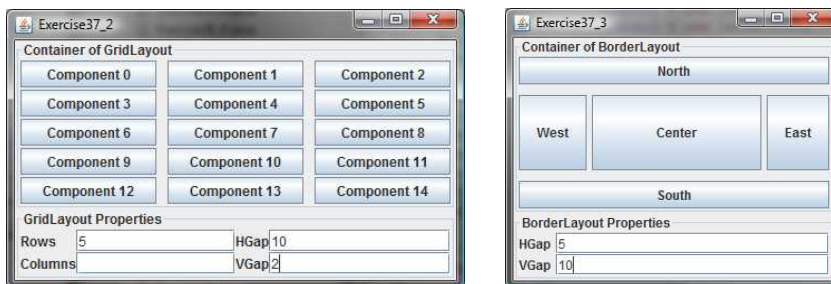


Figure 37.21

The program enables you to set the properties of a **FlowLayout** manager dynamically.

- 37.2\* (Demonstrate **GridLayout** properties) Create a program that enables the user to set the properties of a **GridLayout** manager dynamically, as shown in Figure 37.22a. The **GridLayout** manager is used to place 15 components in a panel. You can set the **rows**, **columns**, **hgap**, and **vgap** properties of the **GridLayout** dynamically.



(a)

(b)

Figure 37.22

(a) The program enables you to set the properties of a **GridLayout** manager dynamically. (b) The program enables you to set the properties of a **BorderLayout** manager dynamically.

- 37.3\* (Demonstrate **BorderLayout** properties) Create a program that enables the user to set the properties of a **BorderLayout** manager dynamically, as shown in Figure 37.22b. The **BorderLayout** manager is used to place five components in a panel. You can set the **hgap** and **vgap** properties of the **BorderLayout** dynamically.

37.4\* (Use [CardLayout](#)) Write an applet that does arithmetic on integers and rationals. The program uses two panels in a [CardLayout](#) manager, one for integer arithmetic and the other for rational arithmetic. The program provides a combo box with two items Integer and Rational. When the user chooses the Integer item, the integer panel is activated. When the user chooses the Rational item, the rational panel is activated (see Figure 37.23).

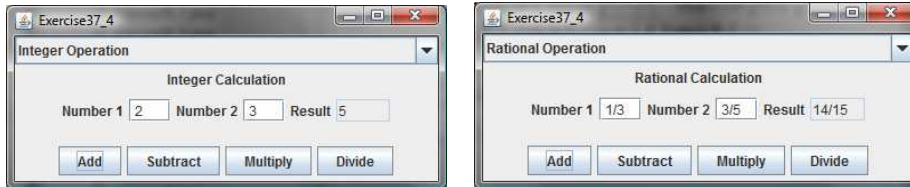


Figure 37.23

[CardLayout](#) is used to select panels that perform integer operations and rational number operations.

37.5\* (Use [null layout](#)) Use absolute layout to lay out a calculator, as shown in Figure 18.18a.

Sections 37.4-37.8

37.6\* (Use [tabbed panes](#)) Modify Listing 37.7, DisplayFigure.java, to add a panel of radio buttons for specifying the tab placement of the tabbed pane, as shown in Figure 37.24.

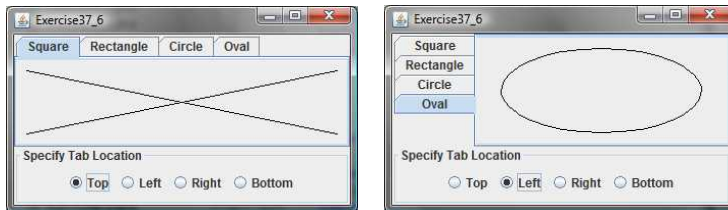


Figure 37.24

The radio buttons let you choose the tab placement of the tabbed pane.

37.7\* (Use [tabbed pane](#)) Rewrite Exercise 37.4 using tabbed panes instead of [CardLayout](#) (see Figure 37.25).

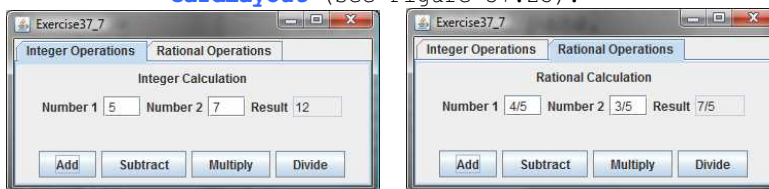
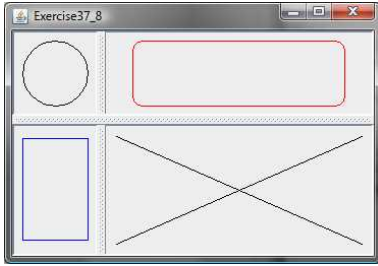


Figure 37.25

A tabbed pane is used to select panels that perform integer operations and rational number operations.

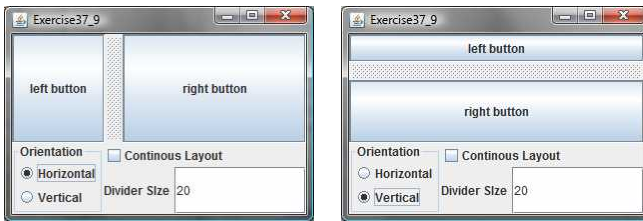
37.8\* (Use [JSplitPane](#)) Create a program that displays four figures in split panes, as shown in Figure 37.26. Use the [FigurePanel](#) class defined in Listing 15.3, FigurePanel.java.



**Figure 37.26**

*Four figures are displayed in split panes.*

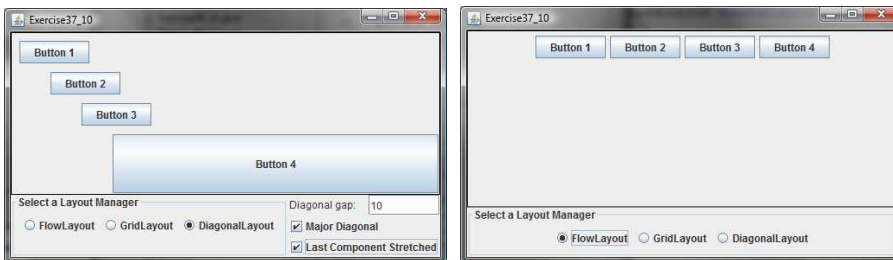
37.9\* (Demonstrate [JSplitPane](#) properties) Create a program that enables the user to set the properties of a split pane dynamically, as shown in Figure 37.27.



**Figure 37.27**

*The program enables you to set the properties of a split pane dynamically.*

37.10\* (Demonstrate [DiagonalLayout](#) properties) Rewrite Listing 37.5 ShowDiagonalLayout.java to add a panel that show the properties of a [DiagonalLayout](#). The panel disappears when the DiagonalLayout radio button is unchecked, and reappears when the DiagonalLayout radio button is checked, as shown in Figure 37.28.



**Figure 37.28**

*The program enables you to set the properties of the DiagonalLayout dynamically.*



*\*\*\*This is a bonus Web chapter*

## **CHAPTER 38**

### **Menus, Toolbars, and Dialogs**

#### **Objectives**

- To create menus using components JMenuBar, JMenu, JMenuItem, JCheckBoxMenuItem, and JRadioButtonMenuItem (§38.2).
- To create popup menus using components JPopupMenu, JMenuItem, JCheckBoxMenuItem, and JRadioButtonMenuItem (§38.3).
- To use JToolBar to create toolbars (§38.4).
- To use Action objects to generalize the code for processing actions (§38.5).
- To create standard dialogs using the JOptionPane class (§38.6).
- To extend the JDialog class to create custom dialogs (§38.7).
- To select colors using JColorChooser (§38.8).
- To use JFileChooser to display Open and Save File dialogs (§38.9).

## 38.1 Introduction

Java provides a comprehensive solution for building graphical user interfaces. This chapter introduces menus, popup menus, toolbars, and dialogs. You will also learn how to use Action objects to generalize the code for processing actions.

## 38.2 Menus

### <margin note: menu>

Menus make selection easier and are widely used in window applications. Java provides five classes that implement menus: JMenuBar, JMenu, JMenuItem, JCheckBoxMenuItem, and JRadioButtonMenuItem.

### <margin note: menu item>

JMenuBar is a top-level menu component used to hold the menus. A menu consists of *menu items* that the user can select (or toggle on or off). A menu item can be an instance of JMenuItem, JCheckBoxMenuItem, or JRadioButtonMenuItem. Menu items can be associated with icons, keyboard mnemonics, and keyboard accelerators. Menu items can be separated using separators.

### 38.2.1 Creating Menus

The sequence of implementing menus in Java is as follows:

1. Create a menu bar and associate it with a frame or an applet by using the setJMenuBar method. For example, the following code creates a frame and a menu bar, and sets the menu bar in the frame:

```
JFrame frame = new JFrame();
frame.setSize(300, 200);
frame.setVisible(true);
JMenuBar jmb = new JMenuBar();
frame.setJMenuBar(jmb); // Attach a menu bar to a frame
```

2. Create menus and associate them with the menu bar. You can use the following constructor to create a menu:

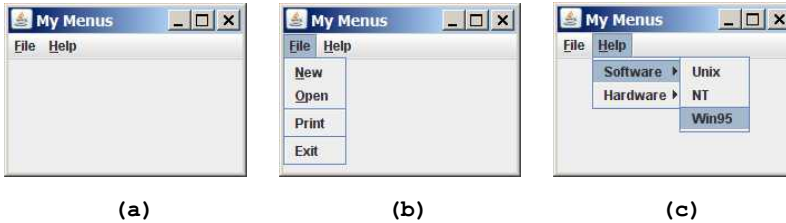
```
public JMenu(String label)
```

Here is an example of creating menus:

```
JMenu fileMenu = new JMenu("File");
JMenu helpMenu = new JMenu("Help");
```

This creates two menus labeled File and Help, as shown in Figure 38.1(a). The menus will not be seen until they are added to an instance of JMenuBar, as follows:

```
jmb.add(fileMenu);
jmb.add(helpMenu);
```



**Figure 38.1**

(a) The menu bar appears below the title bar on the frame. (b) Clicking a menu on the menu bar reveals the items under the menu. (c) Clicking a menu item reveals the submenu items under the menu item.

3. Create menu items and add them to the menus.

```
fileMenu.add(new JMenuItem("New"));
fileMenu.add(new JMenuItem("Open"));
fileMenu.addSeparator();
fileMenu.add(new JMenuItem("Print"));
fileMenu.addSeparator();
fileMenu.add(new JMenuItem("Exit"));
```

This code adds the menu items `New`, `Open`, a separator bar, `Print`, another separator bar, and `Exit`, in this order, to the `File` menu, as shown in Figure 38.1(b). The `addSeparator()` method adds a separator bar in the menu.

3.1. Creating submenu items.

You can also embed menus inside menus so that the embedded menus become submenus. Here is an example:

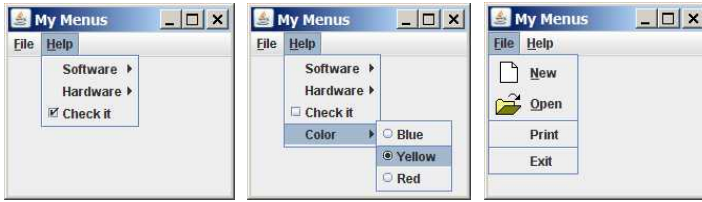
```
JMenu softwareHelpSubMenu = new JMenu("Software");
JMenu hardwareHelpSubMenu = new JMenu("Hardware");
helpMenu.add(softwareHelpSubMenu);
helpMenu.add(hardwareHelpSubMenu);
softwareHelpSubMenu.add(new JMenuItem("Unix"));
softwareHelpSubMenu.add(new JMenuItem("NT"));
softwareHelpSubMenu.add(new JMenuItem("Win95"));
```

This code adds two submenus, `softwareHelpSubMenu` and `hardwareHelpSubMenu`, in `helpMenu`. The menu items `Unix`, `NT`, and `Win95` are added to `softwareHelpSubMenu` (see Figure 38.1(c)).

3.2. Creating check-box menu items.

You can also add a `JCheckBoxMenuItem` to a `JMenu`. `JCheckBoxMenuItem` is a subclass of `JMenuItem` that adds a Boolean state to the `JMenuItem`, and displays a check when its state is true. You can click a menu item to turn it on or off. For example, the following statement adds the check-box menu item `Check it` (see Figure 38.2(a)).

```
helpMenu.add(new JCheckBoxMenuItem("Check it"));
```



(a)  
**Figure 38.2**

(b) You can use `JRadioButtonMenuItem` to choose among mutually exclusive menu choices. (c) You can set image icons, keyboard mnemonics, and keyboard accelerators in menus.

### 3.3. Creating radio-button menu items.

You can also add radio buttons to a menu, using the `JRadioButtonMenuItem` class. This is often useful when you have a group of mutually exclusive choices in the menu. For example, the following statements add a submenu named Color and a set of radio buttons for choosing a color (see Figure 38.2(b)):

```
JMenu colorHelpSubMenu = new JMenu("Color");
helpMenu.add(colorHelpSubMenu);

JRadioButtonMenuItem jrbmiBlue, jrbmiYellow, jrbmiRed;
colorHelpSubMenu.add(jrbmiBlue =
 new JRadioButtonMenuItem("Blue"));
colorHelpSubMenu.add(jrbmiYellow =
 new JRadioButtonMenuItem("Yellow"));
colorHelpSubMenu.add(jrbmiRed =
 new JRadioButtonMenuItem("Red"));

ButtonGroup btg = new ButtonGroup();
btg.add(jrbmiBlue);
btg.add(jrbmiYellow);
btg.add(jrbmiRed);
```

4. The menu items generate `ActionEvent`. Your listener class must implement the `ActionListener` and the `actionPerformed` handler to respond to the menu selection.

#### 38.2.2 Image Icons, Keyboard Mnemonics, and Keyboard Accelerators

The menu components `JMenu`, `JMenuItem`, `JCheckBoxMenuItem`, and `JRadioButtonMenuItem` have the `icon` and `mnemonic` properties. For example, using the following code, you can set icons for the New and Open menu items, and set keyboard mnemonics for File, Help, New, and Open:

```
JMenuItem jmiNew, jmiOpen;
fileMenu.add(jmiNew = new JMenuItem("New"));
fileMenu.add(jmiOpen = new JMenuItem("Open"));
jmiNew.setIcon(new ImageIcon("image/new.gif"));
jmiOpen.setIcon(new ImageIcon("image/open.gif"));
helpMenu.setMnemonic('H');
fileMenu.setMnemonic('F');
jmiNew.setMnemonic('N');
jmiOpen.setMnemonic('O');
```

The new icons and mnemonics are shown in Figure 38.2(c). You can also use `JMenuItem` constructors like the ones that follow to construct and set an icon or mnemonic in one statement.

```
public JMenuItem(String label, Icon icon);
public JMenuItem(String label, int mnemonic);
```

By default, the text is at the right of the icon. Use `setHorizontalTextPosition(SwingConstants.LEFT)` to set the text to the left of the icon.

### <margin note: accelerator>

To select a menu, press the ALT key and the mnemonic key. For example, press ALT+F to select the File menu, and then press ALT+O to select the Open menu item. Keyboard mnemonics are useful, but they only let you select menu items from the currently open menu. Key accelerators, however, let you select a menu item directly by pressing the CTRL and accelerator keys. For example, by using the following code, you can attach the accelerator key CTRL+O to the Open menu item:

```
jmiOpen.setAccelerator(KeyStroke.getKeyStroke
(KeyEvent.VK_O, ActionEvent.CTRL_MASK));
```

The `setAccelerator` method takes a `KeyStroke` object. The static method `getKeyStroke` in the `KeyStroke` class creates an instance of the keystroke. `VK_O` is a constant representing the `O` key, and `CTRL_MASK` is a constant indicating that the `CTRL` key is associated with the keystroke.

NOTE: As shown in Figure 17.1, `AbstractButton` is the superclass for `JButton` and `JMenuItem`, and `JMenuItem` is a superclass for `JCheckBoxMenuItem`, `JMenu`, and `JRadioButtonMenuItem`. The menu components are very similar to buttons.

### 38.2.3 Example: Using Menus

This section gives an example that creates a user interface to perform arithmetic. The interface contains labels and text fields for Number 1, Number 2, and Result. The Result text field displays the result of the arithmetic operation between Number 1 and Number 2. Figure 38.3 contains a sample run of the program.



Figure 38.3

Arithmetic operations can be performed by clicking buttons or by choosing menu items from the Operation menu.

Here are the major steps in the program (Listing 38.1):

1. Create a menu bar and set it in the applet. Create the menus Operation and Exit, and add them to the menu bar. Add the menu items Add, Subtract, Multiply, and Divide under the Operation menu, and add the menu item Close under the Exit menu.
2. Create a panel to hold labels and text fields, and place the panel in the center of the applet.
3. Create a panel to hold the four buttons labeled Add, Subtract, Multiply, and Divide. Place the panel in the south of the applet.
4. Implement the `actionPerformed` handler to process the events from the menu items and the buttons.

Listing 38.1 MenuDemo.java

```

<margin note line 17: menu bar>
<margin note line 20: set menu bar>
<margin note line 28: exit menus>
<margin note line 33: add menu items>
<margin note line 40: accelerator>
<margin note line 61: buttons>
<margin note line 72: register listener>
<margin note line 78: register listener>
<margin note line 84: register listener>
<margin note line 90: register listener>
<margin note line 96: register listener>
<margin note line 102: register listener>
<margin note line 108: register listener>
<margin note line 114: register listener>
<margin note line 120: register listener>
<margin note line 129: calculator>
<margin note line 149: main method omitted>

1 import java.awt.*;
2 import java.awt.event.*;
3 import javax.swing.*;
4
5 public class MenuDemo extends JApplet {
6 // Text fields for Number 1, Number 2, and Result
7 private JTextField jtfNum1, jtfNum2, jtfResult;
8
9 // Buttons "Add", "Subtract", "Multiply" and "Divide"
10 private JButton jbtAdd, jbtSub, jbtMul, jbtDiv;
11
12 // Menu items "Add", "Subtract", "Multiply", "Divide" and "Close"
13 private JMenuItem jmiAdd, jmiSub, jmiMul, jmiDiv, jmiClose;
14
15 public MenuDemo() {
16 // Create menu bar
17 JMenuBar jmb = new JMenuBar();
18
19 // Set menu bar to the applet
20 setJMenuBar(jmb);
21
22 // Add menu "Operation" to menu bar
23 JMenu operationMenu = new JMenu("Operation");
24 operationMenu.setMnemonic('O');
25 jmb.add(operationMenu);
26
27 // Add menu "Exit" to menu bar
28 JMenu exitMenu = new JMenu("Exit");
29 exitMenu.setMnemonic('E');
30 jmb.add(exitMenu);
31

```

```

32 // Add menu items with mnemonics to menu "Operation"
33 operationMenu.add(jmiAdd= new JMenuItem("Add", 'A'));
34 operationMenu.add(jmiSub = new JMenuItem("Subtract", 'S'));
35 operationMenu.add(jmiMul = new JMenuItem("Multiply", 'M'));
36 operationMenu.add(jmiDiv = new JMenuItem("Divide", 'D'));
37 exitMenu.add(jmiClose = new JMenuItem("Close", 'C'));
38
39 // Set keyboard accelerators
40 jmiAdd.setAccelerator(
41 KeyStroke.getKeyStroke(KeyEvent.VK_A, ActionEvent.CTRL_MASK));
42 jmiSub.setAccelerator(
43 KeyStroke.getKeyStroke(KeyEvent.VK_S, ActionEvent.CTRL_MASK));
44 jmiMul.setAccelerator(
45 KeyStroke.getKeyStroke(KeyEvent.VK_M, ActionEvent.CTRL_MASK));
46 jmiDiv.setAccelerator(
47 KeyStroke.getKeyStroke(KeyEvent.VK_D, ActionEvent.CTRL_MASK));
48
49 // Panel p1 to hold text fields and labels
50 JPanel p1 = new JPanel(new FlowLayout());
51 p1.add(new JLabel("Number 1"));
52 p1.add(jtfNum1 = new JTextField(3));
53 p1.add(new JLabel("Number 2"));
54 p1.add(jtfNum2 = new JTextField(3));
55 p1.add(new JLabel("Result"));
56 p1.add(jtfResult = new JTextField(4));
57 jtfResult.setEditable(false);
58
59 // Panel p2 to hold buttons
60 JPanel p2 = new JPanel(new FlowLayout());
61 p2.add(jbtAdd = new JButton("Add"));
62 p2.add(jbtSub = new JButton("Subtract"));
63 p2.add(jbtMul = new JButton("Multiply"));
64 p2.add(jbtDiv = new JButton("Divide"));
65
66 // Add panels to the frame
67 setLayout(new BorderLayout());
68 add(p1, BorderLayout.CENTER);
69 add(p2, BorderLayout.SOUTH);
70
71 // Register listeners
72 jbtAdd.addActionListener(new ActionListener() {
73 @Override
74 public void actionPerformed(ActionEvent e) {
75 calculate('+');
76 }
77 });
78 jbtSub.addActionListener(new ActionListener() {
79 @Override
80 public void actionPerformed(ActionEvent e) {
81 calculate('-');
82 }
83 });
84 jbtMul.addActionListener(new ActionListener() {
85 @Override
86 public void actionPerformed(ActionEvent e) {
87 calculate('*');
88 }
89 });
90 jbtDiv.addActionListener(new ActionListener() {
91 @Override
92 public void actionPerformed(ActionEvent e) {
93 calculate('/');
94 }
95 });
96 jmiAdd.addActionListener(new ActionListener() {
97 @Override

```

```

98 public void actionPerformed(ActionEvent e) {
99 calculate('+');
100 }
101 });
102 jmiSub.addActionListener(new ActionListener() {
103 @Override
104 public void actionPerformed(ActionEvent e) {
105 calculate('-');
106 }
107 });
108 jmiMul.addActionListener(new ActionListener() {
109 @Override
110 public void actionPerformed(ActionEvent e) {
111 calculate('*');
112 }
113 });
114 jmiDiv.addActionListener(new ActionListener() {
115 @Override
116 public void actionPerformed(ActionEvent e) {
117 calculate('/');
118 }
119 });
120 jmiClose.addActionListener(new ActionListener() {
121 @Override
122 public void actionPerformed(ActionEvent e) {
123 System.exit(1);
124 }
125 });
126 }
127
128 /** Calculate and show the result in jtfResult */
129 private void calculate(char operator) {
130 // Obtain Number 1 and Number 2
131 int num1 = (Integer.parseInt(jtfNum1.getText().trim()));
132 int num2 = (Integer.parseInt(jtfNum2.getText().trim()));
133 int result = 0;
134
135 // Perform selected operation
136 switch (operator) {
137 case '+': result = num1 + num2;
138 break;
139 case '-': result = num1 - num2;
140 break;
141 case '*': result = num1 * num2;
142 break;
143 case '/': result = num1 / num2;
144 }
145
146 // Set result in jtfResult
147 jtfResult.setText(String.valueOf(result));
148 }
149 }

```

The program creates a menu bar, `jmb`, which holds two menus: `operationMenu` and `exitMenu` (lines 17-30). The `operationMenu` contains four menu items for doing arithmetic: Add, Subtract, Multiply, and Divide. The `exitMenu` contains the menu item Close for exiting the program. The menu items in the Operation menu are created with keyboard mnemonics and accelerators.

The user enters two numbers in the number fields. When an operation is chosen from the menu, its result, involving two numbers, is displayed in the Result field. The user can also click the buttons to perform the same operation.



The private method `calculate(char operator)` (lines 129-148) retrieves operands from the text fields in Number 1 and Number 2, applies the binary operator on the operands, and sets the result in the Result text field.

NOTE:

#### *<margin note: placing menus>*

The menu bar is usually attached to the window using the `setJMenuBar` method. However, like any other component, it can be placed in a container. For instance, you can place a menu bar in the south of the container with `BorderLayout`.

### 38.3 Popup Menus

#### *<margin note: popup menu>*

A *popup menu*, also known as a *context menu*, is like a regular menu, but does not have a menu bar and can float anywhere on the screen. Creating a popup menu is similar to creating a regular menu. First, you create an instance of `JPopupMenu`, then you can add `JMenuItem`, `JCheckBoxMenuItem`, `JRadioButtonMenuItem`, and separators to the popup menu. For example, the following code creates a `JPopupMenu` and adds `JMenuItems` into it:

```
JPopupMenu jPopupMenu = new JPopupMenu();
jPopupMenu.add(new JMenuItem("New"));
jPopupMenu.add(new JMenuItem("Open"));
```

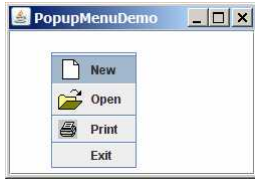
A regular menu is always attached to a menu bar using the `setJMenuBar` method, but a popup menu is associated with a parent component and is displayed using the `show` method in the `JPopupMenu` class. You specify the parent component and the location of the popup menu, using the coordinate system of the parent like this:

```
jPopupMenu.show(component, x, y);
```

#### *<margin note: popup trigger>*

Customarily, you display a popup menu by pointing to a GUI component and clicking a certain mouse button, the so-called *popup trigger*. Popup triggers are system dependent. In Windows, the popup menu is displayed when the right mouse button is released. In Motif, the popup menu is displayed when the third mouse button is pressed and held down.

Listing 38.2 gives an example that creates a text area in a scroll pane. When the mouse points to the text area, clicking a mouse button displays a popup menu, as shown in Figure 38.4.



**Figure 38.4**

*A popup menu is displayed when the popup trigger is issued on the text area.*

Here are the major steps in the program (Listing 38.2):

1. Create a popup menu using `JPopupMenu`. Create menu items for New, Open, Print, and Exit using `JMenuItem`. For the menu items with both labels and icons, it is convenient to use the `JMenuItem(label, icon)` constructor.
2. Add the menu items into the popup menu.
3. Create a scroll pane and add a text area into it. Place the scroll pane in the center of the applet.
4. Implement the `actionPerformed` handler to process the events from the menu items.
5. Implement the `mousePressed` and `mouseReleased` methods to process the events for handling popup triggers.

**Listing 38.2** PopupMenuDemo.java

*<margin note line 6: popup menu>*  
*<margin note line 17: add menu items>*  
*<margin note line 27: register listener>*  
*<margin note line 33: register listener>*  
*<margin note line 39: register listener>*  
*<margin note line 45: register listener>*  
*<margin note line 54: show popup menu>*  
*<margin note line 59: show popup menu>*  
*<margin note line 69: main method omitted>*

```

1 import javax.swing.*;
2 import java.awt.*;
3 import java.awt.event.*;
4
5 public class PopupMenuDemo extends JApplet {
6 private JPopupMenu jPopupMenu1 = new JPopupMenu();
7 private JMenuItem jmiNew = new JMenuItem("New",
8 new ImageIcon(getClass().getResource("image/new.gif")));
9 private JMenuItem jmiOpen = new JMenuItem("Open",
10 new ImageIcon(getClass().getResource("image/open.gif")));
11 private JMenuItem jmiPrint = new JMenuItem("Print",
12 new ImageIcon(getClass().getResource("image/print.gif")));
13 private JMenuItem jmiExit = new JMenuItem("Exit");
14 private JTextArea jTextAreal = new JTextArea();
15
16 public PopupMenuDemo() {
17 jPopupMenu1.add(jmiNew);
18 jPopupMenu1.add(jmiOpen);
19 jPopupMenu1.addSeparator();
20 jPopupMenu1.add(jmiPrint);
21 jPopupMenu1.addSeparator();
22 jPopupMenu1.add(jmiExit);
23 jPopupMenu1.add(jmiExit);
24

```

```

25 add(new JScrollPane(jTextArea1), BorderLayout.CENTER);
26
27 jmiNew.addActionListener(new ActionListener() {
28 @Override
29 public void actionPerformed(ActionEvent e) {
30 System.out.println("Process New");
31 }
32 });
33 jmiOpen.addActionListener(new ActionListener() {
34 @Override
35 public void actionPerformed(ActionEvent e) {
36 System.out.println("Process Open");
37 }
38 });
39 jmiPrint.addActionListener(new ActionListener() {
40 @Override
41 public void actionPerformed(ActionEvent e) {
42 System.out.println("Process Print");
43 }
44 });
45 jmiExit.addActionListener(new ActionListener() {
46 @Override
47 public void actionPerformed(ActionEvent e) {
48 System.exit(1);
49 }
50 });
51 jTextArea1.addMouseListener(new MouseAdapter() {
52 @Override
53 public void mousePressed(MouseEvent e) { // For Motif
54 showPopup(e);
55 }
56
57 @Override
58 public void mouseReleased(MouseEvent e) { // For Windows
59 showPopup(e);
60 }
61 });
62 }
63
64 /** Display popup menu when triggered */
65 private void showPopup(java.awt.event.MouseEvent evt) {
66 if (evt.isPopupTrigger())
67 jPopupMenu1.show(evt.getComponent(), evt.getX(), evt.getY());
68 }
69 }

```

The process of creating popup menus is similar to the process for creating regular menus. To create a popup menu, create a `JPopupMenu` as the basis (line 6) and add `JMenuItems` to it (lines 17-23).

To show a popup menu, use the `show` method by specifying the parent component and the location for the popup menu (line 61). The `show` method is invoked when the popup menu is triggered by a particular mouse click on the text area. Popup triggers are system dependent. The listener implements the `mouseReleased` handler for displaying the popup menu in Windows (lines 52-54) and the `mousePressed` handler for displaying the popup menu in Motif (lines 48-50).

TIP

*<margin note: simplify popup menu>*

Java provides a new `setComponentPopupMenu(JPopupMenu)` method in the `JComponent` class, which can be used to add a popup menu on a component. This method automatically handles mouse listener registration and popup display. Using this method, you may delete the `showPopup` method in lines 59-62 and replace the code in lines 47-55 with the following statement:

```
jTextArea1.setComponentPopupMenu(jPopupMenu1);
```

*\*\*\*End of TIP*

### 38.4 `JToolBar`

*<margin note: toolbar>*

In user interfaces, a *toolbar* is often used to hold commands that also appear in the menus. Frequently used commands are placed in a toolbar for quick access. Clicking a command in the toolbar is faster than choosing it from the menu.

Swing provides the `JToolBar` class as the container to hold toolbar components. `JToolBar` uses `BoxLayout` to manage components by default. You can set a different layout manager if desired. The components usually appear as icons. Since icons are not components, they cannot be placed into a toolbar directly. Instead you place buttons into the toolbar and set the icons on the buttons. An instance of `JToolBar` is like a regular container. Often it is placed in the north, west, or east of a container of `BorderLayout`.

The following properties in the `JToolBar` class are often useful:

- **orientation** specifies whether the items in the toolbar appear horizontally or vertically. The possible values are `JToolBar.HORIZONTAL` and `JToolBar.VERTICAL`. The default value is `JToolBar.HORIZONTAL`.
- **floatable** is a `boolean` value that specifies whether the toolbar can be floated. By default, a toolbar is floatable.

Listing 38.3 gives an example that creates a `JToolBar` to hold three buttons with the icons representing the commands New, Open, and Print, as shown in Figure 38.5.



**Figure 38.5**

The toolbar contains the icons representing the commands New, Open, and Print.

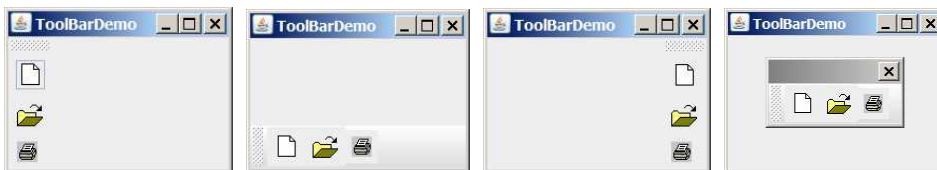
**Listing 38.3** ToolBarDemo.java

```
<margin note line 6: buttons>
<margin note line 13: toolbar>
<margin note line 27: add toolbar>
<margin note line 29: main method omitted>

1 import javax.swing.*;
2 import java.awt.*;
3
4 public class ToolBarDemo extends JApplet {
5 private JButton jbtNew = new JButton(
6 new ImageIcon(getClass().getResource("/image/new.gif")));
7 private JButton jbtOpen = new JButton(
8 new ImageIcon(getClass().getResource("/image/open.gif")));
9 private JButton jbPrint = new JButton(
10 new ImageIcon(getClass().getResource("/image/print.gif")));
11
12 public ToolBarDemo() {
13 JToolBar jToolBar1 = new JToolBar("My Tool Bar");
14 jToolBar1.setFloatable(true);
15 jToolBar1.add(jbtNew);
16 jToolBar1.add(jbtOpen);
17 jToolBar1.add(jbPrint);
18
19 jbtNew.setToolTipText("New");
20 jbtOpen.setToolTipText("Open");
21 jbPrint.setToolTipText("Print");
22
23 jbtNew.setBorderPainted(false);
24 jbtOpen.setBorderPainted(false);
25 jbPrint.setBorderPainted(false);
26
27 add(jToolBar1, BorderLayout.NORTH);
28 }
29 }
```

A `JToolBar` is created in line 13. The toolbar is a container with `BoxLayout` by default. Using the `orientation` property, you can specify whether components in the toolbar are organized horizontally or vertically. By default, it is horizontal.

By default, the toolbar is floatable, and a floatable controller is displayed in front of its components. You can drag the floatable controller to move the toolbar to different locations of the window or can show the toolbar in a separate window, as shown in Figure 38.6.



**Figure 38.6**

The toolbar buttons are floatable.

You can also set a title for the floatable toolbar, as shown in Figure 38.7(a). To do so, create a toolbar using the `JToolBar(String title)` constructor. If you set `floatable` false, the floatable controller is not displayed, as shown in Figure 38.7(b). If you set a border (e.g., a line border), as shown in Figure 38.7(c), the line border is displayed and the floatable controller is not displayed.

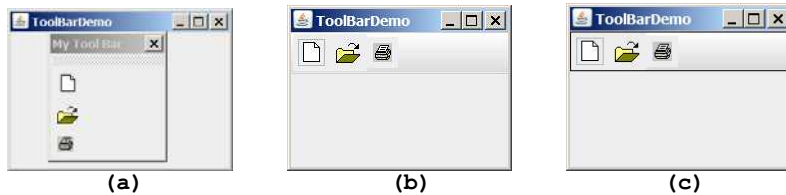


Figure 38.7

The toolbar buttons can be customized in many forms.

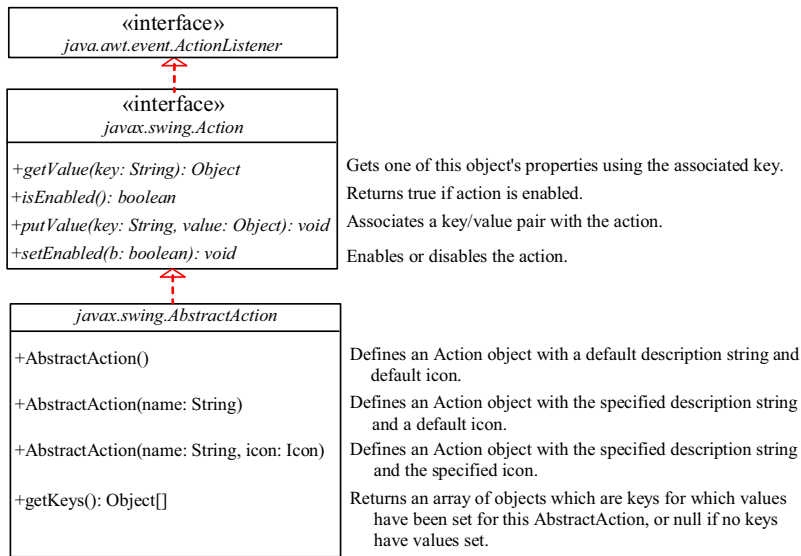
TIP: For the floatable feature to work properly, do the following: (1) place a toolbar to one side of the container of `BorderLayout` and add no components to the other sides; (2) don't set border on a toolbar. Setting a border would make it non-floatable.

### 38.5 Processing Actions Using the Action Interface

Often menus and toolbars contain some common actions. For example, you can save a file by choosing *File, Save*, or by clicking the save button in the toolbar. Swing provides the Action interface, which can be used to create action objects for processing actions. Using Action objects, common action processing can be centralized and separated from the other application code.

The Action interface is a subinterface of ActionListener, as shown in Figure 38.8. Additionally, it defines several methods for checking whether the action is enabled, for enabling and disabling the action, and for retrieving and setting the associated action value using a key. The key can be any string, but four keys have predefined meanings:

Key	Description
Action.NAME	A name for the action
Action.SMALL_ICON	A small icon for the action
Action.SHORT_DESCRIPTION	A tool tip for the action
Action.LONG_DESCRIPTION	A description for online help



**Figure 38.8**

The Action interface provides a useful extension to the ActionListener interface in cases where the same functionality may be accessed by several controls. The AbstractAction class provides a default implementation for Action.

AbstractAction is a default implementation of the Action interface, as shown in Figure 38.8. It implements all the methods in the Action interface except the actionPerformed method. Additionally, it defines the getKeys() method.

Since AbstractAction is an abstract class, you cannot create an instance using its constructor. However, you can create a concrete subclass of AbstractAction and implement the actionPerformed method. This subclass can be conveniently defined as an anonymous inner class. For example, the following code creates an Action object for terminating a program.

```

Action exitAction = new AbstractAction("Exit") {
 public void actionPerformed(ActionEvent e) {
 System.exit(1);
 }
};

```

Certain containers, such as JMenu and JToolBar, know how to add an Action object. When an Action object is added to such a container, the container automatically creates an appropriate component for the Action object and registers a listener with the Action object. Here is an example of adding an Action object to a menu and a toolbar:

```

jMenu.add(exitAction);
jToolBar.add(exitAction);

```

Several Swing components, such as JButton, JRadioButton, and JCheckBox, contain constructors to create instances from Action objects. For example, you can create a JButton from an Action object, as follows:

```
JButton jbt = new JButton(exitAction);
```

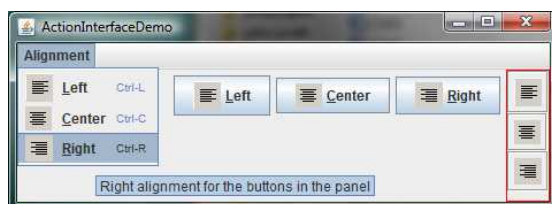
Action objects can also be associated with mnemonic and accelerator keys. To associate actions with a mnemonic key (e.g., ALT+E), use the following statement:

```
exitAction.putValue(Action.MNEMONIC_KEY, new Integer(KeyEvent.VK_E));
```

To associate actions with an accelerator key (e.g., CTRL+E), use the following statement:

```
KeyStroke exitKey =
 KeyStroke.getKeyStroke(KeyEvent.VK_E, KeyEvent.CTRL_MASK);
exitAction.putValue(Action.ACCELERATOR_KEY, exitKey);
```

Listing 38.4 gives an example that creates three menu items, Left, Center, and Right, three toolbar buttons, Left, Center, and Right, and three regular buttons, Left, Center, and Right, in a panel, as shown in Figure 38.9. The panel that holds the buttons uses the FlowLayout. The actions of the left, center, and right buttons set the alignment of the FlowLayout to left, right, and center, respectively. The actions of the menu items, the toolbar buttons, and the buttons in the panel can be processed through common action handlers using the Action interface.



**Figure 38.9**

*Left, Center, and Right appear in the menu, in the toolbar, and in regular buttons.*

**Listing 38.4** ActionInterfaceDemo.java

```
<margin note line 11: image icon>
<margin note line 19: create action>
<margin note line 33: menu>
<margin note line 44: toolbar>
<margin note line 52: button>
<margin note line 64: custom action>
<margin note line 67: constructor>
<margin note line 72: constructor>
<margin note line 82: handler>
<margin note line 93: main method omitted>
```

```
1 import java.awt.*;
2 import java.awt.event.*;
3 import javax.swing.*;
4
5 public class ActionInterfaceDemo extends JApplet {
6 private JPanel buttonPanel = new JPanel();
7 private FlowLayout flowLayout = new FlowLayout();
8
9 public ActionInterfaceDemo() {
10 // Create image icons
11 ImageIcon leftImageIcon = new ImageIcon(getClass().getResource(
```



```

12 "/image/leftAlignment.png"));
13 ImageIcon centerImageIcon = new ImageIcon(getClass().getResource(
14 "/image/centerAlignment.png"));
15 ImageIcon rightImageIcon = new ImageIcon(getClass().getResource(
16 "/image/rightAlignment.png"));
17
18 // Create actions
19 Action leftAction = new MyAction("Left", leftImageIcon,
20 "Left alignment for the buttons in the panel",
21 new Integer(KeyEvent.VK_L),
22 KeyStroke.getKeyStroke(KeyEvent.VK_L, ActionEvent.CTRL_MASK));
23 Action centerAction = new MyAction("Center", centerImageIcon,
24 "Center alignment for the buttons in the panel",
25 new Integer(KeyEvent.VK_C),
26 KeyStroke.getKeyStroke(KeyEvent.VK_C, ActionEvent.CTRL_MASK));
27 Action rightAction = new MyAction("Right", rightImageIcon,
28 "Right alignment for the buttons in the panel",
29 new Integer(KeyEvent.VK_R),
30 KeyStroke.getKeyStroke(KeyEvent.VK_R, ActionEvent.CTRL_MASK));
31
32 // Create menus
33 JMenuBar jMenuBar1 = new JMenuBar();
34 JMenu jmenuAlignment = new JMenu("Alignment");
35 setJMenuBar(jMenuBar1);
36 jMenuBar1.add(jmenuAlignment);
37
38 // Add actions to the menu
39 jmenuAlignment.add(leftAction);
40 jmenuAlignment.add(centerAction);
41 jmenuAlignment.add(rightAction);
42
43 // Add actions to the toolbar
44 JToolBar jToolBar1 = new JToolBar(JToolBar.VERTICAL);
45 jToolBar1.setBorder(BorderFactory.createLineBorder(Color.red));
46 jToolBar1.add(leftAction);
47 jToolBar1.add(centerAction);
48 jToolBar1.add(rightAction);
49
50 // Add buttons to the button panel
51 buttonPanel.setLayout(flowLayout);
52 JButton jbtLeft = new JButton(leftAction);
53 JButton jbtCenter = new JButton(centerAction);
54 JButton jbtRight = new JButton(rightAction);
55 buttonPanel.add(jbtLeft);
56 buttonPanel.add(jbtCenter);
57 buttonPanel.add(jbtRight);
58
59 // Add tool bar to the east and panel to the center
60 add(jToolBar1, BorderLayout.EAST);
61 add(buttonPanel, BorderLayout.CENTER);
62 }
63
64 private class MyAction extends AbstractAction {
65 String name;
66
67 MyAction(String name, Icon icon) {
68 super(name, icon);
69 this.name = name;
70 }
71
72 MyAction(String name, Icon icon, String desc, Integer mnemonic,
73 KeyStroke accelerator) {
74 super(name, icon);
75 putValue(Action.SHORT_DESCRIPTION, desc);
76 putValue(Action.MNEMONIC_KEY, mnemonic);
77 putValue(Action.ACCELERATOR_KEY, accelerator);

```

```

78 this.name = name;
79 }
80
81 @Override
82 public void actionPerformed(ActionEvent e) {
83 if (name.equals("Left"))
84 flowLayout.setAlignment(FlowLayout.LEFT);
85 else if (name.equals("Center"))
86 flowLayout.setAlignment(FlowLayout.CENTER);
87 else if (name.equals("Right"))
88 flowLayout.setAlignment(FlowLayout.RIGHT);
89
90 buttonPanel.revalidate();
91 }
92 }
93 }

```

The inner class `MyAction` extends `AbstractAction` with a constructor to construct an action with a name and an icon (lines 67-70) and another constructor to construct an action with a name, icon, description, mnemonic, and accelerator (lines 72-79). The constructors invoke the `putValue` method to associate the name, icon, description, mnemonic, and accelerator. It implements the `actionPerformed` method to set a new alignment in the panel of the `FlowLayout` (line 82-91). The `revalidate()` method validates the new alignment (line 90).

Three actions, `leftAction`, `centerAction`, and `rightAction`, were created from the `MyAction` class (lines 19-30). Each action has a name, icon, description, mnemonic, and accelerator. The actions are for the menu items and the buttons in the toolbar and in the panel. The menu and toolbar know how to add these objects automatically (lines 39-41, 46-48). Three regular buttons are created with the properties taken from the actions (lines 51-54).

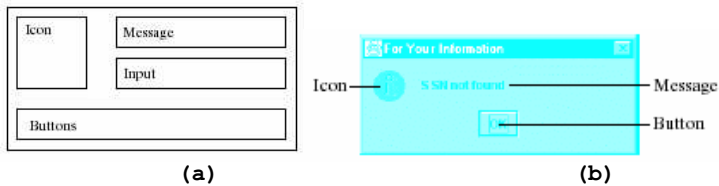
## 38.6 JOptionPane Dialogs

You have used `JOptionPane` to create input and output dialog boxes. This section provides a comprehensive introduction to `JOptionPane` and other dialog boxes. A *dialog box* is normally used as a temporary window to receive additional information from the user or to provide notification that some event has occurred. Java provides the `JOptionPane` class, which can be used to create standard dialogs. You can also build custom dialogs by extending the `JDialog` class.

The `JOptionPane` class can be used to create four kinds of standard dialogs:

- **Message dialog** shows a message and waits for the user to click OK.
- **Confirmation dialog** shows a question and asks for confirmation, such as OK or Cancel.
- **Input dialog** shows a question and gets the user's input from a text field, combo box, or list.
- **Option dialog** shows a question and gets the user's answer from a set of options.

These dialogs are created using the static methods `showXxxDialog` and generally appear as shown in Figure 38.10(a).



**Figure 38.10**

(a) A `JOptionPane` dialog can display an icon, a message, an input, and option buttons. (b) The message dialog displays a message and waits for the user to click OK.

For example, you can use the following method to create a message dialog box, as shown in Figure 38.10(b):

```
JOptionPane.showMessageDialog(null, "SSN not found",
 "For Your Information", JOptionPane.INFORMATION_MESSAGE);
```

### 38.6.1 Message Dialogs

A message dialog box displays a message that alerts the user and waits for the user to click the OK button to close the dialog. The methods for creating message dialogs are:

```
public static void showMessageDialog(Component parentComponent,
 Object message)
public static void showMessageDialog(Component parentComponent,
 Object message,
 String title,
 int messageType)
public static void showMessageDialog(Component parentComponent,
 Object message,
 String title,
 int messageType,
 Icon icon)
```

The `parentComponent` can be any component or `null`. The `message` is an object, but often a string is used. These two parameters must always be specified. The `title` is a string displayed in the title bar of the dialog with the default value "Message".

The `messageType` is one of the following constants:

```
JOptionPane.ERROR_MESSAGE
JOptionPane.INFORMATION_MESSAGE
JOptionPane.PLAIN_MESSAGE
JOptionPane.WARNING_MESSAGE
JOptionPane.QUESTION_MESSAGE
```

By default, `messageType` is `JOptionPane.INFORMATION_MESSAGE`. Each type has an associated icon except the `PLAIN_MESSAGE` type, as shown in Figure 38.11. You can also supply your own icon in the `icon` parameter.

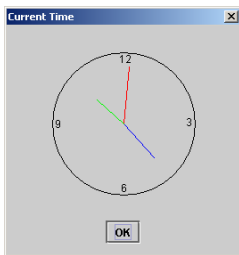


**Figure 38.11**

There are five types of message dialog boxes.

The `message` parameter is an object. If it is a GUI component, the component is displayed. If it is a non-GUI component, the string representation of the object is displayed. For example, the following statement displays a clock in a message dialog, as shown in Figure 38.12. `StillClock` was defined in Listing 15.10.

```
JOptionPane.showMessageDialog(null, new StillClock(),
 "Current Time", JOptionPane.PLAIN_MESSAGE);
```



**Figure 38.12**

A clock is displayed in a message dialog.

### 38.6.2 Confirmation Dialogs

A message dialog box displays a message and waits for the user to click the *OK* button to dismiss the dialog. The message dialog does not return any value. A *confirmation dialog* asks a question and requires the user to respond with an appropriate button. The confirmation dialog returns a value that corresponds to a selected button.

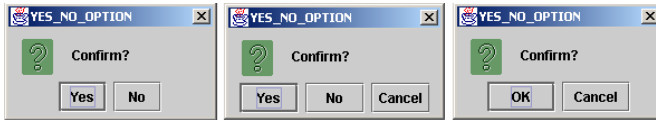
The methods for creating confirmation dialogs are:

```
public static int showConfirmDialog(Component parentComponent,
 Object message)
public static int showConfirmDialog(Component parentComponent,
 Object message,
 String title,
 int optionType)
public static int showConfirmDialog(Component parentComponent,
 Object message,
 String title,
 int optionType,
 int messageType)
public static int showConfirmDialog(Component parentComponent,
 Object message,
 String title,
 int optionType,
 int messageType,
 Icon icon)
```

The parameters `parentComponent`, `message`, `title`, `icon`, and `messageType` are the same as in the `showMessageDialog` method. The default value for `title` is "Select an Option" and for `messageType` is `QUESTION MESSAGE`. The `optionType` determines which buttons are displayed in the dialog. The possible values are:

```
JOptionPane.YES_NO_OPTION
JOptionPane.YES_NO_CANCEL_OPTION
JOptionPane.OK_CANCEL_OPTION
```

Figure 38.13 shows the confirmation dialogs with these options.



**Figure 38.13**

The confirmation dialog displays a question and three types of option buttons, and requires responses from the user.

The `showConfirmDialog` method returns one of the following `int` values corresponding to the selected option:

```
JOptionPane.YES_OPTION
JOptionPane.NO_OPTION
JOptionPane.CANCEL_OPTION
JOptionPane.OK_OPTION
JOptionPane.CLOSED_OPTION
```

These options correspond to the button that was activated, except for the `CLOSED_OPTION`, which implies that the dialog box is closed without buttons activated.

### 38.6.3 Input Dialogs

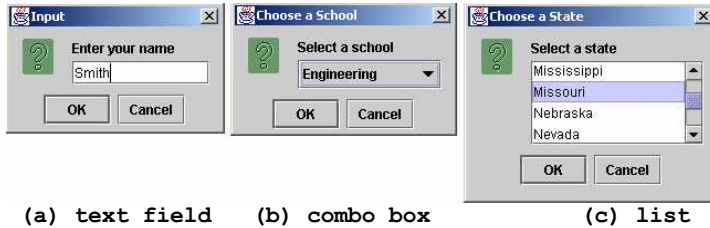
An *input dialog* box is used to receive input from the user. The input can be entered from a text field or selected from a combo box or a list. Selectable values can be specified in an array, and one of them can be designated as the initial selected value. If no selectable value is specified when an input dialog is created, a text field is used for entering input. If fewer than twenty selection values are specified, a combo box is displayed in the input dialog. If twenty or more selection values are specified, a list is used in the input dialog.

The methods for creating input dialogs are shown below:

```
public static String showInputDialog(Object message)
public static String showInputDialog(Component parentComponent,
 Object message)
public static String showInputDialog(Component parentComponent,
 Object message,
 String title,
 int messageType)
public static Object showInputDialog(Component parentComponent,
 Object message,
 int messageType,
 Icon icon,
 Object[] selectionValues,
 Object initialSelectionValue)
```

The first three methods listed above use a text field for input, as shown in Figure 38.14(a). The last method listed above specifies an array of `Object` type as selection values in addition to an object specified as an initial selection. The first three

methods return a String that is entered from the text field in the input dialog. The last method returns an Object selected from a combo box or a list. The input dialog displays a combo box if there are fewer than twenty selection values, as shown in Figure 38.14(b); it displays a list if there are twenty or more selection values, as shown in Figure 38.14(c).



**Figure 38.14**

(a) When creating an input dialog without specifying selection values, the input dialog displays a text field for data entry. (b) When creating an input dialog with selection values, the input dialog displays a combo box if there are fewer than twenty selection values. (c) When creating an input dialog with selection values, the input dialog displays a list if there are twenty or more selection values.

**NOTE**

The showInputDialog method does not have the optionType parameter. The buttons for input dialog are not configurable. The *OK* and *Cancel* buttons are always used.

**38.6.4 Option Dialogs**

An *option dialog* allows you to create custom buttons. You can create an option dialog using the following method:

```
public static int showOptionDialog(Component parentComponent,
 Object message,
 String title,
 int optionType,
 int messageType,
 Icon icon,
 Object[] options,
 Object initialValue)
```

The buttons are specified using the options parameter. The initialValue parameter allows you to specify a button to receive initial focus. The showOptionDialog method returns an int value indicating the button that was activated. For example, here is the code that creates an option dialog, as shown in Figure 38.15:

```
int value =
 JOptionPane.showOptionDialog(null, "Select a button",
 "Option Dialog", JOptionPane.DEFAULT_OPTION,
 JOptionPane.PLAIN_MESSAGE, null,
 new Object[]{"Button 0", "Button 1", "Button 2"}, "Button 1");
```

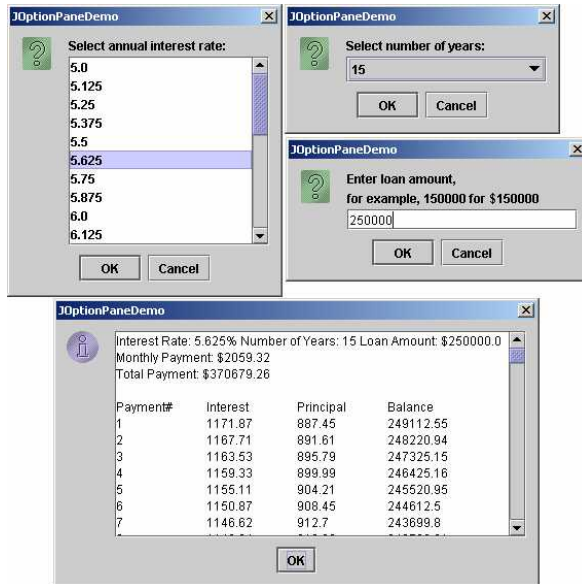


**Figure 38.15**

The option dialog displays the custom buttons.

### 38.6.5 Example: Creating `JOptionPane` Dialogs

This section gives an example that demonstrates the use of `JOptionPane` dialogs. The program prompts the user to select the annual interest rate from a list in an input dialog, the number of years from a combo box in an input dialog, and the loan amount from an input dialog, and it displays the loan payment schedule in a text area inside a `JScrollPane` in a message dialog, as shown in Figure 38.16.



**Figure 38.16**

The input dialogs can contain a list or a combo box for selecting input, and the message dialogs can contain GUI objects like `JScrollPane`.

Here are the major steps in the program (Listing 38.5):

1. Display an input dialog box to let the user select an annual interest rate from a list.
2. Display an input dialog box to let the user select the number of years from a combo box.
3. Display an input dialog box to let the user enter the loan amount.
4. Compute the monthly payment, total payment, and loan payment schedule, and display the result in a text area in a message dialog box.

**Listing 38.5** `JOptionPaneDemo.java`

*<margin note line 12: input dialog>*  
*<margin note line 23: input dialog>*  
*<margin note line 29: input dialog>*  
*<margin note line 70: message dialog>*

```
1 import javax.swing.*;
2
3 public class JOptionPaneDemo {
```

```

4 public static void main(String args[]) {
5 // Create an array for annual interest rates
6 Object[] rateList = new Object[25];
7 int i = 0;
8 for (double rate = 5; rate <= 8; rate += 1.0 / 8)
9 rateList[i++] = new Double(rate);
10
11 // Prompt the user to select an annual interest rate
12 Object annualInterestRateObject = JOptionPane.showInputDialog(
13 null, "Select annual interest rate:", "JOptionPaneDemo",
14 JOptionPane.QUESTION_MESSAGE, null, rateList, null);
15 double annualInterestRate =
16 ((Double)annualInterestRateObject).doubleValue();
17
18 // Create an array for number of years
19 Object[] yearList = {new Integer(7), new Integer(15),
20 new Integer(30)};
21
22 // Prompt the user to enter number of years
23 Object numberOfYearsObject = JOptionPane.showInputDialog(null,
24 "Select number of years:", "JOptionPaneDemo",
25 JOptionPane.QUESTION_MESSAGE, null, yearList, null);
26 int numberOfYears = ((Integer)numberOfYearsObject).intValue();
27
28 // Prompt the user to enter loan amount
29 String loanAmountString = JOptionPane.showInputDialog(null,
30 "Enter loan amount.\nfor example, 150000 for $150000",
31 "JOptionPaneDemo", JOptionPane.QUESTION_MESSAGE);
32 double loanAmount = Double.parseDouble(loanAmountString);
33
34 // Obtain monthly payment and total payment
35 Loan loan = new Loan(
36 annualInterestRate, numberOfYears, loanAmount);
37 double monthlyPayment = loan.getMonthlyPayment();
38 double totalPayment = loan.getTotalPayment();
39
40 // Prepare output string
41 String output = "Interest Rate: " + annualInterestRate + "% " +
42 " Number of Years: " + numberOfYears + " Loan Amount: $"
43 + loanAmount;
44 output += "\nMonthly Payment: " + "$" +
45 (int)(monthlyPayment * 100) / 100.0;
46 output += "\nTotal Payment: $" +
47 (int)(monthlyPayment * 12 * numberOfYears * 100) / 100.0 + "\n";
48
49 // Obtain monthly interest rate
50 double monthlyInterestRate = annualInterestRate / 1200;
51
52 double balance = loanAmount;
53 double interest;
54 double principal;
55
56 // Display the header
57 output += "\nPayment#\tInterest\tPrincipal\tBalance\n";
58
59 for (i = 1; i <= numberOfYears * 12; i++) {
60 interest = (int)(monthlyInterestRate * balance * 100) / 100.0;
61 principal = (int)((monthlyPayment - interest) * 100) / 100.0;
62 balance = (int)((balance - principal) * 100) / 100.0;
63 output += i + "\t" + interest + "\t" + principal + "\t" +
64 balance + "\n";
65 }
66
67 // Display monthly payment and total payment
68 JScrollPane jsp = new JScrollPane(new JTextArea(output));
69 jsp.setPreferredSize(new java.awt.Dimension(400, 200));

```



```

70 JOptionPane.showMessageDialog(null, jsp,
71 "JOptionPaneDemo", JOptionPane.INFORMATION_MESSAGE, null);
72 }
73 }

```

The `JOptionPane` dialog boxes are *modal*, which means that no other window can be accessed until a dialog box is dismissed.

You have used the input dialog box to enter input from a text field. This example shows that input dialog boxes can also contain a list (lines 12-14) or a combo box (lines 23-25) to list input options. The elements of the list are objects. The return value from these input dialog boxes is of the `Object` type. To obtain a `double` value or an `int` value, you have to cast the return object into `Double` or `Integer`, then use the `doubleValue` or `intValue` method to get the `double` or `int` value (lines 15-16 and 26).

You have already used the message dialog box to display a string. This example shows that the message dialog box can also contain GUI objects. The output string is contained in a text area, the text area is inside a scroll pane, and the scroll pane is placed in the message dialog box (lines 68-71).

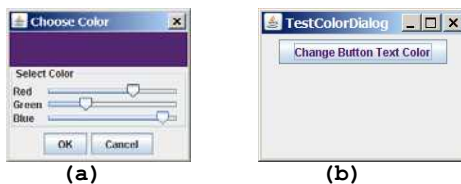
### 38.7 Creating Custom Dialogs

Standard `JOptionPane` dialogs are sufficient in most cases. Occasionally, you need to create custom dialogs. In Swing, the `JDialog` class can be extended to create custom dialogs.

As with `JFrame`, components are added to the `contentPane` of `JDialog`. Creating a custom dialog usually involves laying out user interface components in the dialog, adding buttons for dismissing the dialog, and installing listeners that respond to button actions.

The standard dialog is *modal*, which means that no other window can be accessed before the dialog is dismissed. However, the custom dialogs derived from `JDialog` are not modal by default. To make a dialog modal, set its `modal` property to `true`. To display an instance of `JDialog`, set its `visible` property to `true`.

Let us create a custom dialog box for choosing colors, as shown in Figure 38.17(a). Use this dialog to choose the color for the foreground of the button, as shown in Figure 38.17(b). When the user clicks the *Change Button Text Color* button, the Choose Color dialog box is displayed.



**Figure 38.17**

*The custom dialog allows you to choose a color for the label's foreground.*

Create a custom dialog component named `ColorDialog` by extending `JDialog`. Use three sliders to specify red, green, and blue components of a color. The program is given in Listing 38.6.

Listing 38.6 `ColorDialog.java`

```
<margin note line 8: color value>
<margin note line 12: sliders>
<margin note line 17: buttons>
<margin note line 23: constructor>
<margin note line 27: constructor>
<margin note line 29: create UI>
<margin note line 69: listeners>

1 import java.awt.*;
2 import java.awt.event.*;
3 import javax.swing.*;
4 import javax.swing.event.*;
5
6 public class ColorDialog extends JDialog {
7 // Declare color component values and selected color
8 private int redValue, greenValue, blueValue;
9 private Color color = null;
10
11 // Create sliders
12 private JSlider jslRed = new JSlider(0, 128);
13 private JSlider jslGreen = new JSlider(0, 128);
14 private JSlider jslBlue = new JSlider(0, 128);
15
16 // Create two buttons
17 private JButton jbtOK = new JButton("OK");
18 private JButton jbtCancel = new JButton("Cancel");
19
20 // Create a panel to display the selected color
21 private JPanel jpSelectedColor = new JPanel();
22
23 public ColorDialog() {
24 this(null, true);
25 }
26
27 public ColorDialog(java.awt.Frame parent, boolean modal) {
28 super(parent, modal);
29 setTitle("Choose Color");
30
31 // Group two buttons OK and Cancel
32 JPanel jpButtons = new JPanel();
33 jpButtons.add(jbtOK);
34 jpButtons.add(jbtCancel);
35
36 // Group labels
37 JPanel jpLabels = new JPanel();
38 jpLabels.setLayout(new GridLayout(3, 0));
39 jpLabels.add(new JLabel("Red"));
40 jpLabels.add(new JLabel("Green"));
41 jpLabels.add(new JLabel("Blue"));
42
43 // Group sliders for selecting red, green, and blue colors
44 JPanel jpSliders = new JPanel();
45 jpSliders.setLayout(new GridLayout(3, 0));
46 jpSliders.add(jslRed);
```

```

47 jpSliders.add(jslGreen);
48 jpSliders.add(jslBlue);
49
50 // Group jpLabels and jpSliders
51 JPanel jpSelectColor = new JPanel();
52 jpSelectColor.setLayout(new BorderLayout());
53 jpSelectColor.setBorder(
54 BorderFactory.createTitledBorder("Select Color"));
55 jpSelectColor.add(jpLabels, BorderLayout.WEST);
56 jpSelectColor.add(jpSliders, BorderLayout.CENTER);
57
58 // Group jpSelectColor and jpSelectedColor
59 JPanel jpColor = new JPanel();
60 jpColor.setLayout(new BorderLayout());
61 jpColor.add(jpSelectColor, BorderLayout.SOUTH);
62 jpColor.add(jpSelectedColor, BorderLayout.CENTER);
63
64 // Place jpButtons and jpColor into the dialog box
65 add(jpButtons, BorderLayout.SOUTH);
66 add(jpColor, BorderLayout.CENTER);
67 pack();
68
69 jbtOK.addActionListener(new ActionListener() {
70 @Override
71 public void actionPerformed(ActionEvent e) {
72 setVisible(false);
73 }
74 });
75
76 jbtCancel.addActionListener(new ActionListener() {
77 @Override
78 public void actionPerformed(ActionEvent e) {
79 color = null;
80 setVisible(false);
81 }
82 });
83
84 jslRed.addChangeListener(new ChangeListener() {
85 @Override
86 public void stateChanged(ChangeEvent e) {
87 redValue = jslRed.getValue();
88 color = new Color(redValue, greenValue, blueValue);
89 jpSelectedColor.setBackground(color);
90 }
91 });
92
93 jslGreen.addChangeListener(new ChangeListener() {
94 @Override
95 public void stateChanged(ChangeEvent e) {
96 greenValue = jslGreen.getValue();
97 color = new Color(redValue, greenValue, blueValue);
98 jpSelectedColor.setBackground(color);
99 }
100 });
101
102 jslBlue.addChangeListener(new ChangeListener() {
103 @Override
104 public void stateChanged(ChangeEvent e) {
105 blueValue = jslBlue.getValue();

```

```

106 color = new Color(redValue, greenValue, blueValue);
107 jpSelectedColor.setBackground(color);
108 }
109 });
110 }
111
112 @Override
113 public Dimension getPreferredSize() {
114 return new java.awt.Dimension(200, 200);
115 }
116
117 /** Return color */
118 public Color getColor() {
119 return color;
120 }
121 }

```

Create a test class to use the color dialog to select the color for the foreground color of the button in Listing 38.7.

**Listing 38.7 TestColorDialog.java**

*<margin note line 12: listener>*

*<margin note line 22: main method omitted>*

```

1 import javax.swing.*;
2 import java.awt.*;
3 import java.awt.event.*;
4
5 public class TestColorDialog extends JApplet {
6 private ColorDialog colorDialog1 = new ColorDialog();
7 private JButton jbtChangeColor = new JButton("Choose color");
8
9 public TestColorDialog() {
10 setLayout(new java.awt.FlowLayout());
11 jbtChangeColor.setText("Change Button Text Color");
12 jbtChangeColor.addActionListener(new ActionListener() {
13 @Override
14 public void actionPerformed(ActionEvent e) {
15 colorDialog1.setVisible(true);
16
17 if (colorDialog1.getColor() != null)
18 jbtChangeColor.setForeground(colorDialog1.getColor());
19 }
20 });
21 add(jbtChangeColor);
22 }
23 }

```

The custom dialog box allows the user to use the sliders to select colors. The selected color is stored in the `color` variable. When the user clicks the *Cancel* button, `color` becomes `null`, which implies that no selection has been made.

The dialog box is displayed when the user clicks the *Change Button Text Color* button and is closed when the *OK* button or the *Cancel* button is clicked.

**TIP:** Not setting the dialog modal when needed is a common mistake. In this example, the

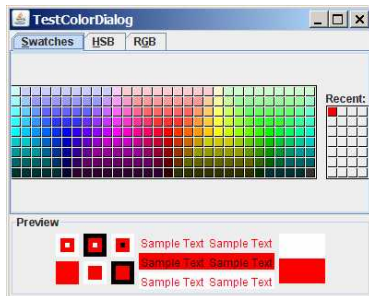
dialog is set modal in line 24 in `ColorDialog.java` (Listing 38.6). If the dialog is not modal, all the statements in the `Change Button Text Color` button handler are executed before the color is selected from the dialog box.

### 38.8 JColorChooser

You created a color dialog in the preceding example as a subclass of `JDialog`, which is a subclass of `java.awt.Dialog` (a top-level heavy-weight component). Therefore, it cannot be added to a container as a component. Color dialogs are commonly used in GUI programming. Swing provides a convenient and versatile color dialog named `javax.swing.JColorChooser`. `JColorChooser` is a lightweight component inherited from `JComponent`. It can be added to any container. For example, the following code places a `JColorChooser` in an applet, as shown in Figure 38.18.

*<margin note line 3: create JColorChooser>*

```
public class JColorChooserDemo extends javax.swing.JApplet {
 public JColorChooserDemo() {
 this.add(new javax.swing.JColorChooser());
 }
}
```



**Figure 38.18**

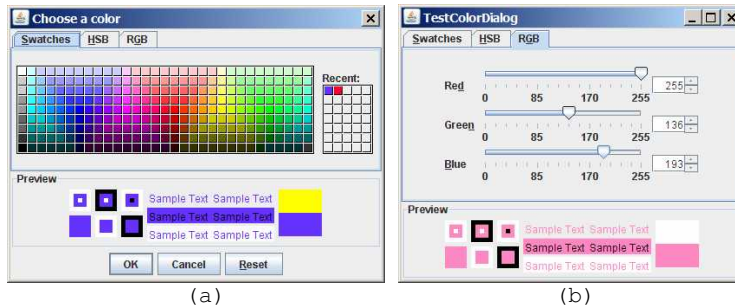
An instance of `JColorChooser` is displayed in an applet; (b)

Often an instance of `JColorChooser` is displayed in a dialog box using `JColorChooser`'s static `showDialog` method:

```
public static Color showDialog(Component parentComponent,
 String title,
 Color initialColor)
```

For example, the following code displays a `JColorChooser`, as shown in Figure 38.18.

```
Color color = JColorChooser.showDialog(this, "Choose a color",
 Color.YELLOW);
```



**Figure 38.19**

An instance of `JColorChooser` is displayed in a dialog box with the `OK`, `Cancel`, and `Reset` buttons.

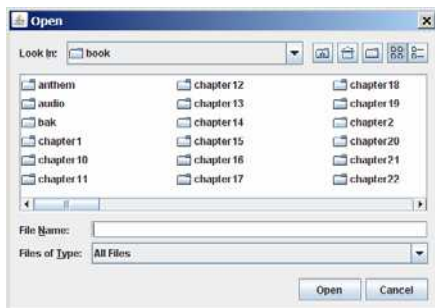
The `showDialog` method creates an instance of `JDialog` with three buttons, `OK`, `Cancel`, and `Reset`, to hold a `JColorChooser` object, as shown in Figure 38.19(a). The method displays a modal dialog. If the user clicks the `OK` button, the method dismisses the dialog and returns the selected color. If the user clicks the `Cancel` button or closes the dialog, the method dismisses the dialog and returns `null`.

`JColorChooser` consists of a tabbed pane and a color preview panel. The tabbed pane has three tabs for choosing colors using `Swatches`, `HSB`, and `RGB`, as shown in Figure 38.19(b). The preview panel shows the effect of the selected color.

NOTE: `JColorChooser` is very flexible. It allows you to replace the tabbed pane or the color preview panel with custom components. The default tabbed pane and the color preview panel are sufficient. You rarely need to use custom components.

### 38.9 `JFileChooser`

The `javax.swing.JFileChooser` class displays a dialog box from which the user can navigate through the file system and select files for loading or saving, as shown in Figure 38.20.



**Figure 38.20**

The Swing `JFileChooser` shows files and directories, and enables the user to navigate through the file system visually.

Like `JColorChooser`, `JFileChooser` is a lightweight component inherited from `JComponent`. It can be added to any container if

desired, but often you create an instance of JFileChooser and display it standalone.

JFileChooser is a subclass of JComponent. There are several ways to construct a file dialog box. The simplest is to use JFileChooser's no-arg constructor.

The file dialog box can appear in two types: open and save. The *open type* is for opening a file, and the *save type* is for storing a file. To create an open file dialog, use the following method:

```
public int showOpenDialog(Component parent)
```

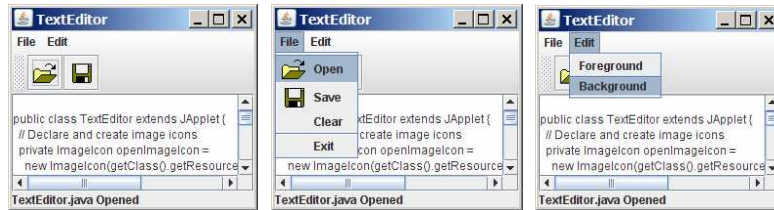
This method creates a dialog box that contains an instance of JFileChooser for opening a file. The method returns an int value, either APPROVE\_OPTION or CANCEL\_OPTION, which indicates whether the *Open* button or the *Cancel* button was clicked. Similarly, you can use the following method to create a dialog for saving files:

```
public int showSaveDialog(Component parent)
```

The file dialog box created with showOpenDialog or showSaveDialog is modal. The JFileChooser class has the properties inherited from JComponent. It also has the following useful properties:

- **dialogType** specifies the type of this dialog. Use OPEN\_DIALOG when you want to bring up a file chooser that the user can use to open a file. Likewise, use SAVE\_DIALOG to let the user choose a file for saving.
- **dialogTitle** is the string that is displayed in the title bar of the dialog box.
- **currentDirectory** is the current directory of the file. The type of this property is java.io.File. If you want the current directory to be used, use setCurrentDirectory(new File(".")).
- **selectedFile** is the file you have selected. You can use getSelectedFile() to return the selected file from the dialog box. The type of this property is java.io.File. If you have a default file name that you expect to use, use setSelectedFile(new File(filename)).
- **multiSelectionEnabled** is a boolean value indicating whether multiple files can be selected. By default, it is false.
- **selectedFiles** is a list of the files selected if the file chooser is set to allow multi-selection. The type of this property is File[].

Let us create an example of a simple text editor that uses Swing menus, toolbar, file chooser, and color chooser, as shown in Figure 38.21, which allows the user to open and save text files, clear text, and change the color and font of the text. Listing 38.8 shows the program.



**Figure 38.21**

The editor enables you to open and save text files from the File menu or from the toolbar, and to change the color and font of the text from the Edit menu.

**Listing 38.8 TextEditor.java**

```

1 import java.io.*;
2 import java.awt.*;
3 import java.awt.event.*;
4 import javax.swing.*;
5
6 public class TextEditor extends JApplet {
7 // Declare and create image icons
8 private ImageIcon openImageIcon =
9 new ImageIcon(getClass().getResource("/image/open.gif"));
10 private ImageIcon saveImageIcon =
11 new ImageIcon(getClass().getResource("/image/save.gif"));
12
13 // Create menu items
14 private JMenuItem jmiOpen = new JMenuItem("Open", openImageIcon);
15 private JMenuItem jmiSave = new JMenuItem("Save", saveImageIcon);
16 private JMenuItem jmiClear = new JMenuItem("Clear");
17 private JMenuItem jmiExit = new JMenuItem("Exit");
18 private JMenuItem jmiForeground = new JMenuItem("Foreground");
19 private JMenuItem jmiBackground = new JMenuItem("Background");
20
21 // Create buttons to be placed in a tool bar
22 private JButton jbtOpen = new JButton(openImageIcon);
23 private JButton jbtSave = new JButton(saveImageIcon);
24 private JLabel lblStatus = new JLabel();
25
26 // Create a JFileChooser with the current directory
27 private JFileChooser jFileChooser1
28 = new JFileChooser(new File("."));
29
30 // Create a text area
31 private JTextArea jta = new JTextArea();
32
33 public TextEditor() {
34 // Add menu items to the menu
35 JMenu jMenu1 = new JMenu("File");
36 jMenu1.add(jmiOpen);
37 jMenu1.add(jmiSave);
38 jMenu1.add(jmiClear);
39 jMenu1.addSeparator();
40 jMenu1.add(jmiExit);
41

```



```

42 // Add menu items to the menu
43 JMenu jMenuItem2 = new JMenu("Edit");
44 jMenuItem2.add(jmiForeground);
45 jMenuItem2.add(jmiBackground);
46
47 // Add menus to the menu bar
48 JMenuBar jMenuItemBar1 = new JMenuBar();
49 jMenuItemBar1.add(jMenuItem1);
50 jMenuItemBar1.add(jMenuItem2);
51
52 // Set the menu bar
53 setJMenuBar(jMenuItemBar1);
54
55 // Create tool bar
56 JToolBar jMenuItemBar1 = new JToolBar();
57 jMenuItemBar1.add(jbtOpen);
58 jMenuItemBar1.add(jbtSave);
59
60 jMenuItemOpen.addActionListener(new ActionListener() {
61 @Override
62 public void actionPerformed(ActionEvent e) {
63 open();
64 }
65 });
66
67 jMenuItemSave.addActionListener(new ActionListener() {
68 @Override
69 public void actionPerformed(ActionEvent evt) {
70 save();
71 }
72 });
73
74 jMenuItemClear.addActionListener(new ActionListener() {
75 @Override
76 public void actionPerformed(ActionEvent evt) {
77 jta.setText(null);
78 }
79 });
80
81 jMenuItemExit.addActionListener(new ActionListener() {
82 @Override
83 public void actionPerformed(ActionEvent evt) {
84 System.exit(0);
85 }
86 });
87
88 jMenuItemForeground.addActionListener(new ActionListener() {
89 @Override
90 public void actionPerformed(ActionEvent evt) {
91 Color selectedColor =
92 JColorChooser.showDialog(null, "Choose Foreground Color",
93 jta.getForeground());
94
95 if (selectedColor != null)
96 jta.setForeground(selectedColor);
97 }
98 });
99
100 jMenuItemBackground.addActionListener(new ActionListener() {
101 @Override
102 public void actionPerformed(ActionEvent evt) {
103 Color selectedColor =
104 JColorChooser.showDialog(null, "Choose Background Color",
105 jta.getForeground());
106
107 if (selectedColor != null)

```

```

108 jta.setBackground(selectedColor);
109 }
110 });
111
112 jbtOpen.addActionListener(new ActionListener() {
113 @Override
114 public void actionPerformed(ActionEvent evt) {
115 open();
116 }
117 });
118
119 jbtSave.addActionListener(new ActionListener() {
120 @Override
121 public void actionPerformed(ActionEvent evt) {
122 save();
123 }
124 });
125
126 add(jToolBar1, BorderLayout.NORTH);
127 add(jlblStatus, BorderLayout.SOUTH);
128 add(new JScrollPane(jta), BorderLayout.CENTER);
129 }
130
131 /** Open file */
132 private void open() {
133 if (jFileChooser1.showOpenDialog(this) ==
134 JFileChooser.APPROVE_OPTION)
135 open(jFileChooser1.getSelectedFile());
136 }
137
138 /** Open file with the specified File instance */
139 private void open(File file) {
140 try {
141 // Read from the specified file and store it in jta
142 BufferedInputStream in = new BufferedInputStream(
143 new FileInputStream(file));
144 byte[] b = new byte[in.available()];
145 in.read(b, 0, b.length);
146 jta.append(new String(b, 0, b.length));
147 in.close();
148
149 // Display the status of the Open file operation in lblStatus
150 lblStatus.setText(file.getName() + " Opened");
151 }
152 catch (IOException ex) {
153 lblStatus.setText("Error opening " + file.getName());
154 }
155 }
156
157 /** Save file */
158 private void save() {
159 if (jFileChooser1.showSaveDialog(this) ==
160 JFileChooser.APPROVE_OPTION) {
161 save(jFileChooser1.getSelectedFile());
162 }
163 }
164
165 /** Save file with specified File instance */
166 private void save(File file) {
167 try {
168 // Write the text in jta to the specified file
169 BufferedOutputStream out = new BufferedOutputStream(
170 new FileOutputStream(file));
171 byte[] b = (jta.getText()).getBytes();
172 out.write(b, 0, b.length);
173 out.close();

```

```

174
175 // Display the status of the save file operation in jlblStatus
176 jlblStatus.setText(file.getName() + " Saved ");
177 }
178 catch (IOException ex) {
179 jlblStatus.setText("Error saving " + file.getName());
180 }
181 }
182 }

```

The program creates the File and Edit menus (lines 34-45). The File menu contains the menu commands Open for loading a file, Save for saving a file, Clear for clearing the text editor, and Exit for terminating the program. The Edit menu contains the menu commands Foreground Color and Background Color for setting foreground color and background color in the text. The Open and Save menu commands can also be accessed from the toolbar, which is created in lines 56-58. The status of executing Open and Save is displayed in the status label, which is created in line 24.

jFileChooser1, an instance of JFileChooser, is created for displaying the file dialog box to open and save files (lines 27-28). new File(".') is used to set the current directory to the directory where the class is stored.

The open method is invoked when the user clicks the Open menu command or the Open toolbar button (lines 62, 108). The showOpenDialog method (line 125) displays an Open dialog box, as shown in Figure 38.20. Upon receiving the selected file, the method open(file) (line 127) is invoked to load the file to the text area using a BufferedInputStream wrapped on a FileInputStream.

The save method is invoked when the user clicks the Save menu command or the Save toolbar button (lines 68, 114). The showSaveDialog method (line 151) displays a Save dialog box. Upon receiving the selected file, the method save(file) (line 153) is invoked to save the contents from the text area to the file, using a BufferedOutputStream wrapped on a FileOutputStream.

The color dialog is displayed using the static method showDialog (lines 87, 98) of JColorChooser. Thus you don't need to create an instance of JFileChooser. The showDialog method returns the selected color if the *OK* button is clicked after a color is selected.

## Chapter Summary

1. *Menus* make selection easier and are widely used in window applications. Java provides five classes that implement menus: JMenuBar, JMenu, JMenuItem, JCheckBoxMenuItem, and JRadioButtonMenuItem. These classes are subclasses of AbstractButton. They are very similar to buttons.
2. JMenuBar is a top-level menu component used to hold menus. A menu consists of *menu items* that the user can select (or toggle on or off). A menu item can be an instance of JMenuItem, JCheckBoxMenuItem, or JRadioButtonMenuItem. Menu items can be associated with icons, keyboard mnemonics, and keyboard accelerators. Menu items can be separated using separators.

3. A *popup menu*, also known as a *context menu*, is like a regular menu, but does not have a menu bar and can float anywhere on the screen. Creating a popup menu is similar to creating a regular menu. First, you create an instance of JPopupMenu, then you can add JMenuItem, JCheckBoxMenuItem, JRadioButtonMenuItem, and separators to the popup menu.
4. Customarily, you display a popup menu by pointing to a GUI component and clicking a certain mouse button, the so-called *popup trigger*. Popup triggers are system dependent. In Windows, the popup menu is displayed when the right mouse button is released. In Motif, the popup menu is displayed when the third mouse button is pressed and held down.
5. Swing provides the JToolBar class as the container to hold toolbar components. JToolBar uses BoxLayout to manage components. The components usually appear as icons. Since icons are not components, they cannot be placed into a toolbar directly. Instead you place buttons into the toolbar and set the icons on the buttons. An instance of JToolBar is like a regular container. Often it is placed in the north, west, or east of a container of BorderLayout.
6. Swing provides the Action interface, which can be used to create action objects for processing actions. Using Action objects, common action processing for menu items and toolbar buttons can be centralized and separated from the other application code.
7. The JOptionPane class contains the static methods for creating message dialogs, confirmation dialogs, input dialogs, and option dialogs. You can also create custom dialogs by extending the JDialog class.
8. Swing provides a convenient and versatile color dialog named javax.swing.JColorChooser. Like JOptionPane, JColorChooser is a lightweight component inherited from JComponent. It can be added to any container.
9. Swing provides the javax.swing.JFileChooser class that displays a dialog box from which the user can navigate through the file system and select files for loading or saving.

## Test Questions

Do the test questions for this chapter online at  
[www.cs.armstrong.edu/liang/intro9e/test.html](http://www.cs.armstrong.edu/liang/intro9e/test.html).

## Review Questions

### Section 38.2

- 38.1 How do you create a menu bar?
- 38.2 How do you create a submenu? How do you create a check-box menu item? How do you create a radio-button menu item?
- 38.3 How do you add a separator in a menu?

38.4 How do you set an icon and a text in a menu item? How do you associate keyboard mnemonics and accelerators in a menu item?

### Section 38.3

38.5 How do you create a popup menu? How do you show a popup menu?

38.6 Describe a popup trigger.

### Section 38.4

38.7 What is the layout manager used in JToolBar? Can you change the layout manager?

38.8 How do you add buttons into a JToolBar? How do you add a JToolBar into a frame or an applet?

### Section 38.5

38.9 What is the Action interface for?

38.10 How do you add an Action object to a JToolBar, JMenu, JButton, JRadioButton, and JCheckBox?

### Section 38.6

38.11 Describe the standard dialog boxes created using the JOptionPane class.

38.12 How do you create a message dialog? What are the message types? What is the button in the message dialog?

38.13 How do you create a confirmation dialog? What are the button option types?

38.14 How do you create an input dialog with a text field for entering input? How do you create a combo box dialog for selecting values as input? How do you create a list dialog for selecting values as input?

### Sections 38.7-38.10

38.15 How do you show an instance of JDialog? Is a standard dialog box created using the static methods in JOptionPane modal? Is an instance of JDialog modal?

38.16 How do you display an instance of JColorChooser? Is an instance of JColorChooser modal? How do you obtain the selected color?

38.17 How do you display an instance of JFileChooser? Is an instance of JFileChooser modal? How do you obtain the selected file? What is the return type for getSelectedFile() and getSelectedDirectory()? How do you set the current directory as the default directory for a JFileChooser dialog?

## Programming Exercises

### Sections 38.2-38.3

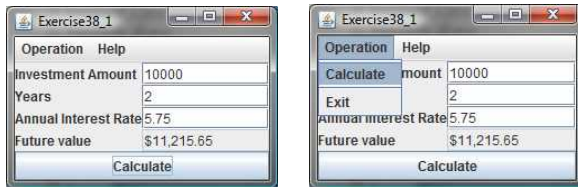
38.1\*

(Create an investment value calculator) Write a program that calculates the future value of an investment at a given interest rate for a specified number of years. The formula for the calculation is as follows:

$$\text{futureValue} = \text{investmentAmount} \times (1 + \text{monthlyInterestRate})^{\text{years} \times 12}$$

Use text fields for interest rate, investment amount, and years. Display the future amount in a text field when the user clicks the *Calculate* button or chooses *Calculate* from the *Operation*

menu (see Figure 38.22). Show a message dialog box when the user clicks the **About** menu item from the Help menu.

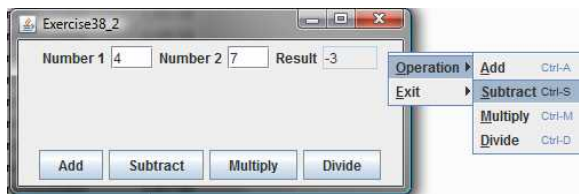


**Figure 38.22**

The user enters the investment amount, years, and interest rate to compute future value.

38.2\*

(Use popup menus) Modify Listing 38.1, MenuDemo.java, to create a popup menu that contains the menus Operations and Exit, as shown in Figure 38.23. The popup is displayed when you click the right mouse button on the panel that contains the labels and the text fields.



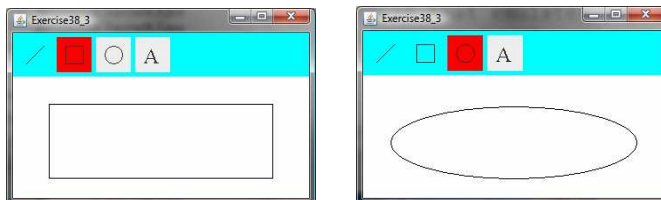
**Figure 38.23**

The popup menu contains the commands to perform arithmetic operations.

### Sections 38.4–38.5

38.3\*\*

(A paint utility) Write a program that emulates a paint utility. Your program should enable the user to choose options and draw shapes or get characters from the keyboard based on the selected options (see Figure 38.24). The options are displayed in a toolbar. To draw a line, the user first clicks the line icon in the toolbar and then uses the mouse to draw a line in the same way you would draw using Microsoft Paint.



**Figure 38.24**

This exercise produces a prototype drawing utility that enables you to draw lines, rectangles, ovals, and characters.

38.4\*

(Use *actions*) Write a program that contains the menu items and toolbar buttons that can be used to select flags to be displayed in an *ImageViewer*, as shown in Figure 38.25. Use the *Action* interface to centralize the processing for the actions.



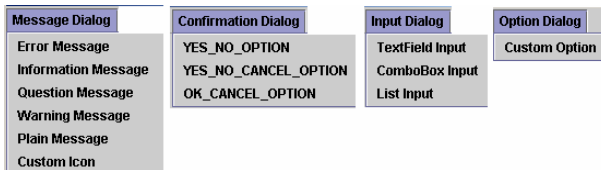
**Figure 38.25**

The menu items and tool buttons are used to display selected images in the *ImageViewer*.

### Sections 38.6–38.10

38.5\*

(Demonstrate *JOptionPane*) Write a program that creates option panes of all types, as shown in Figure 38.26. Each menu item invokes a static *showXxxDialog* method to display a dialog box.



**Figure 38.26**

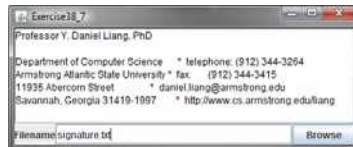
You can display a dialog box by clicking a menu item.

38.6\*

(Create *custom dialog*) Write a program that creates a custom dialog box to gather user information, as shown in Figure 38.27(a).



(a)



(b)

**Figure 38.27**

(a) The custom dialog box prompts the user to enter username and password. (b) The program enables the user to view a file by selecting it from a file open dialog box.

38.7\*

(Use *JFileChooser*) Write a program that enables the user to select a file from a file open dialog box. A file open dialog box is displayed when the *Browse* button is clicked, as shown in Figure 38.27(b). The file is displayed in the text area, and the

file name is displayed in the text field when the *OK* button is clicked in the file open dialog box. You can also enter the file name in the text field and press the *Enter* key to display the file in the text area.

### 38.8\*

(*Select an audio file*) Write a program that selects an audio file using the file dialog box, and use three buttons, *Play*, *Loop*, and *Stop*, to control the audio, as shown in Figure 38.28. If you click the *Play* button, the audio file is played once. If you click the *Loop* button, the audio file keeps playing repeatedly. If you click the *Stop* button, the playing stops. The selected audio files are stored in the folder named **anthems** under the exercise directory. The exercise directory contains the class file for this exercise.



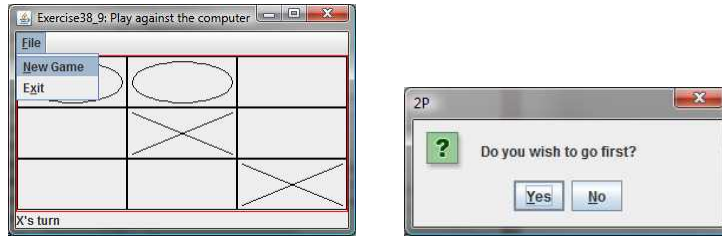
**Figure 38.28**

The program allows you to choose an audio file from a dialog box and use the buttons to play, repeatedly play, or stop the audio.

### 38.9\*\*

(*Play TicTacToe with a computer*) The game in §18.9, "Case Study: TicTacToe," facilitates two players. Write a new game that enables a player to play against the computer. Add a File menu with two items, New Game and Exit, as shown in Figure 38.29. When you click New Game, it displays a dialog box. From this dialog box, you can decide whether to let the computer go first.





**Figure 38.29**  
*The new TicTacToe game enables you to play against the computer.*

***\*\*\*This is a bonus Web chapter***

## **CHAPTER 39**

### **MVC and Swing Models**

#### **Objectives**

- To use the model-view-controller approach to separate data and logic from the presentation of data (§39.2).
- To implement the model-view-controller components using the JavaBeans event model (§39.2).
- To explain the Swing model-view-controller architecture (§39.4).
- To use JSpinner to scroll the next and previous values (§39.5).
- To create custom spinner models and editors (§39.6).
- To use JList to select single or multiple items in a list (§39.7).
- To add and remove items using ListModel and DefaultListModel (§39.8).
- To render list cells using a default or custom cell renderer (§39.9).
- To create custom combo box models and renderers (§39.10).

## 39.1 Introduction

The Swing user interface components are implemented using variations of the MVC architecture. You have used simple Swing components without concern for their supporting models, but in order to use advanced Swing components, you have to use their models to store, access, and modify data. This chapter introduces the MVC architecture and Swing models. Specifically, you will learn how to use the models in [JSpinner](#), [JList](#), and [JComboBox](#). The next chapter will introduce [JTable](#) and [JTree](#).

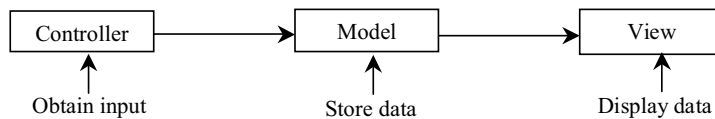
## 39.2 MVC

**<margin note: model>**

**<margin note: view>**

**<margin note: controller>**

The model-view-controller (MVC) approach is a way of developing components by separating data storage and handling from the visual representation of the data. The component for storing and handling data, known as a *model*, contains the actual contents of the component. The component for presenting the data, known as a *view*, handles all essential component behaviors. It is the view that comes to mind when you think of the component. It does all the displaying of the components. The *controller* is a component that is usually responsible for obtaining data, as shown in Figure 39.1.



**Figure 39.1**

*The controller obtains data and stores it in a model. The view displays the data stored in the model.*

**<margin note: MVC benefits>**

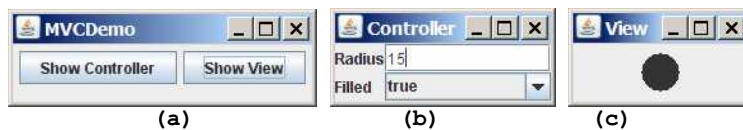
Separating a component into a model and a view has two major benefits:

- It makes multiple views possible so that data can be shared through the same model. For example, a model storing student names can be displayed simultaneously in a combo box and a list box.
- It simplifies the task of writing complex applications and makes the components scalable and easy to maintain. Changes can be made to the view without affecting the model, and vice versa.

A model contains data, whereas a view makes the data visible. Once a view is associated with a model, it is synchronized with the model. This ensures that all of the model's views display the same data consistently. To achieve consistency and synchronization with its dependent views, the model should notify the views when there is a change in any of its properties that are used in the view. In response to a change notification, the view is responsible for redisplaying the viewing area affected by the property change.

The Java event delegation model provides a superior architecture for supporting MVC component development. The model can be implemented as a source with appropriate event and event listener registration methods. The view can be implemented as a listener. Thus, if data are changed in the model, the view will be notified. To enable the selection of the model from the view, simply add the model as a property in the view with a set method.

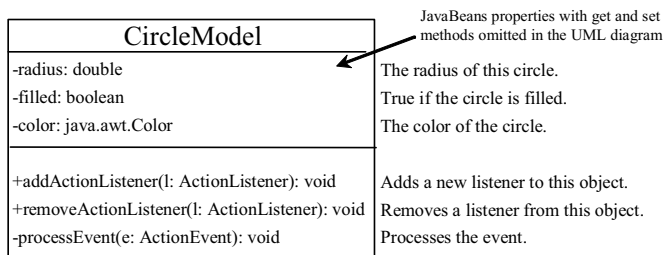
Let us use an example to demonstrate the development of components using the MVC approach. The example creates a model named `CircleModel`, a view named `CircleView`, and a controller named `CircleControl`. `CircleModel` stores the properties (`radius`, `filled`, and `color`) that describe a circle. `filled` is a boolean value that indicates whether a circle is filled. `CircleView` draws a circle according to the properties of the circle. `CircleControl` enables the user to enter circle properties from a graphical user interface. Create an applet with two buttons named `Show Controller` and `Show View`, as shown in Figure 39.2(a). When you click the `Show Controller` button, the controller is displayed in a frame, as shown in Figure 39.2(b). When you click the `Show View` button, the view is displayed in a separate frame, as shown in Figure 39.2(c).



**Figure 39.2**  
The controller obtains circle properties and stores them in a circle model. The view displays the circle specified by the circle model.

**<margin note: date model>**

The circle model contains the properties `radius`, `filled`, and `color`, as well as the registration/deregistration methods for action event, as shown in Figure 39.3.



**Figure 39.3**  
The circle model stores the data and notifies the listeners if the data change.

When a property value is changed, the listeners are notified. The complete source code for `CircleModel` is given in Listing 39.1.

**Listing 39.1 CircleModel.java**

**<margin note line 6: properties>**  
**<margin note line 25: fire event>**

<margin note line 37: fire event>  
<margin note line 49: fire event>  
<margin note line 54: standard code>  
<margin note line 62: standard code>  
<margin note line 68: standard code>

```
1 import java.awt.event.*;
2 import java.util.*;
3
4 public class CircleModel {
5 /** Property radius. */
6 private double radius = 20;
7
8 /** Property filled. */
9 private boolean filled;
10
11 /** Property color. */
12 private java.awt.Color color;
13
14 /** Utility field used by event firing mechanism. */
15 private ArrayList<ActionListener> actionListenerList;
16
17 public double getRadius() {
18 return radius;
19 }
20
21 public void setRadius(double radius) {
22 this.radius = radius;
23
24 // Notify the listener for the change on radius
25 processEvent(
26 new ActionEvent(this, ActionEvent.ACTION_PERFORMED, "radius"));
27 }
28
29 public boolean isFilled() {
30 return filled;
31 }
32
33 public void setFilled(boolean filled) {
34 this.filled = filled;
35
36 // Notify the listener for the change on filled
37 processEvent(
38 new ActionEvent(this, ActionEvent.ACTION_PERFORMED, "filled"));
39 }
40
41 public java.awt.Color getColor() {
42 return color;
43 }
44
45 public void setColor(java.awt.Color color) {
46 this.color = color;
47
48 // Notify the listener for the change on color
49 processEvent(
50 new ActionEvent(this, ActionEvent.ACTION_PERFORMED, "color"));
51 }
52
53 /** Register an action event listener */
54 public synchronized void addActionListener(ActionListener l) {
55 if (actionListenerList == null)
56 actionListenerList = new ArrayList<ActionListener>();
57
58 actionListenerList.add(l);
59 }

```

```

60
61 /** Remove an action event listener */
62 public synchronized void removeActionListener(ActionListener l) {
63 if (actionListenerList != null && actionListenerList.contains(l))
64 actionListenerList.remove(l);
65 }
66
67 /** Fire TickEvent */
68 private void processEvent(ActionEvent e) {
69 ArrayList<ActionListener> list;
70
71 synchronized (this) {
72 if (actionListenerList == null) return;
73 list = (ArrayList<ActionListener>)(actionListenerList.clone());
74 }
75
76 for (int i = 0; i < list.size(); i++) {
77 ActionListener listener = list.get(i);
78 listener.actionPerformed(e);
79 }
80 }
81 }

```

NOTE

The registration/deregistration/processEvent methods (lines 54-80) are the same as in lines 49-82 in Listing 27.2, `CourseWithActionEvent.java`. If you use a GUI builder tool such as NetBeans and Eclipse, the code can be generated automatically.

<margin note: view>

The UML diagram for `CircleView` is shown in Figure 39.4 and its source code is given in Listing 39.2. The view listens for notifications from the model. It contains the model as its property. When a model is set in the view, a listener is created and registered with the model (lines 13-17). The view extends `JPanel` and overrides the `paintComponent` method to draw the circle according to the property values specified in the model.

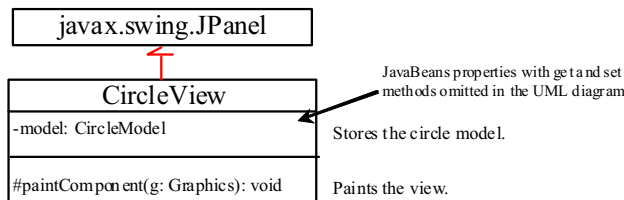


Figure 39.4

The view displays the circle according to the model.

Listing 39.2 `CircleView.java`

<margin note line 5: model>  
 <margin note line 8: set model>  
 <margin note line 26: paint view>

```

1 import java.awt.*;
2 import java.awt.event.*;
3
4 public class CircleView extends JPanel {
5 private CircleModel model;

```

```

6
7 /** Set a model */
8 public void setModel(CircleModel newModel) {
9 model = newModel;
10
11 if (model != null)
12 // Register the view as listener for the model
13 model.addActionListener(new ActionListener() {
14 @Override
15 public void actionPerformed(ActionEvent e) {
16 repaint();
17 }
18 });
19 }
20
21 public CircleModel getModel() {
22 return model;
23 }
24
25 @Override
26 protected void paintComponent(Graphics g) {
27 if (model != null) {
28 super.paintComponent(g);
29 g.setColor(model.getColor());
30
31 int xCenter = getWidth() / 2;
32 int yCenter = getHeight() / 2;
33 int radius = (int)model.getRadius();
34
35 if (model.isFilled()) {
36 g.fillOval(xCenter - radius, yCenter - radius,
37 2 * radius, 2 * radius);
38 }
39 else {
40 g.drawOval(xCenter - radius, yCenter - radius,
41 2 * radius, 2 * radius);
42 }
43 }
44 }
45 }

```

The controller presents a GUI interface that enables the user to enter circle properties radius and filled. It contains the model as its property. You can use the setModel method to associate a circle model with the controller. It uses a text field to obtain a new radius and a combo box to obtain a boolean value to specify whether the circle is filled. The source code for CircleController is given in Listing 39.3.

### Listing 39.3 CircleController.java

<margin note line 6: model>  
 <margin note line 14: create UI>  
 <margin note line 47: set model>

```

1 import java.awt.event.*;
2 import java.awt.*;
3 import javax.swing.*;
4
5 public class CircleController extends JPanel {

```

```

6 private CircleModel model;
7 private JTextField jtfRadius = new JTextField();
8 private JComboBox jcboFilled = new JComboBox(new Boolean[]{
9 new Boolean(false), new Boolean(true)});
10
11 /** Creates new form CircleController */
12 public CircleController() {
13 // Panel to group labels
14 JPanel panel1 = new JPanel();
15 panel1.setLayout(new GridLayout(2, 1));
16 panel1.add(new JLabel("Radius"));
17 panel1.add(new JLabel("Filled"));
18
19 // Panel to group text field, combo box, and another panel
20 JPanel panel2 = new JPanel();
21 panel2.setLayout(new GridLayout(2, 1));
22 panel2.add(jtfRadius);
23 panel2.add(jcboFilled);
24
25 setLayout(new BorderLayout());
26 add(panel1, BorderLayout.WEST);
27 add(panel2, BorderLayout.CENTER);
28
29 // Register listeners
30 jtfRadius.addActionListener(new ActionListener() {
31 @Override
32 public void actionPerformed(ActionEvent e) {
33 if (model != null) // Set radius in the model
34 model.setRadius(Double.parseDouble(jtfRadius.getText()));
35 }
36 });
37 jcboFilled.addActionListener(new ActionListener() {
38 @Override
39 public void actionPerformed(ActionEvent e) {
40 if (model != null) // Set filled property value in the model
41 model.setFilled(((Boolean)jcboFilled.getSelectedItem()).
42 booleanValue());
43 }
44 });
45 }
46
47 public void setModel(CircleModel newModel) {
48 model = newModel;
49 }
50
51 public CircleModel getModel() {
52 return model;
53 }
54 }

```

Finally, let us create an applet named `MVCDemo` with two buttons, *Show Controller* and *Show View*. The *Show Controller* button displays a controller in a frame, and the *Show View* button displays a view in a separate frame. The program is shown in Listing 39.4.

#### Listing 39.4 MVCDemo.java

```

<margin note line 8: create model>
<margin note line 11: create UI>
<margin note line 20: set model>
<margin note line 33: set model>
<margin note line 41: main method omitted>

```

```

1 import java.awt.*;

```



```

2 import java.awt.event.*;
3 import javax.swing.*;
4
5 public class MVCDemo extends JApplet {
6 private JButton jbtController = new JButton("Show Controller");
7 private JButton jbtView = new JButton("Show View");
8 private CircleModel model = new CircleModel();
9
10 public MVCDemo() {
11 setLayout(new FlowLayout());
12 add(jbtController);
13 add(jbtView);
14
15 jbtController.addActionListener(new ActionListener() {
16 @Override
17 public void actionPerformed(ActionEvent e) {
18 JFrame frame = new JFrame("Controller");
19 CircleController controller = new CircleController();
20 controller.setModel(model);
21 frame.add(controller);
22 frame.setSize(200, 200);
23 frame.setLocation(200, 200);
24 frame.setVisible(true);
25 }
26 });
27
28 jbtView.addActionListener(new ActionListener() {
29 @Override
30 public void actionPerformed(ActionEvent e) {
31 JFrame frame = new JFrame("View");
32 CircleView view = new CircleView();
33 view.setModel(model);
34 frame.add(view);
35 frame.setSize(500, 200);
36 frame.setLocation(200, 200);
37 frame.setVisible(true);
38 }
39 });
40 }
41 }

```

The model stores and handles data, and the views are responsible for presenting data. The fundamental issue in the model-view approach is to ensure consistency between the views and the model. Any change in the model should be notified to the dependent views, and all the views should display the same data consistently. The data in the model is changed through the controller.

The methods `setRadius`, `setFilled`, and `setColor` (lines 21, 33, 45) in `CircleModel` invoke the `processEvent` method to notify the listeners of any change in the properties.

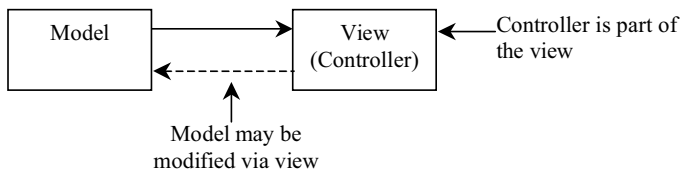
The `setModel` method in `CircleView` sets a new model and registers with a listener for the model by invoking the model's `addActionListener` method (line 13). When the data in the model are changed, the listener's `actionPerformed` method is invoked to repaint the circle (line 15).

The controller `CircleController` presents a GUI. You can enter the radius from the radius text field. You can specify whether the circle is filled from the combo box that contains two `Boolean` objects, `new Boolean(false)` and `new Boolean(true)` (lines 8-9).

In `MVCDemo`, every time you click the `Show Controller` button, a new controller is created (line 18). Every time you click the `Show View` button, a new view is created (line 30). The controller and view share the same model.

### 39.3 MVC Variations

A variation of the model-view-controller architecture combines the controller with the view. In this case, a view not only presents the data, but is also used as an interface to interact with the user and accept user input, as shown in Figure 39.5.



**Figure 39.5**

*The view can interact with the user as well as displaying data.*

For example, you can modify the view in the preceding example to enable the user to change the circle's radius using the mouse. When the left mouse button is clicked, the radius is increased by 5 pixels. When the right mouse button is clicked, the radius is decreased by 5 pixels. The new view, named `ViewController`, can be implemented by extending `CircleView`, as follows:

*<margin note line 6: mouse listener>*

*<margin note line 11: left button?>*

*<margin note line 13: right button?>*

```

1 import java.awt.event.MouseEvent;
2
3 public class ViewController extends CircleView {
4 public ViewController() {
5 // Register mouse listener
6 addMouseListener(new java.awt.event.MouseAdapter() {
7 public void mousePressed(java.awt.event.MouseEvent e) {
8 CircleModel model = getModel(); // Get model
9
10 if (model != null)
11 if (e.getButton() == MouseEvent.BUTTON1)
12 model.setRadius(model.getRadius() + 5); // Left button
13 else if (e.getButton() == MouseEvent.BUTTON3)
14 model.setRadius(model.getRadius() - 5); // Right button
15 }
16 });
17 }
18 }

```

Another variation of the model-view-controller architecture adds some of the data from the model to the view so that frequently used data can be accessed directly from the view. Swing components are designed using the MVC architecture. Each Swing GUI component is a view that uses a model to store data. A Swing GUI component contains some data in the model, so that it can be accessed directly from the component.

### 39.4 Swing Model-View-Controller Architecture

Every Swing user interface component (except some containers and dialog boxes, such as `JPanel`, `JSplitPane`, `JFileChooser`, and `JColorChooser`) has a property named `model` that refers to its data model. The data model is defined in an interface whose name ends with `Model`. For example, the model for button component is `ButtonModel`. Most model interfaces have a default implementation class, commonly named `DefaultX`, where `X` is its model interface name. For example, the default implementation class for `ButtonModel` is `DefaultButtonModel`. The relationship of a Swing component, its model interface, and its default model implementation class is illustrated in Figure 39.6.

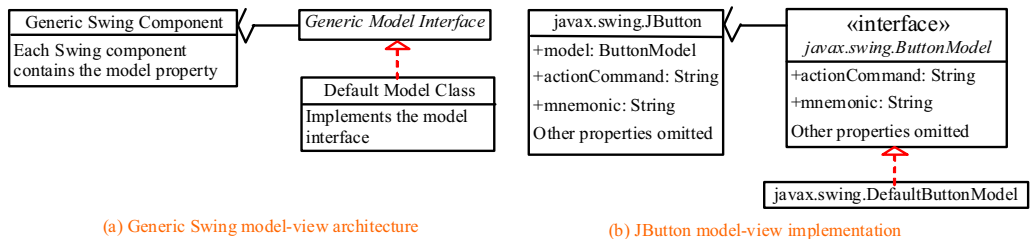


Figure 39.6

Swing components are implemented using the MVC architecture.

For convenience, most Swing components contain some properties of their models, and these properties can be accessed and modified directly from the component without the existence of the model being known. For example, the properties `actionCommand` and `mnemonic` are defined in both `ButtonModel` and `JButton`. Actually, these properties are in the `AbstractButton` class. Since `JButton` is a subclass of `AbstractButton`, it inherits all the properties from `AbstractButton`.

When you create a Swing component without specifying a model, a default data model is assigned to the `model` property. For example, lines 9-10 in the following code set the `actionCommand` and `mnemonic` properties of a button through its model.

*<margin note line 6: get model>*  
*<margin note line 9: set model properties>*

```

1 public class TestSwingModel1 {
2 public static void main(String[] args) {
3 javax.swing.JButton jbt = new javax.swing.JButton();
4
5 // Obtain the default model from the component
6 javax.swing.ButtonModel model = jbt.getModel();

```

```

7
8 // Set properties in the model
9 model.setActionCommand("OK");
10 model.setMnemonic('O');
11
12 // Display the property values from the component
13 System.out.println("actionCommand is " + jbt.getActionCommand());
14 System.out.println("mnemonic is " + (char)jbt.getMnemonic());
15 }
16 }

```

<Output>

```

actionCommand is OK
mnemonic is O

```

<End Output>

You can also create a new model and assign it to a Swing component. For example, the following code creates an instance of ButtonModel (line 7) and assigns it to an instance of JButton (line 14).

<margin note line 7: create model>

<margin note line 10: set model properties>

<margin note line 14: set a new model>

```

1 public class TestSwingModel2 {
2 public static void main(String[] args) {
3 javax.swing.JButton jbt = new javax.swing.JButton();
4
5 // Create a new button model
6 javax.swing.ButtonModel model =
7 new javax.swing.DefaultButtonModel();
8
9 // Set properties in the model
10 model.setActionCommand("Cancel");
11 model.setMnemonic('C');
12
13 // Assign the model to the button
14 jbt.setModel(model);
15
16 // Display the property values from the component
17 System.out.println("actionCommand is " + jbt.getActionCommand());
18 System.out.println("mnemonic is " + (char)jbt.getMnemonic());
19 }
20 }

```

<Output>

```

actionCommand is Cancel
mnemonic is C

```

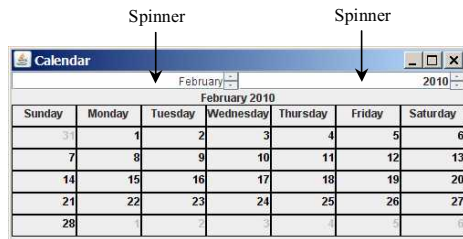
<End Output>

It is unnecessary to use the models for simple Swing components, such as JButton, JToggleButton, JCheckBox, JRadioButton, JTextField, and JTextArea, because the frequently used properties in the models of these Swing components are also the properties in these components. You can access and modify these properties directly through the components. For advanced components, such as

JSpinner, JList, JComboBox, JTable, and JTree, you have to work with their models to store, access, and modify data.

### 39.5 JSpinner

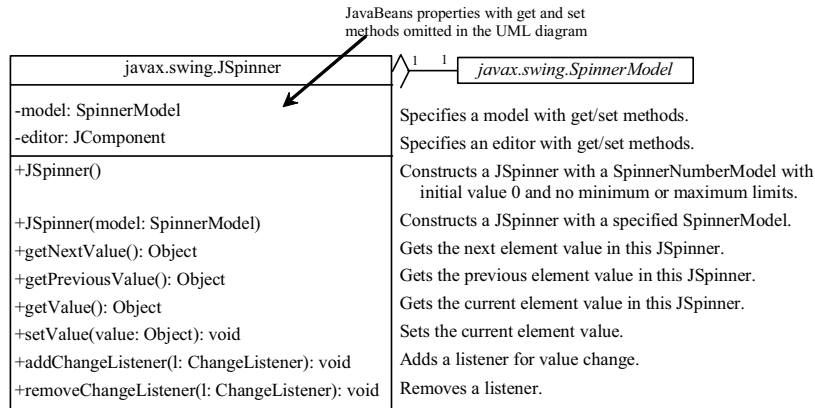
A spinner is a text field with a pair of tiny arrow buttons on its right side that enable the user to select numbers, dates, or values from an ordered sequence, as shown in Figure 39.7. The keyboard up/down arrow keys also cycle through the elements. The user may also be allowed to type a (legal) value directly into the spinner. A spinner is similar to a combo box but is sometimes preferred because it doesn't require a drop-down list that can obscure important data.



**Figure 39.7**

*Two JSpinner components enable the user to select a month and a year for the calendar.*

Figure 39.8 shows the constructors and commonly used methods in JSpinner. A JSpinner's sequence value is defined by the SpinnerModel interface, which manages a potentially unbounded sequence of elements. The model doesn't support indexed random access to sequence elements. Only three sequence elements are accessible at a time—current, next, and previous—using the methods getValue(), getNextValue(), and getPreviousValue(), respectively. The current sequence element can be modified using the setValue method. When the current value in a spinner is changed, the model invokes the stateChanged(javax.swing.event.ChangeEvent e) method of the registered listeners. The listeners must implement javax.swing.event.ChangeListener. All these methods in SpinnerModel are also defined in JSpinner for convenience, so you can access the data in the model from JSpinner directly.

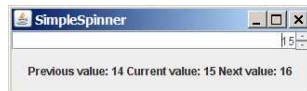


**Figure 39.8**

*JSpinner* uses a *spinner model* to store data.

NOTE: If you create a JSpinner object without specifying a model, the spinner displays a sequence of integers.

Listing 39.5 gives an example that creates a JSpinner object for a sequence of numbers and displays the previous, current, and next numbers from the spinner on a label, as shown in Figure 39.9.



**Figure 39.9**

The *previous*, *current*, and *next* values in the spinner are displayed on the label.

**Listing 39.5 SimpleSpinner.java**

<margin note line 7: spinner>  
 <margin note line 18: spinner listener>  
 <margin note line 27: main method omitted>

```

1 import javax.swing.*;
2 import javax.swing.event.*;
3 import java.awt.BorderLayout;
4
5 public class SimpleSpinner extends JApplet {
6 // Create a JSpinner
7 private JSpinner spinner = new JSpinner();
8
9 // Create a JLabel
10 private JLabel label = new JLabel("", JLabel.CENTER);
11
12 public SimpleSpinner() {
13 // Add spinner and label to the UI
14 add(spinner, BorderLayout.NORTH);
15 add(label, BorderLayout.CENTER);
16
17 // Register and create a listener

```

```

18 spinner.addChangeListener(new ChangeListener() {
19 @Override
20 public void stateChanged(javax.swing.event.ChangeEvent e) {
21 label.setText("Previous value: " + spinner.getPreviousValue()
22 + " Current value: " + spinner.getValue()
23 + " Next value: " + spinner.getNextValue());
24 }
25 });
26 }
27 }

```

A `JSpinner` object is created using its no-arg constructor (line 7). By default, a spinner displays a sequence of integers.

An anonymous inner class event adapter is created to process the value change event on the spinner (lines 18-25). The previous, current, and next values in a spinner can be obtained using the `JSpinner`'s instance methods `getPreviousValue()`, `getValue()`, and `getNextValue()`.

To display a sequence of values other than integers, you have to use spinner models.

### 39.6 Spinner Models and Editors

`SpinnerModel` is an interface for all spinner models. `AbstractSpinnerModel` is a convenient abstract class that implements `SpinnerModel` and provides the implementation for its registration/deregistration methods. `SpinnerListModel`, `SpinnerNumberModel`, and `SpinnerDateModel` are concrete implementations of `SpinnerModel`. The relationship among them is illustrated in Figure 39.10. Besides these models, you can create a custom spinner model that extends `AbstractSpinnerModel` or directly implements `SpinnerModel`.

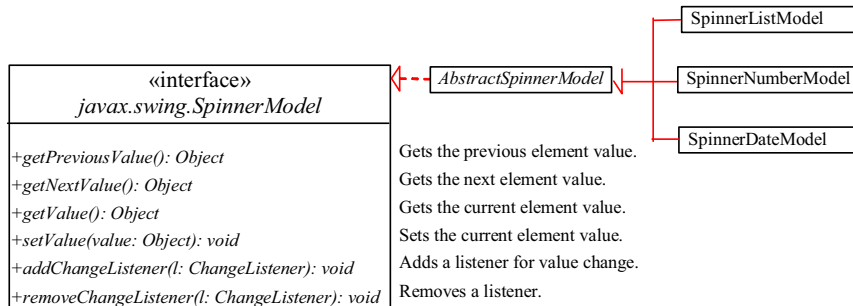
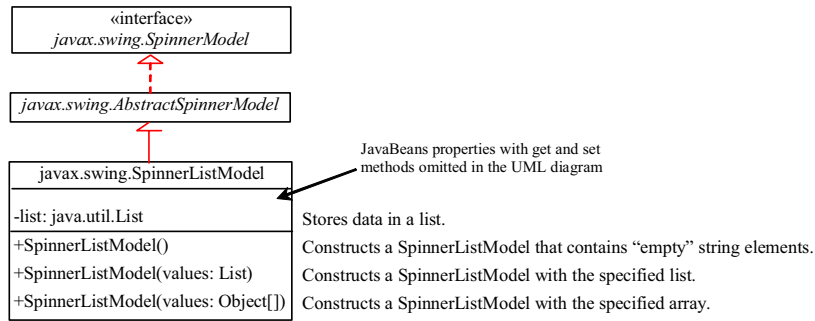


Figure 39.10

`SpinnerListModel`, `SpinnerNumberModel`, and `SpinnerDateModel` are concrete implementations for `SpinnerModel`.

#### 39.6.1 SpinnerListModel

`SpinnerListModel` (see Figure 39.11) is a simple implementation of `SpinnerModel` whose values are stored in a `java.util.List`.



**Figure 39.11**

*SpinnerListModel* uses a *java.util.List* to store a sequence of data in the model.

You can create a *SpinnerListModel* using an array or a list. For example, the following code creates a model that consists of values Freshman, Sophomore, Junior, Senior, and Graduate in an array.

```

// Create an array
String[] grades = {"Freshman", "Sophomore", "Junior",
 "Senior", "Graduate"};

// Create a model from an array
model = new SpinnerListModel(grades);

```

Alternatively, the following code creates a model using a list:

```

// Create an array
String[] grades = {"Freshman", "Sophomore", "Junior",
 "Senior", "Graduate"};

// Create an ArrayList from the array
list = new ArrayList(Arrays.asList(grades));

// Create a model from the list
model = new SpinnerListModel(list);

```

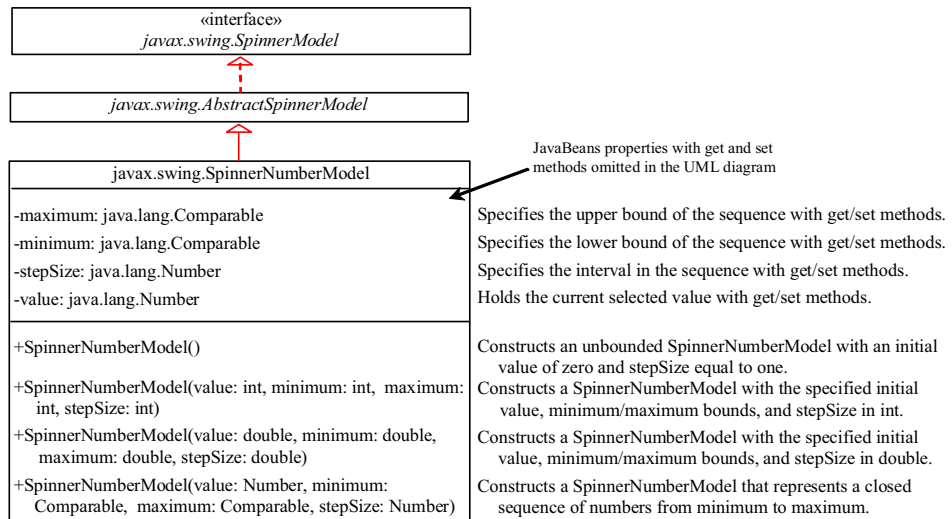
The alternative code seems unnecessary. However, it is useful if you need to add or remove elements from the model. The size of the array is fixed once the array is created. The list is a flexible data structure that enables you to add or remove elements dynamically.

### 39.6.2 *SpinnerNumberModel*

*SpinnerNumberModel* (see Figure 39.12) is a concrete implementation of *SpinnerModel* that represents a sequence of numbers. It contains the properties *maximum*, *minimum*, and *stepSize*. The *maximum* and *minimum* properties specify the upper and lower bounds of the sequence. The *stepSize* specifies the size of the increase or decrease computed by the *nextValue* and *previousValue* methods defined in *SpinnerModel*. The *minimum* and



maximum properties can be null to indicate that the sequence has no lower or upper limit. All of the properties in this class are defined as Number or Comparable, so that all Java numeric types may be accommodated.



**Figure 39.12**

*SpinnerNumberModel* represents a sequence of numbers.

You can create a SpinnerNumberModel with integers or double. For example, the following code creates a model that represents a sequence of numbers from 0 to 3000 with initial value 2004 and interval 1.

```
// Create a spinner number model
SpinnerNumberModel model = new SpinnerNumberModel(2004, 0, 3000, 1);
```

The following code creates a model that represents a sequence of numbers from 0 to 120 with initial value 50 and interval 0.1.

```
// Create a spinner number model
SpinnerNumberModel model = new SpinnerNumberModel(50, 0, 120, 0.1);
```

### 39.6.3 SpinnerDateModel

SpinnerDateModel (see Figure 39.13) is a concrete implementation of SpinnerModel that represents a sequence of dates. The upper and lower bounds of the sequence are defined by properties called start and end, and the size of the increase or decrease computed by the nextValue and previousValue methods is defined by a property called calendarField. The start and end properties can be null to indicate that the sequence has no lower or upper limit. The value of the calendarField property must be one of the java.util.Calendar constants that specify a field within a Calendar. The getNextValue and getPreviousValue methods change the date forward or backward by this amount. For example, if

`calendarField` is `Calendar.DAY_OF_WEEK`, then `nextValue` produces a date that is 24 hours after the current value, and `previousValue` produces a date that is 24 hours earlier.

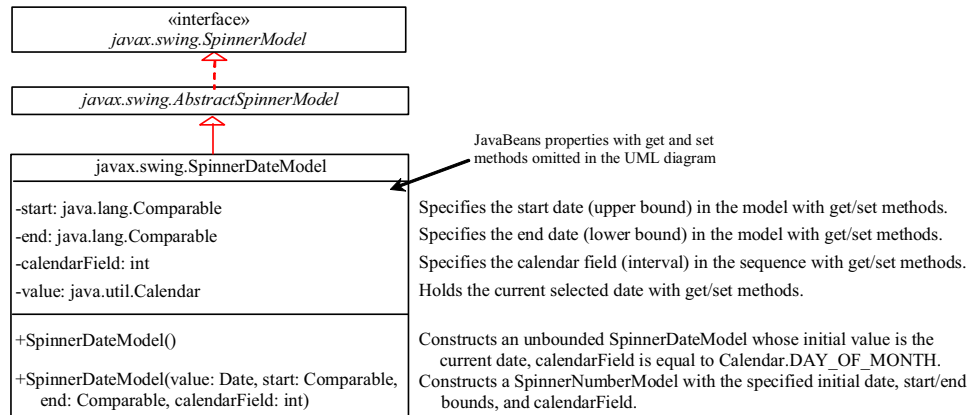


Figure 39.13

`SpinnerDateModel` represents a sequence of dates.

For example, the following code creates a spinner model that represents a sequence of dates, starting from the current date without a lower/upper limit and with calendar field on month.

```
SpinnerDateModel model = new SpinnerDateModel(
 new Date(), null, null, Calendar.MONTH);
```

#### 39.6.4 Spinner Editors

A `JSpinner` has a single child component, called the *editor*, which is responsible for displaying the current element or value of the model. Four editors are defined as static inner classes inside `JSpinner`.

- **`JSpinner.DefaultEditor`** is a simple base class for all other specialized editors to display a read-only view of the model's current value with a `JFormattedTextField`. `JFormattedTextField` extends `JTextField`, adding support for formatting arbitrary values, as well as retrieving a particular object once the user has edited the text.
- **`JSpinner.NumberEditor`** is a specialized editor for a `JSpinner` whose model is a `SpinnerNumberModel`. The value of the editor is displayed with a `JFormattedTextField` whose format is defined by a `NumberFormatter` instance.
- **`JSpinner.DateEditor`** is a specialized editor for a `JSpinner` whose model is a `SpinnerDateModel`. The value of the editor is displayed with a `JFormattedTextField` whose format is defined by a `DateFormatter` instance.
- **`JSpinner.ListEditor`** is a specialized editor for a `JSpinner` whose model is a `SpinnerListModel`. The value of the editor is displayed with a `JFormattedTextField`.

The `JSpinner`'s constructor creates a `NumberEditor` for `SpinnerNumberModel`, a `DateEditor` for `SpinnerDateModel`, a `ListEditor` for `SpinnerListModel`, and a `DefaultEditor` for all other models. The editor can also be changed using the `setEditor` method. The `JSpinner`'s editor stays in sync with the model by listening for `ChangeEvent`s. The `commitEdit()` method should be used to commit the currently edited value to the model.

### 39.6.5 Example: Using Spinner Models and Editors

This example uses a `JSpinner` component to display the date and three other `JSpinner` components to display the day in a sequence of numbers, the month in a sequence of strings, and the year in a sequence of numbers, as shown in Figure 39.14. All four components are synchronized. For example, if you change the year in the spinner for year, the date value in the date spinner is updated accordingly. The source code of the example is given in Listing 39.6.

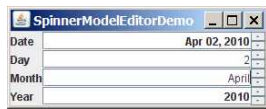


Figure 39.14

The four spinner components are synchronized to display the date in one field and the day, month, and year in three separate fields.

#### Listing 39.6 SpinnerModelEditorDemo.java

```

<margin note line 9: spinners>
<margin note line 20: create UI>
<margin note line 41: date editor>
<margin note line 46: number editor>
<margin note line 54: spinner listener>
<margin note line 62: spinner listener>
<margin note line 70: spinner listener>
<margin note line 109: main method omitted>

1 import javax.swing.*;
2 import javax.swing.event.*;
3 import java.util.*;
4 import java.text.*;
5 import java.awt.*;
6
7 public class SpinnerModelEditorDemo extends JApplet {
8 // Create four spinners for date, day, month, and year
9 private JSpinner jspDate =
10 new JSpinner(new SpinnerDateModel());
11 private JSpinner jspDay =
12 new JSpinner(new SpinnerNumberModel(1, 1, 31, 1));
13 private String[] monthNames = new DateFormatSymbols().getMonths();
14 private JSpinner jspMonth = new JSpinner
15 (new SpinnerListModel(Arrays.asList(monthNames).subList(0, 12)));
16 private JSpinner spinnerYear =
17 new JSpinner(new SpinnerNumberModel(2004, 1, 3000, 1));
18
19 public SpinnerModelEditorDemo() {
20 // Group labels
21 JPanel panell = new JPanel();

```

```

22 panell.setLayout(new GridLayout(4, 1));
23 panell.add(new JLabel("Date"));
24 panell.add(new JLabel("Day"));
25 panell.add(new JLabel("Month"));
26 panell.add(new JLabel("Year"));
27
28 // Group spinners
29 JPanel panel2 = new JPanel();
30 panel2.setLayout(new GridLayout(4, 1));
31 panel2.add(jspDate);
32 panel2.add(jspDay);
33 panel2.add(jspMonth);
34 panel2.add(spinnerYear);
35
36 // Add spinner and label to the UI
37 add(panell, BorderLayout.WEST);
38 add(panel2, BorderLayout.CENTER);
39
40 // Set editor for date
41 JSpinner.DateEditor dateEditor =
42 new JSpinner.DateEditor(jspDate, "MMM dd, yyyy");
43 jspDate.setEditor(dateEditor);
44
45 // Set editor for year
46 JSpinner.NumberEditor yearEditor =
47 new JSpinner.NumberEditor(spinnerYear, "####");
48 spinnerYear.setEditor(yearEditor);
49
50 // Update date to synchronize with the day, month, and year
51 updateDate();
52
53 // Register and create a listener for jspDay
54 jspDay.addChangeListener(new ChangeListener() {
55 @Override
56 public void stateChanged(javax.swing.event.ChangeEvent e) {
57 updateDate();
58 }
59 });
60
61 // Register and create a listener for jspMonth
62 jspMonth.addChangeListener(new ChangeListener() {
63 @Override
64 public void stateChanged(javax.swing.event.ChangeEvent e) {
65 updateDate();
66 }
67 });
68
69 // Register and create a listener for spinnerYear
70 spinnerYear.addChangeListener(new ChangeListener() {
71 @Override
72 public void stateChanged(javax.swing.event.ChangeEvent e) {
73 updateDate();
74 }
75 });
76 }
77
78 /** Update date spinner to synchronize with the other spinners */
79 private void updateDate() {
80 // Get current month and year in int
81 int month = ((SpinnerListModel)jspMonth.getModel()).
82 getList().indexOf(jspMonth.getValue());
83 int year = ((Integer)spinnerYear.getValue()).intValue();
84
85 // Set a new maximum number of days for the new month and year
86 SpinnerNumberModel numberModel =
87 (SpinnerNumberModel)jspDay.getModel();

```

```

88 numberModel.setMaximum(new Integer(maxDaysInMonth(year, month)));
89
90 // Set a new current day if it exceeds the maximum
91 if (((Integer)(numberModel.getValue())).intValue() >
92 maxDaysInMonth(year, month))
93 numberModel.setValue(new Integer(maxDaysInMonth(year, month)));
94
95 // Get the current day
96 int day = ((Integer)jspDay.getValue()).intValue();
97
98 // Set a new date in the date spinner
99 jspDate.setValue(
100 new GregorianCalendar(year, month, day).getTime());
101 }
102
103 /** Return the maximum number of days in a month. For example,
104 Feb 2004 has 29 days. */
105 private int maxDaysInMonth(int year, int month) {
106 Calendar calendar = new GregorianCalendar(year, month, 1);
107 return calendar.getActualMaximum(Calendar.DAY_OF_MONTH);
108 }
109 }

```

A JSpinner object for dates, jspDate, is created with a default SpinnerDateModel (lines 9-10). The format of the date displayed in the spinner is MMM dd, yyyy (e.g., Feb 01, 2006). This format is created using the JSpinner's inner class constructor DateEditor (lines 41-42) and is set as jspDate's editor (line 43).

A JSpinner object for days, jspDay, is created with a SpinnerNumberModel with a sequence of integers between 1 and 31 in which the initial value is 1 and the interval is 1 (lines 11-12). The maximum number is reset in the updateDate() method based on the current month and year (lines 91-93). For example, February 2004 has 29 days, so the maximum in jspDay is set to 29 for February 2004.

A JSpinner object for months, jspMonth, is created with a SpinnerListModel with a list of month names (lines 14-15). Month names are locale specific and can be obtained using the new DateFormatSymbols().getMonths() (line 13). Some calendars can have 13 months. Arrays.asList(monthNames) creates a list from an array of strings, and subList(0, 12) returns the first 12 elements in the list.

A JSpinner object for years, spinnerYear, is created with a SpinnerNumberModel with a sequence of integers between 1 and 3000 in which the initial value is 2004 and the interval is 1 (lines 16-17). By default, locale-specific number separators are used. For example, 2004 would be displayed as 2,004 in the spinner. To display the number without separators, the number pattern ##### is specified to construct a new NumberEditor for spinnerYear (lines 46-47). The editor is set as spinnerYear's editor (line 48).

The updateDate() method synchronizes the date spinner with the day, month, and year spinners. Whenever a new value is selected in the day, month, or year spinner, a new date is set in the date spinner. The maxDaysInMonth method (lines 105-108) returns the maximum number of days in a month. For example, February 2004 has 29 days.

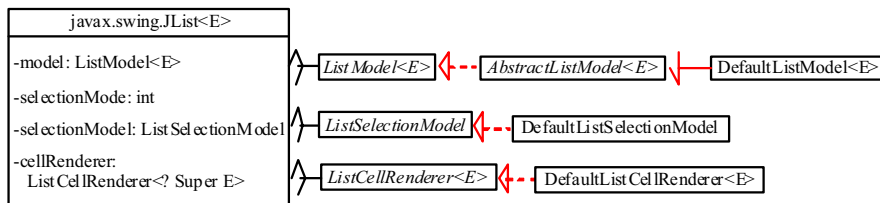
A `JSpinner` object can fire `javax.swing.event.ChangeEvent` to notify the listeners of the state change in the spinner. The anonymous event adapters are created to process spinner state changes for the day, month, and year spinners (lines 54-75). Whenever a new value is selected in one of these three spinners, the date spinner value is updated accordingly. In Exercise 39.3, you will improve the example to synchronize the day, month, and year spinners with the date spinner. Then, when a new value is selected in the date spinner, the values in the day, month, and year spinners will be updated accordingly.

This example uses `SpinnerNumberModel`, `SpinnerDateModel`, and `SpinnerListModel`. They are predefined concrete spinner models in the API. You can also create custom spinner models (see Exercise 39.4).

### 39.7 `JList` and its Models

The basic features of `JList` were introduced in §17.9, “Lists,” without using list models. You learned how to create a list and how to respond to list selections. However, you cannot add or remove elements from a list without using list models. This section introduces list models and gives a detailed discussion on how to use `JList`.

`JList` has two supporting models: a list model and a list-selection model. The *list model* is for storing and processing data. The *list-selection model* is for selecting items. By default, items are rendered as strings or icons. You can also define a custom renderer that implements the `ListCellRenderer` interface. The relationship of these interfaces and classes is shown in Figure 39.15.



**Figure 39.15**

`JList` contains several supporting interfaces and classes.

NOTE

**<margin note: JDK 7 new features>**

Since JDK 7, `JList`, `ListModel`, `AbstractListModel`, `DefaultListModel`, `ListCellRenderer`, and `DefaultListCellRenderer` have been redefined as generic classes and interfaces. The generic type `E` represents the element type stored in the list.

### 39.7.1 JList Constructors, Properties, and Methods

Figure 39.16 shows the properties and constructors of JList. You can create a list from a list model, an array of objects, or a vector.

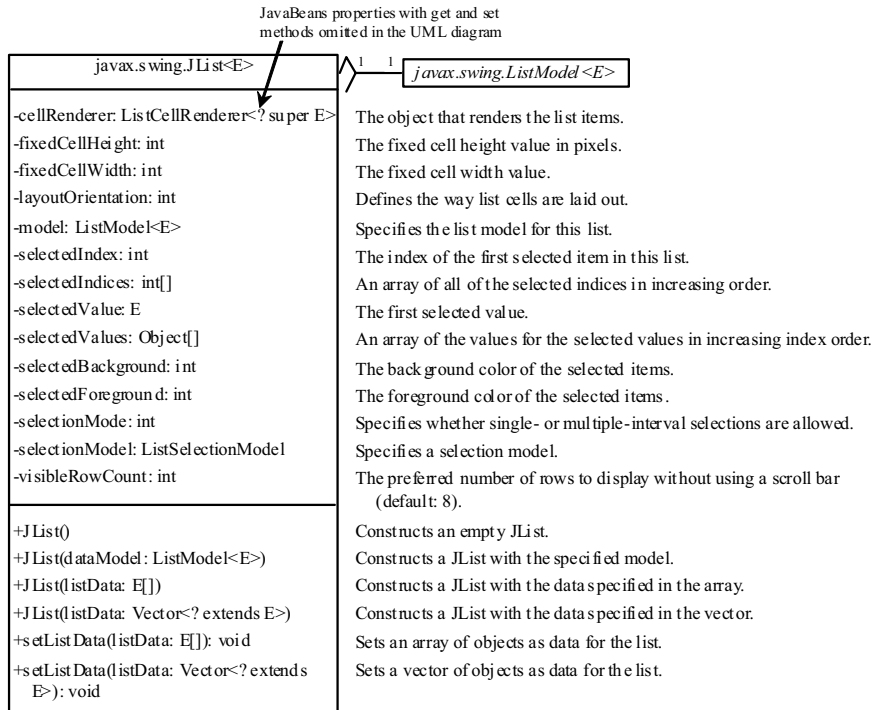


Figure 39.16

JList displays elements in a list.

### 39.7.2 List Layout Orientations

The **layoutOrientation** property specifies the layout of the items using one of the following three values:

JList.VERTICAL specifies that the cells should be laid out vertically in one column. This is the default value.

JList.HORIZONTAL\_WRAP specifies that the cells should be laid out horizontally, wrapping to a new row as necessary. The number of rows to use is determined by the visibleRowCount property if its value is greater than 0; otherwise the number of rows is determined by the width of the JList.

JList.VERTICAL\_WRAP specifies that the cells should be laid out vertically, wrapping to a new column as necessary. The number of rows to use is determined by the visibleRowCount property if its value is greater than 0; otherwise the number of rows is determined by the height of the JList.

For example, suppose there are five elements (item1, item2, item3, item4, and item5) in the list and the `visibleRowCount` is 2. Figure 39.17 shows the layout in these three cases.

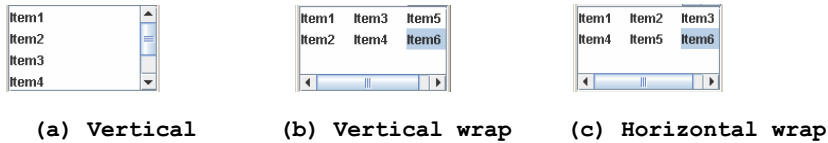
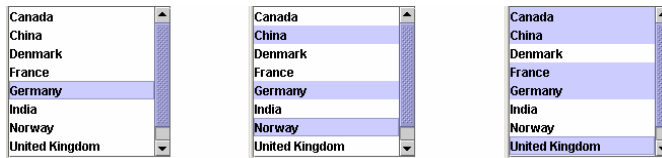


Figure 39.17

*Layout orientation specifies how elements are laid out in a list.*

### 39.7.3 List-Selection Modes and List-Selection Models

The `selectionMode` property is one of the three values (`SINGLE SELECTION`, `SINGLE INTERVAL SELECTION`, `MULTIPLE INTERVAL SELECTION`) that indicate whether a single item, single-interval item, or multiple-interval item can be selected, as shown in Figure 39.18. Single selection allows only one item to be selected. Single-interval selection allows multiple selections, but the selected items must be contiguous. These items can be selected all together by holding down the `SHIFT` key. Multiple-interval selection allows selections of multiple contiguous items without restrictions. These items can be selected by holding down the `Ctrl` key. The default value is `MULTIPLE INTERVAL SELECTION`.



(a) Single-selection (b) Single-interval selection (c) Multiple-interval selection

Figure 39.18

*A list has three selection modes.*

The `selectionModel` property specifies an object that tracks list selection. `JList` has two models: a list model and a list-selection model. *List models* handle data management, and *list-selection models* deal with data selection. A list-selection model must implement the `ListSelectionModel` interface, which defines constants for three selection modes (`SINGLE SELECTION`, `SINGLE INTERVAL SELECTION`, and `MULTIPLE INTERVAL SELECTION`), and registration methods for `ListSelectionListener`. It also defines the methods for adding and removing selection intervals, and the access methods for the properties, such as `selectionMode`, `anchorSelectionIndex`, `leadSelectionIndex`, and `valueIsAdjusting`.

By default, an instance of `JList` uses `DefaultListSelectionModel`, which is a concrete implementation of `ListSelectionModel`. Usually, you do not need to provide a custom list-selection



model, because the `DefaultListSelectionModel` class is sufficient in most cases. List-selection models are rarely used explicitly, because you can set the selection mode directly in `JList`.

#### 39.7.4 Example: List Properties Demo

This example creates a list of a fixed number of items displayed as strings. The example enables you to dynamically set `visibleRowCount` from a spinner, `layoutOrientation` from a combo box, and `selectionMode` from a combo box, as shown in Figure 39.19. When you select one or more items, their values are displayed in a status label below the list. The source code of the example is given in Listing 39.7.

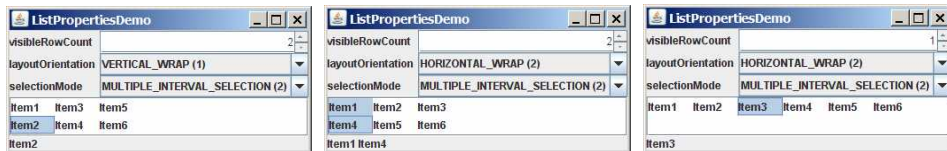


Figure 39.19

You can dynamically set the properties for `visibleRowCount`, `layoutOrientation`, and `selectionMode` in a list.

#### Listing 39.7 ListPropertiesDemo.java

```

<margin note line 7: list>
<margin note line 9: spinner>
<margin note line 11: combo box>
<margin note line 14: combo box>
<margin note line 22: create UI>
<margin note line 53: spinner listener>
<margin note line 61: combo box listener>
<margin note line 69: combo box listener>
<margin note line 77: list listener>
<margin note line 91: main method omitted>

1 import java.awt.*;
2 import java.awt.event.*;
3 import javax.swing.*;
4 import javax.swing.event.*;
5
6 public class ListPropertiesDemo extends JApplet {
7 private JList<String> jlst = new JList<String>(new String[] {
8 "Item1", "Item2", "Item3", "Item4", "Item5", "Item6"});
9 private JSpinner jspVisibleRowCount =
10 new JSpinner(new SpinnerNumberModel(8, -1, 20, 1));
11 private JComboBox jcbLayoutOrientation =
12 new JComboBox(new String[] {"VERTICAL (0)",
13 "VERTICAL_WRAP (1)", "HORIZONTAL_WRAP (2)"});
14 private JComboBox jcbSelectionMode =
15 new JComboBox(new String[] {"SINGLE_SELECTION (0)",
16 "SINGLE_INTERVAL_SELECTION (1)",
17 "MULTIPLE_INTERVAL_SELECTION (2)"});
18 private JLabel jlblStatus = new JLabel();
19
20 /** Construct the applet */

```

```

21 public ListPropertiesDemo() {
22 // Place labels in a panel
23 JPanel panel1 = new JPanel();
24 panel1.setLayout(new GridLayout(3, 1));
25 panel1.add(new JLabel("visibleRowCount"));
26 panel1.add(new JLabel("layoutOrientation"));
27 panel1.add(new JLabel("selectionMode"));
28
29 // Place text fields in a panel
30 JPanel panel2 = new JPanel();
31 panel2.setLayout(new GridLayout(3, 1));
32 panel2.add(jspVisibleRowCount);
33 panel2.add(jcboLayoutOrientation);
34 panel2.add(jcboSelectionMode);
35
36 // Place panel1 and panel2
37 JPanel panel3 = new JPanel();
38 panel3.setLayout(new BorderLayout(5, 5));
39 panel3.add(panel1, BorderLayout.WEST);
40 panel3.add(panel2, BorderLayout.CENTER);
41
42 // Place elements in the applet
43 add(panel3, BorderLayout.NORTH);
44 add(new JScrollPane(jlst), BorderLayout.CENTER);
45 add(jlblStatus, BorderLayout.SOUTH);
46
47 // Set initial property values
48 jlst.setFixedCellWidth(50);
49 jlst.setFixedCellHeight(20);
50 jlst.setSelectionMode(ListSelectionModel.SINGLE_SELECTION);
51
52 // Register listeners
53 jspVisibleRowCount.addChangeListener(new ChangeListener() {
54 @Override
55 public void stateChanged(ChangeEvent e) {
56 jlst.setVisibleRowCount(
57 ((Integer)jspVisibleRowCount.getValue()).intValue());
58 }
59 });
60
61 jcboLayoutOrientation.addActionListener(new ActionListener() {
62 @Override
63 public void actionPerformed(ActionEvent e) {
64 jlst.setLayoutOrientation(
65 jcboLayoutOrientation.getSelectedIndex());
66 }
67 });
68
69 jcboSelectionMode.addActionListener(new ActionListener() {
70 @Override
71 public void actionPerformed(ActionEvent e) {
72 jlst.setSelectionMode(
73 jcboSelectionMode.getSelectedIndex());
74 }
75 });
76
77 jlst.addListSelectionListener(new ListSelectionListener() {
78 @Override
79 public void valueChanged(ListSelectionEvent e) {

```

```

80 Object[] values = jlst.getSelectedValues();
81 String display = "";
82
83 for (int i = 0; i < values.length; i++) {
84 display += (String)values[i] + " ";
85 }
86
87 jlblStatus.setText(display);
88 }
89 });
90 }
91 }

```

A JList is created with six string values (lines 7-8). A JSpinner is created using a SpinnerNumberModel with initial value 8, minimum value -1, maximum value 20, and step 1 (lines 9-10). A JComboBox is created with string values VERTICAL (0), VERTICAL WRAP (1), and HORIZONTAL WRAP (2) for choosing layout orientation (lines 11-13). A JComboBox is created with string values SINGLE SELECTION (0), INTERVAL SELECTION (1), and MULTIPLE INTERVAL SELECTION (2) for choosing a selection mode (lines 14-17). A JLabel is created to display the selected elements in the list (lines 18).

A JList does not support scrolling. To create a scrollable list, create a JScrollPane and add an instance of JList to it (line 44).

The fixed list cell width and height are specified in lines 48-49. The default selection mode is multiple-interval selection. Line 50 sets the selection mode to single selection.

When a new visible row count is selected from the spinner, the setVisibleRowCount method is used to set the count (lines 53-58). When a new layout orientation is selected from the jcboLayoutOrientation combo box, the setLayoutOrientation method is used to set the layout orientation (lines 60-65). Note that the constant values for VERTICAL, VERTICAL WRAP, and HORIZONTAL WRAP are 0, 1, and 2, which correspond to the index values of these items in the combo box. When a new selection mode is selected from the jcboSelectionMode combo box, the setSelectionMode method is used to set the selection mode (lines 67-72). Note that the constant values for SINGLE SELECTION, SINGLE INTERVAL SELECTION, and MULTIPLE INTERVAL SELECTION are 0, 1, and 2, which correspond to the index value of these items in the combo box.

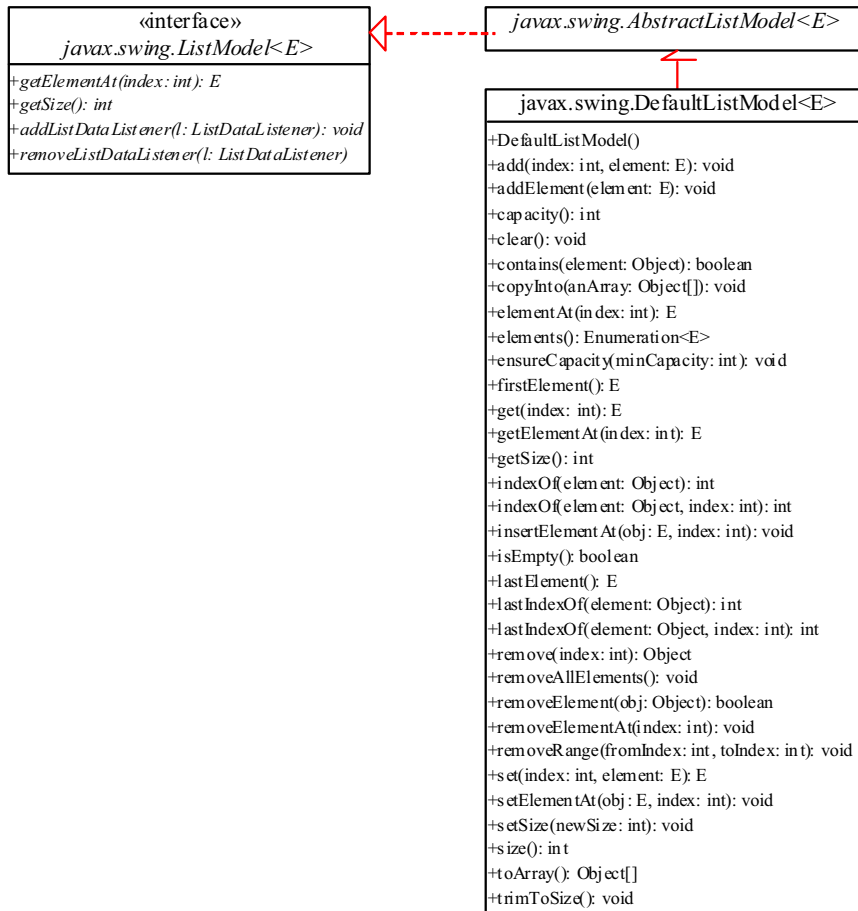
JList fires javax.swing.event.ListSelectionEvent to notify the listeners of the selections. The listener must implement the valueChanged handler to process the event. When the user selects an item in the list, the valueChanged handler is executed, which gets the selected items and displays all the items in the label (lines 74-85).

### 39.8 List Models

The preceding example constructs a list with a fixed set of strings. If you want to add new items to the list or delete

existing items, you have to use a list model. This section introduces list models.

The `JList` class delegates the responsibilities of storing and maintaining data to its data model. The `JList` class itself does not have methods for adding or removing items from the list. These methods are supported in `ListModel`, as shown in Figure 39.20.



**Figure 39.20**

*ListModel* stores and manages data in a list.

All list models implement the `ListModel` interface, which defines the registration methods for `ListDataEvent`. The instances of `ListDataListener` are notified when the items in the list are modified. `ListModel` also defines the methods `getSize` and `getElementAt`. The `getSize` method returns the length of the list, and the `getElementAt` method returns the element at the specified index.

AbstractListModel implements the ListModel and Serializable interfaces. AbstractListModel implements the registration methods in the ListModel, but does not implement the getSize and getElementAt methods.

DefaultListModel extends AbstractListModel and implements the two methods getSize and getElementAt, which are not implemented by AbstractListModel.

The methods in DefaultListModel are similar to those in the java.util.Vector class. You use the add method to insert an element to the list, the remove method to remove an element from the list, the clear method to clear the list, the getSize method to return the number of elements in the list, and the getElementAt method to retrieve an element. In fact, the DefaultListModel stores data in an instance of Vector, which is essentially a resizable array. Swing components were developed before the Java Collections Framework. In future implementations, Vector may be replaced by java.util.ArrayList.

NOTE

**<margin note: default list model>**

In most cases, if you create a Swing GUI object without specifying a model, an instance of the default model class is created. But this is not true for JList. By default, the model property in JList is not an instance of DefaultListModel. To use a list model, you should explicitly create one using DefaultListModel.

Listing 39.8 gives an example that creates a list using a list model and allows the user to add and delete items in the list, as shown in Figure 39.21. When the user clicks the *Add new item* button, an input dialog box is displayed to receive a new item.

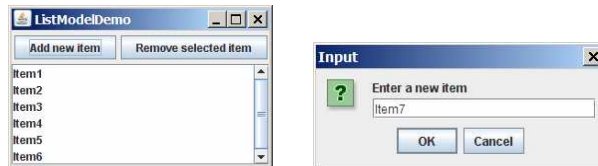


Figure 39.21

You can add elements and remove elements in a list using list models.

**Listing 39.8 ListModelDemo.java**

**<margin note line 6: list model>**  
**<margin note line 8: list>**  
**<margin note line 15: add items>**  
**<margin note line 30: button listener>**  
**<margin note line 44: button listener>**  
**<margin note line 51: main method omitted>**

```
1 import java.awt.*;
2 import java.awt.event.*;
3 import javax.swing.*;
```

```

4
5 public class ListModelDemo extends JApplet {
6 private DefaultListModel<String> listModel
7 = new DefaultListModel<String>();
8 private JList<String> jlst = new JList<String>(listModel);
9 private JButton jbtAdd = new JButton("Add new item");
10 private JButton jbtRemove = new JButton("Remove selected item");
11
12 /** Construct the applet */
13 public ListModelDemo() {
14 // Add items to the list model
15 listModel.addElement("Item1");
16 listModel.addElement("Item2");
17 listModel.addElement("Item3");
18 listModel.addElement("Item4");
19 listModel.addElement("Item5");
20 listModel.addElement("Item6");
21
22 JPanel panel = new JPanel();
23 panel.add(jbtAdd);
24 panel.add(jbtRemove);
25
26 add(panel, BorderLayout.NORTH);
27 add(new JScrollPane(jlst), BorderLayout.CENTER);
28
29 // Register listeners
30 jbtAdd.addActionListener(new ActionListener() {
31 @Override
32 public void actionPerformed(ActionEvent e) {
33 String newItem =
34 JOptionPane.showInputDialog("Enter a new item");
35
36 if (newItem != null)
37 if (jlst.getSelectedIndex() == -1)
38 listModel.addElement(newItem);
39 else
40 listModel.add(jlst.getSelectedIndex(), newItem);
41 }
42 });
43
44 jbtRemove.addActionListener(new ActionListener() {
45 @Override
46 public void actionPerformed(ActionEvent e) {
47 listModel.remove(jlst.getSelectedIndex());
48 }
49 });
50 }
51 }

```

The program creates `listModel` (line 6), which is an instance of `DefaultListModel`, and uses it to manipulate data in the list. The model enables you to add and remove items in the list.

A list is created from the list model (line 7). The initial elements are added into the model using the `addElement` method (lines 13-19).

To add an element, the user clicks the *Add new item* button to display an input dialog box. Type a new item in the dialog box.

The new item is inserted before the currently selected element in the list (line 38). If no element is selected, the new element is appended to the list (line 36).

To remove an element, the user has to select the element and then click the *Remove selected item* button. Note that only the first selected item is removed. You can modify the program to remove all the selected items (see Exercise 39.6).

What would happen if you clicked the *Remove selected item* button but no items were currently selected? This would cause an error. To fix it, see Exercise 39.6.

### 39.9 List Cell Renderer

The preceding example displays items as strings in a list. JList is very flexible and versatile, and it can be used to display images and GUI components in addition to simple text. This section introduces list cell renderers for displaying graphics.

In addition to delegating data storage and processing to list models, JList delegates the rendering of list cells to list cell renderers. All list cell renderers implement the ListCellRenderer interface, which defines a single method, getListCellRendererComponent, as follows:

```
public Component getListCellRendererComponent
(JList list, Object value, int index, boolean isSelected,
boolean cellHasFocus)
```

This method is passed with a list, the value associated with the cell, the index of the value, and information regarding whether the value is selected and whether the cell has the focus. The component returned from the method is painted on the cell in the list. By default, JList uses DefaultListCellRenderer to render its cells. The DefaultListCellRenderer class implements ListCellRenderer, extends JLabel, and can display either a string or an icon, but not both in the same cell.

For example, you can use JList's default cell renderer to display strings, as shown in Figure 39.22(a), using the following code:

```
JList list = new JList(new String[]{"Denmark", "Germany",
"China", "India", "Norway", "UK", "US"});
```



(a) Strings



(b) Icons



(c) Icons and strings

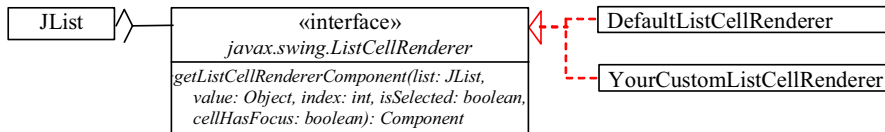
Figure 39.22

The cell renderer displays list items in a list.

You can use `JList`'s default cell renderer to display icons, as shown in Figure 39.22 (b), using the following code:

```
ImageIcon denmarkIcon = new ImageIcon(getClass().getResource(
 "image/denmarkIcon.gif"));
...
JList list = new JList(new ImageIcon[]{denmarkIcon, germanyIcon,
 chinaIcon, indiaIcon, norwayIcon, ukIcon, usIcon});
```

How do you display a string along with an icon in one cell, as shown in Figure 39.22 (c)? You need to create a custom renderer by implementing `ListCellRenderer`, as shown in Figure 39.23.



**Figure 39.23**

`ListCellRenderer` defines how cells are rendered in a list.

Suppose a list is created as follows:

```
JList list = new JList(new Object[][]{{denmarkIcon, "Denmark"},
 {germanyIcon, "Germany"}, {chinaIcon, "China"},
 {indiaIcon, "India"}, {norwayIcon, "Norway"}, {ukIcon, "UK"},
 {usIcon, "US"}});
```

Each item in the list is an array that consists of an icon and a string. You can create a custom cell renderer that retrieves an icon and a string from the list data model and display them in a label. The custom cell renderer class is given in Listing 39.9.

**Listing 39.9 MyListCellRenderer.java**

```
<margin note line 6: cell component>
<margin note line 18: set icon>
<margin note line 19: set text>
<margin note line 22: cell selected>
<margin note line 32: return rendering cell>

1 import java.awt.*;
2 import javax.swing.*;
3 import javax.swing.border.*;
4
5 public class MyListCellRenderer implements ListCellRenderer {
6 private JLabel jlblCell = new JLabel(" ", JLabel.LEFT);
7 private Border lineBorder =
8 BorderFactory.createLineBorder(Color.black, 1);
9 private Border emptyBorder =
10 BorderFactory.createEmptyBorder(2, 2, 2, 2);
11
12 /** Implement this method in ListCellRenderer */
13 public Component getListCellRendererComponent
14 (JList list, Object value, int index, boolean isSelected,
```



```

15 boolean cellHasFocus) {
16 Object[] pair = (Object[])value; // Cast value into an array
17 JLabelCell.setOpaque(true);
18 JLabelCell.setIcon((ImageIcon)pair[0]);
19 JLabelCell.setText(pair[1].toString());
20
21 if (isSelected) {
22 JLabelCell.setForeground(list.getSelectionForeground());
23 JLabelCell.setBackground(list.getSelectionBackground());
24 }
25 else {
26 JLabelCell.setForeground(list.getForeground());
27 JLabelCell.setBackground(list.getBackground());
28 }
29
30 JLabelCell.setBorder(cellHasFocus ? lineBorder : emptyBorder);
31
32 return JLabelCell;
33 }
34 }

```

The `MyListCellRenderer` class implements the `getListCellRendererComponent` method in the `ListCellRenderer` interface. This method is passed with the parameters `list`, `value`, `index`, `isSelected`, and `isFocused` (lines 13-15). The `value` represents the current item value. In this case, it is an array consisting of two elements. The first element is an image icon (line 18). The second element is a string (line 19). Both image icon and string are displayed on a label. The `getListCellRendererComponent` method returns the label (line 32), which is painted on the cell in the list.

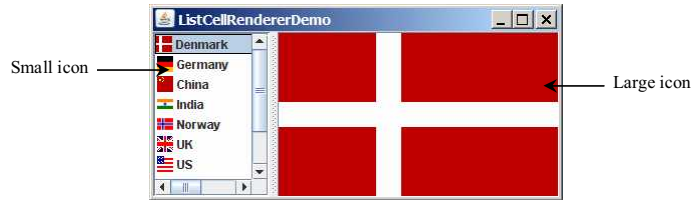
If the cell is selected, the background and foreground of the cell are set to the list's selection background and foreground (lines 22-23). If the cell is focused, the cell's border is set to the line border (line 30); otherwise, it is set to the empty border (line 30). The empty border serves as a divider between the cells.

NOTE

**<margin note: any GUI renderer>**

The example in Listing 39.9 uses a `JLabel` as a renderer. You may use any GUI component as a renderer, returned from the `getListCellRendererComponent` method.

Let us develop an example (Listing 39.10) that creates a list of countries and displays the flag image and name for each country as one item in the list, as shown in Figure 39.24. When a country is selected in the list, its flag is displayed in a label next to the list.



**Figure 39.24**

*The image and the text are displayed in the list cell.*

**Listing 39.10 ListCellRendererDemo.java**

```

<margin note line 7: nation strings>
<margin note line 9: small icons>
<margin note line 10: big icons>
<margin note line 13: list model>
<margin note line 16: list>
<margin note line 19: list cell renderer>
<margin note line 22: split pane>
<margin note line 25: image label>
<margin note line 31: load image icons>
<margin note line 33: add elements>
<margin note line 35: load image icons>
<margin note line 40: set renderer>
<margin note line 49: list listener>
<margin note line 55: main method omitted>

1 import javax.swing.*;
2 import javax.swing.event.*;
3 import java.awt.*;
4
5 public class ListCellRendererDemo extends JApplet {
6 private final static int NUMBER_OF_NATIONS = 7;
7 private String[] nations = new String[]
8 {"Denmark", "Germany", "China", "India", "Norway", "UK", "US"};
9 private ImageIcon[] icons = new ImageIcon[NUMBER_OF_NATIONS];
10 private ImageIcon[] bigIcons = new ImageIcon[NUMBER_OF_NATIONS];
11
12 // Create a list model
13 private DefaultListModel listModel = new DefaultListModel();
14
15 // Create a list using the list model
16 private JList jlstNations = new JList(listModel);
17
18 // Create a list cell renderer
19 private ListCellRenderer renderer = new MyListCellRenderer();
20
21 // Create a split pane
22 private JSplitPane jSplitPane = new JSplitPane();
23
24 // Create a label for displaying iamge
25 private JLabel jlblImage = new JLabel("", JLabel.CENTER);
26
27 /** Construct ListCellRenderer */
28 public ListCellRendererDemo() {
29 // Load small and large image icons
30 for (int i = 0; i < NUMBER_OF_NATIONS; i++) {
31 icons[i] = new ImageIcon(getClass().getResource(
32 "/image/flagIcon" + i + ".gif"));
33 listModel.addElement(new Object[]{icons[i], nations[i]});
34 }
35 }
36 }

```

```

35 bigIcons[i] = new ImageIcon(getClass().getResource(
36 "/image/flag" + i + ".gif"));
37 }
38
39 // Set list cell renderer
40 jlstNations.setCellRenderer(renderer);
41 jlstNations.setPreferredSize(new Dimension(200, 200));
42 jSplitPanel.setLeftComponent(new JScrollPane(jlstNations));
43 jSplitPanel.setRightComponent(jlblImage);
44 jlstNations.setSelectedIndex(0);
45 lblImage.setIcon(bigIcons[0]);
46 add(jSplitPanel, BorderLayout.CENTER);
47
48 // Register listener
49 jlstNations.addListSelectionListener(new ListSelectionListener() {
50 public void valueChanged(ListSelectionEvent e) {
51 lblImage.setIcon(bigIcons[jlstNations.getSelectedIndex()]);
52 }
53 });
54 }
55 }

```

Two types of icons are used in this program. The small icons are created from files `flagIcon0.gif`, ..., `flagIcon6.gif` (lines 31-32). These image files are the flags for Denmark, Germany, China, India, Norway, UK, and US. The small icons are rendered inside the list. The large icons for the same countries are created from files `flag0.gif`, ..., `flag6.gif` (lines 35-36). The large icons are displayed on a label on the right side of the split pane.

The `ListCellRendererDemo` class creates a list model (line 13) and adds the items to the model (line 33). Each item is an array of two elements (image icon and string). The list is created using the list model (line 16). The list cell renderer is created (line 19) and associated with the list (line 40).

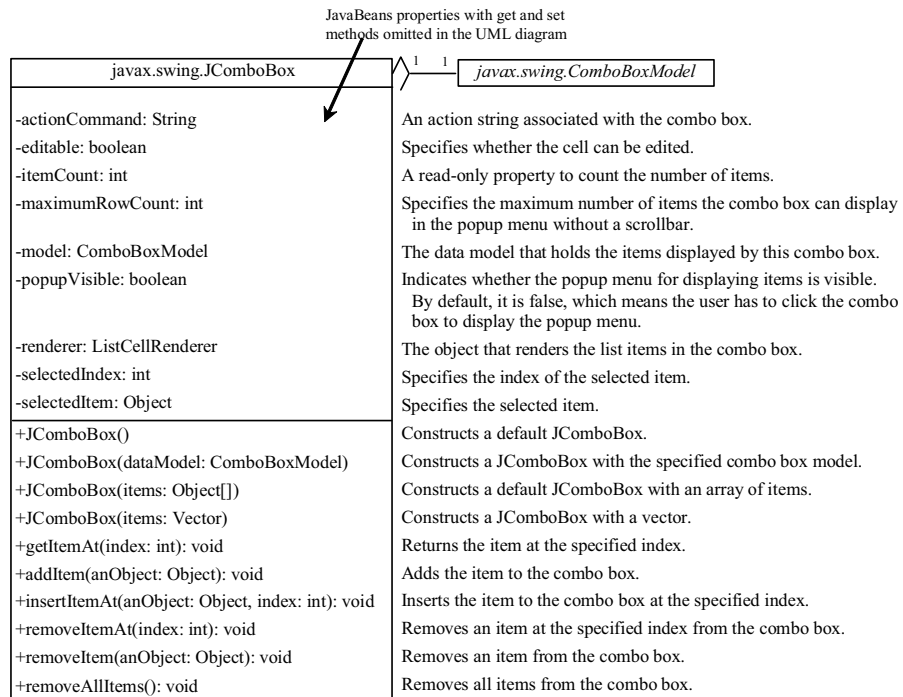
The `ListCellRendererDemo` class creates a split pane (line 22) and places the list on the left (line 42) and a label on the right (line 43).

When you choose a country in the list, the list-selection event handler is invoked (lines 49-53) to set a new image to the label in the right side of the split pane (line 51).

### 39.10 JComboBox and its Models

The basic features of `JComboBox` were introduced in §17.8, “Combo Boxes,” without using combo box models. This section introduces combo models and discusses the use of `JComboBox` in some detail.

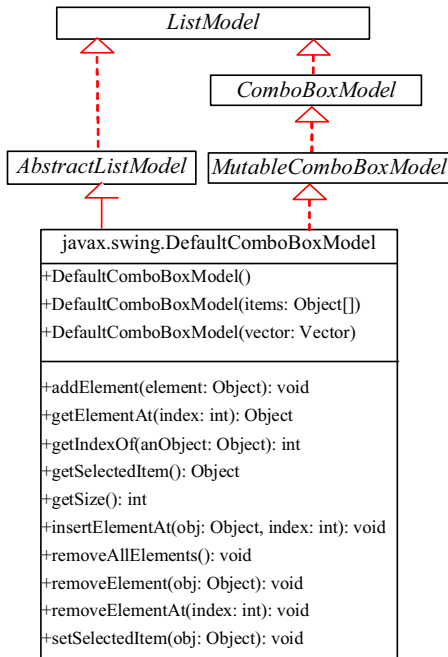
A combo box is similar to a list. Combo boxes and lists are both used for selecting items from a list. A combo box allows the user to select one item at a time, whereas a list permits multiple selections. When a combo box is selected, it displays a drop-down list contained in a popup menu. The selected item can be edited in the cell as if it were a text field. Figure 39.25 shows the properties and constructors of `JComboBox`. The data for a combo box are stored in `ComboBoxModel`. You can create a combo box from a combo box model, an array of objects, or a vector.



**Figure 39.25**

*JComboBox displays elements in a list.*

JComboBox delegates the responsibilities of storing and maintaining data to its data model. All combo box models implement the ComboBoxModel interface, which extends the ListModel interface and defines the getSelectedItem and setSelectedItem methods for retrieving and setting a selected item. The methods for adding and removing items are defined in the MutableComboBoxModel interface, which extends ComboBoxModel. When an instance of JComboBox is created without explicitly specifying a model, an instance of DefaultComboBoxModel is used. The DefaultComboBoxModel class extends AbstractListModel and implements MutableComboBoxModel, as shown in Figure 39.26.



**Figure 39.26**

ComboBoxModel stores and manages data in a combo box.

Usually you don't need to use combo box models explicitly, because `JComboBox` contains the methods for retrieving (`getItemAt`, `getSelectedItem`, and `getSelectedItemIndex`), adding (`addItem` and `insertItemAt`), and removing (`removeItem`, `removeItemAt`, and `removeAllItems`) items from the list.

`JComboBox` can fire `ActionEvent` and `ItemEvent`, among many other events. Whenever a new item is selected, `JComboBox` fires `ItemEvent` twice, once for deselecting the previously selected item, and the other for selecting the currently selected item. `JComboBox` fires an `ActionEvent` after generating an `ItemEvent`.

Combo boxes render cells exactly like lists, because the combo box items are displayed in a list contained in a popup menu. Therefore, a combo box cell renderer can be created exactly like a list cell renderer by implementing the `ListCellRenderer` interface. Like `JList`, `JComboBox` has a default cell renderer that displays a string or an icon, but not both at the same time. To display a combination of a string and an icon, you need to create a custom renderer. The custom list cell renderer `MyListCellRenderer` in Listing 39.9 can be used as a combo box cell renderer without any modification.

Listing 39.11 gives an example that creates a combo box to display the flag image and name for each country as one item in the list, as shown in Figure 39.27. When a country is selected in the list, its flag is displayed in a panel below the combo box.



Figure 39.27

The image and the text are displayed in the list cell of a combo box.

Listing 39.11 ComboBoxCellRendererDemo.java

```

<margin note line 7: nation strings>
<margin note line 9: small icons>
<margin note line 10: big icons>
<margin note line 13: combo box model>
<margin note line 16: combo box>
<margin note line 19: list cell renderer>
<margin note line 22: image label>
<margin note line 28: load image icons>
<margin note line 30: add elements>
<margin note line 32: load image icons>
<margin note line 37: set renderer>
<margin note line 43: action listener>
<margin note line 50: main method omitted>

1 import java.awt.*;
2 import java.awt.event.*;
3 import javax.swing.*;
4
5 public class ComboBoxCellRendererDemo extends JApplet {
6 private final static int NUMBER_OF_NATIONS = 7;
7 private String[] nations = new String[] {"Denmark",
8 "Germany", "China", "India", "Norway", "UK", "US"};
9 private ImageIcon[] icons = new ImageIcon[NUMBER_OF_NATIONS];
10 private ImageIcon[] bigIcons = new ImageIcon[NUMBER_OF_NATIONS];
11
12 // Create a combo box model
13 private DefaultComboBoxModel model = new DefaultComboBoxModel();
14
15 // Create a combo box with the specified model
16 private JComboBox jcboCountries = new JComboBox(model);
17
18 // Create a list cell renderer
19 private MyListCellRenderer renderer = new MyListCellRenderer();
20
21 // Create a label for displaying iamge
22 private JLabel jlblImage = new JLabel("", JLabel.CENTER);
23
24 /** Construct the applet */
25 public ComboBoxCellRendererDemo() {
26 // Load small and large image icons
27 for (int i = 0; i < NUMBER_OF_NATIONS; i++) {
28 icons[i] = new ImageIcon(getClass().getResource(
29 "/image/flagIcon" + i + ".gif"));
30 model.addElement(new Object[]{icons[i], nations[i]});
31
32 bigIcons[i] = new ImageIcon(getClass().getResource(
33 "/image/flag" + i + ".gif"));

```

```

34 }
35
36 // Set list cell renderer for the combo box
37 jcboCountries.setRenderer(renderer);
38 jlblImage.setIcon(bigIcons[0]);
39 add(jcboCountries, java.awt.BorderLayout.NORTH);
40 add(jlblImage, java.awt.BorderLayout.CENTER);
41
42 // Register listener
43 jcboCountries.addActionListener(new ActionListener() {
44 @Override
45 public void actionPerformed(java.awt.event.ActionEvent e) {
46 jlblImage.setIcon(bigIcons[jcboCountries.getSelectedIndex()]);
47 }
48 });
49 }
50 }

```

The program is very similar to the preceding example in Listing 39.10. Two types of image icons are loaded for each country and stored in the arrays `icons` and `bigIcons` (lines 27-34). Each item in the combo box is an array that consists of an icon and a string (line 30).

`MyListCellRenderer`, defined in Listing 39.9, is used to create a cell renderer in line 19. The cell renderer is plugged into the combo box in line 37.

When you choose a country from the combo box, the action event handler is invoked (lines 44-46). This handler sets a new image on the label (line 45).

### Key Terms

- **controller**
- **model**
- **MVC architecture**
- **view**

### Chapter Summary

1. The fundamental issue in the model-view approach is to ensure consistency between the views and the model. Any change in the model should be notified to the dependent views, and all the views should display the same data consistently. The model can be implemented as a source with appropriate event and event listener registration methods. The view can be implemented as a listener. Thus, if data are changed in the model, the view will be notified.
2. Every Swing user interface component (e.g., `JButton`, `JTextField`, `JList`, and `JComboBox`) has a property named `model` that refers to its data model. The data model is defined in an interface whose name ends with `Model` (e.g., `SpinnerModel`, `ListModel`, `ListSelectionModel`, and `ComboBoxModel`).
3. Most simple Swing components (e.g., `JButton`, `JTextField`, `JTextArea`) contain some properties of their models, and these

properties can be accessed and modified directly from the component without the existence of the model being known.

4. A JSpinner is displayed as a text field with a pair of tiny arrow buttons on its right side that enable the user to select numbers, dates, or values from an ordered sequence. A JSpinner's sequence value is defined by the SpinnerModel interface. AbstractSpinnerModel is a convenient abstract class that implements SpinnerModel and provides the implementation for its registration/deregistration methods. SpinnerListModel, SpinnerNumberModel, and SpinnerDateModel are concrete implementations of SpinnerModel. SpinnerNumberModel represents a sequence of numbers with properties maximum, minimum, and stepSize. SpinnerDateModel represents a sequence of dates. SpinnerListModel can store a list of any object values.
5. A JSpinner has a single child component, called the *editor*, which is responsible for displaying the current element or value of the model. Four editors are defined as static inner classes inside JSpinner: JSpinner.DefaultEditor, JSpinner.NumberEditor, JSpinner.DateEditor, and JSpinner.ListEditor.
6. JList has two supporting models: a list model and a list-selection model. The *list model* is for storing and processing data. The *list-selection model* is for selecting items. By default, items are rendered as strings or icons. You can also create a custom renderer implementing the ListCellRenderer interface.
7. JComboBox delegates the responsibilities of storing and maintaining data to its data model. All combo box models implement the ComboBoxModel interface, which extends the ListModel interface and defines the getSelectedItem and setSelectedItem methods for retrieving and setting a selected item. The methods for adding and removing items are defined in the MutableComboBoxModel interface, which extends ComboBoxModel. When an instance of JComboBox is created without explicitly specifying a model, an instance of DefaultComboBoxModel is used. The DefaultComboBoxModel class extends AbstractListModel and implements MutableComboBoxModel.
8. Combo boxes render cells exactly like lists, because the combo box items are displayed in a list contained in a popup menu. Therefore, a combo box cell renderer can be created exactly like a list cell renderer by implementing the ListCellRenderer interface.

## Test Questions

Do the test questions for this chapter online at [www.cs.armstrong.edu/liang/intro9e/test.html](http://www.cs.armstrong.edu/liang/intro9e/test.html).

## Review Questions

### Sections 39.2-39.3

39.1

What is model-view-controller architecture?



39.2

How do you do implement models, views, and controllers?

39.3

What are the variations of MVC architecture?

*Section 39.4*

39.4

Does each Swing GUI component (except containers such as JPanel) have a property named model? Is the type of model the same for all the components?

39.5

Does each model interface have a default implementation class? If so, does a Swing component use the default model class if no model is specified?

*Sections 39.5-39.6*

39.6

If you create a JSpinner without specifying a data model, what is the default model?

39.7

What is the internal data structure for storing data in SpinnerListModel? How do you convert an array to a list?

*Sections 39.7-39.9*

39.8

Does JList have a method, such as addItem, for adding an item to a list? How do you add items to a list? Can JList display icons and custom GUI objects in a list? Can a list item be edited? How do you initialize data in a list? How do you specify the maximum number of visible rows in a list without scrolling? How do you specify the height of a list cell? How do you specify the horizontal margin of list cells?

39.9 How do you create a list model? How do you add items to a list model? How do you remove items from a list model?

39.10 What are the three list-selection modes? Can you set the selection modes directly in an instance of JList? How do you obtain the selected item(s)?

39.11 How do you define a custom list cell renderer?

39.12 What is the handler for handling the ListSelectionEvent?

*Section 39.10*

39.13 Can multiple items be selected from a combo box? Can a combo box item be edited? How do you specify the maximum number of visible rows in a combo box without scrolling? Can you specify the height of a combo box cell using a method in JComboBox? How do you obtain the selected item in a combo box?

39.14 How do you add or remove items from a combo box?

39.15 Why is the cell renderer for a combo box the same as the renderer for a list?

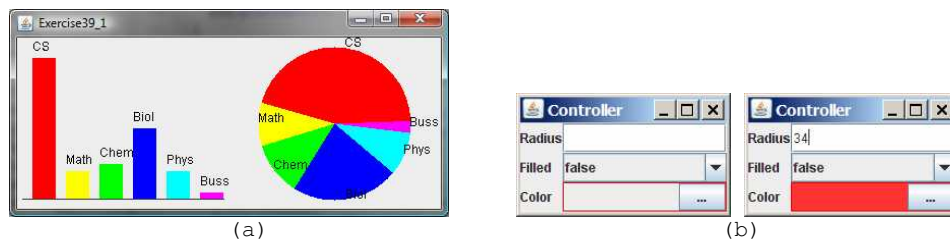
## Programming Exercises

### Section 39.2

#### 39.1\*\*\*

(Create MVC components) Create a model, named `ChartModel`, which holds data in an array of double elements named `data`, and the names for the data in an array of strings named `dataName`. For example, the enrollment data {200, 40, 50, 100, 40} stored in the array `data` are for {"CS", "Math", "Chem", "Biol", "Phys"} in the array `dataName`. These two properties have their respective get methods, but not individual set methods. Both properties are set together in the `setChartData(String[] newDataName, double[] newData)` method so that they can be displayed properly. Create a view named `PieChart` to present the data in a pie chart, and create a view named `BarChart` to present the data in a bar chart, as shown in Figure 39.28(a).

(Hint: Each pie represents a percentage of the total data. Color the pie using the colors from an array named `colors`, which is {`Color.red`, `Color.yellow`, `Color.green`, `Color.blue`, `Color.cyan`, `Color.magenta`, `Color.orange`, `Color.pink`, `Color.darkGray`}. Use `colors[i % colors.length]` for the *i*th pie. Use black color to display the data names.)



**Figure 39.28**

(a) The two views, `PieChart` and `BarChart`, receive data from the `ChartModel`; (b) Clicking the eclipse button displays the color chooser dialog box for specifying a color.

#### 39.2\*

(Revise Listing 39.3 `CircleController.java`) `CircleController` uses a text field to obtain a new radius and a combo box to obtain a Boolean value to specify whether the circle is filled. Add a new row in `CircleController` to let the user choose color using the `JColorChooser` component, as shown in Figure 39.28(b). The new row consists of a label with text `Color`, a label to display color, and an eclipse button. The user can click the eclipse button to display a `JColorChooser` dialog box. Once the user selects a color, the color is displayed as the background for the label on the left of the eclipse button.

### Sections 39.5-39.6

#### 39.3\*\*

(Synchronize spinners) The date spinner is synchronized with the day, month, and year spinners in Listing 39.6,

SpinnerModelEditorDemo.java. Improve it to synchronize the day, month, and year spinners with the date spinner. In other words, when a new value is selected in the date spinner, the values in the day, month, and year spinners are updated accordingly.

#### 39.4\*

(*Custom spinner model*) Develop a custom spinner model that represents a sequence of numbers of power 2—that is, 1, 2, 4, 8, 16, 32, and so on. Your model should implement `AbstractSpinnerModel`. The registration/deregistration methods for `ChangeListener` have already been implemented in `AbstractSpinnerModel`. You need to implement `getNextValue()`, `getPreviousValue()`, `getValue()`, and `setValue(Object)` methods.

#### 39.5\*

(*Reverse the numbers displayed in a spinner*) The numbers displayed in a spinner increase when the up-arrow button is clicked and decrease when the down-arrow button is clicked. You can reverse the sequence by creating a new model that extends `SpinnerNumberModel` and overrides the `getNextValue` and `getPreviousValue` methods. Write a test program that uses the new model, as shown in Figure 39.29.



**Figure 39.29**

*The numbers in the spinner are in decreasing order.*

### Sections 39.7-39.9

#### 39.6\*

(*Remove selected items in a list*) Modify Listing 39.8, `ListModelDemo.java`, to meet the following requirements:

- Remove all the selected items from the list when the *Remove selected item* button is clicked.
- Enable the items to be deleted using the DELETE key.

#### 39.7\*

(*Custom list cell renderer*) Listing 39.10, `ListCellRendererDemo.java`, has two types of images for each country. The small images are used for display in the list, and the large ones are used for display outside the list. Assume that only the large images are available. Rewrite the custom cell renderer to use a `JPanel` instead of a `JLabel` for rendering a cell. Each cell consists of an image and a string. Display the image in an `ImageViewer` and the string in a label. The `ImageViewer` component was introduced in Listing 13.15, `ImageViewer.java`. The image can be stretched

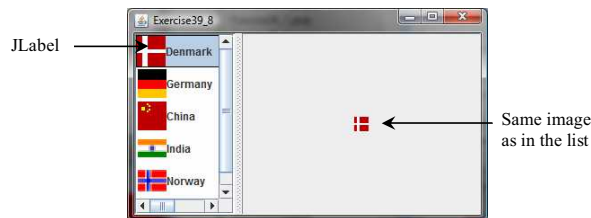
in an `ImageViewer`. Set the dimension of an image viewer to 32 by 32, as shown in Figure 39.30. Revise Listing 39.10 to test the new custom cell renderer.



**Figure 39.30**  
*ImageViewer* is used to render the image in the list.

39.8\*

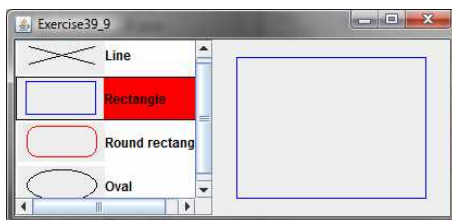
(Delete selected items in a list using the DELETE key) Modify Listing 39.10, `ListCellRendererDemo.java`, to delete selected items from the list using the DELETE key. After some items are deleted from the list, the index of a selected item in the list does not match the index of the item in the `bigIcons` array. As a result, you cannot use the image icon in the `bigIcons` array to display the image to the right side of the split pane. Revise the program to retrieve the icon from the selected item in the list and display it, as shown in Figure 39.31.



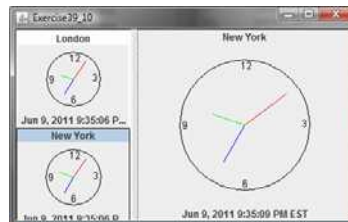
**Figure 39.31**  
Images in the list are also used for display in the label placed in the right side of a split pane.

39.9\*\*

(Render figures) Create a program that shows a list of geometrical shapes along with a label in an instance of `JList`, as shown in Figure 39.32(a). Display the selected figure in a panel when selecting a figure from the list. The figures can be drawn using the `FigurePanel` class in Listing 14.5, `FigurePanel.java`.



(a)



(b)

**Figure 39.32**

(a) The list displays geometrical shapes and their names; (b) The list displays cities and clocks.

39.10\*\*

(List of clocks) Write a program that displays a list of cities and their local times in a clock, as shown in Figure 39.32(b). When a city is selected in the list, its clock is displayed in a large picture on the right.

### Section 39.10

39.11\*\*

(Create custom cell renderer in a combo box) Create a program that shows a list of geometrical shapes along with a label in a combo box, as shown in Figure 39.33(a). This exercise may share the list cell renderer with Exercise 39.9.

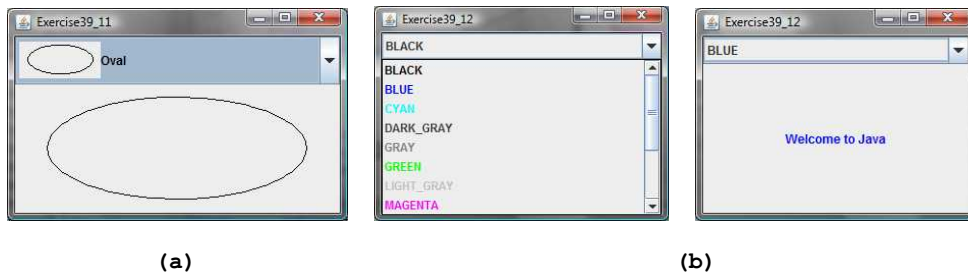


Figure 39.33

(a) The combo box contains a list of geometrical shapes and the shape names. (b) The combo box contains a list of color names, each using its own color for its foreground.

39.12\*\*

(Render colored text) Write a program that enables the user to choose the foreground colors for a label, as shown in Figure 39.33(b). The combo box contains 13 standard colors (BLACK, BLUE, CYAN, DARK\_GRAY, GRAY, GREEN, LIGHT\_GRAY, MAGENTA, ORANGE, PINK, RED, WHITE, YELLOW). Each color name in the combo box uses its own color for its foreground.

39.13\*

(Delete a selected item in a combo box using the DELETE key) Modify Listing 39.11, `ComboBoxCellRendererDemo.java`, to delete the selected item from the combo box using the DELETE key.

### Comprehensive

39.14\*

(Calendar) Write a program that controls a calendar using a spinner, as shown in Figure 39.7. Use the `CalendarPanel` class (see Listing 31.4) to display the calendar.

*\*\*\*This is a bonus Web chapter*

## CHAPTER 40

### JTable and JTree

#### Objectives

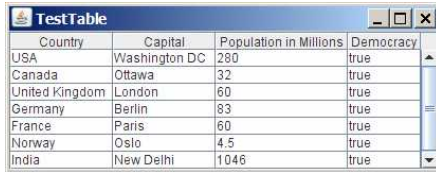
- To display tables using JTable (§40.2).
- To process rows and columns using TableModel, DefaultTableModel, TableColumnModel, DefaultTableColumnModel, and ListSelectionModel (§§40.3-40.5).
- To enable auto sort and filtering on table model (§40.4).
- To add rows and columns, delete rows and columns in a table (§40.5).
- To render and edit table cells using the default renderers and editors (§40.6).
- To render and edit table cells using the custom renderers and editors (§40.7).
- To handle table model events (§40.8).
- To display data in a tree hierarchy using JTree (§40.9).
- To model the structure of a tree using using TreeModel and DefaultTreeModel (§40.10).
- To add, remove, and process tree nodes using TreeNode, MutableTreeNode, and DefaultMutableTreeNode (§40.11).
- To select tree nodes and paths using TreeSelectionModel and DefaultTreeSelectionModel (§40.12).
- To render and edit tree nodes using the default and custom renderers and editors (§40.14).

## 40.1 Introduction

The preceding chapter introduced the model-view architecture, Swing MVC, and the models in `JSpinner`, `JList`, and `JComboBox`. This chapter introduces `JTable` and `JTree`, and how to use the models to process data in `JTable` and `JTree`.

## 40.2 `JTable`

`JTable` is a Swing component that displays data in rows and columns in a two-dimensional grid, as shown in Figure 40.1.



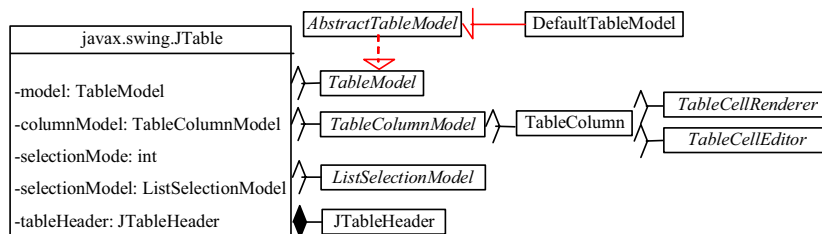
Country	Capital	Population in Millions	Democracy
USA	Washington DC	280	true
Canada	Ottawa	32	true
United Kingdom	London	60	true
Germany	Berlin	83	true
France	Paris	60	true
Norway	Oslo	4.5	true
India	New Delhi	1046	true

**Figure 40.1**

`JTable` displays data in a table.

`JTable` doesn't directly support scrolling. To create a scrollable table, you need to create a `JScrollPane` and add an instance of `JTable` to the scroll pane. If a table is not placed in a scroll pane, its column header will not be visible, because the column header is placed in the header of the view port of a scroll pane.

`JTable` has three supporting models: a table model, a column model, and a list-selection model. The *table model* is for storing and processing data. The *column model* represents all the columns in the table. The *list-selection model* is the same as the one used by `JList` for selecting rows, columns, and cells in a table. `JTable` also has two useful supporting classes, `TableColumn` and `JTableHeader`. `TableColumn` contains the information on a particular column. `JTableHeader` can be used to display table header. Each column has a default editor and renderer. You can also create a custom editor by implementing the `TableCellEditor` interface, and create a custom renderer by implementing the `TableCellRenderer` interface. The relationship of these interfaces and classes is shown in Figure 40.2.



**Figure 40.2**

`JTable` contains many supporting interfaces and classes.

NOTE: All the supporting interfaces and classes for `JTable` are grouped in the `javax.swing.table` package.

Figure 40.3 shows the constructors, properties, and methods of `JTable`.

javax.swing.JTable	
-autoCreateColumnsFromModel: boolean	Indicates whether the columns are created in the table (default: true).
-autoResizeMode: int	Specifies how columns are resized (default: SUBSEQUENT_COLUMNS).
-cellEditor: TableCellEditor	Specifies a cell editor.
-columnModel: TableColumnModel	Maintains the table column data.
-columnSelectionAllowed: boolean	Specifies whether the columns can be selected (default: false).
-editingColumn: int	Specifies the column of the cell that is currently being edited.
-editingRow: int	Specifies the row of the cell that is currently being edited.
-gridColor: java.awt.Color	The color used to draw grid lines (default: GRAY).
-intercellSpacing: Dimension	Specifies horizontal and vertical margins between cells (default: 1, 1).
-model: TableModel	Maintains the table model.
-rowCount: int	Read-only property that counts the number of rows in the table.
-rowHeight: int	Specifies the row height of the table (default: 16 pixels).
-rowMargin: int	Specifies the vertical margin between rows (default: 1 pixel).
-rowSelectionAllowed: boolean	Specifies whether the rows can be selected (default: true).
-selectionBackground: java.awt.Color	The background color of selected cells.
-selectionForeground: java.awt.Color	The foreground color of selected cells.
-showGrid: boolean	Specify whether the grid lines are displayed (write-only, default: true).
-selectionMode: int	Specifies a selection mode (write-only).
-selectionModel: ListSelectionModel	Specifies a selection model.
-showHorizontalAllLines: boolean	Specifies whether the horizontal grid lines are displayed (default: true).
-showVerticalAllLines: boolean	Specifies whether the vertical grid lines are displayed (default: true).
-tableHeader: JTableHeader	Specifies a table header.
+JTable()	Creates a default JTable with all the default models.
+JTable(numRows: int, numColumns: int)	Creates a JTable with the specified number of empty rows and columns.
+JTable(rowData: Object[][], columnData: Object[])	Creates a JTable with the specified row data and column header names.
+JTable(dm: TableModel)	Creates a JTable with the specified table model.
+JTable(dm: TableModel, cm: TableColumnModel)	Creates a JTable with the specified table model and table column model.
+JTable(dm: TableModel, cm: TableColumnModel, sm: ListSelectionModel)	Creates a JTable with the specified table model, table column model, and selection model.
+JTable(rowData: Vector, columnNames: Vector)	Creates a JTable with the specified row data and column data in vectors.
+addColumn(aColumn: TableColumn): void	Adds a new column to the table.
+clearSelection(): void	Deselects all selected columns and rows.
+editCellAt(row: int, column: int): void	Edits the cell if it is editable.
+getDefaultEditor(column: Class): TableCellEditor	Returns the default editor for the column.
+getDefaultRenderer(col: Class): TableCellRenderer	Returns the default renderer for the column.
+setDefaultEditor(column: Class, editor: TableCellEditor): void	Sets the default editor for the column.
+setDefaultRenderer(column: Class, editor: TableCellRenderer): void	Sets the default renderer for the column.

JavaBeans properties with get and set methods omitted in the UML diagram

**Figure 40.3**

*The `JTable` class is for creating, customizing, and manipulating tables.*

The `JTable` class contains seven constructors for creating tables. You can create a table using its no-arg constructor, its models, row data in a two-dimensional array, and column header names in



an array, or row data and column header names in vectors. Listing 40.1 creates a table with the row data and column names (line 20) and places it in a scroll pane (line 23). The table is displayed in Figure 40.1.

Listing 40.1 TestTable.java

```
<margin note line 5: column names>
<margin note line 9: row data>
<margin note line 20: create table>
<margin note line 23: scroll pane>
<margin note line 25: main method omitted>

1 import javax.swing.*;
2
3 public class TestTable extends JApplet {
4 // Create table column names
5 private String[] columnNames =
6 {"Country", "Capital", "Population in Millions", "Democracy"};
7
8 // Create table data
9 private Object[][] data = {
10 {"USA", "Washington DC", 280, true},
11 {"Canada", "Ottawa", 32, true},
12 {"United Kingdom", "London", 60, true},
13 {"Germany", "Berlin", 83, true},
14 {"France", "Paris", 60, true},
15 {"Norway", "Oslo", 4.5, true},
16 {"India", "New Delhi", 1046, true}
17 };
18
19 // Create a table
20 private JTable jTable1 = new JTable(data, columnNames);
21
22 public TestTable() {
23 add(new JScrollPane(jTable1));
24 }
25 }
```

NOTE

<margin note: autoboxing>

Primitive type values such as `280` and `true` in line 10 are autoboxed into `new Integer(280)` and `new Boolean(true)`.

`JTable` is a powerful control with a variety of properties that provide many ways to customize tables. All the frequently used properties are documented in Figure 40.3. The `autoResizeMode` property specifies how columns are resized (you can resize table columns but not rows). Possible values are:

```
JTable.AUTO_RESIZE_OFF
JTable.AUTO_RESIZE_LAST_COLUMN
JTable.AUTO_RESIZE_SUBSEQUENT_COLUMNS
JTable.AUTO_RESIZE_NEXT_COLUMN
JTable.AUTO_RESIZE_ALL_COLUMNS
```

The default mode is `JTable.AUTO_RESIZE_SUBSEQUENT_COLUMNS`. Initially, each column in the table occupies the same width (75 pixels). With `AUTO_RESIZE_OFF`, resizing a column does not affect the widths of the other columns. With `AUTO_RESIZE_LAST_COLUMN`,

resizing a column affects the width of the last column. With `AUTO_RESIZE_SUBSEQUENT_COLUMNS`, resizing a column affects the widths of all the subsequent columns. With `AUTO_RESIZE_NEXT_COLUMN`, resizing a column affects the widths of the next columns. With `AUTO_RESIZE_ALL_COLUMNS`, resizing a column affects the widths of all the columns.

Listing 40.2 gives an example that demonstrates the use of several `JTable` properties. The example creates a table and allows the user to choose an Auto Resize Mode, specify the row height and margin, and indicate whether the grid is shown. A sample run of the program is shown in Figure 40.4.

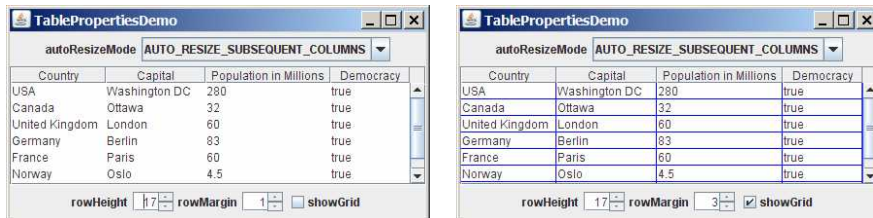


Figure 40.4

You can specify an autoresizing mode, the table's row height and row margin, and whether to show the grid in the table.

Listing 40.2 TablePropertiesDemo.java

```

<margin note line 9: column names>
<margin note line 13: table data>
<margin note line 23: table>
<margin note line 27: spinners>
<margin note line 35: combo box>
<margin note line 40: create UI>
<margin note line 57: table properties>
<margin note line 64: spinner listener>
<margin note line 72: spinner listener>
<margin note line 80: check-box listener>
<margin note line 88: combo box listener>
<margin note line 109: main method omitted>

1 import java.awt.*;
2 import java.awt.event.*;
3 import javax.swing.*;
4 import javax.swing.event.*;
5
6 public class TablePropertiesDemo extends JApplet {
7 // Create table column names
8 private String[] columnNames =
9 {"Country", "Capital", "Population in Millions", "Democracy"};
10
11 // Create table data
12 private Object[][] rowData = {
13 {"USA", "Washington DC", 280, true},
14 {"Canada", "Ottawa", 32, true},
15 {"United Kingdom", "London", 60, true},
16 {"Germany", "Berlin", 83, true},
17 {"France", "Paris", 60, true},
18 {"Norway", "Oslo", 4.5, true},
19 {"India", "New Delhi", 1046, true}

```

```

20 };
21
22 // Create a table
23 private JTable jTable1 = new JTable(rowData, columnNames);
24
25 // Create two spinners
26 private JSpinner jspiRowHeight =
27 new JSpinner(new SpinnerNumberModel(16, 1, 50, 1));
28 private JSpinner jspiRowMargin =
29 new JSpinner(new SpinnerNumberModel(1, 1, 50, 1));
30
31 // Create a checkbox
32 private JCheckBox jchkShowGrid = new JCheckBox("showGrid", true);
33
34 // Create a combo box
35 private JComboBox jcboAutoResizeMode = new JComboBox(new String[]{
36 "AUTO_RESIZE_OFF", "AUTO_RESIZE_LAST_COLUMN",
37 "AUTO_RESIZE_SUBSEQUENT_COLUMNS", "AUTO_RESIZE_NEXT_COLUMN",
38 "AUTO_RESIZE_ALL_COLUMNS"});
39
40 public TablePropertiesDemo() {
41 JPanel panell = new JPanel();
42 panell.add(new JLabel("rowHeight"));
43 panell.add(jspiRowHeight);
44 panell.add(new JLabel("rowMargin"));
45 panell.add(jspiRowMargin);
46 panell.add(jchkShowGrid);
47
48 JPanel panel2 = new JPanel();
49 panel2.add(new JLabel("autoResizeMode"));
50 panel2.add(jcboAutoResizeMode);
51
52 add(panell, BorderLayout.SOUTH);
53 add(panel2, BorderLayout.NORTH);
54 add(new JScrollPane(jTable1));
55
56 // Initialize jTable1
57 jTable1.setAutoResizeMode(JTable.AUTO_RESIZE_OFF);
58 jTable1.setGridColor(Color.BLUE);
59 jTable1.setSelectionMode(ListSelectionModel.SINGLE_SELECTION);
60 jTable1.setSelectionBackground(Color.RED);
61 jTable1.setSelectionForeground(Color.WHITE);
62
63 // Register and create a listener for jspiRowHeight
64 jspiRowHeight.addChangeListener(new ChangeListener() {
65 public void stateChanged(ChangeEvent e) {
66 jTable1.setRowHeight(
67 ((Integer) (jspiRowHeight.getValue())).intValue());
68 }
69 });
70
71 // Register and create a listener for jspiRowMargin
72 jspiRowMargin.addChangeListener(new ChangeListener() {
73 public void stateChanged(ChangeEvent e) {
74 jTable1.setRowMargin(
75 ((Integer) (jspiRowMargin.getValue())).intValue());
76 }
77 });
78
79 // Register and create a listener for jchkShowGrid
80 jchkShowGrid.addActionListener(new ActionListener() {
81 @Override
82 public void actionPerformed(ActionEvent e) {
83 jTable1.setShowGrid(jchkShowGrid.isSelected());
84 }
85 });

```

```

86
87 // Register and create a listener for jchoAutoResizeMode
88 jchoAutoResizeMode.addActionListener(new ActionListener() {
89 @Override
90 public void actionPerformed(ActionEvent e) {
91 String selectedItem =
92 (String)jchoAutoResizeMode.getSelectedItem();
93
94 if (selectedItem.equals("AUTO_RESIZE_OFF"))
95 jTable1.setAutoResizeMode(JTable.AUTO_RESIZE_OFF);
96 else if (selectedItem.equals("AUTO_RESIZE_LAST_COLUMN"))
97 jTable1.setAutoResizeMode(JTable.AUTO_RESIZE_LAST_COLUMN);
98 else if (selectedItem.equals
99 ("AUTO_RESIZE_SUBSEQUENT_COLUMNS"))
100 jTable1.setAutoResizeMode(
101 JTable.AUTO_RESIZE_SUBSEQUENT_COLUMNS);
102 else if (selectedItem.equals("AUTO_RESIZE_NEXT_COLUMN"))
103 jTable1.setAutoResizeMode(JTable.AUTO_RESIZE_NEXT_COLUMN);
104 else if (selectedItem.equals("AUTO_RESIZE_ALL_COLUMNS"))
105 jTable1.setAutoResizeMode(JTable.AUTO_RESIZE_ALL_COLUMNS);
106 }
107 });
108 }
109 }

```

If you know the row data in advance, creating a table using the constructor `JTable(Object[][] rowData, Object[] columnNames)` is convenient. As shown in line 23, a `JTable` is created using this constructor.

Two `JSpinner` objects (`jspiRowHeight`, `jspiRowMargin`) for selecting row height and row margin are created in lines 26-29. The initial value for `jspiRowHeight` is set to `16`, which is the default property value for `rowHeight`. The initial value for `jspiRowMargin` is set to `1`, which is the default property value for `rowMargin`. A check box (`jchkShowGrid`) is created with label `showGrid` and initially selected in line 32. A combo box for selecting `autoResizeMode` is created in lines 35-38.

The values of the `JTable` properties (`autoResizeMode`, `gridColor`, `selectionMode`, `selectionBackground`, and `selectionForeground`) are set in lines 57-61.

The code for processing spinners, check boxes, and combo boxes is given in lines 64-106.

### 40.3 Table Models and Table Column Models

#### <margin note: [TableModel](#)>

`JTable` delegates data storing and processing to its table data model. A table data model must implement the `TableModel` interface, which defines the methods for registering table model listeners, manipulating cells, and obtaining row count, column count, column class, and column name.

#### <margin note: [AbstractTableModel](#)>

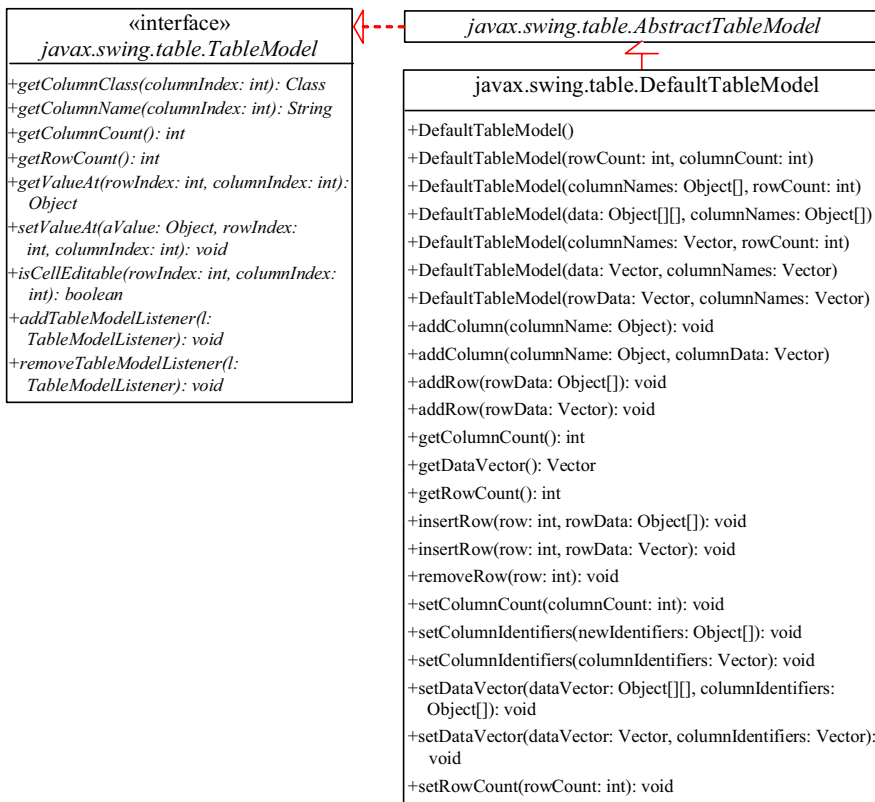
The `AbstractTableModel` class provides partial implementations for most of the methods in `TableModel`. It takes care of the management of listeners and provides some conveniences for generating `TableModelEvents` and dispatching them to the listeners. To create a concrete `TableModel`, you simply extend

AbstractTableModel and implement at least the following three methods:

- `public int getRowCount()`
- `public int getColumnCount()`
- `public Object getValueAt(int row, int column)`

**<margin note: DefaultTableModel>**

The DefaultTableModel class extends AbstractTableModel and implements these three methods. Additionally, DefaultTableModel provides concrete storage for data. The data are stored in a vector. The elements in the vector are arrays of objects, each of which represents an individual cell value. The methods in DefaultTableModel for accessing and modifying data are shown in Figure 40.5.



**Figure 40.5**

TableModel stores and manages data in a table and DefaultTableModel provides a default implementation for TableModel.

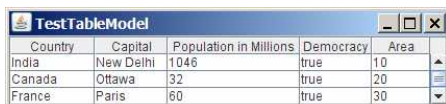
Listing 40.3 gives an example that demonstrates table models. The example creates a table model (line 16), plugs the model to the table (line 20), appends a row to the table (line 25), inserts a row before the first row (line 26), removes a row with index 1 (line 28), adds a new column (line 29), and sets new values at

specified cells (lines 30-32). Figure 40.6 shows the output of the program.

Listing 40.3 TestTableModel.java

```
<margin note line 6: column names>
<margin note line 10: row data>
<margin note line 16: create table model>
<margin note line 20: create table>
<margin note line 23: scroll pane>
<margin note line 25: add row>
<margin note line 26: insert row>
<margin note line 28: remove row>
<margin note line 29: add column>
<margin note line 30: set value>
<margin note line 34: main method omitted>

1 import javax.swing.*;
2 import javax.swing.table.*;
3
4 public class TestTableModel extends JApplet {
5 // Create table column names
6 private String[] columnNames =
7 {"Country", "Capital", "Population in Millions", "Democracy"};
8
9 // Create table data
10 private Object[][] data = {
11 {"USA", "Washington DC", 280, true},
12 {"Canada", "Ottawa", 32, true}
13 };
14
15 // Create a model
16 private DefaultTableModel tableModel =
17 new DefaultTableModel(data, columnNames);
18
19 // Create a table
20 private JTable jTable1 = new JTable(tableModel);
21
22 public TestTableModel() {
23 add(new JScrollPane(jTable1));
24
25 tableModel.addRow(new Object[]{"France", "Paris", 60, true});
26 tableModel.insertRow(0, new Object[]
27 {"India", "New Delhi", 1046, true});
28 tableModel.removeRow(1);
29 tableModel.addColumn("Area");
30 tableModel.setValueAt(10, 0, 4);
31 tableModel.setValueAt(20, 1, 4);
32 tableModel.setValueAt(30, 2, 4);
33 }
34 }
```



Country	Capital	Population in Millions	Democracy	Area
India	New Delhi	1046	true	10
Canada	Ottawa	32	true	20
France	Paris	60	true	30

Figure 40.6

TableModel and DefaultTableModel contain the methods for adding, updating, and removing table data.

TableModel manages table data. You can add and remove rows through a TableModel. You can also add a column through a TableModel. However, you cannot remove a column through a TableModel. To remove a column from a JTable, you have to use a table column model.

<margin note: TableColumnModel>

Table column models manage columns in a table. They can be used to select, add, move, and remove table columns. A table column model must implement the TableColumnModel interface, which defines the methods for registering table column model listeners, and for accessing and manipulating columns, as shown in Figure 40.7.

<margin note: DefaultTableColumnModel>

DefaultTableColumnModel is a concrete class that implements TableColumnModel and PropertyChangeListener. The DefaultTableColumnModel class stores its columns in a vector and contains an instance of ListSelectionModel for selecting columns.

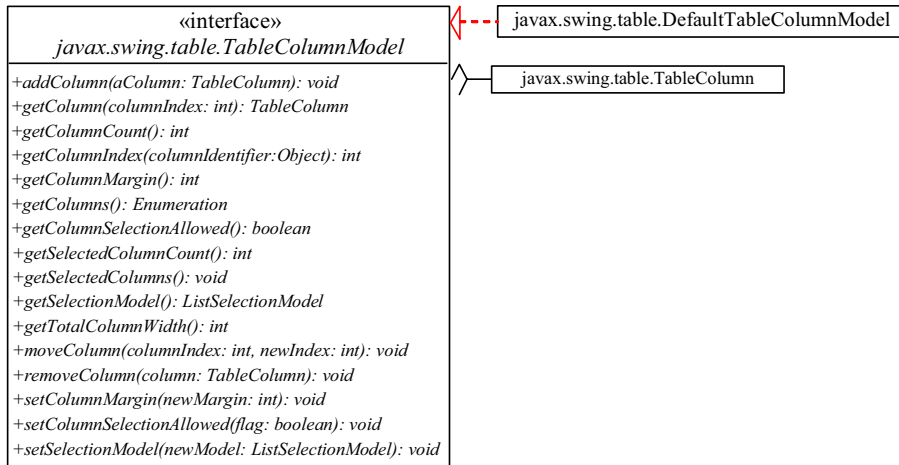


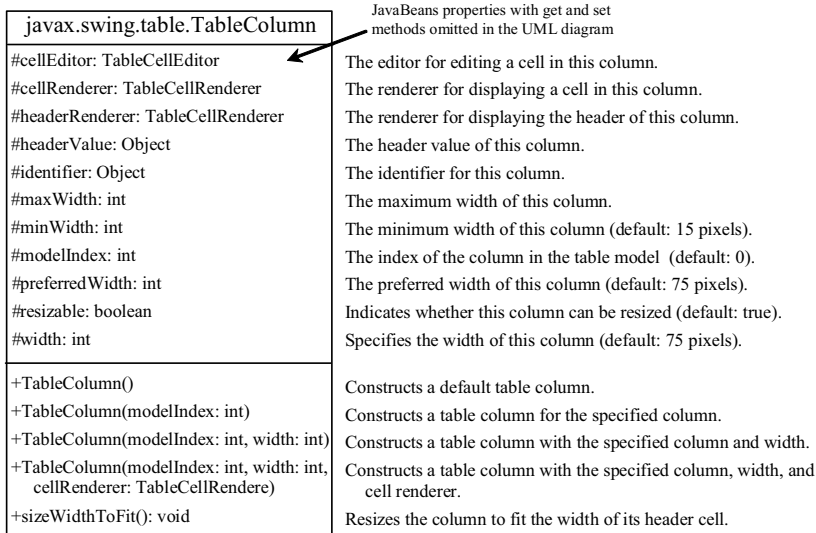
Figure 40.7

TableColumnModel manages columns in a table and DefaultTableColumnModel is a concrete implementation of it.

<margin note: TableColumn>

The column model deals with all the columns in a table. The TableColumn class is used to model an individual column in the table. An instance of TableColumn for a specified column can be obtained using the `getColumn(index)` method in TableColumnModel or the `getColumn(columnIdentifier)` method in JTable.

Figure 40.8 shows the properties, constructors, and methods in `TableColumn` for manipulating column width and specifying the cell renderer, cell editor, and header renderer.



**Figure 40.8**

The `TableColumn` class models a single column.

Listing 40.4 gives an example that demonstrates table column models. The example obtains the table column model from the table (line 21), moves the first column to the second (line 22), and removes the last column (lines 23). Figure 40.9 shows the output of the program

**Listing 40.4 TestTableColumnModel.java**

```

<margin note line 6: column names>
<margin note line 10: row data>
<margin note line 16: create table>
<margin note line 19: scroll pane>
<margin note line 21: column model>
<margin note line 22: move a column>
<margin note line 23: remove a column>
<margin note line 25: main method omitted>

1 import javax.swing.*;
2 import javax.swing.table.*;
3
4 public class TestTableColumnModel extends JApplet {
5 // Create table column names
6 private String[] columnNames =
7 {"Country", "Capital", "Population in Millions", "Democracy"};
8
9 // Create table data
10 private Object[][] data = {
11 {"USA", "Washington DC", 280, true},
12 {"Canada", "Ottawa", 32, true}
13 };

```



```

14
15 // Create a table
16 private JTable jTable1 = new JTable(data, columnNames);
17
18 public TestTableColumnModel() {
19 add(new JScrollPane(jTable1));
20
21 TableColumnModel columnModel = jTable1.getColumnModel();
22 columnModel.moveColumn(0, 1);
23 columnModel.removeColumn(columnModel.getColumn(3));
24 }
25 }

```



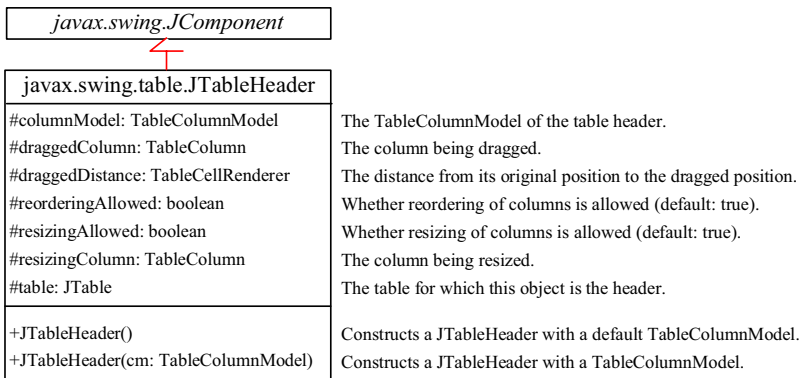
**Figure 40.9**

*The `TableColumnModel` contains the methods for moving and removing columns.*

NOTE: Some of the methods defined in the table model and the table column model are also defined in the `JTable` class for convenience. For instance, the `getColumnCount()` method is defined in `JTable`, `TableModel`, and `TableColumnModel`, the `addColumn` method defined in the column model is also defined in the table model, and the `getColumn()` method defined in the column model is also defined in the `JTable` class.

**<margin note: `TableHeader`>**

`JTableHeader` is a GUI component that displays the header of the `JTable` (see Figure 40.10). When you create a `JTable`, an instance of `JTableHeader` is automatically created and stored in the `tableHeader` property. By default, you can reorder the columns by dragging the header of the column. To disable it, set the `reorderingAllowed` property to `false`.



**Figure 40.10**

*The `JTableHeader` class displays the header of the `JTable`.*

## 40.4 Auto Sort and Filtering

Auto sort and filtering are two useful features. To enable auto sort on any column in a `JTable`, create an instance of `TableRowSorter` with a table model and set `JTable`'s `rowSorter` as follows:

**<margin note: create a `TableRowSorter`>**

```
TableRowSorter<TableModel> sorter =
 new TableRowSorter<TableModel>(tableModel);
```

**<margin note: set `rowSorter`>**

```
jTable.setRowSorter(sorter);
```

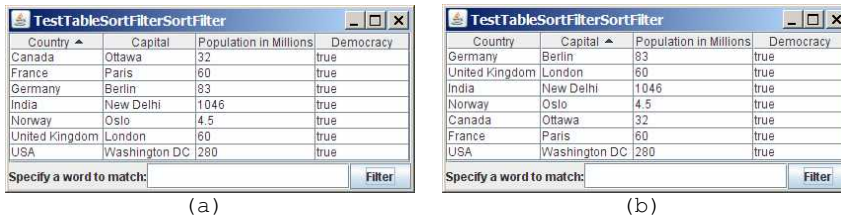


Figure 40.11

(a) The table is sorted on Country. (b) The table is sorted on Capital.

When the table is displayed, you can sort the table by clicking a column head, as shown in Figure 40.11.

You can specify a filter to select rows in the table. The filter can be applied on one column or all columns. The `javax.swing.RowFilter` class contains several static methods for creating filters. You can use the `regexFilter` method to create a `RowFilter` with the specified regular expression. For example, the following statement creates a filter for the rows whose first column or second column begin with letter `U`.

**<margin note: create a filter>**

```
RowFilter rowFilter = RowFilter.regexFilter("U.*", int[]{0, 1});
```

The second argument in the `regexFilter` method specifies a set of column indices. If no indices are specified, all columns are searched in the filter.

**<margin note: set filter in `JTable`>**

To enable filtering, you have to associate a filter with a `TableRowSorter`, which is set to the `JTable`'s `rowSorter` property.

Listing 40.5 gives an example that demonstrates auto sort and filtering in `JTable`.

Listing 40.5 `TestTableSortFilter.java`

**<margin note line 7: column names>**

**<margin note line 11: row data>**

**<margin note line 22: create table>**

**<margin note line 25: create `TableRowSorter`>**

<margin note line 33: set sorter>  
 <margin note line 49: remove filter>  
 <margin note line 51: set a filter>  
 <margin note line 55: main method omitted>

```

1 import javax.swing.*;
2 import javax.swing.table.*;
3 import java.awt.BorderLayout;
4
5 public class TestTableSortFilter extends JApplet {
6 // Create table column names
7 private String[] columnNames =
8 {"Country", "Capital", "Population in Millions", "Democracy"};
9
10 // Create table data
11 private Object[][] data = {
12 {"USA", "Washington DC", 280, true},
13 {"Canada", "Ottawa", 32, true},
14 {"United Kingdom", "London", 60, true},
15 {"Germany", "Berlin", 83, true},
16 {"France", "Paris", 60, true},
17 {"Norway", "Oslo", 4.5, true},
18 {"India", "New Delhi", 1046, true}
19 };
20
21 // Create a table
22 private JTable jTable1 = new JTable(data, columnNames);
23
24 // Create a TableRowSorter
25 private TableRowSorter<TableModel> sorter =
26 new TableRowSorter<TableModel>(jTable1.getModel());
27
28 private JTextField jtffilter = new JTextField();
29 private JButton btFilter = new JButton("Filter");
30
31 public TestTableSortFilter() {
32 // Enable auto sorter
33 jTable1.setRowSorter(sorter);
34
35 JPanel panel = new JPanel(new java.awt.BorderLayout());
36 panel.add(new JLabel("Specify a word to match:"),
37 BorderLayout.WEST);
38 panel.add(jtffilter, BorderLayout.CENTER);
39 panel.add(btFilter, BorderLayout.EAST);
40
41 add(panel, BorderLayout.SOUTH);
42 add(new JScrollPane(jTable1), BorderLayout.CENTER);
43
44 btFilter.addActionListener(new java.awt.event.ActionListener()
45 {
46 @Override
47 public void actionPerformed(java.awt.event.ActionEvent e) {
48 String text = jtffilter.getText();
49 if (text.trim().length() == 0)
50 sorter.setRowFilter(null);
51 else
52 sorter.setRowFilter(RowFilter.regexFilter(text));
53 }
54 });
55 }

```

```

54 }
55 }

```

The example creates a `TableRowSorter` (line 25) and sets the sorter in `jTable1` (line 33). The program lets the user enter a filter pattern from a text field, as shown in Figure 40.12. If nothing is entered, no filter is set (line 48). If a regex is entered, clicking the *Filter* button sets the filter to `jTable1` (line 50).

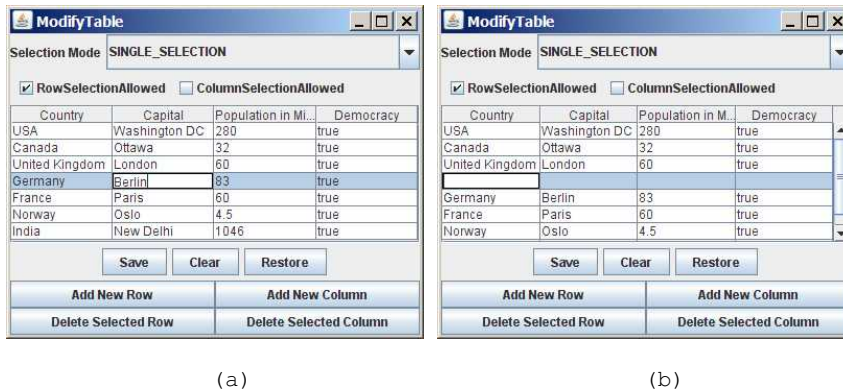


**Figure 40.12**

(a) Filter the table with regex `U.*`. (b) Filter the table with regex `w`.

### 40.5 Case Study: Modifying Rows and Columns

This case study demonstrates the use of table models, table column models, list-selection models, and the `TableColumn` class. The program allows the user to choose selection mode and selection type, add or remove rows and columns, and save, clear, or restore the table, as shown in Figure 40.13a.



**Figure 40.13**

*You can add, remove, and modify rows and columns in a table interactively.*

The *Add New Row* button adds a new empty row before the currently selected row, as shown in Figure 40.13b. If no row is currently selected, a new empty row is appended to the end of the table.

When you click the *Add New Column* button, an input dialog box is displayed to receive the title of the column, as shown in Figure 40.14a. The new column is appended in the table, as shown in Figure 40.14b.



(a)



(b)

**Figure 40.14**

You can add a new column in a table.

The *Delete Selected Row* button deletes the first selected row. The *Delete Selected Column* button deletes the first selected column.

The *Save* button saves the current table data and column names. The *Clear* button clears the row data in the table. The *Restore* button restores the saved table.

Listing 40.6 gives the program.

**Listing 40.6 ModifyTable.java**

```

<margin note line 10: column names>
<margin note line 14: table data>
<margin note line 25: table model>
<margin note line 29: table>
<margin note line 32: buttons>
<margin note line 42: combo box>
<margin note line 47: check boxes>
<margin note line 53: create UI>
<margin note line 93: add row>
<margin note line 104: add column>
<margin note line 112: delete row>
<margin note line 120: delete column>
<margin note line 132: save table>
<margin note line 148: clear table>
<margin note line 155: restore table>
<margin note line 173: row selection allowed>
<margin note line 181: column selection allowed>
<margin note line 190: choose selection mode>
<margin note line 209: get column names>
<margin note line 217: main method omitted>

```

```

1 import java.awt.*;
2 import java.awt.event.*;
3 import javax.swing.*;
4 import javax.swing.table.*;
5 import java.io.*;
6 import java.util.Vector;
7
8 public class ModifyTable extends JApplet {

```

```

9 // Create table column names
10 private String[] columnNames =
11 {"Country", "Capital", "Population in Millions", "Democracy"};
12
13 // Create table data
14 private Object[][] rowData = {
15 {"USA", "Washington DC", 280, true},
16 {"Canada", "Ottawa", 32, true},
17 {"United Kingdom", "London", 60, true},
18 {"Germany", "Berlin", 83, true},
19 {"France", "Paris", 60, true},
20 {"Norway", "Oslo", 4.5, true},
21 {"India", "New Delhi", 1046, true}
22 };
23
24 // Create a table model
25 private DefaultTableModel tableModel = new DefaultTableModel(
26 rowData, columnNames);
27
28 // Create a table
29 private JTable jTable1 = new JTable(tableModel);
30
31 // Create buttons
32 private JButton jbtAddRow = new JButton("Add New Row");
33 private JButton jbtAddColumn = new JButton("Add New Column");
34 private JButton jbtDeleteRow = new JButton("Delete Selected Row");
35 private JButton jbtDeleteColumn = new JButton(
36 "Delete Selected Column");
37 private JButton jbtSave = new JButton("Save");
38 private JButton jbtClear = new JButton("Clear");
39 private JButton jbtRestore = new JButton("Restore");
40
41 // Create a combo box for selection modes
42 private JComboBox jcboSelectionMode =
43 new JComboBox(new String[] {"SINGLE_SELECTION",
44 "SINGLE_INTERVAL_SELECTION", "MULTIPLE_INTERVAL_SELECTION"});
45
46 // Create check boxes
47 private JCheckBox jchkRowSelectionAllowed =
48 new JCheckBox("RowSelectionAllowed", true);
49 private JCheckBox jchkColumnSelectionAllowed =
50 new JCheckBox("ColumnSelectionAllowed", false);
51
52 public ModifyTable() {
53 JPanel panel1 = new JPanel();
54 panel1.setLayout(new GridLayout(2, 2));
55 panel1.add(jbtAddRow);
56 panel1.add(jbtAddColumn);
57 panel1.add(jbtDeleteRow);
58 panel1.add(jbtDeleteColumn);
59
60 JPanel panel2 = new JPanel();
61 panel2.add(jbtSave);
62 panel2.add(jbtClear);
63 panel2.add(jbtRestore);
64
65 JPanel panel3 = new JPanel();
66 panel3.setLayout(new BorderLayout(5, 0));
67 panel3.add(new JLabel("Selection Mode"), BorderLayout.WEST);
68 panel3.add(jcboSelectionMode, BorderLayout.CENTER);
69
70 JPanel panel4 = new JPanel();
71 panel4.setLayout(new FlowLayout(FlowLayout.LEFT));
72 panel4.add(jchkRowSelectionAllowed);
73 panel4.add(jchkColumnSelectionAllowed);
74

```

```

75 JPanel panel5 = new JPanel();
76 panel5.setLayout(new GridLayout(2, 1));
77 panel5.add(panel3);
78 panel5.add(panel4);
79
80 JPanel panel6 = new JPanel();
81 panel6.setLayout(new BorderLayout());
82 panel6.add(panel1, BorderLayout.SOUTH);
83 panel6.add(panel2, BorderLayout.CENTER);
84
85 add(panel5, BorderLayout.NORTH);
86 add(new JScrollPane(jTable1),
87 BorderLayout.CENTER);
88 add(panel6, BorderLayout.SOUTH);
89
90 // Initialize table selection mode
91 jTable1.setSelectionMode(ListSelectionModel.SINGLE_SELECTION);
92
93 jbtAddRow.addActionListener(new ActionListener() {
94 @Override
95 public void actionPerformed(ActionEvent e) {
96 if (jTable1.getSelectedRow() >= 0)
97 tableModel.insertRow(jTable1.getSelectedRow(),
98 new java.util.Vector<String>());
99 else
100 tableModel.addRow(new java.util.Vector<String>());
101 }
102 });
103
104 jbtAddColumn.addActionListener(new ActionListener() {
105 @Override
106 public void actionPerformed(ActionEvent e) {
107 String name = JOptionPane.showInputDialog("New Column Name");
108 tableModel.addColumn(name, new java.util.Vector());
109 }
110 });
111
112 jbtDeleteRow.addActionListener(new ActionListener() {
113 @Override
114 public void actionPerformed(ActionEvent e) {
115 if (jTable1.getSelectedRow() >= 0)
116 tableModel.removeRow(jTable1.getSelectedRow());
117 }
118 });
119
120 jbtDeleteColumn.addActionListener(new ActionListener() {
121 @Override
122 public void actionPerformed(ActionEvent e) {
123 if (jTable1.getSelectedColumn() >= 0) {
124 TableColumnModel columnModel = jTable1.getColumnModel();
125 TableColumn tableColumn =
126 columnModel.getColumn(jTable1.getSelectedColumn());
127 columnModel.removeColumn(tableColumn);
128 }
129 }
130 });
131
132 jbtSave.addActionListener(new ActionListener() {
133 @Override
134 public void actionPerformed(ActionEvent e) {
135 try {
136 ObjectOutputStream out = new ObjectOutputStream(
137 new FileOutputStream("tableModel.dat"));
138 out.writeObject(tableModel.getDataVector());
139 out.writeObject(getColumnNames());
140 out.close();

```

```

141 }
142 catch (Exception ex) {
143 ex.printStackTrace();
144 }
145 }
146 });
147
148 jbtClear.addActionListener(new ActionListener() {
149 @Override
150 public void actionPerformed(ActionEvent e) {
151 tableModel.setRowCount(0);
152 }
153 });
154
155 jbtRestore.addActionListener(new ActionListener() {
156 @Override
157 public void actionPerformed(ActionEvent e) {
158 try {
159 ObjectInputStream in = new ObjectInputStream(
160 new FileInputStream("tablemodel.dat"));
161 Vector<String> rowData = (Vector<String>)in.readObject();
162 Vector<String> columnNames =
163 (Vector<String>)in.readObject();
164 tableModel.setDataVector(rowData, columnNames);
165 in.close();
166 }
167 catch (Exception ex) {
168 ex.printStackTrace();
169 }
170 }
171 });
172
173 jchkRowSelectionAllowed.addActionListener(new ActionListener() {
174 @Override
175 public void actionPerformed(ActionEvent e) {
176 jTable1.setRowSelectionAllowed(
177 jchkRowSelectionAllowed.isSelected());
178 }
179 });
180
181 jchkColumnSelectionAllowed.addActionListener(
182 new ActionListener() {
183 @Override
184 public void actionPerformed(ActionEvent e) {
185 jTable1.setColumnSelectionAllowed(
186 jchkColumnSelectionAllowed.isSelected());
187 }
188 });
189
190 jcboSelectionMode.addActionListener(new ActionListener() {
191 @Override
192 public void actionPerformed(ActionEvent e) {
193 String selectedItem =
194 (String)jcboSelectionMode.getSelectedItem();
195
196 if (selectedItem.equals("SINGLE_SELECTION"))
197 jTable1.setSelectionMode(
198 ListSelectionModel.SINGLE_SELECTION);
199 else if (selectedItem.equals("SINGLE_INTERVAL_SELECTION"))
200 jTable1.setSelectionMode(
201 ListSelectionModel.SINGLE_INTERVAL_SELECTION);
202 else if (selectedItem.equals("MULTIPLE_INTERVAL_SELECTION"))
203 jTable1.setSelectionMode(
204 ListSelectionModel.MULTIPLE_INTERVAL_SELECTION);
205 }
206 });

```



```

207 }
208
209 private Vector<String> getColumnNames() {
210 Vector<String> columnNames = new Vector<String>();
211
212 for (int i = 0; i < jTable1.getColumnCount(); i++)
213 columnNames.add(jTable1.getColumnName(i));
214
215 return columnNames;
216 }
217 }

```

A table model is created using DefaultTableModel with row data and column names (lines 25-26). This model is used to create a JTable (line 29).

The GUI objects (buttons, combo box, check boxes) are created in lines 32-50 and are placed in the UI in lines 53-88.

The table-selection mode is the same as the list-selection mode. By default, the selection mode is MULTIPLE INTERVAL SELECTION. To match the initial value in the selection combo box (jcboSelectionMode), the table's selection mode is set to SINGLE SELECTION.

The *Add New Row* button action is processed in lines 93-102. The insertRow method inserts a new row before the selected row (lines 97-98). If no row is currently selected, the addRow method appends a new row into the table model (line 100).

The *Add New Column* button action is processed in lines 104-110. The addColumn method appends a new column into the table model (line 108).

The *Delete Selected Row* button action is processed in lines 112-118. The removeRow(rowIndex) method removes the selected row from the table model (line 116).

The *Delete Selected Column* button action is processed in lines 120-130. To remove a column, you have to use the removeColumn method in TableColumnModel (line 127).

The *Save* button action is processed in lines 132-146. It writes row data and column names to an output file using object stream (lines 136-140). The column names are obtained using the getColumnNames() method (lines 209-216). You may attempt to save tableModel, because tableModel is an instance of DefaultTableModel (lines 25-26) and DefaultTableModel is serializable. However, tableModel may contain nonserializable listeners for TableModel event.

The *Clear* button action is processed in lines 148-153. It clears the table by setting the row count to 0 (line 151).

The *Restore* button action is processed in lines 155-171. It reads row data and column names from the file using object stream (lines 159-165) and sets the new data and column names to the table model (line 164).

## 40.6 Table Renderers and Editors

Table cells are painted by cell renderers. By default, a cell object's string representation (`toString()`) is displayed and the string can be edited as it was in a text field. `JTable` maintains a set of predefined renderers and editors, listed in Table 40.1, which can be specified to replace default string renderers and editors.

Table 40.1

*Predefined renderers and editors for tables*

<b>Class</b>	<b>Renderer</b>	<b>Editor</b>
<code>Object</code>	<code>JLabel</code> (left aligned)	<code>JTextField</code>
<code>Date</code>	<code>JLabel</code> (right aligned)	<code>JTextField</code>
<code>Number</code>	<code>JLabel</code> (right aligned)	<code>JTextField</code>
<code>ImageIcon</code>	<code>JLabel</code> (center aligned)	
<code>Boolean</code> aligned)	<code>JCheckBox</code> (center aligned)	<code>JCheckBox</code> (center aligned)

The predefined renderers and editors are automatically located and loaded to match the class returned from the `getColumnClass()` method in the table model. To use a predefined renderer or editor for a class other than `String`, you need to create your own table model by extending a subclass of `TableModel`. In your table model class, you need to override the `getColumnClass()` method to return the class of the column, as follows:

```

public Class getColumnClass(int column) {
 return getValueAt(0, column).getClass();
}

```

By default, all cells are editable. To prohibit a cell from being edited, override the `isCellEditable(int rowIndex, int columnIndex)` method in `TableModel` to return `false`. By default, this method returns `true` in `AbstractTableModel`.

To demonstrate predefined table renderers and editors, let us write a program that displays a table for books. The table consists of three rows with the column names Title, Copies Needed, Publisher, Date Published, In-Stock, and Book Photo, as shown in Figure 40.15. Assume that dates and icons are not editable; prohibit users from editing these two columns.

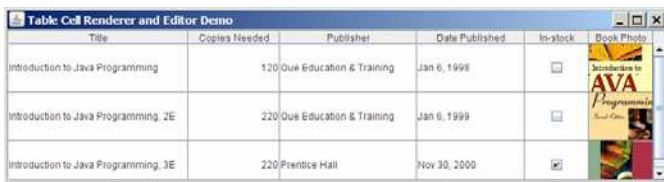


Figure 40.15

*You need to use a custom table model to enable predefined renderers for Boolean and image cells.*

Listing 40.7 gives a custom table model named `MyTableModel` that overrides the `getColumnClass` method (lines 15-17) to enable predefined renderers for Boolean and image cells. `MyTableModel` also overrides the `isCellEditable()` method (lines 20-24). By default, `isCellEditable()` returns `true`. The example does not allow the user to edit image icons and dates, so this method is overridden to return `false` to disable editing of date and image columns. For a cell to be editable, both `isCellEditable()` in the table model must be `true`.

**Listing 40.7 MyTableModel.java**

*<margin note line 15: column class>*  
*<margin note line 20: cell editable?>*

```
import javax.swing.*;
import javax.swing.table.*;
import java.util.*;

public class MyTableModel extends DefaultTableModel {
 public MyTableModel() {
 }

 /** Construct a table model with specified data and columnNames */
 public MyTableModel(Object[][] data, Object[] columnNames) {
 super(data, columnNames);
 }

 /** Override this method to return a class for the column */
 public Class getColumnClass(int column) {
 return getValueAt(0, column).getClass();
 }

 /** Override this method to return true if cell is editable */
 public boolean isCellEditable(int row, int column) {
 Class columnClass = getColumnClass(column);
 return columnClass != ImageIcon.class &&
 columnClass != Date.class;
 }
}
```

If you create a `JTable` using a table model created from `MyTableModel`, the default renderers and editors for numbers, Boolean values, dates, and icons are used to display and edit these columns. Listing 40.8 gives a test program. The program creates a table model using `MyTableModel` (line 36). `JTable` assigns a predefined cell renderer and a predefined editor to the cell, whose class is specified in the `getColumnClass()` method in `MyTableModel`.

**Listing 40.8 TableCellRendererEditorDemo.java**

*<margin note line 7: column names>*  
*<margin note line 12: image icons>*  
*<margin note line 20: row data>*  
*<margin note line 36: table model>*  
*<margin note line 40: table>*  
*<margin note line 47: main method omitted>*

```
import java.awt.*;
import javax.swing.*;
import java.util.*;

public class TableCellRendererEditorDemo extends JApplet {
 // Create table column names
 private String[] columnNames =
 {"Title", "Copies Needed", "Publisher", "Date Published",
 "In-stock", "Book Photo"};
}
```

```

 // Create image icons
 private ImageIcon intro1eImageIcon = new ImageIcon(
 getClass().getResource("image/intro1e.gif"));
 private ImageIcon intro2eImageIcon = new ImageIcon(
 getClass().getResource("image/intro2e.gif"));
 private ImageIcon intro3eImageIcon = new ImageIcon(
 getClass().getResource("image/intro3e.jpg"));

 // Create table data
 private Object[][] rowData = {
 {"Introduction to Java Programming", 120,
 "Que Education & Training",
 new GregorianCalendar(1998, 1-1, 6).getTime(),
 false, intro1eImageIcon},
 {"Introduction to Java Programming, 2E", 220,
 "Que Education & Training",
 new GregorianCalendar(1999, 1-1, 6).getTime(),
 false, intro2eImageIcon},
 {"Introduction to Java Programming, 3E", 220,
 "Prentice Hall",
 new GregorianCalendar(2000, 12-1, 0).getTime(),
 true, intro3eImageIcon},
 };

 // Create a table model
 private MyTableModel tableModel = new MyTableModel(
 rowData, columnNames);

 // Create a table
 private JTable jTable1 = new JTable(tableModel);

 public TableCellRendererEditorDemo() {
 jTable1.setRowHeight(60);
 add(new JScrollPane(jTable1), BorderLayout.CENTER);
 }
}

```

The example defines two classes: `MyTableModel` and `TableCellRendererEditorDemo`. `MyTableModel` is an extension of `DefaultTableModel`. The purpose of `MyTableModel` is to override the default implementation of the `getColumnClass()` method to return the class of the column, so that an appropriate predefined `JTable` can be used for the column. By default, `getColumnClass()` returns `Object.class`.

#### 40.7 Custom Table Renderers and Editors

Predefined renderers and editors are convenient and easy to use, but their functions are limited. The predefined image icon renderer displays the image icon in a label. The image icon cannot be scaled. If you want the whole image to fit in a cell, you need to create a custom renderer.

A custom renderer can be created by extending the `DefaultTableCellRenderer`, which is a default implementation for the `TableCellRenderer` interface. The custom renderer must override the `getTableCellRendererComponent` method to return a component for rendering the table cell. The `getTableCellRendererComponent` method is defined as follows:

```

public Component getTableCellRendererComponent
(JTable table, Object value, boolean isSelected,
boolean isFocused, int row, int column)

```

This method signature is very similar to the `getListCellRendererComponent()` method used to create custom list cell renderers.

This method is passed with a `JTable`, the value associated with the cell, information regarding whether the value is selected and whether the cell has the focus, and the row and column indices of the value. The component returned from the method is painted on the cell in the table. The class in Listing 40.9, `MyImageCellRenderer`, defines a renderer for displaying image icons in a panel.

**Listing 40.9** `MyImageCellRenderer.java`

<margin note line 7: *override method*>  
 <margin note line 10: *getImage()*>  
 <margin note line 11: *create image viewer*>  
 <margin note line 13: *return image viewer*>




```
import javax.swing.*;
import javax.swing.table.*;
import java.awt.*;

public class MyImageCellRenderer extends DefaultTableCellRenderer {
 /** Override this method in DefaultTableCellRenderer */
 public Component getTableCellRendererComponent
 (JTable table, Object value, boolean isSelected,
 boolean isFocused, int row, int column) {
 Image image = ((ImageIcon)value).getImage();
 ImageViewer imageView = new ImageViewer(image);

 return imageView;
 }
}
```

You can also create a custom editor. `JTable` provides the `DefaultCellEditor` class, which can be used to edit a cell in a text field, a check box, or a combo box. To use it, simply create a text field, a check box, or a combo box, and pass it to `DefaultCellEditor`'s constructor to create an editor.

Using a custom renderer and editor, the preceding example can be revised to display scaled images and to use a custom combo editor to edit the cells in the Publisher column, as shown in Figure 40.16. The program is given in Listing 40.10.

Title	Copies Needed	Publisher	Date Published	In-stock	Book Photo
Introduction to Java Programming	120	Que Education & Tr...	Jan 6, 1998	<input type="checkbox"/>	
Introduction to Java Programming, 2E	220	Que Education & Training McGraw-Hill	Jan 6, 1999	<input type="checkbox"/>	
Introduction to Java Programming, 3E	220	Prentice Hall	Nov 30, 2000	<input checked="" type="checkbox"/>	

**Figure 40.16**

*A custom renderer displays a scaled image, and a custom editor edits the Publisher column using a combo box.*

**Listing 40.10** `CustomTableCellRendererEditorDemo.java`

<margin note line 8: *column names*>

<margin note line 13: image icons>  
 <margin note line 21: row data>  
 <margin note line 37: table model>  
 <margin note line 41: table>  
 <margin note line 46: set renderer>  
 <margin note line 49: combo box>  
 <margin note line 56: set editor>  
 <margin note line 63: main method omitted>

```

import java.awt.*;
import javax.swing.*;
import javax.swing.table.*;
import java.util.*;

public class CustomTableCellRendererEditorDemo extends JApplet {
 // Create table column names
 private String[] columnNames =
 {"Title", "Copies Needed", "Publisher", "Date Published",
 "In-stock", "Book Photo"};

 // Create image icons
 private ImageIcon intro1eImageIcon =
 new ImageIcon(getClass().getResource("image/intro1e.gif"));
 private ImageIcon intro2eImageIcon =
 new ImageIcon(getClass().getResource("image/intro2e.gif"));
 private ImageIcon intro3eImageIcon =
 new ImageIcon(getClass().getResource("image/intro3e.jpg"));

 // Create table data
 private Object[][] rowData = {
 {"Introduction to Java Programming", 120,
 "Que Education & Training",
 new GregorianCalendar(1998, 1-1, 6).getTime(),
 false, intro1eImageIcon},
 {"Introduction to Java Programming, 2E", 220,
 "Que Education & Training",
 new GregorianCalendar(1999, 1-1, 6).getTime(),
 false, intro2eImageIcon},
 {"Introduction to Java Programming, 3E", 220,
 "Prentice Hall",
 new GregorianCalendar(2000, 12-1, 0).getTime(),
 true, intro3eImageIcon},
 };

 // Create a table model
 private MyTableModel tableModel = new MyTableModel(
 rowData, columnNames);

 // Create a table
 private JTable jTable1 = new JTable(tableModel);

 public CustomTableCellRendererEditorDemo() {
 // Set custom renderer for displaying images
 TableColumn bookCover = jTable1.getColumn("Book Photo");
 bookCover.setCellRenderer(new MyImageCellRenderer());

 // Create a combo box for publishers
 JComboBox jchoPublishers = new JComboBox();
 jchoPublishers.addItem("Prentice Hall");
 jchoPublishers.addItem("Que Education & Training");
 jchoPublishers.addItem("McGraw-Hill");

 // Set combo box as the editor for the publisher column
 TableColumn publisherColumn = jTable1.getColumn("Publisher");
 publisherColumn.setCellEditor(
 new DefaultCellEditor(jchoPublishers));

 jTable1.setRowHeight(60);
 add(new JScrollPane(jTable1),
 BorderLayout.CENTER);
 }

```

1  
1

This example uses the same table model (`MyTableModel`) that was created in the preceding example (lines 37-38). By default, image icons are displayed using the predefined image icon renderer. To use `MyImageCellRenderer` to display the image, you have to explicitly specify the `MyImageCellRenderer` renderer for the Book Photo column (line 46). Likewise, you have to explicitly specify the combo box editor for the Publisher column (lines 56-57); otherwise the default editor would be used.

When you edit a cell in the Publisher column, a combo box of three items is displayed. When you select an item from the box, it is displayed in the cell. You did not write the code for handling selections. The selections are handled by the `DefaultCellEditor` class.

When you resize the Book Photo column, the image is resized to fit into the whole cell. With the predefined image renderer, you can see only part of the image if the cell is smaller than the image.

#### 40.8 Table Model Events

`JTable` does not fire table events. It fires events like `MouseEvent`, `KeyEvent`, and `ComponentEvent` that are inherited from its superclass, `JComponent`. Table events are fired by table models, table column models, and table-selection models whenever changes are made to these models. Table models fire `TableModelEvent` when table data are changed. Table column models fire `TableColumnModelEvent` when columns are added, removed, or moved, or when a column is selected. Table-selection models fire `ListSelectionEvent` when a selection is made.

To listen for these events, a listener must be registered with an appropriate model and implement the correct listener interface. Listing 40.11 gives an example that demonstrates how to use these events. The program displays messages on a text area when a row or a column is selected, when a cell is edited, or when a column is removed. Figure 40.17 is a sample run of the program.

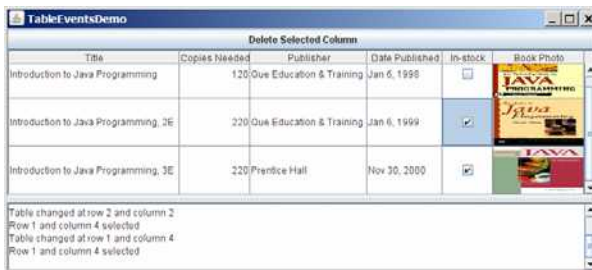


Figure 40.17

*Table event handlers display table events on a text area.*

**Listing 40.11** `TableEventsDemo.java`

<margin note line 10: column names>  
 <margin note line 15: image icons>  
 <margin note line 23: table data>  
 <margin note line 39: table model>  
 <margin note line 43: table>  
 <margin note line 46: column model>  
 <margin note line 50: selection model>  
 <margin note line 86: table model listener>  
 <margin note line 94: column model listener>  
 <margin note line 131: selection model listener>  
 <margin note line 141: main method omitted>

```

1 import java.awt.*;
2 import java.awt.event.*;
3 import javax.swing.*;
4 import javax.swing.event.*;
5 import javax.swing.table.*;
6 import java.util.*;
7
8 public class TableEventsDemo extends JApplet {
9 // Create table column names
10 private String[] columnNames =
11 {"Title", "Copies Needed", "Publisher", "Date Published",
12 "In-stock", "Book Photo"};
13
14 // Create image icons
15 private ImageIcon intro1eImageIcon =
16 new ImageIcon(getClass().getResource("/image/intro1e.gif"));
17 private ImageIcon intro2eImageIcon =
18 new ImageIcon(getClass().getResource("/image/intro2e.gif"));
19 private ImageIcon intro3eImageIcon =
20 new ImageIcon(getClass().getResource("/image/intro3e.jpg"));
21
22 // Create table data
23 private Object[][] rowData = {
24 {"Introduction to Java Programming", 120,
25 "Que Education & Training",
26 new GregorianCalendar(1998, 1-1, 6).getTime(),
27 false, intro1eImageIcon},
28 {"Introduction to Java Programming, 2E", 220,
29 "Que Education & Training",
30 new GregorianCalendar(1999, 1-1, 6).getTime(),
31 false, intro2eImageIcon},
32 {"Introduction to Java Programming, 3E", 220,
33 "Prentice Hall",
34 new GregorianCalendar(2000, 12-1, 0).getTime(),
35 true, intro3eImageIcon},
36 };
37
38 // Create a table model
39 private MyTableModel tableModel = new MyTableModel(
40 rowData, columnNames);
41
42 // Create a table
43 private JTable jTable1 = new JTable(tableModel);
44
45 // Get table column model
46 private TableColumnModel tableColumnModel =
47 jTable1.getColumnModel();
48
49 // Get table selection model
50 private ListSelectionModel selectionModel =
51 jTable1.getSelectionModel();
52
53 // Create a text area

```



```

54 private JTextArea jtaMessage = new JTextArea();
55
56 // Create a button
57 private JButton jbtDeleteColumn =
58 new JButton("Delete Selected Column");
59
60 public TableEventsDemo() {
61 // Set custom renderer for displaying images
62 TableColumn bookCover = jTable1.getColumn("Book Photo");
63 bookCover.setCellRenderer(new MyImageCellRenderer());
64
65 // Create a combo box for publishers
66 JComboBox jcboPublishers = new JComboBox();
67 jcboPublishers.addItem("Prentice Hall");
68 jcboPublishers.addItem("Que Education & Training");
69 jcboPublishers.addItem("McGraw-Hill");
70
71 // Set combo box as the editor for the publisher column
72 TableColumn publisherColumn = jTable1.getColumn("Publisher");
73 publisherColumn.setCellEditor(
74 new DefaultCellEditor(jcboPublishers));
75
76 jTable1.setRowHeight(60);
77 jTable1.setColumnSelectionAllowed(true);
78
79 JSplitPane jSplitPanel = new JSplitPane(
80 JSplitPane.VERTICAL_SPLIT);
81 jSplitPanel.add(new JScrollPane(jTable1), JSplitPane.LEFT);
82 jSplitPanel.add(new JScrollPane(jtaMessage), JSplitPane.RIGHT);
83 add(jbtDeleteColumn, BorderLayout.NORTH);
84 add(jSplitPanel, BorderLayout.CENTER);
85
86 tableModel.addTableModelListener(new TableModelListener() {
87 @Override
88 public void tableChanged(TableModelEvent e) {
89 jtaMessage.append("Table changed at row " +
90 e.getFirstRow() + " and column " + e.getColumn() + "\n");
91 }
92 });
93
94 tableColumnModel.addColumnModelListener(
95 new TableColumnModelListener() {
96 @Override
97 public void columnRemoved(TableColumnModelEvent e) {
98 jtaMessage.append("Column indexed at " + e.getFromIndex() +
99 " is deleted \n");
100 }
101
102 @Override
103 public void columnAdded(TableColumnModelEvent e) {
104 }
105
106 @Override
107 public void columnMoved(TableColumnModelEvent e) {
108 }
109
110 @Override
111 public void columnMarginChanged(ChangeEvent e) {
112 }
113
114 @Override
115 public void columnSelectionChanged(ListSelectionEvent e) {
116 }
117 });
118
119 jbtDeleteColumn.addActionListener(new ActionListener() {

```

```

120 @Override
121 public void actionPerformed(ActionEvent e) {
122 if (jTable1.getSelectedColumn() >= 0) {
123 TableColumnModel columnModel = jTable1.getColumnModel();
124 TableColumn tableColumn =
125 columnModel.getColumn(jTable1.getSelectedColumn());
126 columnModel.removeColumn(tableColumn);
127 }
128 }
129 });
130
131 selectionModel.addListSelectionListener(
132 new ListSelectionListener() {
133 @Override
134 public void valueChanged(ListSelectionEvent e) {
135 jtaMessage.append("Row " + jTable1.getSelectedRow() +
136 " and column " + jTable1.getSelectedColumn() +
137 " selected\n");
138 }
139 });
140 }
141 }

```

To respond to the row and column selection events, you need to implement the `valueChanged` method in `ListSelectionListener`. To respond to the cell-editing event, you need to implement the `tableChanged` method in `TableModelListener`. To respond to the column-deletion event, you need to implement the `columnRemoved` method in `TableColumnModelListener`. Let's use the same table from the preceding example, but with a button added for deleting the selected column and a text area for displaying the messages.

A table model is created using `MyTableModel` (lines 39-40), which was given in Listing 40.7. When a table is created (line 43), its default column model and selection model are also created. Therefore, you can obtain the table column model and selection model from the table (lines 46-51).

When a row or a column is selected, a `ListSelectionEvent` is fired by `selectionModel`, which invokes the handler to display the selected row and column in the text area (lines 134-138). When the content or structure of the table is changed, a `TableModelEvent` is fired by `tableModel`, which invokes the handler to display the last row and last column of the changed data in the text area (lines 88-91). When a column is deleted by clicking the *Delete Selected Column* button, a `ColumnModelEvent` is fired by `tableColumnModel`, which invokes the handler to display the index of the deleted column (lines 97-100).

## 40.9 JTree

`JTree` is a Swing component that displays data in a treelike hierarchy, as shown in Figure 40.18.



**Figure 40.18**

*JTree displays data in a treelike hierarchy.*

All the nodes displayed in the tree are in the form of a hierarchical indexed list. The tree can be used to navigate structured data with hierarchical relationships. A node can have child nodes. A node is called a *leaf* if it has no children; a node with no parent is called the *root* of its tree. A tree may consist of many subtrees, each node acting as the root for its own subtree.

A nonleaf node can be expanded or collapsed by double-clicking on the node or on the node's handle in front of the node. The handle usually has a visible sign to indicate whether the node is expanded or collapsed. For example, on Windows, the + symbol indicates that the node can be expanded, and the - symbol, that it can be collapsed.

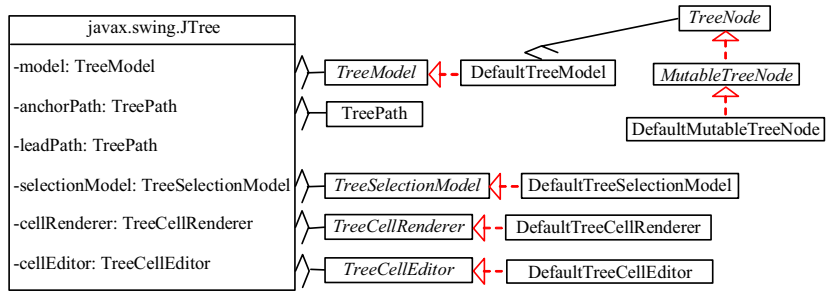
Like JTable, JTree is a very complex component with many supporting interfaces and classes. JTree is in the javax.swing package, but its supporting interfaces and classes are all included in the javax.swing.tree package. The supporting interfaces are TreeModel, TreeSelectionModel, TreeNode, and MutableTreeNode, and the supporting classes are DefaultTreeModel, DefaultMutableTreeNode, DefaultTreeCellEditor, DefaultTreeCellRenderer, and TreePath.

While JTree displays the tree, the data representation of the tree is handled by TreeModel, TreeNode, and TreePath. TreeModel represents the entire tree, TreeNode represents a node, and TreePath represents a path to a node. Unlike the ListModel or TableModel, TreeModel does not directly store or manage tree data. Tree data are stored and managed in TreeNode and TreePath. DefaultTreeModel is a concrete implementation of TreeModel. MutableTreeNode is a subinterface of TreeNode, which represents a tree node that can be mutated by adding or removing child nodes, or by changing the contents of a user object stored in the node.

The TreeSelectionModel interface handles tree node selection. The DefaultTreeCellRenderer class provides a default tree node renderer that can display a label and/or an icon in a node. The DefaultTreeCellEditor can be used to edit the cells in a text field.

A TreePath is an array of Objects that are vended from a TreeModel. The elements of the array are ordered such that the

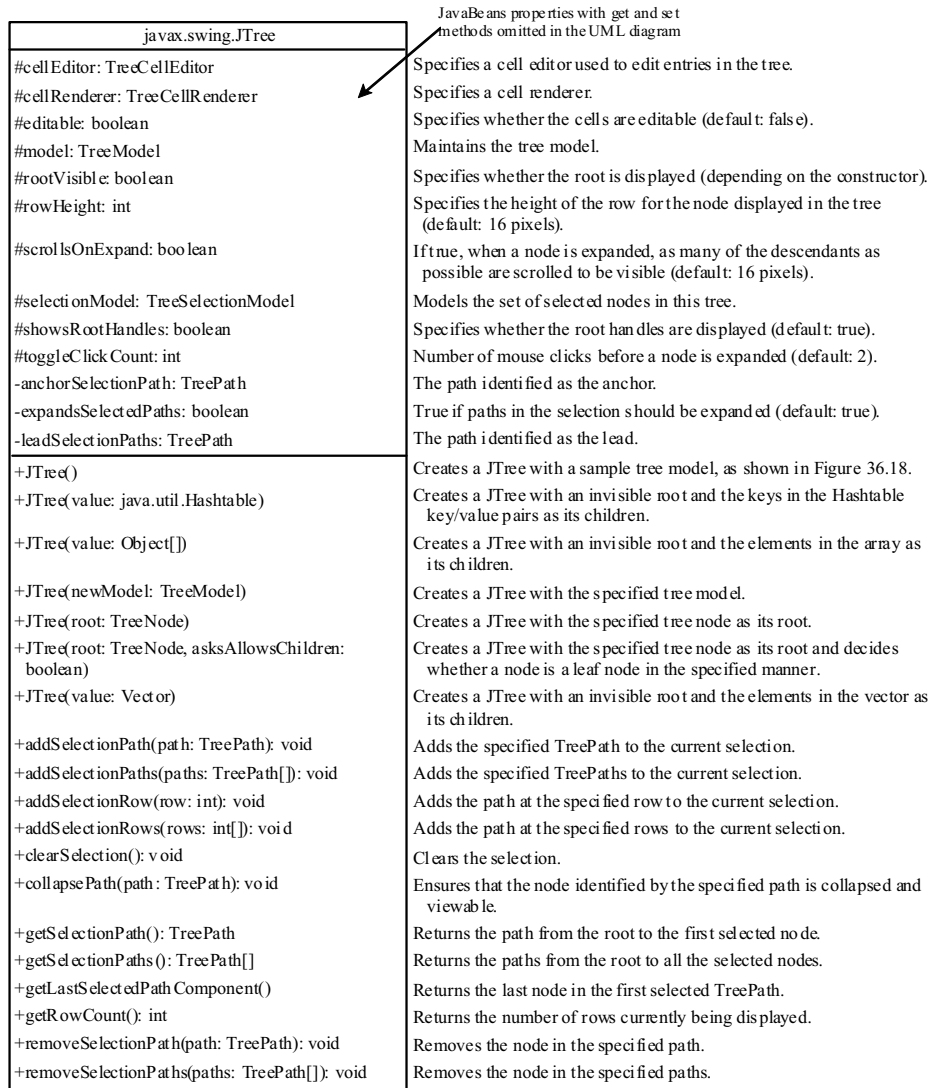
root is always the first element (index 0) of the array. Figure 40.19 shows how these interfaces and classes are interrelated.



**Figure 40.19**

*JTree* contains many supporting interfaces and classes.

Figure 40.20 shows the constructors, frequently used properties, and methods of `JTree`.



**Figure 40.20**

*The `JTree` class is for creating, customizing, and manipulating trees.*

The `JTree` class contains seven constructors for creating trees. You can create a tree using its no-arg constructor, a tree model, a tree node, a `Hashtable`, an array, or a vector. Using the no-arg constructor, a sample tree is created as shown in Figure 40.18. Using a `Hashtable`, an array, or a vector, a root is created but not displayed. All the keys in a `Hashtable`, all the objects in an array, and all the elements in a vector are added into the tree as children of the root. If you wish the root to be displayed, set the `rootVisible` property to true.

All the methods related to path selection are also defined in the `TreeSelectionModel` interface, which will be covered in §40.12, "[TreePath](#) and [TreeSelectionModel](#)."

Listing 40.12 gives an example that creates four trees: a default tree using the no-arg constructor, a tree created from an array of objects, a tree created from a vector, and a tree created from a hash table, as shown in Figure 40.21. Enable the user to dynamically set the properties for `rootVisible`, `rowHeight`, and `showsRootHandles`.

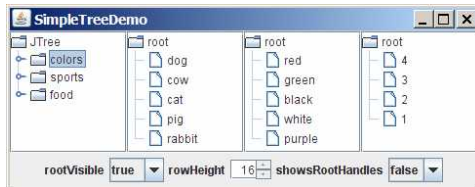


Figure 40.21

You can dynamically set the properties for `rootVisible`, `rowHeight`, and `showRootHandles` in a tree.

Listing 40.12 `SimpleTreeDemo.java`

<margin note line 9: tree 1>  
 <margin note line 12: tree 2>  
 <margin note line 16: tree 3>  
 <margin note line 22: tree 4>  
 <margin note line 43: tree>  
 <margin note line 63: combo box listener>  
 <margin note line 86: spinner listener>  
 <margin note line 97: main method omitted>

```

1 import java.awt.*;
2 import java.awt.event.*;
3 import javax.swing.*;
4 import javax.swing.event.*;
5 import java.util.*;
6
7 public class SimpleTreeDemo extends JApplet {
8 // Create a default tree
9 private JTree jTree1 = new JTree();
10
11 // Create a tree with an array of Objects.
12 private JTree jTree2 = new JTree(new String[]
13 {"dog", "cow", "cat", "pig", "rabbit"});
14
15 // Create a tree with a Hashtable
16 private Vector<Object> vector = new Vector<Object>(Arrays.asList(
17 new Object[]{"red", "green", "black", "white", "purple"}));
18 private JTree jTree3 = new JTree(vector);
19
20 private Hashtable<Integer, String> hashtable =
21 new Hashtable<Integer, String>();
22 private JTree jTree4;
23
24 // Create a combo box for selecting rootVisible
25 private JComboBox jcboRootVisible = new JComboBox(
26 new String[]{"false", "true"});
27
28 // Create a combo box for selecting showRootHandles

```

```

29 private JComboBox jcboShowsRootHandles = new JComboBox(
30 new String[] {"false", "true"});
31
32 // Create a spinner for selecting row height
33 private JSpinner jSpinnerRowHeight = new JSpinner(
34 new SpinnerNumberModel(16, 1, 50, 1));
35
36 public SimpleTreeDemo() {
37 jTree1.setRootVisible(false);
38
39 hashtable.put(1, "red");
40 hashtable.put(2, "green");
41 hashtable.put(3, "blue");
42 hashtable.put(4, "yellow");
43 jTree4 = new JTree(hashtable);
44
45 JPanel panel1 = new JPanel(new GridLayout(1, 4));
46 panel1.add(new JScrollPane(jTree1));
47 panel1.add(new JScrollPane(jTree2));
48 panel1.add(new JScrollPane(jTree3));
49 panel1.add(new JScrollPane(jTree4));
50
51 JPanel panel2 = new JPanel();
52 panel2.add(new JLabel("rootVisible"));
53 panel2.add(jcboRootVisible);
54 panel2.add(new JLabel("rowHeight"));
55 panel2.add(jSpinnerRowHeight);
56 panel2.add(new JLabel("showsRootHandles"));
57 panel2.add(jcboShowsRootHandles);
58
59 add(panel1, BorderLayout.CENTER);
60 add(panel2, BorderLayout.SOUTH);
61
62 // Register listeners
63 jcboRootVisible.addActionListener(new ActionListener() {
64 public void actionPerformed(ActionEvent e) {
65 boolean rootVisible =
66 jcboRootVisible.getSelectedItem().equals("true");
67 jTree1.setRootVisible(rootVisible);
68 jTree2.setRootVisible(rootVisible);
69 jTree3.setRootVisible(rootVisible);
70 jTree4.setRootVisible(rootVisible);
71 }
72 });
73
74 jcboShowsRootHandles.addActionListener(new ActionListener() {
75 @Override
76 public void actionPerformed(ActionEvent e) {
77 boolean showsRootHandles =
78 jcboShowsRootHandles.getSelectedItem().equals("true");
79 jTree1.setShowsRootHandles(showsRootHandles);
80 jTree2.setShowsRootHandles(showsRootHandles);
81 jTree3.setShowsRootHandles(showsRootHandles);
82 jTree4.setShowsRootHandles(showsRootHandles);
83 }
84 });
85
86 jSpinnerRowHeight.addChangeListener(new ChangeListener() {
87 public void stateChanged(ChangeEvent e) {
88 int height =
89 ((Integer)(jSpinnerRowHeight.getValue())).intValue();
90 jTree1.setRowHeight(height);
91 jTree2.setRowHeight(height);
92 jTree3.setRowHeight(height);
93 jTree4.setRowHeight(height);
94 }

```

```
95 });
96 }
97 }
```

Four trees are created in this example. The first is created using the no-arg constructor (line 9) with a default sample tree. The second is created using an array of objects (lines 12-13). All the objects in the array become the children of the root. The third is created using a vector (lines 16-18). All the elements in the vector become the children of the root. The fourth is created using a hash table (lines 39-43). A Hashtable is like a Map. Hashtable was introduced earlier than Java 2 and has since been replaced by Map. It is used in the Java API (e.g., JTree), which was developed before Java 2. The keys of the hash table become the children of the root.

JTree doesn't directly support scrolling. To create a scrollable tree, create a JScrollPane and add an instance of JTree to the scroll pane (lines 46-49).

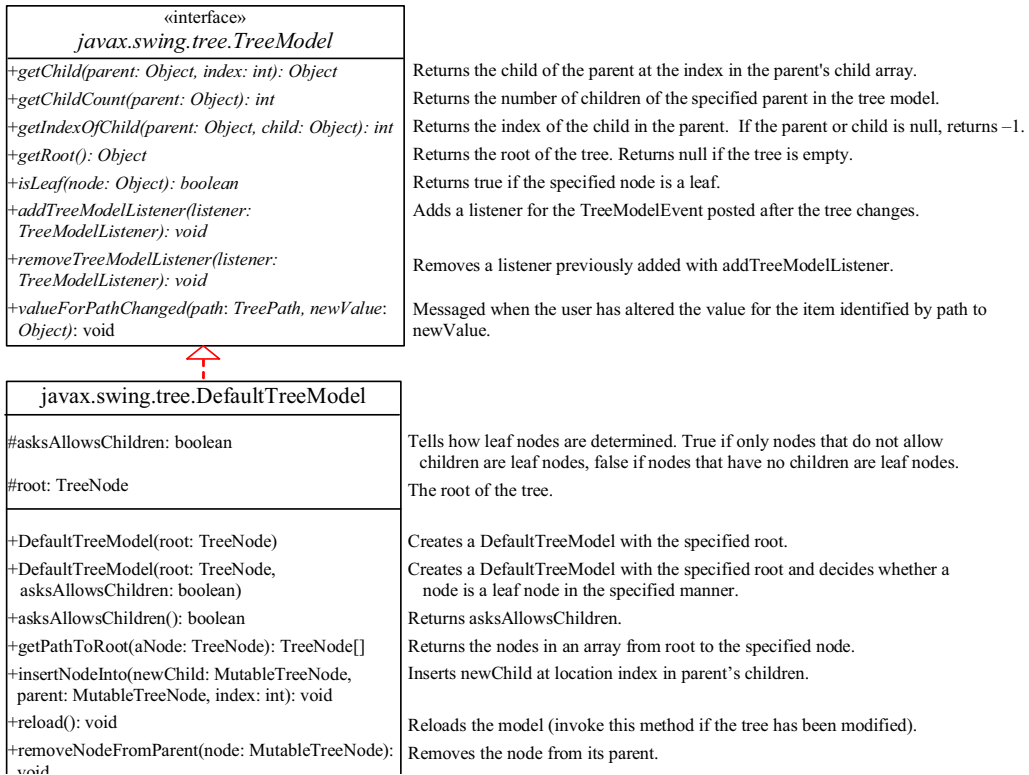
The example enables you to specify whether the root is visible and whether the root handles are visible from two combo boxes (lines 63-83). It also lets you specify the row height of the node in a spinner (lines 85-94).

#### **40.10 TreeModel and DefaultTreeModel**

The TreeModel interface represents the entire tree. Unlike ListModel or TableModel, TreeModel does not directly store or manage tree data. TreeModel contains the structural information about the tree, and tree data are stored and managed by TreeNode.

DefaultTreeModel is a concrete implementation for TreeModel that uses TreeNodes. Figure 40.22 shows TreeModel and DefaultTreeModel.





**Figure 40.22**

*TreeModel* represents an entire tree and *DefaultTreeModel* is a concrete implementation of it.

Once a tree is created, you can obtain its tree model using the `getModel` method. Listing 40.13 gives an example that traverses all the nodes in a tree using the tree model. Line 1 creates a tree using `JTree`'s no-arg constructor with the default sample nodes, as shown in Figure 40.18. The tree model for the tree is obtained in line 4. Line 5 invokes the `traversal` method to traverse the nodes in the tree.

**Listing 40.13 TestTreeModel.java**

```

<margin note line 3: default tree>
<margin note line 4: tree model>
<margin note line 5: getRoot>
<margin note line 11: is leaf?>
<margin note line 12: getChildCount>
<margin note line 13: getChild>

1 public class TestTreeModel {
2 public static void main(String[] args) {
3 javax.swing.JTree jTree1 = new javax.swing.JTree();

```

```

4 javax.swing.tree.TreeModel model = jTree1.getModel();
5 traversal(model, model.getRoot());
6 }
7
8 private static void traversal
9 (javax.swing.tree.TreeModel model, Object root) {
10 System.out.print(root + " ");
11 if (model.isLeaf(root)) return;
12 for (int i = 0; i < model.getChildCount(root); i++) {
13 traversal(model, model.getChild(root, i));
14 }
15 }
16 }

```

<Output>

JTree colors blue violet red yellow sports basketball soccer  
 football hockey food hot dogs pizza ravioli bananas

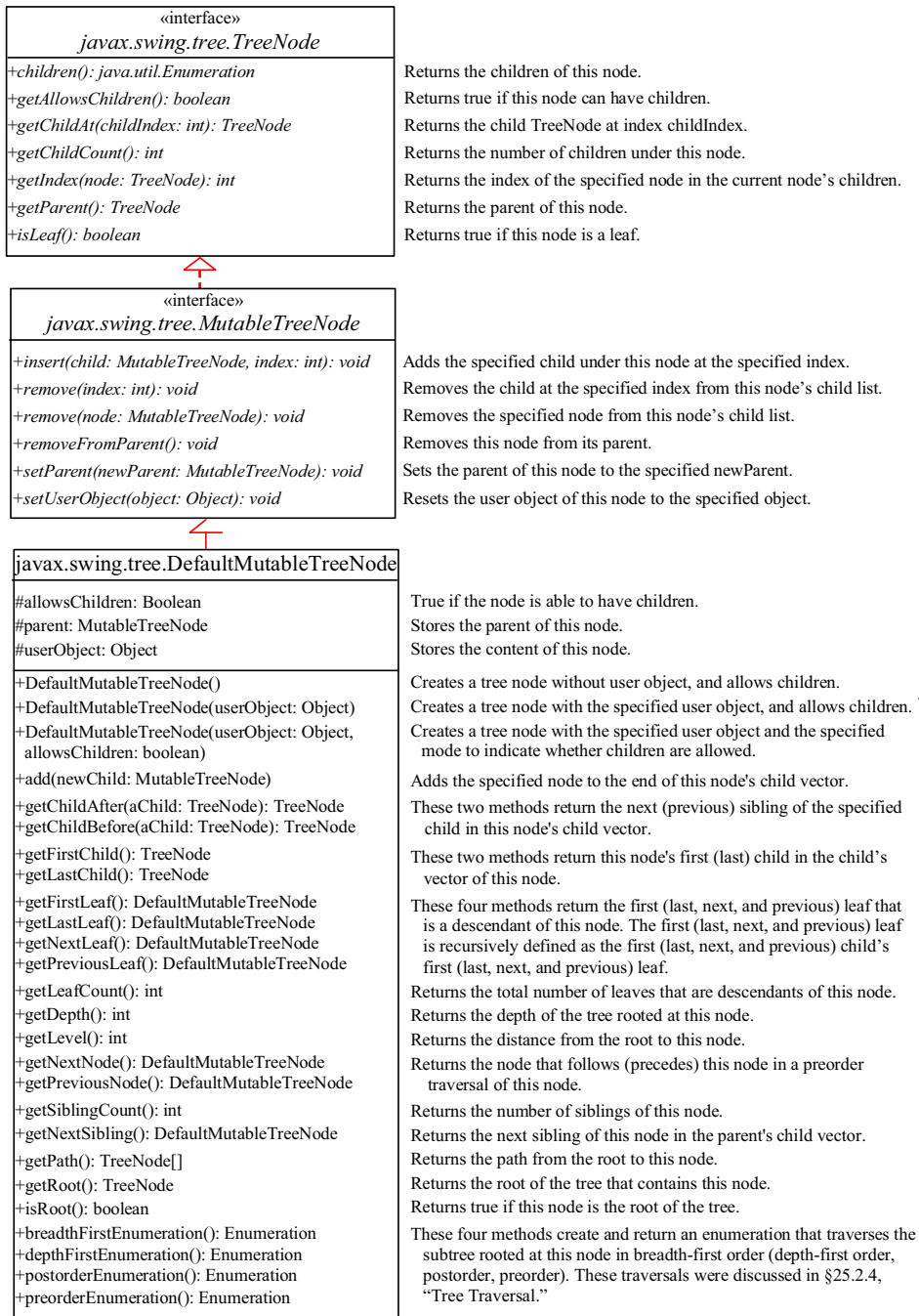
<End Output>

The traversal method starts from the root of the tree. The root is obtained by invoking the getRoot method (line 5). If the root is a leaf, the method returns (line 11). Otherwise, it recursively invokes the traversal method to start from the children of the root (line 13).

#### 40.11 *TreeNode, MutableTreeNode, and DefaultMutableTreeNode*

While TreeModel represents the entire tree, TreeNode stores a single node of the tree. MutableTreeNode defines a subinterface of TreeNode with additional methods for changing the content of the node, for inserting and removing a child node, for setting a new parent, and for removing the node itself.

DefaultMutableTreeNode is a concrete implementation of MutableTreeNode that maintains a list of children in a vector and provides the operations for creating nodes, for examining and modifying a node's parent and children, and also for examining the tree to which the node belongs. Normally, you should use DefaultMutableTreeNode to create a tree node. Figure 40.23 shows TreeNode, MutableTreeNode, and DefaultMutableTreeNode.



**Figure 40.23**

*TreeNode* represents a node.

NOTE

**<margin note: depth-first traversal>**

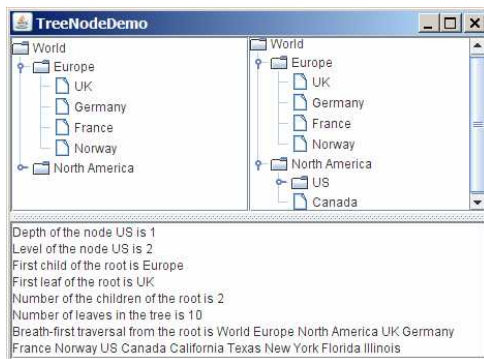
In graph theory, depth-first traversal is defined the same as preorder traversal, but in the `depthFirstEnumeration()` method in `DefaultMutableTreeNode`, it is the same as postorder traversal.

NOTE

**<margin note: creating trees>**

You can create a `JTree` from a root using `new JTree(TreeNode)` or from a model using `new JTree(TreeModel)`. To create a tree model, you first create an instance of `TreeNode` to represent the root of the tree, and then create an instance of `DefaultTreeModel` fitted with the root.

Listing 40.14 gives an example that creates two trees to display world, continents, countries, and states. The two trees share the same nodes and thus display identical contents. The program also displays the properties of the tree in a text area, as shown in Figure 40.24.



**Figure 40.24**

The two trees have the same data because their roots are the same.

**Listing 40.14** `TreeNodeDemo.java`

**<margin note line 9: tree nodes>**

**<margin note line 12: add children>**

**<margin note line 19: add children>**

**<margin note line 62: main method omitted>**

```
1 import java.awt.*;
2 import javax.swing.*;
3 import javax.swing.tree.*;
4 import java.util.*;
5
6 public class TreeNodeDemo extends JApplet {
7 public TreeNodeDemo() {
8 // Create the first tree
9 DefaultMutableTreeNode root, europe, northAmerica, us;
10
11 europe = new DefaultMutableTreeNode("Europe");
12 europe.add(new DefaultMutableTreeNode("UK"));
13 europe.add(new DefaultMutableTreeNode("Germany"));
```

```

14 europe.add(new DefaultMutableTreeNode("France"));
15 europe.add(new DefaultMutableTreeNode("Norway"));
16
17 northAmerica = new DefaultMutableTreeNode("North America");
18 us = new DefaultMutableTreeNode("US");
19 us.add(new DefaultMutableTreeNode("California"));
20 us.add(new DefaultMutableTreeNode("Texas"));
21 us.add(new DefaultMutableTreeNode("New York"));
22 us.add(new DefaultMutableTreeNode("Florida"));
23 us.add(new DefaultMutableTreeNode("Illinois"));
24 northAmerica.add(us);
25 northAmerica.add(new DefaultMutableTreeNode("Canada"));
26
27 root = new DefaultMutableTreeNode("World");
28 root.add(europe);
29 root.add(northAmerica);
30
31 JPanel panel = new JPanel();
32 panel.setLayout(new GridLayout(1, 2));
33 panel.add(new JScrollPane(new JTree(root)));
34 panel.add(new JScrollPane(new JTree(new DefaultTreeModel(root))));
35
36 JTextArea jtaMessage = new JTextArea();
37 jtaMessage.setWrapStyleWord(true);
38 jtaMessage.setLineWrap(true);
39 add(new JSplitPane(JSplitPane.VERTICAL_SPLIT,
40 panel, new JScrollPane(jtaMessage)), BorderLayout.CENTER);
41
42 // Get tree information
43 jtaMessage.append("Depth of the node US is " + us.getDepth());
44 jtaMessage.append("\nLevel of the node US is " + us.getLevel());
45 jtaMessage.append("\nFirst child of the root is " +
46 root.getFirstChild());
47 jtaMessage.append("\nFirst leaf of the root is " +
48 root.getFirstLeaf());
49 jtaMessage.append("\nNumber of the children of the root is " +
50 root.getChildCount());
51 jtaMessage.append("\nNumber of leaves in the tree is " +
52 root.getLeafCount());
53 String breadthFirstSearchResult = "";
54
55 // Breadth-first traversal
56 Enumeration bf = root.breadthFirstEnumeration();
57 while (bf.hasMoreElements())
58 breadthFirstSearchResult += bf.nextElement().toString() + " ";
59 jtaMessage.append("\nBreadth-first traversal from the root is "
60 + breadthFirstSearchResult);
61 }
62 }

```

You can create a `JTree` using a `TreeNode` root (line 33) or a `TreeModel` (line 34), whichever is convenient. A `TreeModel` is actually created using a `TreeNode` root (line 34). The two trees have the same contents because the root is the same. However, it is important to note that the two `JTree` objects are different, and so are their `TreeModel` objects, although both trees have the same root.

A tree is created by adding the nodes to the tree (lines 9-29). Each node is created using the `DefaultMutableTreeNode` class. This class provides many methods to manipulate the tree (e.g., adding a child, removing a child) and obtaining information about the tree (e.g., level, depth, number of children, number of leaves,

traversals). Some examples of using these methods are given in lines 43-60.

As shown in this example, often you don't have to directly use `TreeModel`. Using `DefaultMutableTreeNode` is sufficient, since the tree data are stored in `DefaultMutableTreeNode`, and `DefaultMutableTreeNode` contains all the methods for modifying the tree and obtaining tree information.

#### 40.12 TreePath and TreeSelectionModel

The `JTree` class contains the methods for selecting tree paths. The `TreePath` class represents a path from an ancestor to a descendant in a tree. Figure 40.25 shows `TreePath`.

javax.swing.tree.TreePath	
+TreePath(singlePath: Object)	Constructs a TreePath containing only a single element.
+TreePath(path: Object[])	Constructs a path from an array of objects.
+getLastPathComponent(): Object	Returns the last component of this path.
+getParentPath(): TreePath	Returns a path containing all but the last path component.
+getPath(): Object[]	Returns an ordered array of objects containing the components of this TreePath.
+getPathComponent(element: int): Object	Returns the path component at the specified index.
+getPathCount(): int	Returns the number of elements in the path.
+isDescendant(aTreePath: TreePath): boolean	Returns true if aTreePath contains all the components in this TreePath.
+pathByAddingChild(child: Object): TreePath	Returns a new path containing all the elements of this TreePath plus child.

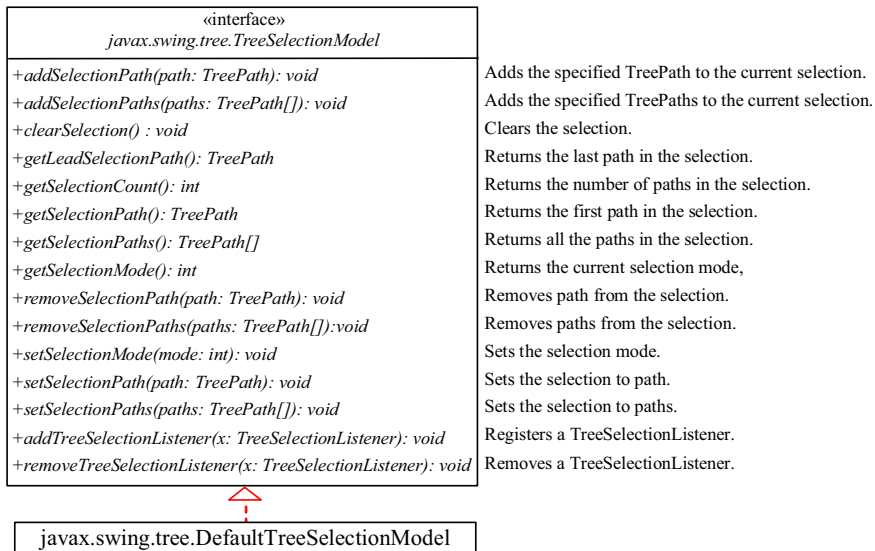
**Figure 40.25**

*TreePath* represents a path from an ancestor to a descendant in a tree.

**<margin note: obtain tree paths>**

You can construct a `TreePath` from a single object or an array of objects, but often instances of `TreePath` are returned from the methods in `JTree` and `TreeSelectionModel`. For instance, the `getLeadSelectionPath()` method in `JTree` returns the path from the root to the selected node. There are many ways to extract the nodes from a tree path. Often you use the `getLastPathComponent()` method to obtain the last node in the path, and then the `getParent()` method to get all the nodes in the path upward through the link.

The selection of tree nodes is defined in the `TreeSelectionModel` interface, as shown in Figure 40.26. The `DefaultTreeSelectionModel` class is a concrete implementation of the `TreeSelectionModel` that maintains an array of `TreePath` objects representing the current selection. The last `TreePath` selected, called the *lead path*, can be obtained using the `getLeadSelectionPath()` method. To obtain all the selection paths, use the `getSelectionPaths()` method, which returns an array of tree paths.



**Figure 40.26**

The `TreeSelectionModel` handles selection in a tree and `DefaultTreeSelectionModel` is a concrete implementation of it.

**<margin note: tree selection modes>**

`TreeSelectionModel` supports three selection modes: contiguous selection, discontinuous selection, and single selection. *Single selection* allows only one item to be selected. *Contiguous selection* allows multiple selections, but the selected items must be contiguous. *Discontiguous selection* is the most flexible; it allows any item to be selected at a given time. The default tree selection mode is discontinuous. To set a selection mode, use the `setSelectionMode(int mode)` method in `TreeSelectionModel`. The constants for the three modes are:

- `CONTIGUOUS_TREE_SELECTION`
- `DISCONTIGUOUS_TREE_SELECTION`
- `SINGLE_TREE_SELECTION`

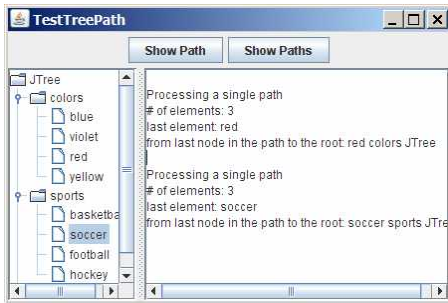
NOTE

**<margin note: bypass `TreeSelectionModel`>**

When you create a `JTree`, a `DefaultTreeSelectionModel` is automatically created, and thus you rarely need to create an instance of `TreeSelectionModel` explicitly. Since most of the methods in `TreeSelectionModel` are also in `JTree`, you can get selection paths and process the selection without directly dealing with `TreeSelectionModel`.

Listing 40.15 gives an example that displays a selected path or selected paths in tree. The user may select a node or multiple nodes and click the *Show Path* button to display the properties of the first selected path or the *Show Paths* button to display all

the selected paths in a text area, as shown in Figure 40.27. The *Show Path* button displays a path from the last node up to the root.



**Figure 40.27**

The selected path(s) are processed.

**Listing 40.15** TestTreePath.java

<margin note line 7: default tree>  
 <margin note line 8: text area>  
 <margin note line 9: Show Path button>  
 <margin note line 10: Show Paths button>  
 <margin note line 13: split pane>  
 <margin note line 23: Show Path button>  
 <margin note line 26: selected path>  
 <margin note line 28: path count>  
 <margin note line 32: last node>  
 <margin note line 35: get parent>  
 <margin note line 39: Show Paths button>  
 <margin note line 43: selected paths>  
 <margin note line 44: display a path>  
 <margin note line 48: main method omitted>

```

1 import java.awt.*;
2 import java.awt.event.*;
3 import javax.swing.*;
4 import javax.swing.tree.*;
5
6 public class TestTreePath extends JApplet {
7 private JTree jTree = new JTree();
8 private JTextArea jtaOutput = new JTextArea();
9 private JButton jbtShowPath = new JButton("Show Path");
10 private JButton jbtShowPaths = new JButton("Show Paths");
11
12 public TestTreePath() {
13 JSplitPane splitPane = new JSplitPane(JSplitPane.HORIZONTAL_SPLIT,
14 new JScrollPane(jTree), new JScrollPane(jtaOutput));
15
16 JPanel panel = new JPanel();
17 panel.add(jbtShowPath);
18 panel.add(jbtShowPaths);
19
20 add(splitPane, BorderLayout.CENTER);
21 add(panel, BorderLayout.NORTH);
22
23 jbtShowPath.addActionListener(new ActionListener() {
24 @Override
25 public void actionPerformed(ActionEvent e) {
26 TreePath path = jTree.getSelectionPath();

```



```

27 jtaOutput.append("\nProcessing a single path\n");
28 jtaOutput.append("# of elements: " + path.getPathCount());
29 jtaOutput.append("\nlast element: "
30 + path.getLastPathComponent());
31 jtaOutput.append("\nfrom last node in the path to the root: ");
32 TreeNode node = (TreeNode)path.getLastPathComponent();
33 while (node != null) {
34 jtaOutput.append(node.toString() + " ");
35 node = node.getParent();
36 }
37 });
38
39 jbtShowPaths.addActionListener(new ActionListener() {
40 @Override
41 public void actionPerformed(ActionEvent e) {
42 jtaOutput.append("\nProcessing multiple paths\n");
43 javax.swing.tree.TreePath[] paths = jTree.getSelectionPaths();
44 for (int i = 0; i < paths.length; i++)
45 jtaOutput.append(paths[i].toString() + "\n");
46 }
47 });
48 }

```

The `getSelectionPath()` method invoked from a `JTree` returns a `TreePath` in line 25. The first node in the path is always the root of the tree. The `getPathCount()` invoked from a `TreePath` returns the number of the nodes in the path (line 27). The `getLastPathComponent()` invoked from a `TreePath` returns the last node in the path (line 29). The return node type is `Object`. You need to cast it to a `TreeNode` (line 31) in order to invoke the `getParent()` method from a `TreeNode` (line 34).

While the `getSelectionPath()` method (line 25) returns the first selected path, the `getSelectionPaths()` method (line 41) returns all the selected paths in an array of paths.

### 40.13 Case Study: Modifying Trees

Write a program to create two trees that display the same contents: world, continents, countries, and states, as shown in Figure 40.28. For the tree on the left, enable the user to choose a selection mode, specify whether it can be edited, add a new child under the first selected node, and remove all the selected nodes.

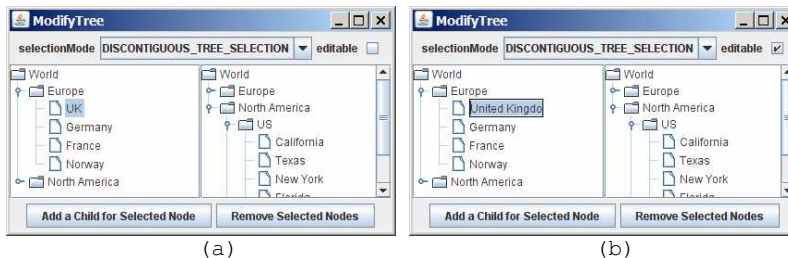


Figure 40.28

You can rename a node, add a child, and remove nodes in a tree dynamically.

You can choose a selection mode from the selectionMode combo box. You can specify whether the left tree nodes can be edited from the editable check box.

When you click a button, if no nodes are currently selected in the left tree, a message dialog box is displayed, as shown in Figure 40.29a. When you click the *Add a Child for Selected Node* button, an input dialog box is displayed to prompt the user to enter a child name for the selected node, as shown in Figure 40.29b. The new node becomes a child of the first selected node. When you click the *Remove Selected Nodes* button, all the selected nodes in the left tree are removed.



**Figure 40.29**

You can add a new node to the tree.

Listing 40.16 gives the program.

**Listing 40.16 ModifyTree.java**

```

<margin note line 8: combo box>
<margin note line 13: check box>
<margin note line 16: buttons>
<margin note line 21: trees>
<margin note line 25: tree nodes>
<margin note line 27: fill nodes>
<margin note line 56: create jTree1>
<margin note line 57: create jTree2>
<margin note line 69: choose selection mode>
<margin note line 74: set selection mode>
<margin note line 86: choose editable>
<margin note line 89: set editable>
<margin note line 93: add child>
<margin note line 96: get selected node>
<margin note line 111: add new node>
<margin note line 114: reload tree model>
<margin note line 119: remove node>
<margin note line 122: get selected paths>
<margin note line 140: remove node>
<margin note line 144: reload tree model>
<margin note line 149: main method omitted>

1 import java.awt.*;
2 import java.awt.event.*;
3 import javax.swing.*;
4 import javax.swing.tree.*;
5
6 public class ModifyTree extends JApplet {
7 // Create a combo box for choosing selection modes
8 private JComboBox jcboSelectionMode = new JComboBox(new String[]{
9 "CONTIGUOUS_TREE_SELECTION", "DISCONTIGUOUS_TREE_SELECTION",
10 "SINGLE_TREE_SELECTION"});
11
12 // Create a check box for specifying editable

```

```

13 private JCheckBox jchkEditable = new JCheckBox();
14
15 // Create two buttons
16 private JButton jbtAdd =
17 new JButton("Add a Child for Selected Node");
18 private JButton jbtRemove = new JButton("Remove Selected Nodes");
19
20 // Declare two trees
21 private JTree jTree1, jTree2;
22
23 public ModifyTree() {
24 // Create the first tree
25 DefaultMutableTreeNode root, europe, northAmerica, us;
26
27 europe = new DefaultMutableTreeNode("Europe");
28 europe.add(new DefaultMutableTreeNode("UK"));
29 europe.add(new DefaultMutableTreeNode("Germany"));
30 europe.add(new DefaultMutableTreeNode("France"));
31 europe.add(new DefaultMutableTreeNode("Norway"));
32
33 northAmerica = new DefaultMutableTreeNode("North America");
34 us = new DefaultMutableTreeNode("US");
35 us.add(new DefaultMutableTreeNode("California"));
36 us.add(new DefaultMutableTreeNode("Texas"));
37 us.add(new DefaultMutableTreeNode("New York"));
38 us.add(new DefaultMutableTreeNode("Florida"));
39 us.add(new DefaultMutableTreeNode("Illinois"));
40 northAmerica.add(us);
41 northAmerica.add(new DefaultMutableTreeNode("Canada"));
42
43 root = new DefaultMutableTreeNode("World");
44 root.add(europe);
45 root.add(northAmerica);
46
47 jcboSelectionMode.setSelectedIndex(1);
48
49 JPanel p1 = new JPanel();
50 p1.add(new JLabel("selectionMode"));
51 p1.add(jcboSelectionMode);
52 p1.add(new JLabel("editable"));
53 p1.add(jchkEditable);
54
55 JPanel p2 = new JPanel(new GridLayout(1, 2));
56 p2.add(new JScrollPane(jTree1 = new JTree(root)));
57 p2.add(new JScrollPane(jTree2 =
58 new JTree(new DefaultTreeModel(root)))); // Same root as jTree1
59
60 JPanel p3 = new JPanel();
61 p3.add(jbtAdd);
62 p3.add(jbtRemove);
63
64 add(p1, BorderLayout.NORTH);
65 add(p2, BorderLayout.CENTER);
66 add(p3, BorderLayout.SOUTH);
67
68 // Register listeners
69 jcboSelectionMode.addActionListener(new ActionListener() {
70 @Override
71 public void actionPerformed(ActionEvent e) {
72 if (jcboSelectionMode.getSelectedItem().
73 equals("CONTIGUOUS_TREE_SELECTION"))
74 jTree1.getSelectionModel().setSelectionMode(
75 TreeSelectionMode.CONTIGUOUS_TREE_SELECTION);
76 else if (jcboSelectionMode.getSelectedItem().
77 equals("DISCONTIGUOUS_TREE_SELECTION"))
78 jTree1.getSelectionModel().setSelectionMode(

```

```

79 TreeSelectionModel.DISCONTIGUOUS_TREE_SELECTION);
80 else
81 jTree1.getSelectionModel().setSelectionMode(
82 TreeSelectionModel.SINGLE_TREE_SELECTION);
83 }
84 }});
85
86 jchkEditable.addActionListener(new ActionListener() {
87 @Override
88 public void actionPerformed(ActionEvent e) {
89 jTree1.setEditable(jchkEditable.isSelected());
90 }
91 }});
92
93 jbtAdd.addActionListener(new ActionListener() {
94 @Override
95 public void actionPerformed(ActionEvent e) {
96 DefaultMutableTreeNode parent = (DefaultMutableTreeNode)
97 jTree1.getLastSelectedPathComponent();
98
99 if (parent == null) {
100 JOptionPane.showMessageDialog(null,
101 "No node in the left tree is selected");
102 return;
103 }
104
105 // Enter a new node
106 String nodeName = JOptionPane.showInputDialog(
107 null, "Enter a child node for " + parent, "Add a Child",
108 JOptionPane.QUESTION_MESSAGE);
109
110 // Insert the new node as a child of treeNode
111 parent.add(new DefaultMutableTreeNode(nodeName));
112
113 // Reload the model since a new tree node is added
114 ((DefaultTreeModel) (jTree1.getModel())).reload();
115 ((DefaultTreeModel) (jTree2.getModel())).reload();
116 }
117 }});
118
119 jbtRemove.addActionListener(new ActionListener() {
120 public void actionPerformed(ActionEvent e) {
121 // Get all selected paths
122 TreePath[] paths = jTree1.getSelectionPaths();
123
124 if (paths == null) {
125 JOptionPane.showMessageDialog(null,
126 "No node in the left tree is selected");
127 return;
128 }
129
130 // Remove all selected nodes
131 for (int i = 0; i < paths.length; i++) {
132 DefaultMutableTreeNode node = (DefaultMutableTreeNode)
133 (paths[i].getLastPathComponent());
134
135 if (node.isRoot()) {
136 JOptionPane.showMessageDialog(null,
137 "Cannot remove the root");
138 }
139 else
140 node.removeFromParent();
141 }
142
143 // Reload the model since a new tree node is added
144 ((DefaultTreeModel) (jTree1.getModel())).reload();

```

```

145 ((DefaultTreeModel) (jTree2.getModel())).reload();
146 }
147 });
148 }
149 }

```

Two `JTree` objects (`jTree1` and `jTree2`) are created with the same root (lines 56-58), but each has its own `TreeSelectionModel`. When you choose a selection mode in the combo box, the new selection mode is set in `jTree1`'s selection model (line 69-83). The selection mode for `jTree2` is not affected.

When the editable check box is checked or unchecked, the `editable` property in `jTree1` is set accordingly. If `editable` is true, you can edit a node in the left tree.

When you click the *Add a Child for Selected Node* button, the first selected node is returned as `parent` (lines 93-94). Suppose you selected Europe, UK, and US in this order; `parent` is Europe. If `parent` is null, no node is selected in the left tree (lines 96-100). Otherwise, prompt the user to enter a new node from an input dialog box (lines 103-105) and add this node as a child of `parent` (line 108). Since the tree has been modified, you need to invoke the `reload()` method to notify that the models for both trees have been changed (lines 111-112). Otherwise, the new node may not be displayed in `jTree1` and `jTree2`.

When you click the *Remove Selected Nodes* button, all the tree paths for each selected node are obtained in `paths` (line 119). Suppose you selected Europe, UK, and US in this order; three tree paths are obtained. Each path starts from the root to a selected node. If no node is selected, `paths` is null. To delete a selected node is to delete the last node in each selected tree path (128-138). The last node in a path is obtained using `getLastPathComponent()`. If the node is the root, it cannot be removed (lines 132-135). The `removeFromParent()` method removes a node (line 137).

#### 40.14 Tree Node Rendering and Editing

`JTree` delegates node rendering to a renderer. All renderers are instances of the `TreeCellRenderer` interface, which defines a single method, `getTreeCellRendererComponent`, as follows:

```

public Component getTreeCellRendererComponent
(JTree tree, Object value, boolean selected, boolean expanded,
boolean leaf, int row, boolean hasFocus);

```

You can create a custom tree cell renderer by implementing the `TreeCellRenderer` interface, or use the `DefaultTreeCellRenderer` class, which provides a default implementation for `TreeCellRenderer`. When a new `JTree` is created, an instance of `DefaultTreeCellRenderer` is assigned to the tree renderer. The `DefaultTreeCellRenderer` class maintains three icon properties named `leafIcon`, `openIcon`, and `closedIcon` for leaf nodes, expanded nodes, and collapsed nodes. It also provides colors for text and background. The following code sets new leaf, open and closed icons, and new background selection color in the tree:

```

DefaultTreeCellRenderer renderer =

```

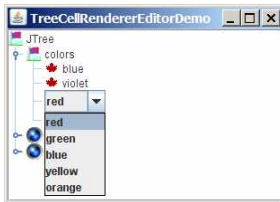
```
(DefaultTreeCellRendererer)jTree1.getCellRendererer();
rendererer.setLeafIcon(yourCustomLeafImageIcon);
rendererer.setOpenIcon(yourCustomOpenImageIcon);
rendererer.setClosedIcon(yourCustomClosedImageIcon);
rendererer.setBackgroundSelectionColor(Color.red);
```

NOTE: The default leaf, open icon, and closed icon are dependent on the look-and-feel. For instance, on Windows look-and-feel, the open icon is - and the closed icon is +.

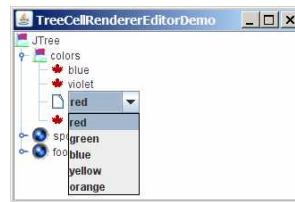
JTree comes with a default cell editor. If JTree's `editable` property is `true`, the default editor activates a text field for editing when the node is clicked three times. By default, this property is set to `false`. To create a custom editor, you need to extend the `DefaultCellEditor` class, which is the same class you used in table cell editing. You can use a text field, a check box, or a combo box, and pass it to `DefaultCellEditor`'s constructor to create an editor. The following code uses a combo box for editing colors. The combo box editor is shown in Figure 40.30a.

```
// Customize editor
JComboBox jcboColor = new JComboBox();
jcboColor.addItem("red");
jcboColor.addItem("green");
jcboColor.addItem("blue");
jcboColor.addItem("yellow");
jcboColor.addItem("orange");

jTree1.setCellEditor(new javax.swing.DefaultCellEditor(jcboColor));
jTree1.setEditable(true);
```



(a)



(b)

**Figure 40.30**

*You can supply a custom editor for editing tree nodes.*

There are two annoying problems with the editor created in the preceding code. First, it is activated with just one mouse click. Second, it overlaps the node's icon, as shown in Figure 40.30a. These two problems can be fixed by using the `DefaultTreeCellEditor`, as shown in the following code:

```
jTree1.setCellEditor
(new javax.swing.tree.DefaultTreeCellEditor(jTree1,
new javax.swing.tree.DefaultTreeCellRendererer(),
new javax.swing.DefaultCellEditor(jcboColor)));
```

The new editor is shown in Figure 40.30b. Editing using `DefaultTreeCellEditor` starts on a triple mouse click. The combo box does not overlap the node's icon.

## 40.15 Tree Events

JTree can fire TreeSelectionEvent and TreeExpansionEvent, among many other events. Whenever a new node is selected, JTree fires a TreeSelectionEvent. Whenever a node is expanded or collapsed, JTree fires a TreeExpansionEvent. To handle the tree-selection event, a listener must implement the TreeSelectionListener interface, which contains a single handler named valueChanged method. TreeExpansionListener contains two handlers named treeCollapsed and treeExpanded for handling node expansion or node closing.

The following code displays a selected node in a listener class for TreeSelectionEvent:

```
public void valueChanged(TreeSelectionEvent e) {
 TreePath path = e.getNewLeadSelectionPath();
 TreeNode treeNode = (TreeNode)path.getLastPathComponent();
 System.out.println("The selected node is " + treeNode.toString());
}
```

## Chapter Summary

1. JTable has three supporting models: a table model, a column model, and a list-selection model. The *table model* is for storing and processing data. The *column model* represents all the columns in the table. The *list-selection model* is the same as the one used by JList for selecting rows, columns, and cells in a table. JTable also has two useful supporting classes, TableColumn and JTableHeader. TableColumn contains the information on a particular column. JTableHeader can be used to display the header of a JTable. Each column has a default editor and renderer. You can also create a custom editor by implementing the TableCellEditor interface, and you can create a custom renderer by implementing the TableCellRenderer interface.
2. Like JTable, JTree is a very complex component with many supporting interfaces and classes. While JTree displays the tree, the data representation of the tree is handled by TreeModel, TreeNode, and TreePath. TreeModel represents the entire tree, TreeNode represents a node, and TreePath represents a path to a node. Unlike the ListModel or TableModel, the tree model does not directly store or manage tree data. Tree data are stored and managed in TreeNode and TreePath. A TreePath is an array of Objects that are vended from a TreeModel. The elements of the array are ordered such that the root is always the first element (index 0) of the array. The TreeSelectionModel interface handles tree node selection. The DefaultTreeCellRenderer class provides a default tree node renderer that can display a label and/or an icon in a node. The DefaultTreeCellEditor can be used to edit the cells in a text field. The TreePath class is a support class that represents a set of nodes in a path.

3. JTable and JTree are in the `javax.swing` package, but their supporting interfaces and classes are all included in the `javax.swing.table` and `javax.swing.tree` packages, respectively.

## Test Questions

Do the test questions for this chapter online at [www.cs.armstrong.edu/liang/intro9e/test.html](http://www.cs.armstrong.edu/liang/intro9e/test.html).

## Review Questions

### *Sections 40.2-40.7*

40.1 How do you initialize a table? Can you specify the maximum number of visible rows in a table without scrolling? How do you specify the height of a table cell? How do you specify the horizontal margin of table cells?

40.2 How do you modify table contents? How do you add or remove a row? How do you add or remove a column?

40.3 What is autoresizing of a table column? How many types of autoresizing are available?

40.4 What are the properties that show grids, horizontal grids, and vertical grids? What are the properties that specify the table row height, vertical margin, and horizontal margin?

40.5 What are the default table renderers and editors? How do you create a custom table cell renderer and editor?

40.6 What are the default tree renderers and editors? How do you create a custom tree cell renderer and editor?

40.7 How do you disable table cell editing?

### *Sections 40.8-40.14*

40.8 How do you create a tree? How do you specify the row height of a tree node? How do you obtain the default tree model and tree-selection model from an instance of JTree?

40.9 How do you initialize data in a tree using TreeModel? How do you add a child to an instance of DefaultMutableTreeNode?

40.10 How do you enable tree node editing?

40.11 How do you add or remove a node from a tree?

40.12 How do you obtain a selected tree node?

## Programming Exercises

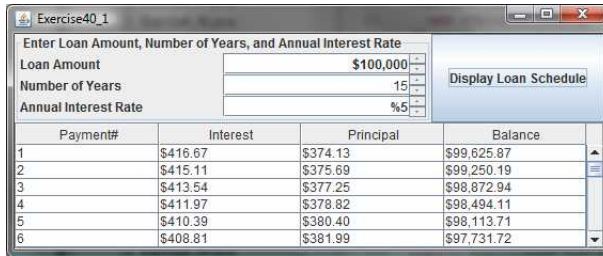
### *Sections 40.2-40.7*

40.1\*

(Create a table for a loan schedule) Exercise 31.5 displays an amortization schedule in a text area. Write a program that



enables the user to enter or choose the loan amount, number of years, and interest rate from spinners and displays the schedule in a table, as shown in Figure 40.31. The step for loan amount is \$500, for number of years is 1, and for annual interest rate is 0.125%.



**Figure 40.31**

The table shows the loan schedule.

40.2\*

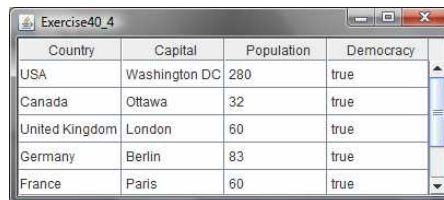
(Delete rows and columns) Listing 40.6, `ModifyTable.java`, allows you to delete only the first selected row or column. Enable the program to delete all the selected rows or columns. Also enable the program to delete a row or a column by pressing the DELETE key.

40.3\*\*

(Create a student table) Create a table for student records. Each record consists of name, birthday, class status, in-state, and a photo, as shown in Figure 40.32a. The name is of the `String` type; birthday is of the `Date` type; class status is one of the following five values: Freshman, Sophomore, Junior, Senior, or Graduate; in-state is a `boolean` value indicating whether the student is a resident of the state; and photo is an image icon. Use the default editors for name, birthday, and in-state. Supply a combo box as custom editor for class status.



(a)



(b)

**Figure 40.32**

(a) The table displays student records. (b) The data in the file are displayed in a `JTable`.

40.4\*

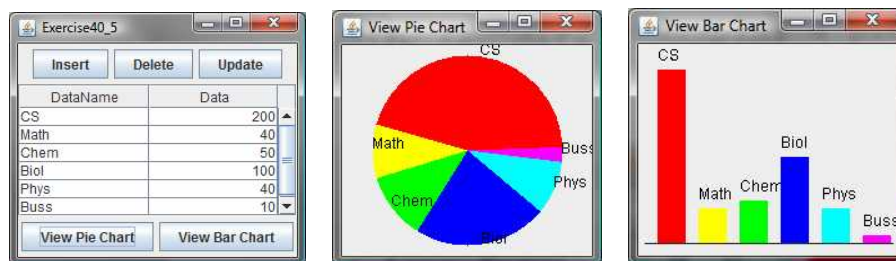
(Display a table for data from a text file) Suppose that a table named Exercise36\_4Table.txt is stored in a text file. The first line in the file is the header, and the remaining lines correspond to rows in the table. The elements are separated by commas. Write a program to display the table using the `JTable` component. For example, the following text file is displayed in a table, as shown in Figure 40.32b.

```
Country, Capital, Population, Democracy
USA, Washington DC, 280, true
Canada, Ottawa, 32, true
United Kingdom, London, 60, true
Germany, Berlin, 83, true
France, Paris, 60, true
Norway, Oslo, 4.5, true
India, New Delhi, 1046, true
```

40.5\*\*\*

(Create a controller using `JTable`) In Exercise 35.1, you created a chart model (`ChartModel`) and two views (`PieChart` and `BarChart`). Create a controller that enables the user to modify the data, as shown in Figure 40.33. You will see the changes take effect in the pie-chart view and the bar-chart view. Your exercise consists of the following classes:

- The controller named `ChartController`. This class uses a table to display data. You can modify the data in the table. Click the *Insert* button to insert a new row above the selected row in the table, click the *Delete* button to delete the selected row in the table, and click the *Update* button to update the changes you made in the table.
- The class `MyTableModel`. This class extends `DefaultTableModel` to override the `getColumnClass` method so that you can use the `JTable`'s default editor for numerical values. This class is same as in Listing 40.7.
- The classes `ChartModel`, `PieChart`, and `BarChart` from Exercise 35.1.
- The main class `Exercise36_5`. This class creates a user interface with a controller and two buttons, *View Pie Chart* and *View Bar Chart*. Click the *View Pie Chart* button to pop up a frame to display a pie chart, and click the *View Bar Chart* button to pop up a frame to display a bar chart.



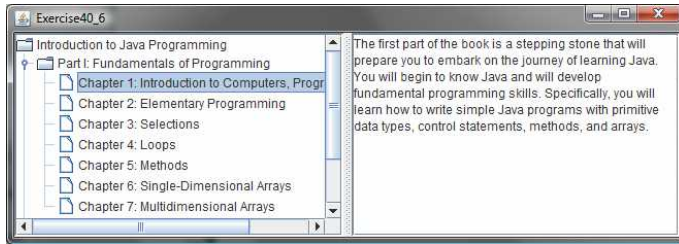
**Figure 40.33**

You can modify the data in the controller. The views are synchronized with the controller.

## Sections 40.8-40.14

### 40.6\*

(Create a tree for book chapters) Create a tree to display the table of contents for a book. When a node is selected in the tree, display a paragraph to describe the selected node, as shown in Figure 40.34.

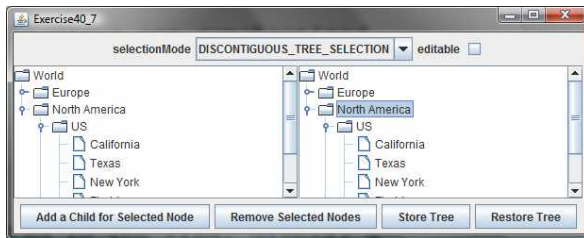


**Figure 40.34**

The content of the node is displayed in a text area when the node is clicked.

### 40.7\*

(Store and restore trees) Modify Listing 40.16, `ModifyTree.java`, to add two buttons, as shown in Figure 40.35 to store and restore trees. Use the object I/O to store the tree model.



**Figure 40.35**

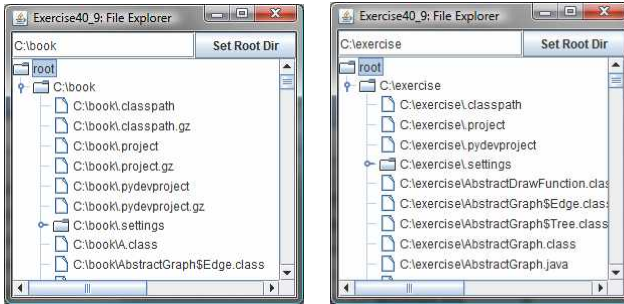
You can store tree data to a file and restore them later.

### 40.8\*

(Traverse trees) Create a tree using the default `JTree` constructor and traverse the nodes in breadth-first, depth-first, preorder, and postorder.

### 40.9\*\*\*

(File explorer) Use `JTree` to develop a file explorer. The program lets the user enter a directory and displays all files under the directory, as shown in Figure 40.36.



**Figure 40.36**

*The file explorer explores the files in a directory.*

40.10\*\*

*(Add and delete tree nodes using the INSERT and DELETE keys) Modify Listing 40.16, ModifyTree.java, to add a new child node by pressing the INSERT key, and delete a node by pressing the DELETE key.*

40.11\*

*(Find tables and show their contents) Revise Programming Exercise 33.6 to display the table contents in a JTable rather than in a text area.*

*\*\*\*This is a bonus Web chapter*

## **CHAPTER 41**

### **Advanced Java Database Programming**

#### Objectives

- To create a universal SQL client for accessing local or remote database (§41.2).
- To execute SQL statements in a batch mode (§41.3).
- To process updatable and scrollable result sets (§41.4).
- To simplify Java database programming using RowSet (§41.5).
- To create a custom table model for RowSet (§41.5).
- To store and retrieve images in JDBC (§41.7).

## 41.1 Introduction

The preceding chapter introduced JDBC's basic features. This chapter covers its advanced features. You will learn how to develop a universal SQL client for accessing any local or remote relational database, learn how to execute statements in a batch mode to improve performance, learn scrollable result sets and how to update a database through result sets, learn how to use `RowSet` to simplify database access, and learn how to store and retrieve images.

## 41.2 A Universal SQL Client

In the preceding chapter, you used various drivers to connect to the database, created statements for executing SQL statements, and processed the results from SQL queries. This section presents a universal SQL client that enables you to connect to any relational database and execute SQL commands interactively, as shown in Figure 41.1. The client can connect to any JDBC data source and can submit SQL SELECT commands and non-SELECT commands for execution. The execution result is displayed for the SELECT queries, and the execution status is displayed for the non-SELECT commands. Listing 41.1 gives the program.

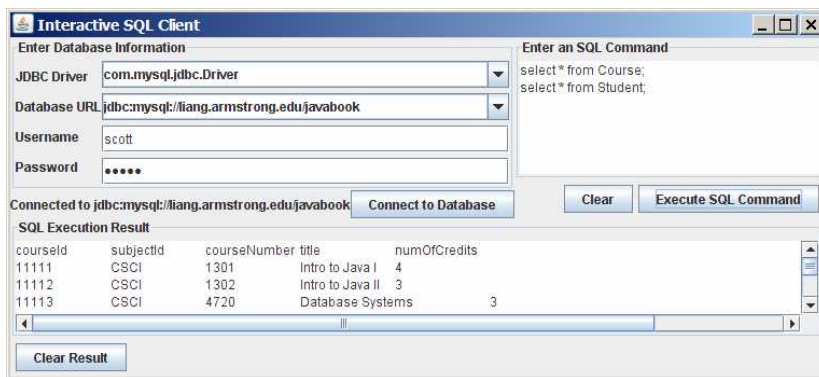


Figure 41.1

You can connect to any JDBC data source and execute SQL commands interactively.

Listing 41.1 SQLClient.java

```
<margin note line 10: connection>
<margin note line 13: statement>
<margin note line 24: URLs>
<margin note line 28: drivers>
<margin note line 47: create UI>
<margin note line 109: execute SQL>
<margin note line 114: connect database>
<margin note line 119: clear command>
<margin note line 124: clear result>
<margin note line 139: load driver>
<margin note line 140: connect to database>
<margin note line 161: process SQL select>
```

<margin note line 164: process non-select>  
<margin note line 222: main method omitted>

```
import java.awt.*;
import java.awt.event.*;
import javax.swing.*;
import javax.swing.border.*;
import java.sql.*;
import java.util.*;

public class SQLClient extends JApplet {
 // Connection to the database
 private Connection connection;

 // Statement to execute SQL commands
 private Statement statement;

 // Text area to enter SQL commands
 private JTextArea jtasqlCommand = new JTextArea();

 // Text area to display results from SQL commands
 private JTextArea jtaSQLResult = new JTextArea();

 // JDBC info for a database connection
 JTextField jtfUsername = new JTextField();
 JPasswordField jpfPassword = new JPasswordField();
 JComboBox jchoURL = new JComboBox(new String[] {
 "jdbc:mysql://localhost/javabook",
 "jdbc:odbc:exampleMDBDataSource",
 "jdbc:oracle:thin:@liang.armstrong.edu:1521:orcl"});
 JComboBox jchoDriver = new JComboBox(new String[] {
 "com.mysql.jdbc.Driver", "sun.jdbc.odbc.JdbcOdbcDriver",
 "oracle.jdbc.driver.OracleDriver"});

 JButton jbtExecuteSQL = new JButton("Execute SQL Command");
 JButton jbtClearSQLCommand = new JButton("Clear");
 JButton jbtConnectDB1 = new JButton("Connect to Database");
 JButton jbtClearSQLResult = new JButton("Clear Result");

 // Create titled borders
 Border titledBorder1 = new TitledBorder("Enter an SQL Command");
 Border titledBorder2 = new TitledBorder("SQL Execution Result");
 Border titledBorder3 = new TitledBorder(
 "Enter Database Information");

 JLabel jlblConnectionStatus = new JLabel("No connection now");

 /** Initialize the applet */
 public void init() {
 JScrollPane jScrollPane1 = new JScrollPane(jtasqlCommand);
 jScrollPane1.setBorder(titledBorder1);
 JScrollPane jScrollPane2 = new JScrollPane(jtaSQLResult);
 jScrollPane2.setBorder(titledBorder2);

 JPanel jPanel1 = new JPanel(new FlowLayout(FlowLayout.RIGHT));
 jPanel1.add(jbtClearSQLCommand);
 jPanel1.add(jbtExecuteSQL);

 JPanel jPanel2 = new JPanel();
```

```

jPanel2.setLayout(new BorderLayout());
jPanel2.add(jScrollPane1, BorderLayout.CENTER);
jPanel2.add(jPanel1, BorderLayout.SOUTH);
jPanel2.setPreferredSize(new Dimension(100, 100));

JPanel jPanel3 = new JPanel();
jPanel3.setLayout(new BorderLayout());
jPanel3.add(jlblConnectionStatus, BorderLayout.CENTER);
jPanel3.add(jbtConnectDB1, BorderLayout.EAST);

JPanel jPanel4 = new JPanel();
jPanel4.setLayout(new GridLayout(4, 1, 10, 5));
jPanel4.add(jcboDriver);
jPanel4.add(jcboURL);
jPanel4.add(jtfUsername);
jPanel4.add(jpfPassword);

JPanel jPanel5 = new JPanel();
jPanel5.setLayout(new GridLayout(4, 1));
jPanel5.add(new JLabel("JDBC Driver"));
jPanel5.add(new JLabel("Database URL"));
jPanel5.add(new JLabel("Username"));
jPanel5.add(new JLabel("Password"));

JPanel jPanel6 = new JPanel();
jPanel6.setLayout(new BorderLayout());
jPanel6.setBorder(titledBorder3);
jPanel6.add(jPanel4, BorderLayout.CENTER);
jPanel6.add(jPanel5, BorderLayout.WEST);

JPanel jPanel7 = new JPanel();
jPanel7.setLayout(new BorderLayout());
jPanel7.add(jPanel3, BorderLayout.SOUTH);
jPanel7.add(jPanel6, BorderLayout.CENTER);

JPanel jPanel8 = new JPanel();
jPanel8.setLayout(new BorderLayout());
jPanel8.add(jPanel2, BorderLayout.CENTER);
jPanel8.add(jPanel7, BorderLayout.WEST);

JPanel jPanel9 = new JPanel(new FlowLayout(FlowLayout.LEFT));
jPanel9.add(jbtClearSQLResult);

jcboURL.setEditable(true);
jcboDriver.setEditable(true);

add(jPanel8, BorderLayout.NORTH);
add(jScrollPane2, BorderLayout.CENTER);
add(jPanel9, BorderLayout.SOUTH);

jbtExecuteSQL.addActionListener(new ActionListener() {
 public void actionPerformed(ActionEvent e) {
 executeSQL();
 }
});
jbtConnectDB1.addActionListener(new ActionListener() {
 public void actionPerformed(ActionEvent e) {
 connectToDB();
 }
});

```



```

 jbtClearSQLCommand.addActionListener(new ActionListener() {
 public void actionPerformed(ActionEvent e) {
 jtasqlCommand.setText(null);
 }
 });
 jbtClearSQLResult.addActionListener(new ActionListener() {
 public void actionPerformed(ActionEvent e) {
 jtaSQLResult.setText(null);
 }
 });
 }

 /** Connect to DB */
 private void connectToDB() {
 // Get database information from the user input
 String driver = (String)jchoDriver.getSelectedItem();
 String url = (String)jchoURL.getSelectedItem();
 String username = jtfUsername.getText().trim();
 String password = new String(jpfPassword.getPassword());

 // Connection to the database
 try {
 connection = DriverManager.getConnection(
 url, username, password);
 lblConnectionStatus.setText("Connected to " + url);
 }
 catch (java.lang.Exception ex) {
 ex.printStackTrace();
 }
 }

 /** Execute SQL commands */
 private void executeSQL() {
 if (connection == null) {
 jtaSQLResult.setText("Please connect to a database first");
 return;
 }
 else {
 String sqlCommands = jtasqlCommand.getText().trim();
 String[] commands = sqlCommands.replace('\n', ' ').split(";");

 for (String aCommand: commands) {
 if (aCommand.trim().toUpperCase().startsWith("SELECT")) {
 processSQLSelect(aCommand);
 }
 else {
 processSQLNonSelect(aCommand);
 }
 }
 }
 }

 /** Execute SQL SELECT commands */
 private void processSQLSelect(String sqlCommand) {
 try {
 // Get a new statement for the current connection
 statement = connection.createStatement();

 // Execute a SELECT SQL command
 ResultSet resultSet = statement.executeQuery(sqlCommand);
 }
 }

```

```

// Find the number of columns in the result set
int columnCount = resultSet.getMetaData().getColumnCount();
String row = "";

// Display column names
for (int i = 1; i <= columnCount; i++) {
 row += resultSet.getMetaData().getColumnName(i) + "\t";
}

jtaSQLResult.append(row + '\n');

while (resultSet.next()) {
 // Reset row to empty
 row = "";

 for (int i = 1; i <= columnCount; i++) {
 // A non-String column is converted to a string
 row += resultSet.getString(i) + "\t";
 }

 jtaSQLResult.append(row + '\n');
}
}
catch (SQLException ex) {
 jtaSQLResult.setText(ex.toString());
}
}

/** Execute SQL DDL, and modification commands */
private void processSQLNonSelect(String sqlCommand) {
 try {
 // Get a new statement for the current connection
 statement = connection.createStatement();

 // Execute a non-SELECT SQL command
 statement.executeUpdate(sqlCommand);

 jtaSQLResult.setText("SQL command executed");
 }
 catch (SQLException ex) {
 jtaSQLResult.setText(ex.toString());
 }
}
}
}

```

The user selects or enters the JDBC driver, database URL, username, and password, and clicks the *Connect to Database* button to connect to the specified database using the `connectToDB()` method (lines 130-147).

When the user clicks the *Execute SQL Command* button, the `executeSQL()` method is invoked (lines 150-168) to get the SQL commands from the text area (`jtaSQLCommand`) and extract each command separated by a semicolon (;). It then determines whether the command is a SELECT query or a DDL or data modification statement (lines 160-165). If the command is a SELECT query, the `processSQLSelect` method is invoked (lines 171-205). This method uses the `executeQuery` method (line 177) to obtain the query result. The result is displayed in the text area `jtaSQLResult` (line 188). If the command is a non-SELECT query, the `processSQLNonSelect()`

method is invoked (lines 208-221). This method uses the `executeUpdate` method (line 214) to execute the SQL command.

The `getMetaData` method (lines 180, 185) in the `ResultSet` interface is used to obtain an instance of `ResultSetMetaData`. The `getColumnCount` method (line 180) returns the number of columns in the result set, and the `getColumnName(i)` method (line 185) returns the column name for the *i*th column.

### 41.3 Batch Processing

In all the preceding examples, SQL commands are submitted to the database for execution one at a time. This is inefficient for processing a large number of updates. For example, suppose you wanted to insert a thousand rows into a table. Submitting one INSERT command at a time would take nearly a thousand times longer than submitting all the INSERT commands in a batch at once. To improve performance, JDBC introduced the batch update for processing nonselect SQL commands. A batch update consists of a sequence of nonselect SQL commands. These commands are collected in a batch and submitted to the database all together. To use the batch update, you add nonselect commands to a batch using the `addBatch` method in the `Statement` interface. After all the SQL commands are added to the batch, use the `executeBatch` method to submit the batch to the database for execution.

For example, the following code adds a create table command, adds two insert statements in a batch, and executes the batch.

```
Statement statement = connection.createStatement();

// Add SQL commands to the batch
statement.addBatch("create table T (C1 integer, C2 varchar(15))");
statement.addBatch("insert into T values (100, 'Smith')");
statement.addBatch("insert into T values (200, 'Jones')");

// Execute the batch
int count[] = statement.executeBatch();
```

The `executeBatch()` method returns an array of counts, each of which counts the number of rows affected by the SQL command. The first count returns `0` because it is a DDL command. The other counts return `1` because only one row is affected.

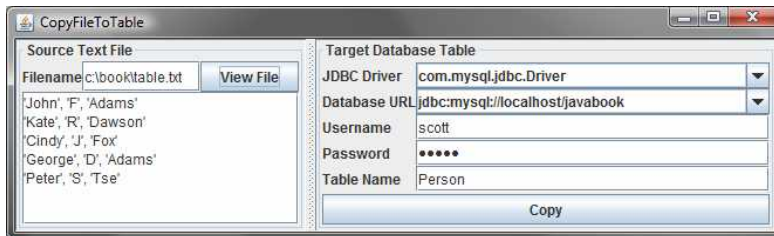
NOTE: To find out whether a driver supports batch updates, invoke `supportsBatchUpdates()` on a `DatabaseMetaData` instance. If the driver supports batch updates, it will return `true`. The JDBC drivers for MySQL, Access, and Oracle all support batch updates.

To demonstrate batch processing, consider writing a program that gets data from a text file and copies the data from the text file to a table, as shown in Figure 41.2. The text file consists of lines that each corresponds to a row in the table. The fields in a row are separated by commas. The string values in a row are enclosed in single quotes. You can view the text file by clicking the *View File* button and copy the text to the table by clicking the *Copy* button. The table must already be defined in the database. Figure 41.2 shows the text file `table.txt` copied to table `Person`. `Person` is created using the following statement:

```

create table Person (
 firstName varchar(20),
 mi char(1),
 lastName varchar(20)
)

```



**Figure 41.2**

The CopyFileToTable utility copies text files to database tables.

Listing 41.2 gives the solution to the problem.

**Listing 41.2 CopyFileToTable.java**

```

<margin note line 15: drivers>
<margin note line 18: URLs>
<margin note line 31: create UI>
<margin note line 74: view file>
<margin note line 81: to table>
<margin note line 114: load driver>
<margin note line 118: connect database>
<margin note line 125: insert row>
<margin note line 144: statement>
<margin note line 154: batch>
<margin note line 180: execute batch>
<margin note line 199: main method omitted>

import javax.swing.*;
import javax.swing.border.*;
import java.awt.*;
import java.awt.event.*;
import java.io.*;
import java.sql.*;
import java.util.*;

public class CopyFileToTable extends JFrame {
 // Text file info
 private JTextField jtffilename = new JTextField();
 private JTextArea jtaFile = new JTextArea();

 // JDBC and table info
 private JComboBox jcboDriver = new JComboBox(new String[] {
 "com.mysql.jdbc.Driver", "sun.jdbc.odbc.JdbcOdbcDriver",
 "oracle.jdbc.driver.OracleDriver"});
 private JComboBox jcboURL = new JComboBox(new String[] {
 "jdbc:mysql://localhost/javabook",
 "jdbc:odbc:exampleMDBDataSource",

```

```

"jdbc:oracle:thin:@liang.armstrong.edu:1521:orcl"));
private JTextField jtfUsername = new JTextField();
private JPasswordField jtfPassword = new JPasswordField();
private JTextField jtfTableName = new JTextField();

private JButton jbtViewFile = new JButton("View File");
private JButton jbtCopy = new JButton("Copy");
private JLabel jlblStatus = new JLabel();

public CopyFileToTable() {
 JPanel jPanel1 = new JPanel();
 jPanel1.setLayout(new BorderLayout());
 jPanel1.add(new JLabel("Filename"), BorderLayout.WEST);
 jPanel1.add(jbtViewFile, BorderLayout.EAST);
 jPanel1.add(jtfFilename, BorderLayout.CENTER);

 JPanel jPanel2 = new JPanel();
 jPanel2.setLayout(new BorderLayout());
 jPanel2.setBorder(new TitledBorder("Source Text File"));
 jPanel2.add(jPanel1, BorderLayout.NORTH);
 jPanel2.add(new JScrollPane(jtaFile), BorderLayout.CENTER);

 JPanel jPanel3 = new JPanel();
 jPanel3.setLayout(new GridLayout(5, 0));
 jPanel3.add(new JLabel("JDBC Driver"));
 jPanel3.add(new JLabel("Database URL"));
 jPanel3.add(new JLabel("Username"));
 jPanel3.add(new JLabel("Password"));
 jPanel3.add(new JLabel("Table Name"));

 JPanel jPanel4 = new JPanel();
 jPanel4.setLayout(new GridLayout(5, 0));
 jcboDriver.setEditable(true);
 jPanel4.add(jcboDriver);
 jcboURL.setEditable(true);
 jPanel4.add(jcboURL);
 jPanel4.add(jtfUsername);
 jPanel4.add(jtfPassword);
 jPanel4.add(jtfTableName);

 JPanel jPanel5 = new JPanel();
 jPanel5.setLayout(new BorderLayout());
 jPanel5.setBorder(new TitledBorder("Target Database Table"));
 jPanel5.add(jbtCopy, BorderLayout.SOUTH);
 jPanel5.add(jPanel3, BorderLayout.WEST);
 jPanel5.add(jPanel4, BorderLayout.CENTER);

 add(jlblStatus, BorderLayout.SOUTH);
 add(new JSplitPane(JSplitPane.HORIZONTAL_SPLIT,
 jPanel2, jPanel5), BorderLayout.CENTER);

 jbtViewFile.addActionListener(new ActionListener() {
 public void actionPerformed(ActionEvent evt) {
 showFile();
 }
 });

 jbtCopy.addActionListener(new ActionListener() {
 public void actionPerformed(ActionEvent evt) {
 try {

```

```

 copyFile();
 }
 catch (Exception ex) {
 lblStatus.setText(ex.toString());
 }
}
});
}

/** Display the file in the text area */
private void showFile() {
 Scanner input = null;
 try {
 // Use a Scanner to read text from the file
 input = new Scanner(new File(jtfFilename.getText().trim()));

 // Read a line and append the line to the text area
 while (input.hasNext())
 jtaFile.append(input.nextLine() + '\n');
 }
 catch (FileNotFoundException ex) {
 System.out.println("File not found: " + jtfFilename.getText());
 }
 catch (IOException ex) {
 ex.printStackTrace();
 }
 finally {
 if (input != null) input.close();
 }
}

private void copyFile() throws Exception {
 // Load the JDBC driver
 Class.forName(((String)jcboDriver.getSelectedItem()).trim());
 System.out.println("Driver loaded");

 // Establish a connection
 Connection conn = DriverManager.getConnection(
 (((String)jcboURL.getSelectedItem()).trim()),
 jtfUsername.getText().trim(),
 String.valueOf(jtfPassword.getPassword()).trim());
 System.out.println("Database connected");

 // Read each line from the text file and insert it to the table
 insertRows(conn);
}

private void insertRows(Connection connection) {
 // Build the SQL INSERT statement
 String sqlInsert = "insert into " + jtfTableName.getText()
 + " values (";

 // Use a Scanner to read text from the file
 Scanner input = null;

 // Get file name from the text field
 String filename = jtfFilename.getText().trim();

 try {
 // Create a scanner

```

```

input = new Scanner(new File(filename));

// Create a statement
Statement statement = connection.createStatement();

System.out.println("Driver major version? " +
 connection.getMetaData().getDriverMajorVersion());

// Determine if batchUpdatesSupported is supported
boolean batchUpdatesSupported = false;

try {
 if (connection.getMetaData().supportsBatchUpdates()) {
 batchUpdatesSupported = true;
 System.out.println("batch updates supported");
 }
 else {
 System.out.println("The driver " +
 "does not support batch updates");
 }
}
catch (UnsupportedOperationException ex) {
 System.out.println("The operation is not supported");
}

// Determine if the driver is capable of batch updates
if (batchUpdatesSupported) {
 // Read a line and add the insert table command to the batch
 while (input.hasNext()) {
 statement.addBatch(sqlInsert + input.nextLine() + " ");
 }

 statement.executeBatch();

 jlblStatus.setText("Batch updates completed");
}
else {
 // Read a line and execute insert table command
 while (input.hasNext()) {
 statement.executeUpdate(sqlInsert + input.nextLine() + " ");
 }

 jlblStatus.setText("Single row update completed");
}
}
catch (SQLException ex) {
 System.out.println(ex);
}
catch (FileNotFoundException ex) {
 System.out.println("File not found: " + filename);
}
finally {
 if (input != null) input.close();
}
}
}

```

The `insertRows` method (lines 128-195) uses the batch updates to submit SQL INSERT commands to the database for execution, if the driver supports batch updates. Lines 152-164 check whether the driver supports

batch updates. If the driver does not support the operation, an `UnsupportedOperationException` exception will be thrown (line 162) when the `supportsBatchUpdates()` method is invoked.

The tables must already be created in the database. The file format and contents must match the database table specification. Otherwise, the SQL `INSERT` command will fail.

In Exercise 41.1, you will write a program to insert a thousand records to a database and compare the performance with and without batch updates.

#### 41.4 Scrollable and Updatable Result Set

##### <margin note: sequential forward reading>

The result sets used in the preceding examples are read sequentially. A result set maintains a cursor pointing to its current row of data. Initially the cursor is positioned before the first row. The `next()` method moves the cursor forward to the next row. This is known as *sequential forward reading*. It is the only way of processing the rows in a result set that is supported by JDBC 1.

With the new versions of JDBC, you can scroll the rows both forward and backward and move the cursor to a desired location using the `first`, `last`, `next`, `previous`, `absolute`, or `relative` method. Additionally, you can insert, delete, or update a row in the result set and have the changes automatically reflected in the database.

To obtain a scrollable or updatable result set, you must first create a statement with an appropriate type and concurrency mode. For a static statement, use

```
Statement statement = connection.createStatement
 (int resultSetType, int resultSetConcurrency);
```

For a prepared statement, use

```
PreparedStatement statement = connection.prepareStatement
 (String sql, int resultSetType, int resultSetConcurrency);
```

##### <margin note: scrollable?>

The possible values of `resultSetType` are the constants defined in the `ResultSet`:

- `TYPE_FORWARD_ONLY`: The result set is accessed forward sequentially.
- `TYPE_SCROLL_INSENSITIVE`: The result set is scrollable, but not sensitive to changes in the database.
- `TYPE_SCROLL_SENSITIVE`: The result set is scrollable and sensitive to changes made by others. Use this type if you want the result set to be scrollable and updatable.

##### <margin note: updatable?>

The possible values of `resultSetConcurrency` are the constants defined in the `ResultSet`:

- `CONCUR_READ_ONLY`: The result set cannot be used to update the database.



- CONCUR UPDATABLE: The result set can be used to update the database.

For example, if you want the result set to be scrollable and updatable, you can create a statement, as follows:

```
Statement statement = connection.createStatement
(ResultSet.TYPE_SCROLL_SENSITIVE, ResultSet.CONCUR_UPDATABLE)
```

You use the executeQuery method in a Statement object to execute an SQL query that returns a result set as follows:

```
ResultSet resultSet = statement.executeQuery(query);
```

**<margin note: ResultSet methods>**

You can now use the methods first(), next(), previous(), and last() to move the cursor to the first row, next row, previous row, and last row. The absolute(int row) method moves the cursor to the specified row; and the getXxx(int columnIndex) or getXxx(String columnName) method is used to retrieve the value of a specified field at the current row. The methods insertRow(), deleteRow(), and updateRow() can also be used to insert, delete, and update the current row. Before applying insertRow or updateRow, you need to use the method updateXxx(int columnIndex, Xxx value) or update(String columnName, Xxx value) to write a new value to the field at the current row. The cancelRowUpdates() method cancels the updates made to a row. The close() method closes the result set and releases its resource. The wasNull() method returns true if the last column read had a value of SQL NULL.

Listing 41.3 gives an example that demonstrates how to create a scrollable and updatable result set. The program creates a result set for the StateCapital table. The StateCapital table is defined as follows:

```
create table StateCapital (
 state varchar(40),
 capital varchar(40)
);
```

**Listing 41.3 ScrollUpdateResultSet.java**

```
<margin note line 7: load driver>
<margin note line 11: connect to DB>
<margin note line 14: set auto commit>
<margin note line 18: scrollable updatable>
<margin note line 22: get result set>
<margin note line 29: move cursor>
<margin note line 32: update row>
<margin note line 35: move cursor>
<margin note line 39: insert row>
<margin note line 43: move cursor>
<margin note line 44: delete row>
<margin note line 52: close result set>
<margin note line 55: display result set>
```

```
import java.sql.*;
```

```

public class ScrollUpdateResultSet {
 public static void main(String[] args)
 throws SQLException, ClassNotFoundException {
 // Load the JDBC driver
 Class.forName("oracle.jdbc.driver.OracleDriver");
 System.out.println("Driver loaded");

 // Connect to a database
 Connection connection = DriverManager.getConnection
 ("jdbc:oracle:thin:@liang.armstrong.edu:1521:orcl",
 "scott", "tiger");
 connection.setAutoCommit(true);
 System.out.println("Database connected");

 // Get a new statement for the current connection
 Statement statement = connection.createStatement(
 ResultSet.TYPE_SCROLL_SENSITIVE, ResultSet.CONCUR_UPDATABLE);

 // Get ResultSet
 ResultSet resultSet = statement.executeQuery
 ("select state, capital from StateCapital");

 System.out.println("Before update ");
 displayResultSet(resultSet);

 // Update the second row
 resultSet.absolute(2); // Move cursor to the second row
 resultSet.updateString("state", "New S"); // Update the column
 resultSet.updateString("capital", "New C"); // Update the column
 resultSet.updateRow(); // Update the row in the data source

 // Insert after the last row
 resultSet.last();
 resultSet.moveToInsertRow(); // Move cursor to the insert row
 resultSet.updateString("state", "Florida");
 resultSet.updateString("capital", "Tallahassee");
 resultSet.insertRow(); // Insert the row
 resultSet.moveToCurrentRow(); // Move the cursor to the current row

 // Delete fourth row
 resultSet.absolute(4); // Move cursor to the 5th row
 resultSet.deleteRow(); // Delete the second row

 System.out.println("After update ");
 resultSet = statement.executeQuery
 ("select state, capital from StateCapital");
 displayResultSet(resultSet);

 // Close the connection
 resultSet.close();
 }

 private static void displayResultSet(ResultSet resultSet)
 throws SQLException {
 ResultSetMetaData rsMetaData = resultSet.getMetaData();
 resultSet.beforeFirst();
 while (resultSet.next()) {
 for (int i = 1; i <= rsMetaData.getColumnCount(); i++)
 System.out.printf("%-12s\t", resultSet.getObject(i));
 System.out.println();
 }
 }
}

```

```
 }
 }
}
```

### <Output>

```
Driver loaded
Database connected
```

```
Before update
Indiana Indianapolis
Illinois Springfield
California Sacramento
Georgia Atlanta
Texas Austin
```

```
After update
Indiana Indianapolis
New S New C
California Sacramento
Texas Austin
Florida Tallahassee
```

### <End Output>

#### <margin note: scrollable and updatable>

The code in lines 18-19 creates a Statement for producing scrollable and updatable result sets.

#### <margin note: update row>

The program moves the cursor to the second row in the result set (line 29), updates two columns in this row (lines 30-31), and invokes the updateRow() method to update the row in the underlying database (line 32).

#### <margin note: insert row>

An updatable ResultSet object has a special row associated with it that serves as a staging area for building a row to be inserted. This special row is called the *insert row*. To insert a row, first invoke the moveToInsertRow() method to move the cursor to the insert row (line 36), then update the columns using the updateXxx method (lines 37-38), and finally insert the row using the insertRow() method (line 39). Invoking moveToCurrentRow() moves the cursor to the current inserted row (lines 40).

#### <margin note: insert row>

The program moves to the fourth row and invokes the deleteRow() method to delete the row from the database (lines 43-44).

#### <margin note: driver support>

NOTE: Not all current drivers support scrollable and updatable result sets. The example is tested using Oracle ojdbc6 driver. You can use supportsResultSetType(int type) and supportsResultSetConcurrency(int type, int concurrency) in the DatabaseMetaData interface to find out which result type and currency modes are supported by the JDBC driver. But even if a driver supports the scrollable and updatable result set, a result set for a

complex query might not be able to perform an update. For example, the result set for a query that involves several tables is likely not to support update operations.

NOTE: The program may not work, if lines 22-23 are replaced by

```
ResultSet resultSet = statement.executeQuery
 ("select * from StateCapital");
```

#### 41.5 RowSet, JdbcRowSet, and CachedRowSet

##### <margin note: extends ResultSet>

JDBC introduced a new RowSet interface that can be used to simplify database programming. The RowSet interface extends java.sql.ResultSet with additional capabilities that allow a RowSet instance to be configured to connect to a JDBC url, username, and password, set an SQL command, execute the command, and retrieve the execution result. In essence, it combines Connection, Statement, and ResultSet into one interface.

NOTE:

##### <margin note: supported?>

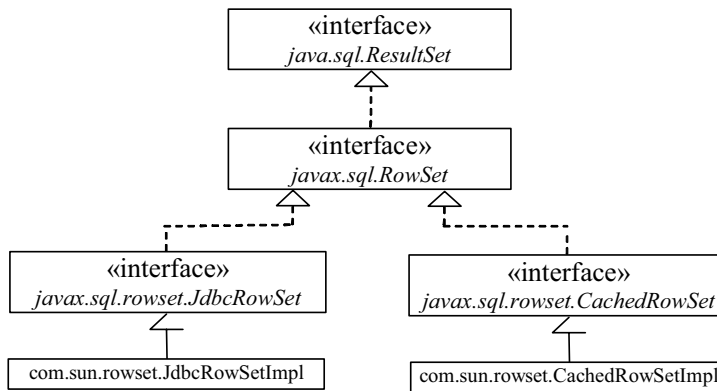
Not all JDBC drivers support RowSet. Currently, the JDBC-ODBC driver does not support all features of RowSet.

##### 41.5.1 RowSet Basics

##### <margin note: connected vs. disconnected>

There are two types of RowSet objects: connected and disconnected. A *connected* RowSet object makes a connection with a data source and maintains that connection throughout its life cycle. A *disconnected* RowSet object makes a connection with a data source, executes a query to get data from the data source, and then closes the connection. A *disconnected* rowset may make changes to its data while it is disconnected and then send the changes back to the original source of the data, but it must reestablish a connection to do so.

There are several versions of RowSet. Two frequently used are JdbcRowSet and CachedRowSet. Both are subinterfaces of RowSet. JdbcRowSet is *connected*, while CachedRowSet is *disconnected*. Also, JdbcRowSet is neither serializable nor cloneable, while CachedRowSet is both. The database vendors are free to provide concrete implementations for these interfaces. Sun has provided the reference implementation JdbcRowSetImpl for JdbcRowSet and CachedRowSetImpl for CachedRowSet. Figure 41.3 shows the relationship of these components.



**Figure 41.3**

The `JdbcRowSetImpl` and `CachedRowSetImpl` are concrete implementations of `RowSet`.

The `RowSet` interface contains the JavaBeans properties with `get` and `set` methods. You can use the `set` methods to set a new `url`, `username`, `password`, and `command` for an SQL statement. Using a `RowSet`, Listing 37.1 can be simplified, as shown in Listing 41.4.

**Listing 41.4 SimpleRowSet.java**

```

<margin note line 9: load driver>
<margin note line 13: create RowSet>
<margin note line 16: set url>
<margin note line 17: set username>
<margin note line 18: set password>
<margin note line 19: set command>
<margin note line 21: execute command>
<margin note line 25: get result>
<margin note line 29: close connection>
import java.sql.SQLException;
import javax.sql.RowSet;
import com.sun.rowset.*;

public class SimpleRowSet {
 public static void main(String[] args)
 throws SQLException, ClassNotFoundException {
 // Load the JDBC driver
 Class.forName("com.mysql.jdbc.Driver");
 System.out.println("Driver loaded");

 // Create a row set
 RowSet rowSet = new JdbcRowSetImpl();

 // Set RowSet properties
 rowSet.setUrl("jdbc:mysql://localhost/javabook");
 rowSet.setUsername("scott");
 rowSet.setPassword("tiger");
 }
}

```

```

rowSet.setCommand("select firstName, mi, lastName " +
"from Student where lastName = 'Smith'");
rowSet.execute();

// Iterate through the result and print the student names
while (rowSet.next())
 System.out.println(rowSet.getString(1) + "\t" +
 rowSet.getString(2) + "\t" + rowSet.getString(3));

// Close the connection
rowSet.close();
}
}

```

Line 13 creates a `RowSet` object using `JdbcRowSetImpl`. The program uses the `RowSet`'s `set` method to set a URL, username, and password (lines 16-18) and a command for a query statement (line 19). Line 24 executes the command in the `RowSet`. The methods `next()` and `getString(int)` for processing the query result (lines 25-26) are inherited from `ResultSet`.

**<margin note: using `CachedRowSet`>**

If you replace `JdbcRowSet` with `CachedRowSet` in line 13, the program will work just fine. Note that the JDBC-ODBC driver supports `JdbcRowSetImpl`, but not `CachedRowSetImpl`.

TIP

**<margin note: obtain metadata>**

Since `RowSet` is a subinterface of `ResultSet`, all the methods in `ResultSet` can be used in `RowSet`. For example, you can obtain `ResultSetMetaData` from a `RowSet` using the `getMetaData()` method.

#### 41.5.2 `RowSet` for `PreparedStatement`

The discussion in §37.5, "PreparedStatement," introduced processing parameterized SQL statements using the `PreparedStatement` interface. `RowSet` has the capability to support parameterized SQL statements. The set methods for setting parameter values in `PreparedStatement` are implemented in `RowSet`. You can use these methods to set parameter values for a parameterized SQL command. Listing 41.5 demonstrates how to use a parameterized statement in `RowSet`. Line 19 sets an SQL query statement with two parameters for `lastName` and `mi` in a `RowSet`. Since these two parameters are strings, the `setString` method is used to set actual values in lines 21-22.

**Listing 41.5 `RowSetPreparedStatement.java`**

```

<margin note line 9: load driver>
<margin note line 13: create RowSet>
<margin note line 16: set url>
<margin note line 19: SQL with parameters>
<margin note line 21: set parameter>
<margin note line 22: set parameter>
<margin note line 23: execute>
<margin note line 25: metadata>
<margin note line 38: close connection>

```

```

import java.sql.*;
import javax.sql.RowSet;
import com.sun.rowset.*;

public class RowSetPreparedStatement {
 public static void main(String[] args)
 throws SQLException, ClassNotFoundException {
 // Load the JDBC driver
 Class.forName("com.mysql.jdbc.Driver");
 System.out.println("Driver loaded");

 // Create a row set
 RowSet rowSet = new JdbcRowSetImpl();

 // Set RowSet properties
 rowSet.setUrl("jdbc:mysql://localhost/javabook");
 rowSet.setUsername("scott");
 rowSet.setPassword("tiger");
 rowSet.setCommand("select * from Student where lastName = ? " +
 "and mi = ?");
 rowSet.setString(1, "Smith");
 rowSet.setString(2, "R");
 rowSet.execute();

 ResultSetMetaData rsMetaData = rowSet.getMetaData();
 for (int i = 1; i <= rsMetaData.getColumnCount(); i++)
 System.out.printf("%-12s\t", rsMetaData.getColumnName(i));
 System.out.println();

 // Iterate through the result and print the student names
 while (rowSet.next()) {
 for (int i = 1; i <= rsMetaData.getColumnCount(); i++)
 System.out.printf("%-12s\t", rowSet.getObject(i));
 System.out.println();
 }

 // Close the connection
 rowSet.close();
 }
}

```

#### 41.5.3 Scrolling and Updating RowSet

By default, a `ResultSet` object is neither scrollable nor updatable. However, a `RowSet` object is both. It is easier to scroll and update a database through a `RowSet` than through a `ResultSet`. Listing 41.6 rewrites Listing 41.3 using a `RowSet`. You can use methods such as `absolute(int)` to move the cursor and methods such as `delete()`, `updateRow()`, and `insertRow()` to update the database.

#### Listing 41.6 ScrollUpdateRowSet.java

<margin note line 9: load driver>  
 <margin note line 13: create a RowSet>

<margin note line 16: set url>  
 <margin note line 17: set username>  
 <margin note line 18: set password>  
 <margin note line 19: set SQL command>  
 <margin note line 20: execute>  
 <margin note line 23: display rowSet>  
 <margin note line 26: move cursor>  
 <margin note line 29: update row>  
 <margin note line 34: prepare insert>  
 <margin note line 36: insert row>  
 <margin note line 41: delete row>  
 <margin note line 47: close rowSet>

```

import java.sql.*;
import javax.sql.RowSet;
import com.sun.rowset.JdbcRowSetImpl;

public class ScrollUpdateRowSet {
 public static void main(String[] args)
 throws SQLException, ClassNotFoundException {
 // Load the JDBC driver
 Class.forName("oracle.jdbc.driver.OracleDriver");
 System.out.println("Driver loaded");

 // Create a row set
 RowSet rowSet = new JdbcRowSetImpl();

 // Set RowSet properties
 rowSet.setUrl("jdbc:oracle:thin:@liang.armstrong.edu:1521:orcl");
 rowSet.setUsername("scott");
 rowSet.setPassword("tiger");
 rowSet.setCommand("select state, capital from StateCapital");
 rowSet.execute();

 System.out.println("Before update ");
 displayRowSet(rowSet);

 // Update the second row
 rowSet.absolute(2); // Move cursor to the 2nd row
 rowSet.updateString("state", "New S"); // Update the column
 rowSet.updateString("capital", "New C"); // Update the column
 rowSet.updateRow(); // Update the row in the data source

 // Insert after the second row
 rowSet.last();
 rowSet.moveToInsertRow(); // Move cursor to the insert row
 rowSet.updateString("state", "Florida");
 rowSet.updateString("capital", "Tallahassee");
 rowSet.insertRow(); // Insert the row
 rowSet.moveToCurrentRow(); // Move the cursor to the current row

 // Delete fourth row
 rowSet.absolute(4); // Move cursor to the fifth row
 rowSet.deleteRow(); // Delete the second row

```



```

 System.out.println("After update ");
 displayRowSet(rowSet);

 // Close the connection
 rowSet.close();
 }

 private static void displayRowSet(RowSet rowSet)
 throws SQLException {
 ResultSetMetaData rsMetaData = rowSet.getMetaData();
 rowSet.beforeFirst();
 while (rowSet.next()) {
 for (int i = 1; i <= rsMetaData.getColumnCount(); i++)
 System.out.printf("%-12s\t", rowSet.getObject(i));
 System.out.println();
 }
 }
}

```

**<margin note: updating CachedRowSet>**

If you replace `JdbcRowSet` with `CachedRowSet` in line 13, the database is not changed. To make the changes on the `CachedRowSet` effective in the database, you must invoke the `acceptChanges()` method after you make all the changes, as follows:

```

// Write changes back to the database
((com.sun.rowset.CachedRowSetImpl)rowSet).acceptChanges();

```

This method automatically reconnects to the database and writes all the changes back to the database.

#### 41.5.4 RowSetEvent

A `RowSet` object fires a `RowSetEvent` whenever the object's cursor has moved, a row has changed, or the entire row set has changed. This event can be used to synchronize a `RowSet` with the components that rely on the `RowSet`. For example, a visual component that displays the contents of a `RowSet` should be synchronized with the `RowSet`. The `RowSetEvent` can be used to achieve synchronization. The handlers in `RowSetListener` are `cursorMoved(RowSetEvent)`, `rowChanged(RowSetEvent)`, and `cursorSetChanged(RowSetEvent)`.

Listing 41.7 gives an example that demonstrates `RowSetEvent`. A listener for `RowSetEvent` is registered in lines 14-26. When `rowSet.execute()` (line 33) is executed, the entire row set is changed, so the listener's `rowSetChanged` handler is invoked. When `rowSet.last()` (line 35) is executed, the cursor is moved, so the listener's `cursorMoved` handler is invoked. When `rowSet.updateRow()` (line 37) is executed, the row is updated, so the listener's `rowChanged` handler is invoked.

#### Listing 41.7 TestRowSetEvent.java

**<margin note line 9: load driver>**  
**<margin note line 13: create RowSet>**  
**<margin note line 14: register listener>**

<margin note line 33: row set changed>

<margin note line 35: cursor moved>

<margin note line 37: row updated>

```
import java.sql.*;
import javax.sql.*;
import com.sun.rowset.*;

public class TestRowSetEvent {
 public static void main(String[] args)
 throws SQLException, ClassNotFoundException {
 // Load the JDBC driver
 Class.forName("com.mysql.jdbc.Driver");
 System.out.println("Driver loaded");

 // Create a row set
 RowSet rowSet = new JdbcRowSetImpl();
 rowSet.addRowSetListener(new RowSetListener() {
 public void cursorMoved(RowSetEvent e) {
 System.out.println("Cursor moved");
 }

 public void rowChanged(RowSetEvent e) {
 System.out.println("Row changed");
 }

 public void rowSetChanged(RowSetEvent e) {
 System.out.println("row set changed");
 }
 });

 // Set RowSet properties
 rowSet.setUrl("jdbc:mysql://localhost/javabook");
 rowSet.setUsername("scott");
 rowSet.setPassword("tiger");
 rowSet.setCommand("select * from Student");
 rowSet.execute();

 rowSet.last(); // Cursor moved
 rowSet.updateString("lastName", "Yao"); // Update column
 rowSet.updateRow(); // Row updated

 // Close the connection
 rowSet.close();
 }
}
```

#### 41.6 Custom RowSetTableModel

Often you need to display a query result set in a JTable. You may define a table model for a row set and plug this model to a JTable. To define a table model, extend the AbstractTableModel class and implement at least three methods: getRowCount(), getColumnCount(), and getValueAt(int row,

int column). The `AbstractTableModel` class was introduced in §40.3, “Table Models and Table Column Models.”

Listing 41.8 shows the `RowSetTableModel` class.

#### Listing 41.8 `RowSetTableModel.java`

```
<margin note line 8: rowSet>
<margin note line 11: getRowSet>
<margin note line 16: setRowSet>
<margin note line 19: add listener>
<margin note line 25: getRowCount()>
<margin note line 38: getColumnCount()>
<margin note line 52: getValueAt>
<margin note line 65: getColumnName()>
<margin note line 77: rowSetChanged>
<margin note line 83: rowChanged>
<margin note line 89: cursorMoved>

import java.sql.*;
import javax.sql.*;
import javax.swing.table.AbstractTableModel;

public class RowSetTableModel extends AbstractTableModel
 implements RowSetListener {
 // RowSet for the result set
 private RowSet rowSet;

 /** Return the rowset */
 public RowSet getRowSet() {
 return rowSet;
 }

 /** Set a new rowset */
 public void setRowSet(RowSet rowSet) {
 if (rowSet != null) {
 this.rowSet = rowSet;
 rowSet.addRowSetListener(this);
 fireTableStructureChanged();
 }
 }

 /** Return the number of rows in the row set */
 public int getRowCount() {
 try {
 rowSet.last();
 return rowSet.getRow(); // Get the current row number
 }
 catch (Exception ex) {
 ex.printStackTrace();
 }
 }

 return 0;
}
```

```

 /** Return the number of columns in the row set */
 public int getColumnCount() {
 try {
 if (rowSet != null) {
 return rowSet.getMetaData().getColumnCount();
 }
 }
 catch (SQLException ex) {
 ex.printStackTrace();
 }

 return 0;
 }

 /** Return value at the specified row and column */
 public Object getValueAt(int row, int column) {
 try {
 rowSet.absolute(row + 1);
 return rowSet.getObject(column + 1);
 }
 catch (SQLException sqlEx) {
 sqlEx.printStackTrace();
 }

 return null;
 }

 /** Return the column name at a specified column */
 public String getColumnName(int column) {
 try {
 return rowSet.getMetaData().getColumnLabel(column + 1);
 }
 catch (SQLException ex) {
 ex.printStackTrace();
 }

 return "";
 }

 /** Implement rowSetChanged */
 public void rowSetChanged(RowSetEvent e) {
 System.out.println("RowSet changed");
 fireTableStructureChanged();
 }

 /** Implement rowChanged */
 public void rowChanged(RowSetEvent e) {
 System.out.println("Row changed");
 fireTableDataChanged();
 }

 /** Implement cursorMoved */
 public void cursorMoved(RowSetEvent e) {

```

```

 System.out.println("Cursor moved");
 }
}

```

The `RowSetTableModel` class defines the `rowSet` property with `get` and `set` methods (lines 11-22). The `setRowSet` method sets a new `rowSet` in the model. The model becomes a listener for the `rowSet` (line 19) in response to the changes in the `rowSet`. The `fireTableStructureChanged()` method defined in `AbstractTableModel` is invoked to refill the model with the data in `rowSet` (line 20).

The `getRowCount()` method returns the number of rows in the `rowSet`. Invoking `rowSet.last()` moves the cursor to the last row (line 27), and `rowSet.getRow()` returns the row number (line 28).

The `getColumnCount()` method returns the number of columns in the `rowSet`. The number of the columns in the `rowSet` can be obtained from the meta data (line 41).

The `getValueAt(row, column)` method returns the cell value at the specified `row` and `column` (lines 52-62). The `getColumnName(column)` method returns the column name for the specified column (lines 65-74).

NOTE

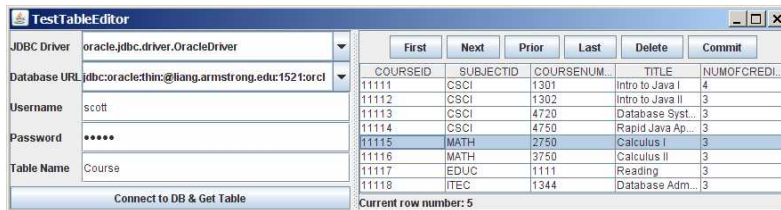
**<margin note: index inconsistency>**

The index of row and column in `JTable` is 0-based.

However, the index of row and column in `RowSet` is 1-based.

The `RowSetTableModel` implements the `RowSetListener` (lines 77-91). So, a `RowSetTableModel` can be a listener for `RowSet` events.

Now let us turn our attention to developing a useful utility that displays a row set in a `JTable`. As shown in Figure 41.4, you enter or select a JDBC driver and database, enter a username and a password, and specify a table name to connect the database and display the table contents in the `JTable`. You can then use the buttons *First*, *Next*, *Prior*, *Last*, *Delete*, and *Commit* to move the cursor to the first row, next row, previous row, and last row in the table, use the *Delete* button to delete a selected row, and use the *Commit* button to save the change in the database.



**Figure 41.4**

*The program enables you to navigate the table and delete rows.*

The status bar at the bottom of the window shows the current row in the row set. The cursor in the row set and the row in the `JTable` are synchronized. You can move the cursor by using the navigation buttons or by selecting a row in the `JTable`.

Define two classes: `TestTableEditor` (Listing 41.9) and `TableEditor` (Listing 41.10). `TestTableEditor` is the main class that enables the user to enter the database connection information and a table name. Once the database is connected, the table contents are displayed in an instance of `TableEditor`. The `TableEditor` class can be used to browse a table and modify a table.

#### Listing 41.9 TestTableEditor.java

```

<margin note line 8: drives>
<margin note line 13: urls>
<margin note line 19: UI components>
<margin note line 29: create UI>
<margin note line 60: load driver>
<margin note line 61: create rowSet>
<margin note line 62: set url>
<margin note line 63: set username>
<margin note line 64: set password>
<margin note line 65: set command>
<margin note line 67: execute command>
<margin note line 69: rowSet to tableEditor1>
<margin note line 77: main method omitted>

import javax.swing.*;
import java.awt.*;
import java.awt.event.*;
import javax.sql.RowSet;
import com.sun.rowset.CachedRowSetImpl;

public class TestTableEditor extends JApplet {
 private JComboBox jcboDriver = new JComboBox(new String[] {
 "sun.jdbc.odbc.JdbcOdbcDriver",
 "com.mysql.jdbc.Driver",
 "oracle.jdbc.driver.OracleDriver"
 });
 private JComboBox jcboURL = new JComboBox(new String[] {
 "jdbc:odbc:exampleMDBDataSource",
 "jdbc:mysql://localhost/javabook",
 "jdbc:oracle:thin:@liang.armstrong.edu:1521:orcl"
 });

 private JButton jbtConnect =
 new JButton("Connect to DB & Get Table");
 private JTextField jtfxUserName = new JTextField();
 private JPasswordField jpfPassword = new JPasswordField();
 private JTextField jtfxTableName = new JTextField();
 private TableEditor tableEditor1 = new TableEditor();
 private JLabel jlblStatus = new JLabel();

 /** Creates new form TestTableEditor */
 public TestTableEditor() {
 JPanel jPanel1 = new JPanel(new GridLayout(5, 0));
 jPanel1.add(jcboDriver);

```

```

jPanel1.add(jcboURL);
jPanel1.add(jtfUserName);
jPanel1.add(jpfPassword);
jPanel1.add(jtfTableName);

JPanel jPanel2 = new JPanel(new GridLayout(5, 0));
jPanel2.add(new JLabel("JDBC Driver"));
jPanel2.add(new JLabel("Database URL"));
jPanel2.add(new JLabel("Username"));
jPanel2.add(new JLabel("Password"));
jPanel2.add(new JLabel("Table Name"));

JPanel jPanel3 = new JPanel(new BorderLayout());
jPanel3.add(jbtConnect, BorderLayout.SOUTH);
jPanel3.add(jPanel2, BorderLayout.WEST);
jPanel3.add(jPanel1, BorderLayout.CENTER);
tableEditor1.setPreferredSize(new Dimension(400, 200));

jcboURL.setEditable(true);
jcboDriver.setEditable(true);

add(new JSplitPane(JSplitPane.HORIZONTAL_SPLIT,
jPanel3, tableEditor1), BorderLayout.CENTER);
add(jlblStatus, BorderLayout.SOUTH);

jbtConnect.addActionListener(new ActionListener() {
public void actionPerformed(ActionEvent evt) {
try {
// Connect to the database and create a rowset
Class.forName(((String)jcboDriver.getSelectedItem()).trim());
RowSet rowSet = new CachedRowSetImpl();
rowSet.setUrl(((String)jcboURL.getSelectedItem()).trim());
rowSet.setUsername(jtfUserName.getText().trim());
rowSet.setPassword(new String(jpfPassword.getPassword()));
rowSet.setCommand("select * from " +
jtfTableName.getText().trim());
rowSet.execute();
rowSet.beforeFirst();
tableEditor1.setRowSet(rowSet);
}
catch (Exception ex) {
jlblStatus.setText(ex.toString());
}
}
});
}
}

```

When the user clicks the *Connect to DB & Get Table* button, a *CachedRowSet* is created (line 61). The url, username, password, and a command are set in the row set (lines 62-66). The row set is executed (line 67) and is plugged to the *TableEditor* (line 69).

#### Listing 41.10 TableEditor.java

```

<margin note line 10: UI components>
<margin note line 19: RowSetTableModel>
<margin note line 21: selection model>
<margin note line 22: JTable>
<margin note line 23: rowSet>
<margin note line 28: plug rowSet>
<margin note line 29: plug tableModel>
<margin note line 32: auto sort>
<margin note line 39: create UI>
<margin note line 53: plug selection model>
<margin note line 58: move cursor>
<margin note line 63: move cursor>
<margin note line 68: move cursor>
<margin note line 73: move cursor>
<margin note line 68: delete row>
<margin note line 84: save changes>
<margin note line 104: delete row>
<margin note line 117: synchronize table cursor>
<margin note line 124: move cursor>
<margin note line 142: table cursor selection>
import javax.swing.*;
import javax.swing.table.*;
import javax.swing.event.*;
import java.awt.*;
import java.awt.event.*;
import javax.sql.*;
import com.sun.rowset.CachedRowSetImpl;

public class TableEditor extends JPanel {
 private JButton jbtFirst = new JButton("First");
 private JButton jbtNext = new JButton("Next");
 private JButton jbtPrior = new JButton("Prior");
 private JButton jbtLast = new JButton("Last");
 private JButton jbtDelete = new JButton("Delete");
 private JButton jbtCommit = new JButton("Commit");
 private JLabel jlblStatus = new JLabel();

 // Table model, table selection model, table, rowset
 private RowSetTableModel tableModel = new RowSetTableModel();
 private DefaultListSelectionModel listSelectionModel =
 new DefaultListSelectionModel();
 private JTable jTable1 = new JTable();
 private RowSet rowSet;

 /** Set a new row set */
 public void setRowSet(RowSet rowSet) {
 this.rowSet = rowSet;
 tableModel.setRowSet(rowSet);
 jTable1.setModel(tableModel);

 // Enable auto sort on columns
 TableRowSorter<TableModel> sorter =
 new TableRowSorter<TableModel>(tableModel);
 jTable1.setRowSorter(sorter);

```



```

 }

 /** Create a TableEditor */
 public TableEditor() {
 JPanel jPanel1 = new JPanel();
 jPanel1.add(jbtFirst);
 jPanel1.add(jbtNext);
 jPanel1.add(jbtPrior);
 jPanel1.add(jbtLast);
 jPanel1.add(jbtDelete);
 jPanel1.add(jbtCommit);

 setLayout(new BorderLayout());
 add(jPanel1, BorderLayout.NORTH);
 add(new JScrollPane(jTable1), BorderLayout.CENTER);
 add(jlblStatus, BorderLayout.SOUTH);

 // Set selection model for the table
 jTable1.setSelectionModel(listSelectionModel);

 // Register listeners
 jbtFirst.addActionListener(new ActionListener() {
 public void actionPerformed(ActionEvent evt) {
 moveCursor("first");
 }
 });
 jbtNext.addActionListener(new ActionListener() {
 public void actionPerformed(ActionEvent evt) {
 moveCursor("next");
 }
 });
 jbtPrior.addActionListener(new ActionListener() {
 public void actionPerformed(ActionEvent evt) {
 moveCursor("previous");
 }
 });
 jbtLast.addActionListener(new ActionListener() {
 public void actionPerformed(ActionEvent evt) {
 moveCursor("last");
 }
 });
 jbtDelete.addActionListener(new ActionListener() {
 public void actionPerformed(ActionEvent evt) {
 delete();
 }
 });
 jbtCommit.addActionListener(new ActionListener() {
 public void actionPerformed(ActionEvent evt) {
 try {
 ((CachedRowSetImpl) rowSet).acceptChanges();
 }
 catch (java.sql.SQLException ex) {
 ex.printStackTrace();
 }
 }
 });
 }
}

```

```

 }
 });
 listSelectionModel.addListSelectionListener(
 new ListSelectionListener() {
 public void valueChanged(ListSelectionEvent e) {
 handleSelectionValueChanged(e);
 }
 });
}

/* Delete a row */
private void delete() {
 try {
 // Delete the record from the database
 int currentRow = rowSet.getRow();
 rowSet.deleteRow();
 if (rowSet.isAfterLast())
 rowSet.last();
 else if (rowSet.getRow() >= currentRow)
 rowSet.absolute(currentRow);
 setTableCursor();
 }
 catch (java.sql.SQLException ex) {
 lblStatus.setText(ex.toString());
 }
}

/** Set cursor in the table and set the row number in the status */
private void setTableCursor() throws java.sql.SQLException {
 int row = rowSet.getRow();
 listSelectionModel.setSelectionInterval(row - 1, row - 1);
 lblStatus.setText("Current row number: " + row);
}

/** Move cursor to the specified location */
private void moveCursor(String whereToMove) {
 try {
 if (whereToMove.equals("first"))
 rowSet.first();
 else if (whereToMove.equals("next") && !rowSet.isLast())
 rowSet.next();
 else if (whereToMove.equals("previous") && !rowSet.isFirst())
 rowSet.previous();
 else if (whereToMove.equals("last"))
 rowSet.last();
 setTableCursor();
 }
 catch (java.sql.SQLException ex) {
 lblStatus.setText(ex.toString());
 }
}

/** Handle the selection in the table */
private void handleSelectionValueChanged(ListSelectionEvent e) {

```

```

 int selectedRow = jTable1.getSelectedRow();

 try {
 if (selectedRow != -1) {
 rowSet.absolute(selectedRow + 1);
 setTableCursor();
 }
 }
 catch (java.sql.SQLException ex) {
 lblStatus.setText(ex.toString());
 }
 }
}

```

The `setRowSet` method (lines 26-35) sets a new row set in `TableEditor`. The `rowSet` is plugged into the table model (line 29) and the table model is attached to the table (line 32). The code in lines 32-34 enables the column names to be sorted.

The handling of the navigation buttons *First*, *Next*, *Prior*, and *Last* is simply to invoke the methods `first()`, `next()`, `previous()`, and `last()` to move the cursor in the `rowSet` and (lines 126-133), at the same time, set the selected row in `JTable` by invoking `setTableCursor()` (line 134).

To implement the *Delete* button, invoke the `deleteRow()` method (line 104) to remove the row from the `rowSet`. After the row is removed, set the cursor to the next row in the `rowSet` (lines 105-108) and synchronize the cursor in the table (line 109).

Note that the `deleteRow()` method removes the row from the `CachedRowSet`. The *Commit* button actually saves the changes into the database (line 84).

To implement the handler for list-selection events on `jTable1`, set the cursor in the row set to match the row selected in `jTable1` (lines 142-154).

#### 41.7 Storing and Retrieving Images in JDBC

A database can store not only numbers and strings, but also images. SQL3 introduced a new data type called BLOB (Binary Large Object) for storing binary data, which can be used to store images. Another new SQL3 type is CLOB (Character Large Object) for storing a large text in the character format. JDBC introduced the interfaces `java.sql.Blob` and `java.sql.Clob` to support mapping for these new SQL types. You can use `getBlob`, `setBinaryStream`, `getClob`, `setBlob`, and `setClob`, to access SQL BLOB and CLOB values in the interfaces `ResultSet` and `PreparedStatement`.

To store an image into a cell in a table, the corresponding column for the cell must be of the BLOB type. For example, the following SQL statement creates a table whose type for the flag column is BLOB.

```

create table Country(name varchar(30), flag blob,
description varchar(255));

```

In the preceding statement, the `description` column is limited to 255 characters, which is the upper limit for MySQL. For Oracle, the upper limit is 32,672 bytes. For a large character field, you can use the CLOB type for Oracle, which can store up to two GB characters. MySQL does not support CLOB. However, you can use BLOB to store a long string and convert binary data into characters.

NOTE

**<margin note: supported?>**

Access does not support the BLOB and CLOB types.

To insert a record with images to a table, define a prepared statement like this one:

```
PreparedStatement pstmt = connection.prepareStatement(
 "insert into Country values(?, ?, ?)");
```

**<margin note: store image>**

Images are usually stored in files. You may first get an instance of `InputStream` for an image file and then use the `setBinaryStream` method to associate the input stream with a cell in the table, as follows:

```
// Store image to the table cell
File file = new File(imageFilename);
InputStream inputImage = new FileInputStream(file);
pstmt.setBinaryStream(2, inputImage, (int)file.length());
```

**<margin note: retrieve image>**

To retrieve an image from a table, use the `getBlob` method, as shown below:

```
// Store image to the table cell
Blob blob = rs.getBlob(1);
ImageIcon imageIcon = new ImageIcon(
 blob.getBytes(1, (int)blob.length()));
```

Listing 41.11 gives a program that demonstrates how to store and retrieve images in JDBC. The program first creates the `Country` table and stores data to it. Then the program retrieves the country names from the table and adds them to a combo box. When the user selects a name from the combo box, the country's flag and description are displayed, as shown in Figure 41.5.



**Figure 41.5**

*The program enables you to retrieve data, including images, from a table and displays them.*

**Listing 41.11 StoreAndRetrieveImage.java**

<margin note line 45: load driver>  
 <margin note line 49: connect database>  
 <margin note line 54: create statement>  
 <margin note line 57: prepare statement>  
 <margin note line 62: data to database>  
 <margin note line 75: insert>  
 <margin note line 83: get image URL>  
 <margin note line 86: binary stream>  
 <margin note line 103: fill combo box>  
 <margin note line 109: set name>  
 <margin note line 113: get image icon>  
 <margin note line 118: set description>  
 <margin note line 125: main method omitted>

```

import java.sql.*;
import java.io.*;
import javax.swing.*;
import java.awt.*;
import java.awt.event.*;

public class StoreAndRetrieveImage extends JApplet {
 // Connection to the database
 private Connection connection;

 // Statement for static SQL statements
 private Statement stmt;

 // Prepared statement
 private PreparedStatement pstmt = null;
 private DescriptionPanel descriptionPanell
 = new DescriptionPanel();

 private JComboBox jcboCountry = new JComboBox();

 /** Creates new form StoreAndRetrieveImage */
 public StoreAndRetrieveImage() {
 try {
 connectDB(); // Connect to DB
 storeDataToTable(); //Store data to the table (including image)
 fillDataInComboBox(); // Fill in combo box
 retrieveFlagInfo((String)jcboCountry.getSelectedItem());
 }
 catch (Exception ex) {
 ex.printStackTrace();
 }

 jcboCountry.addItemListener(new ItemListener() {
 public void itemStateChanged(ItemEvent evt) {
 retrieveFlagInfo((String) (evt.getItem()));
 }
 });

 add(jcboCountry, BorderLayout.NORTH);
 add(descriptionPanell, BorderLayout.CENTER);
 }

 private void connectDB() throws Exception {
 // Load the driver

```

```

Class.forName("com.mysql.jdbc.Driver");
System.out.println("Driver loaded");

// Establish connection
connection = DriverManager.getConnection
("jdbc:mysql://localhost/javabook", "scott", "tiger");
System.out.println("Database connected");

// Create a statement for static SQL
stmt = connection.createStatement();

// Create a prepared statement to retrieve flag and description
pstmt = connection.prepareStatement("select flag, description " +
"from Country where name = ?");
}

private void storeDataToTable() {
String[] countries = {"Canada", "UK", "USA", "Germany",
"Indian", "China"};

String[] imageFileNames = {"image/ca.gif", "image/uk.gif",
"image/us.gif", "image/germany.gif", "image/india.gif",
"image/china.gif"};

String[] descriptions = {"A text to describe Canadian " +
"flag is omitted", "British flag ...", "American flag ...",
"German flag ...", "Indian flag ...", "Chinese flag ..."};

try {
// Create a prepared statement to insert records
PreparedStatement pstmt = connection.prepareStatement(
"insert into Country values(?, ?, ?)");

// Store all predefined records
for (int i = 0; i < countries.length; i++) {
pstmt.setString(1, countries[i]);

// Store image to the table cell
java.net.URL url =
this.getClass().getResource(imageFileNames[i]);
InputStream inputImage = url.openStream();
pstmt.setBinaryStream(2, inputImage,
(int) inputImage.available());

pstmt.setString(3, descriptions[i]);
pstmt.executeUpdate();
}

System.out.println("Table Country populated");
}
catch (Exception ex) {
ex.printStackTrace();
}
}

private void fillDataInComboBox() throws Exception {
ResultSet rs = stmt.executeQuery("select name from Country");
while (rs.next()) {
jcbCountry.addItem(rs.getString(1));
}
}

```

```

 }

 private void retrieveFlagInfo(String name) {
 try {
 pstmt.setString(1, name);
 ResultSet rs = pstmt.executeQuery();
 if (rs.next()) {
 Blob blob = rs.getBlob(1);
 ImageIcon imageIcon = new ImageIcon(
 blob.getBytes(1, (int)blob.length()));
 descriptionPanell.setImageIcon(imageIcon);
 descriptionPanell.setName(name);
 String description = rs.getString(2);
 descriptionPanell.setDescription(description);
 }
 }
 catch (Exception ex) {
 System.err.println(ex);
 }
 }
}

```

`DescriptionPanel` (line 14) is a component for displaying a country (name, flag, and description). This component was presented in Listing 17.2, `DescriptionPanel.java`.

The `storeDataToTable` method (lines 58-95) populates the table with data. The `fillDataInComboBox` method (lines 97-102) retrieves the country names and adds them to the combo box. The `retrieveFlagInfo(name)` method (lines 104-121) retrieves the flag and description for the specified country name.

### Key Terms

- **BLOB type**
- **CLOB type**
- **batch mode**
- **cached row set**
- **row set**
- **scrollable result set**
- **updatable result set**

### Chapter Summary

1. This chapter developed a universal SQL client that can be used to access any local or remote relational database.
2. You can use the `addBatch(SQLString)` method to add SQL statements to a statement for batch processing.
3. You can create a statement to specify that the result set be scrollable and updatable. By default, the result set is neither of these.
4. The `RowSet` can be used to simplify Java database programming. A `RowSet` object is scrollable and updatable. A `RowSet` can fire a `RowSetEvent`.
5. You can store and retrieve image data in JDBC using the SQL BLOB type.

## Test Questions

Do the test questions for this chapter online at  
[www.cs.armstrong.edu/liang/intro9e/test.html](http://www.cs.armstrong.edu/liang/intro9e/test.html).

## Review Questions

### Section 41.3

41.1 What is batch processing in JDBC? What are the benefits of using batch processing?

41.2 How do you add an SQL statement to a batch? How do you execute a batch?

41.3 Can you execute a SELECT statement in a batch?

41.4 How do you know whether a JDBC driver supports batch updates?

### Section 41.4

41.5 What is a scrollable result set? What is an updatable result set?

41.6 How do you create a scrollable and updatable ResultSet?

41.7 How do you know whether a JDBC driver supports a scrollable and updatable ResultSet?

### Sections 41.5-41.6

41.8 What are the advantages of RowSet?

41.9 What are JdbcRowSet and CachedRowSet? What are the differences between them?

41.10 How do you create a JdbcRowSet and a CachedRowSet?

41.11 Can you scroll and update a RowSet? What method must be invoked to write the changes in a CachedRowSet to the database?

41.12 Describe the handlers in RowSetListener.

### Section 41.7

41.13 How do you store images into a database?

41.14 How do you retrieve images from a database?

41.15 Does Oracle support the SQL3 BLOB type and CLOB type? What about MySQL and Access?

## Exercises

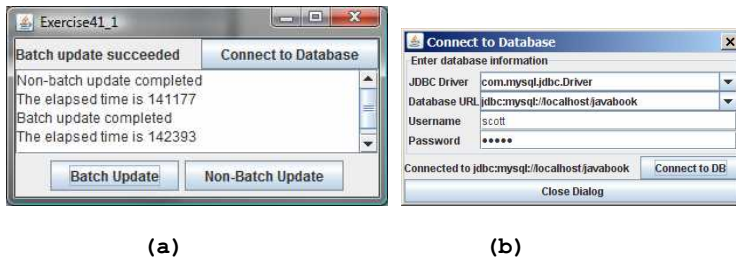
### 41.1\*

(Batch update) Write a program that inserts a thousand records to a database, and compare the performance with and without batch updates, as shown in Figure 41.6a. Suppose the table is defined as follows:

```
create table Temp(num1 double, num2 double, num3 double)
```



Use the `Math.random()` method to generate random numbers for each record. Create a dialog box that contains `DBConnectionPanel`, discussed in Exercise 37.3. Use this dialog box to connect to the database. When you click the *Connect to Database* button in Figure 41.6a, the dialog box in Figure 41.6b is displayed.

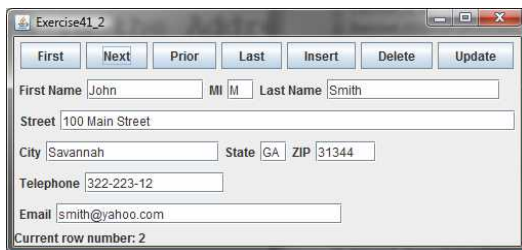


**Figure 41.6**

The program demonstrates the performance improvements that result from using batch updates.

41.2\*\*

(*Scrollable result set*) Write a program that uses the buttons *First*, *Next*, *Prior*, *Last*, *Insert*, *Delete*, and *Update*, and modify a single record in the Address table, as shown in Figure 41.7.



**Figure 41.7**

You can use the buttons to display and modify a single record in the Address table.

41.3\*\*

(*ResultSetTableModel*) Listing 41.8, `RowSetTableModel.java`, defines a table model for `RowSet`. Develop a new class named `ResultSetTableModel` for `ResultSet`. `ResultSetTableModel` extends `AbstractTableModel`. Write a test program that displays the Course table to a `JTable`, as shown in Figure 41.8. Enable autosort on columns.

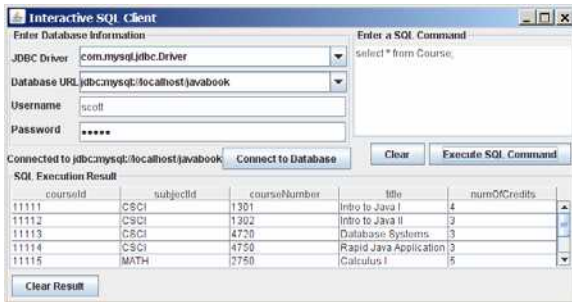
courseId	subjectId	courseNumber	title	numOfCredits
11111	CSCI	1301	Introduction to Java I	4
11112	CSCI	1302	Intro to Java II	3
11113	CSCI	4720	Database Systems	3
11114	CSCI	4750	Rapid Java Application	3
11115	MATH	2750	Calculus I	5
11116	MATH	3750	Calculus II	5
11117	EDUC	1111	Reading	3
11118	ITEC	1344	Database Administration	3

**Figure 41.8**

The Course table is displayed in a JTable using ResultSetTableModel.

41.4\*\*

(Revise SQLClient.java) Rewrite Listing 41.1, SQLClient.java, to display the query result in a JTable, as shown in Figure 41.9.



**Figure 41.9**

The query result is displayed in a JTable.

41.5\*\*\*

(Edit table using RowSet) Rewrite Listing 41.10 to add an Insert button to insert a new row and an Update button to update the row.

41.6\*

(Display images from database) Write a program that uses JTable to display the Country table created in Listing 41.11, StoreAndRetrieveImage.java, as shown in Figure 41.10.

Name	Flag	Description
Canada		A text to describe Canadian fla...
UK		British flag ...
USA		American flag ...

**Figure 41.10**

The Country table is displayed in a JTable instance.

41.7\*\*

(Store and retrieve images using RowSet) Rewrite the example in Listing 41.11, StoreAndRetrieveImage.java, using RowSet.

41.8\*

(Populate Salary table) Rewrite Exercise 33.8 using a batch mode to improve performance.

*\*\*\*This is a bonus Web chapter*

## **CHAPTER 42**

### **Servlets**

#### Objectives

- To explain how a servlet works (§42.2).
- To create/develop/run servlets (§42.3).
- To deploy servlets on application servers such as Tomcat and GlassFish (§42.3).
- To describe the servlets API (§42.4).
- To create simple servlets (§42.5).
- To create and process HTML forms (§42.6).
- To develop servlets to access databases (§42.7).
- To use hidden fields, cookies, and HttpSession to track sessions (§42.8).
- To send images from servlets (§42.9).

## 42.1 Introduction

### <Side Remark: servlet>

Servlets are Java programs that run on a Web server. They can be used to process client requests or produce dynamic Web pages. For example, you can write servlets to generate dynamic Web pages that display stock quotes or process client registration forms and store registration data in a database. This chapter introduces the concept of Java servlets. You will learn how to develop Java servlets using NetBeans.

NOTE:

### <Side Remark: why NetBeans?>

You can develop servlets without using an IDE. However, using an IDE such as NetBeans can greatly simplify the development task. The tool can automatically create the supporting directories and files. We choose NetBeans because it has the best support for Java Web development. You can still use your favorite IDE or no IDE for this chapter.

NOTE:

### <Side Remark: why servlets?>

Servlets are the foundation of Java Web technologies. JSP, JSF, and Java Web services are based on servlets. A good understanding of servlets helps you see the big picture of Java Web technology and learn JSP, JSF, and Web services.

## 42.2 HTML and Common Gateway Interface

Java servlets run in the Web environment. To understand Java servlets, let us review HTML and the Common Gateway Interface (CGI).

### 42.2.1 Static Web Contents

You create Web pages using HTML. Your Web pages are stored as files on the Web server. The files are usually stored in the /htdocs directory on Unix, as shown in Figure 42.1. A user types a URL for the file from a Web browser. The browser contacts the Web server and requests the file. The server finds the file and returns it to the browser. The browser then displays the file to the user. This works fine for static information that does not change regardless of who requests it or when it is requested. Static information is stored in files. The information in the files can be updated, but at any given time every request for the same document returns exactly the same result.

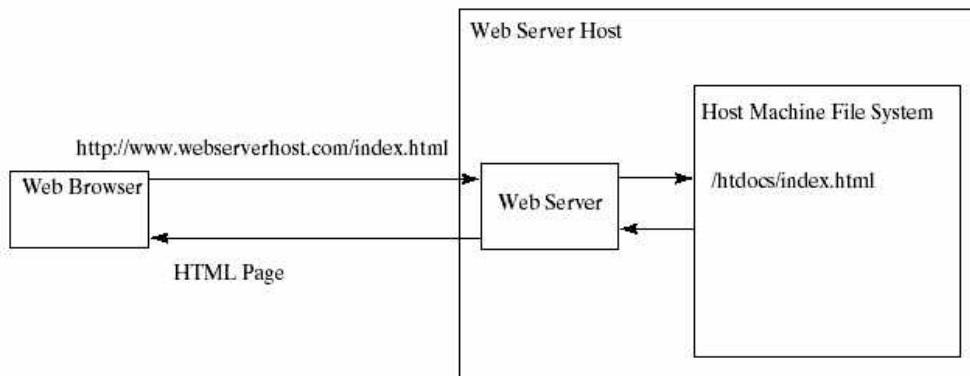


Figure 42.1

A Web browser requests a static HTML page from a Web server.

#### 42.2.2 Dynamic Web Contents and Common Gateway Interface

Not all information, however, is static in nature. Stock quotes are updated whenever a trade takes place. Election vote counts are updated constantly on Election Day. Weather reports are frequently updated. The balance in a customer's bank account is updated whenever a transaction takes place. To view up-to-date information on the Web, the HTML pages for displaying this information must be generated dynamically. Dynamic Web pages are generated by Web servers. The Web server needs to run certain programs to process user requests from Web browsers in order to produce a customized response.

##### <Side Remark: CGI>

The *Common Gateway Interface*, or *CGI*, was proposed to generate dynamic Web content. The interface provides a standard framework for Web servers to interact with external programs, known as *CGI programs*. As shown in Figure 42.2, the Web server receives a request from a Web browser and passes it to the CGI program. The CGI program processes the request and generates a response at runtime. CGI programs can be written in any language, but the *Perl* language is the most popular choice. CGI programs are typically stored in the `/cgi-bin` directory. Here is a pseudocode example of a CGI program for displaying a customer's bank account balance:

1. Obtain account ID and password.
2. Verify account ID and password. If it fails, generate an HTML page to report incorrect account ID and password, and exit.
3. Retrieve account balance from the database; generate an HTML page to display the account ID and balance.

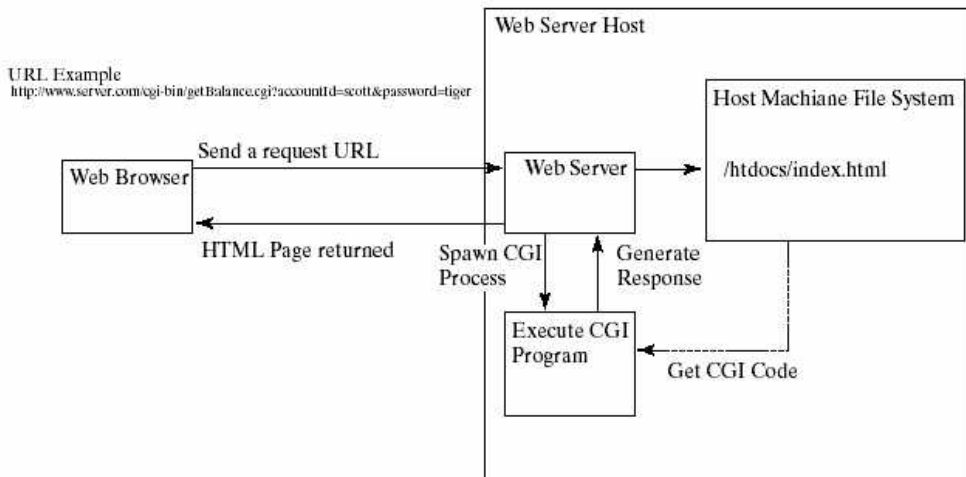


Figure 42.2

A Web browser requests a dynamic HTML page from a Web server.

#### 42.2.3 The GET and POST Methods

**<Side Remark: query string>**

The two most common HTTP requests, also known as *methods*, are GET and POST. The Web browser issues a request using a URL or an HTML form to trigger the Web server to execute a CGI program. HTML forms will be introduced in §42.6, "HTML Forms." When issuing a CGI request directly from a URL, the GET method is used. This URL is known as a *query string*. The URL query string consists of the location of the CGI program, the parameters, and their values. For example, the following URL causes the CGI program `getBalance` to be invoked on the server side:

```
http://www.webserverhost.com/cgi-bin/
getBalance.cgi?accountId=scott+smith&password=tiger
```

The `?` symbol separates the program from the parameters. The parameter name and value are associated using the `=` symbol. Parameter pairs are separated using the `&` symbol. The `+` symbol denotes a space character. So, here `accountId` is `scott smith`.

When issuing a request from an HTML form, either a GET method or a POST method can be used. The form explicitly specifies one of these. If the GET method is used, the data in the form are appended to the request string as if it were submitted using a URL. If the POST method is used, the data in the form are packaged as part of the request file. The server program obtains the data by reading the file. The POST method is more secure than the GET method.

NOTE

**<Side Remark: GET vs. POST>**

The GET and POST methods both send requests to the Web server. The POST method always triggers the execution of the corresponding CGI program. The GET method may not cause the CGI program to be executed, if the previous same request is cached in the Web browser. Web browsers often cache Web pages so that the same request can be quickly responded to without contacting the Web server. The browser checks the request sent through the GET method as a URL query string. If the results for the exact same URL are cached on a disk, then the previous Web pages for the URL may be displayed. To ensure that a new Web page is always displayed, use the POST method. For example, use a POST method if the request will actually update the database. If your request is not time sensitive, such as finding the address of a student in the database, use the GET method to speed up performance.

#### 42.2.4 From CGI to Java Servlets

**<Side Remark: CGI vs. servlets>**

CGI provides a relatively simple approach for creating dynamic Web applications that accept a user request, process it on the server side, and return responses to the Web browser. But CGI is very slow when handling a large number of requests simultaneously, because the Web server spawns a process for executing each CGI program. Each process has its own runtime environment that contains and runs the CGI program. It is not difficult to imagine what will happen if many CGI programs were executed simultaneously. System resource would be quickly exhausted, potentially causing the server to crash.

**<Side Remark: servlet engine>**

Several new approaches have been developed to remedy the performance problem of CGI programs. Java servlets are one successful technology for

this purpose. Java servlets are Java programs that function like CGI programs. They are executed upon request from a Web browser. All servlets run inside a *servlet container*, also referred to as a *servlet server* or a *servlet engine*. A servlet container is a single process that runs in a Java Virtual Machine. The JVM creates a thread to handle each servlet. Java threads have much less overhead than full-blown processes. All the threads share the same memory allocated to the JVM. Since the JVM persists beyond the life cycle of a single servlet execution, servlets can share objects already created in the JVM. For example, if multiple servlets access the same database, they can share the connection object. Servlets are much more efficient than CGI.

Servlets have other benefits that are inherent in Java. As Java programs, they are object oriented, portable, and platform independent. Since you know Java, you can develop servlets immediately with the support of Java API for accessing databases and network resources.

### 42.3 Creating and Running Servlets

<side remark: Tomcat>

<side remark: GlassFish>

To run Java servlets, you need a servlet container. Many servlet containers are available for free. Two popular ones are *Tomcat* (developed by Apache, [www.apache.org](http://www.apache.org)) and *GlassFish* (developed by Sun, [glassfish.dev.java.net](http://glassfish.dev.java.net)). Both Tomcat and GlassFish are bundled and integrated with NetBeans 7 (Java EE version). When you run a servlet from NetBeans, Tomcat or GlassFish will be automatically started. You can choose to use either of them, or any other application server. GlassFish has more features than Tomcat and it takes more system resource.

#### 42.3.1 Creating a Servlet

Before our introduction to the servlet API, let us look at a simple example to see how servlets work. A servlet to some extent resembles an applet. Every Java applet is a subclass of the `Applet` class. You need to override appropriate methods in the `Applet` class to implement the applet. Every servlet is a subclass of the `HttpServlet` class. You need to override appropriate methods in the `HttpServlet` class to implement the servlet. Listing 42.1 is a servlet that generates a response in HTML using the `doGet` method.

Listing 42.1 FirstServlet.java

<Side Remark line 11: process GET>

<Side Remark line 14: content type>

<Side Remark line 15: output to browser>

<Side Remark line 25: close stream>

```
package chapter42;

import javax.servlet.*;
import javax.servlet.http.*;

public class FirstServlet extends HttpServlet {
 /** Handle the HTTP GET method.
 * @param request servlet request
 * @param response servlet response
 */
 protected void doGet(HttpServletRequest request,
```



```

 HttpServletResponse response)
 throws ServletException, java.io.IOException {
 response.setContentType("text/html");
 java.io.PrintWriter out = response.getWriter();
 // output your page here
 out.println("<html>");
 out.println("<head>");
 out.println("<title>Servlet</title>");
 out.println("</head>");
 out.println("<body>");
 out.println("Hello, Java Servlets");
 out.println("</body>");
 out.println("</html>");
 out.close();
 }
}

```

<Side Remark: request>

<Side Remark: response>

<Side Remark: PrintWriter>

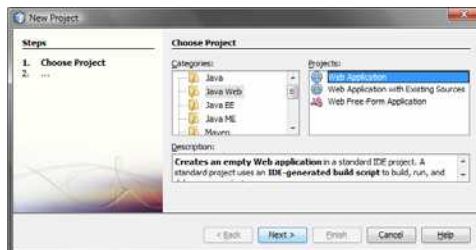
The `doGet` method (line 11) is invoked when the Web browser issues a request using the GET method. The `doGet` method has two parameters, `request` and `response`. `request` is for obtaining data from the Web browser and `response` is for sending data back to the browser. Line 14 indicates that data are sent back to the browser as text/html. Line 15 obtains an instance of `PrintWriter` for actually outputting data to the browser.

#### 42.3.2 Creating Servlets in NetBeans

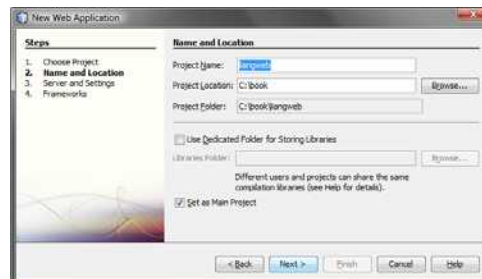
<Side Remark: create a Web project>

NetBeans is updated frequently. The current version is 7.0 at the time of this writing. To create a servlet in NetBeans 7, you have to first create a Web project, as follows:

1. Choose **File > New Project** to display the New Project dialog box. Choose **Java Web** in the Categories section and **Web Application** in the Projects section, as shown in Figure 42.3a. Click *Next* to display the New Web Application dialog box, as shown in Figure 42.3b.
2. Enter `liangweb` in the Project Name field and `c:\book` in the Project Location field. Check Set as Main Project. Click *Next* to display the dialog box for specifying server and settings, as shown in Figure 42.4.
3. Select `Apache Tomcat 7.0.11` for server and `Java EE 5` for J2EE Version. Click *Finish* to create the Web project, as shown in Figure 42.5.



(a)



(b)

Figure 42.3

(a) Choose Web Application to create a Web project. (b) Specify project name and location.

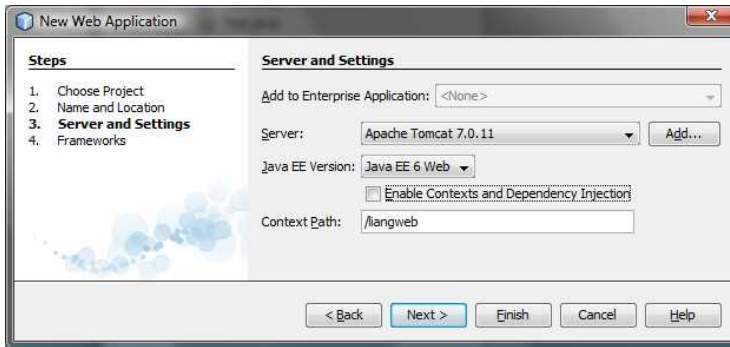


Figure 42.4

Choose servers and settings.

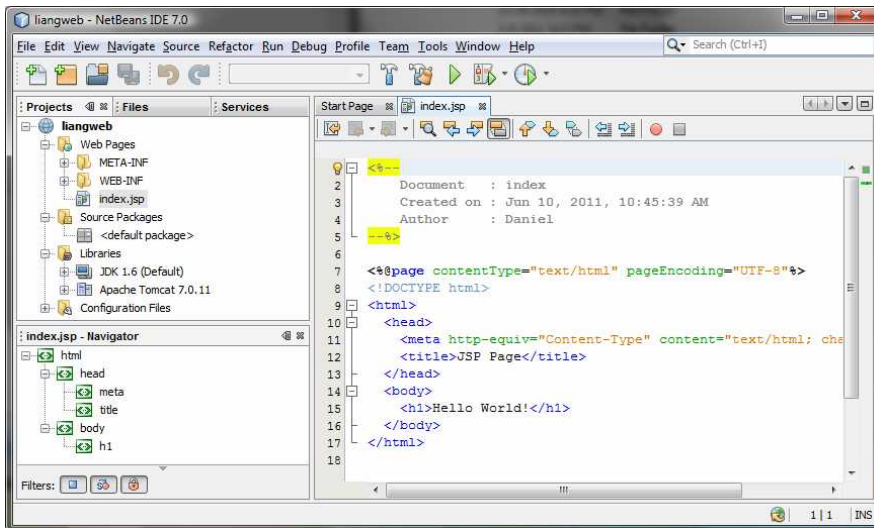


Figure 42.5

A new Web project is created.

Now you can create a servlet in the project, as follows:

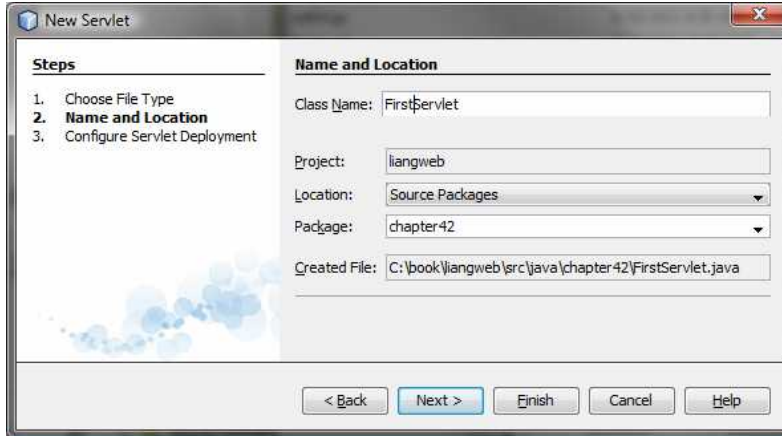
**<Side Remark: create a servlet>**

1. Right-click the liangweb node in the project pane to display a context menu. Choose **New > Servlet** to display the New Servlet dialog box, as shown in Figure 42.6.
2. Enter `FirstServlet` in the Class Name field and `chapter42` in the Package field and click `Next` to display the Configure Servlet Deployment dialog box, as shown in Figure 42.7.

3. Select the checkbox to add the servlet information to web.xml and click *Finish* to create the servlet. A servlet template is now created in the project, as shown in Figure 42.8.
4. Replace the code in the content pane for the servlet using the code in Listing 42.1.

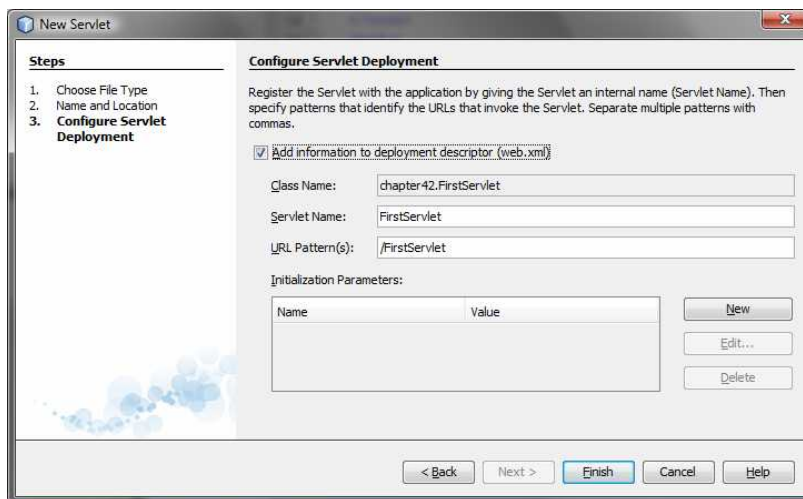
**<Side Remark: run a servlet>**

5. Right-click `liangweb` node in the Project pane to display a context menu and choose **Run** to launch the Web server. In the Web browser, enter <http://localhost:8084/liangweb/FirstServlet> in the URL. You will now see the servlet result displayed, as shown in Figure 42.9.



**Figure 42.6**

*You can create a servlet in the New Servlet dialog box.*



**Figure 42.7**

*You need to click the checkbox to add servlet information to web.xml.*

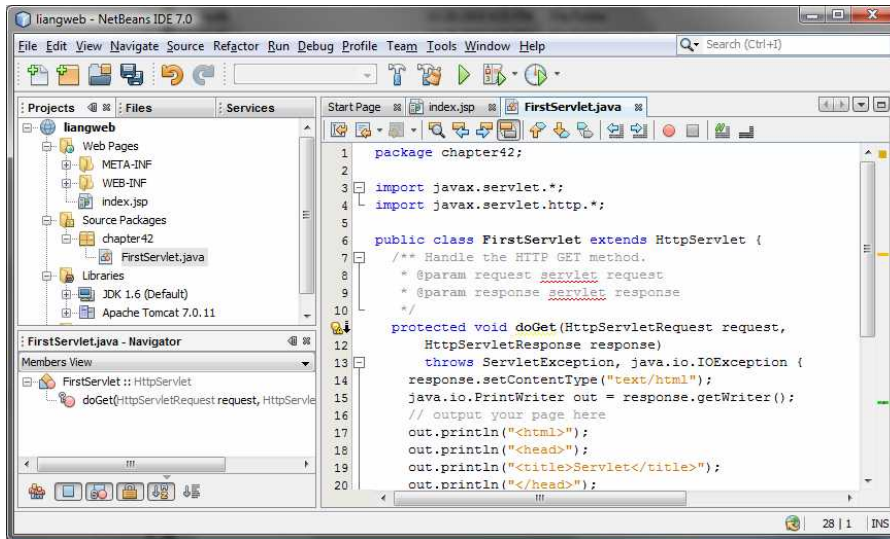


Figure 42.8

A new servlet class is created in the project.

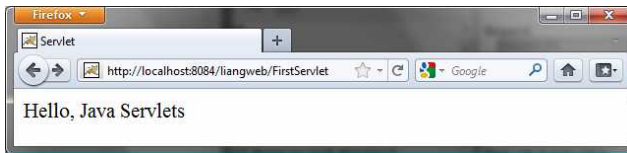


Figure 42.9

Servlet result is displayed in a Web browser.

NOTE

**<Side Remark: IDE issues>**

If the servlet is not displayed in the browser, do the following: 1. Make sure you have added the servlet in the xml.web file. 2. Right-click **liangweb** and choose *Clean and Build*. 3. Right-click **liangweb** and choose *Run*. Reenter

<http://localhost:8084/liangweb/FirstServlet> in the URL.

If still not working, exit NetBeans and restart it.

\*\*\*End of NOTE

NOTE

**<Side Remark: port number>**

Depending on the server setup, you may have a port number other than **8084**.

\*\*\*End of NOTE

TIP

**<Side Remark: deploy Web project>**

**<Side Remark: WAR file>**

You can deploy a Web application using a Web archive file (WAR) to a Web application server (e.g., Tomcat). To create a WAR file for the liangweb project, right-click liangweb and choose **Build Project**. You can now locate liangweb.war in the c:\book\liangweb\dist folder. To deploy on Tomcat, simply place liangweb.war into the webapps directory. When Tomcat starts, the .war file will be automatically installed.

NOTE:

<side remark: Tomcat Tutorial>

If you wish to use NetBeans as the development tool and Tomcat as the deployment server, please see Supplement V.E, "Tomcat Tutorial."

#### 42.4 The Servlet API

You have to know the servlet API in order to understand the source code in FirstServlet.java. The servlet API provides the interfaces and classes that support servlets. These interfaces and classes are grouped into two packages, `javax.servlet` and `javax.servlet.http`, as shown in Figure 42.10. The `javax.servlet` package provides basic interfaces, and the `javax.servlet.http` package provides classes and interfaces derived from them, which provide specific means for servicing HTTP requests.

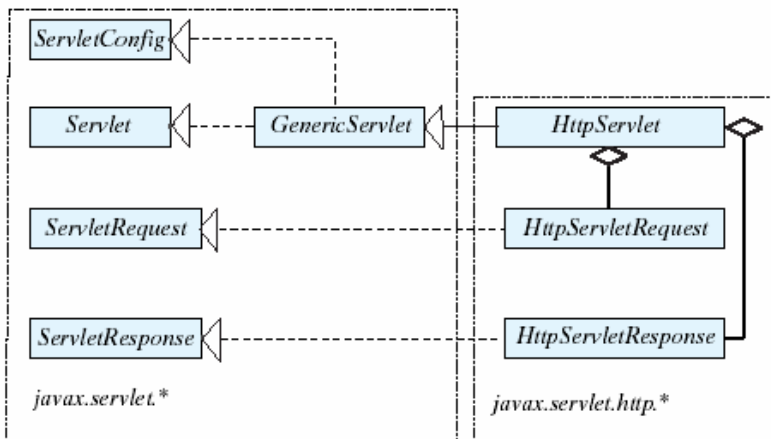


Figure 42.10

The servlet API contains interfaces and classes that you use to develop and run servlets.

##### 42.4.1 The Servlet Interface

The `javax.servlet.Servlet` interface defines the methods that all servlets must implement. The methods are listed below:

```

/** Invoked for every servlet constructed */
public void init() throws ServletException;

/** Invoked to respond to incoming requests */

```

```

public void service(ServletRequest request, ServletResponse
response)
 throws ServletException, IOException;

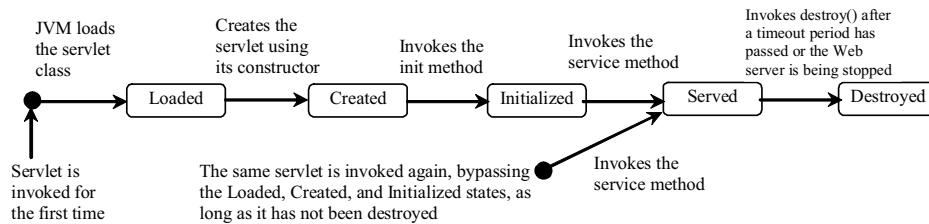
/** Invoked to release resource by the servlet */
public void destroy();

```

**<Side Remark: servlet life cycle>**

The `init`, `service`, and `destroy` methods are known as *life-cycle methods* and are called in the following sequence (see Figure 42.11):

1. The `init` method is called when the servlet is first created and is not called again as long as the servlet is not destroyed. This resembles an applet's `init` method, which is invoked after the applet is created and is not invoked again as long as the applet is not destroyed.
2. The `service` method is invoked each time the server receives a request for the servlet. The server spawns a new thread and invokes `service`.
3. The `destroy` method is invoked after a timeout period has passed or as the Web server is terminated. This method releases resources for the servlet.



**Figure 42.11**

The JVM uses the `init`, `service`, and `destroy` methods to control the servlet.

**42.4.2 The `GenericServlet` Class, `ServletConfig` Interface, and `HttpServlet` Class**

The `javax.servlet.GenericServlet` class defines a generic, protocol-independent servlet. It implements `javax.servlet.Servlet` and `javax.servlet.ServletConfig`. `ServletConfig` is an interface that defines four methods (`getInitParameter`, `getInitParameterNames`, `getServletContext`, and `getServletName`) for obtaining information from a Web server during initialization. All the methods in `Servlet` and `ServletConfig` are implemented in `GenericServlet` except `service`. Therefore, `GenericServlet` is an abstract class.

The `javax.servlet.http.HttpServlet` class defines a servlet for the HTTP protocol. It extends `GenericServlet` and implements the `service` method. The `service` method is implemented as a dispatcher of HTTP requests. The HTTP requests are processed in the following methods:

- `doGet` is invoked to respond to a GET request.
- `doPost` is invoked to respond to a POST request.
- `doDelete` is invoked to respond to a DELETE request. Such a request is normally used to delete a file on the server.

- **doPut** is invoked to respond to a PUT request. Such a request is normally used to send a file to the server.
- **doOptions** is invoked to respond to an OPTIONS request. This returns information about the server, such as which HTTP methods it supports.
- **doTrace** is invoked to respond to a TRACE request. Such a request is normally used for debugging. This method returns an HTML page that contains appropriate trace information.

All these methods use the following signature:

```
protected void doXxx(HttpServletRequest req, HttpServletResponse resp)
 throws ServletException, java.io.IOException
```

The `HttpServlet` class provides default implementation for these methods. You need to override `doGet`, `doPost`, `doDelete`, and `doPut` if you want the servlet to process a GET, POST, DELETE, or PUT request. By default, nothing will be done. Normally, you should not override the `doOptions` method unless the servlet implements new HTTP methods beyond those implemented by HTTP 1.1. Nor is there any need to override the `doTrace` method.

NOTE: GET and POST requests are often used, whereas DELETE, PUT, OPTIONS, and TRACE are not. For more information about these requests, please refer to the HTTP 1.1 specification from [www.cis.ohio-state.edu/htbin/rfc/rfc2068.html](http://www.cis.ohio-state.edu/htbin/rfc/rfc2068.html).

NOTE: Although the methods in `HttpServlet` are all nonabstract, `HttpServlet` is defined as an abstract class. Thus you cannot create a servlet directly from `HttpServlet`. Instead you have to define your servlet by extending `HttpServlet`.

The relationship of these interfaces and classes is shown in Figure 42.12.

<PD: UML Class Diagram>

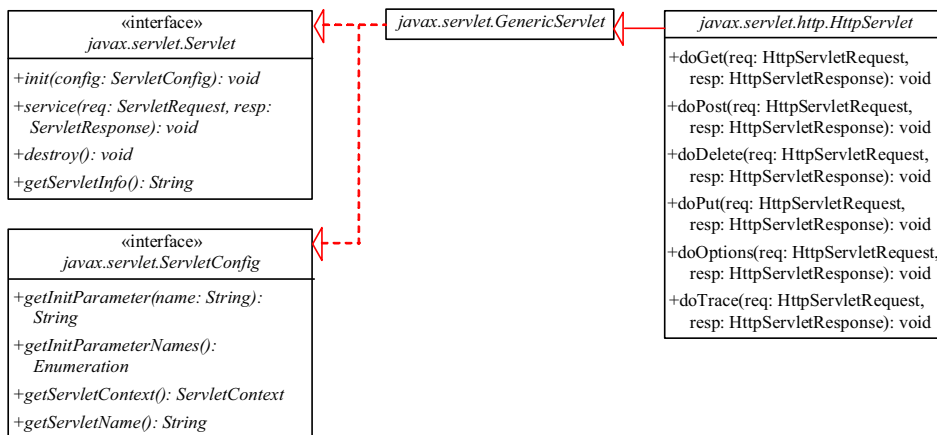


Figure 42.12

*HttpServletRequest* inherits abstract class *GenericServlet*, which implements interfaces *Servlet* and *ServletConfig*.

#### 42.4.3 The **ServletRequest** Interface and **HttpServletRequest** Interface

Every `doXxx` method in the *HttpServletRequest* class has a parameter of the *HttpServletRequest* type, which is an object that contains HTTP request information, including parameter name and values, attributes, and an input stream. *HttpServletRequest* is a subinterface of *ServletRequest*. *ServletRequest* defines a more general interface to provide information for all kinds of clients. The frequently used methods in these two interfaces are shown in Figure 42.13.

<PD: UML Class Diagram>

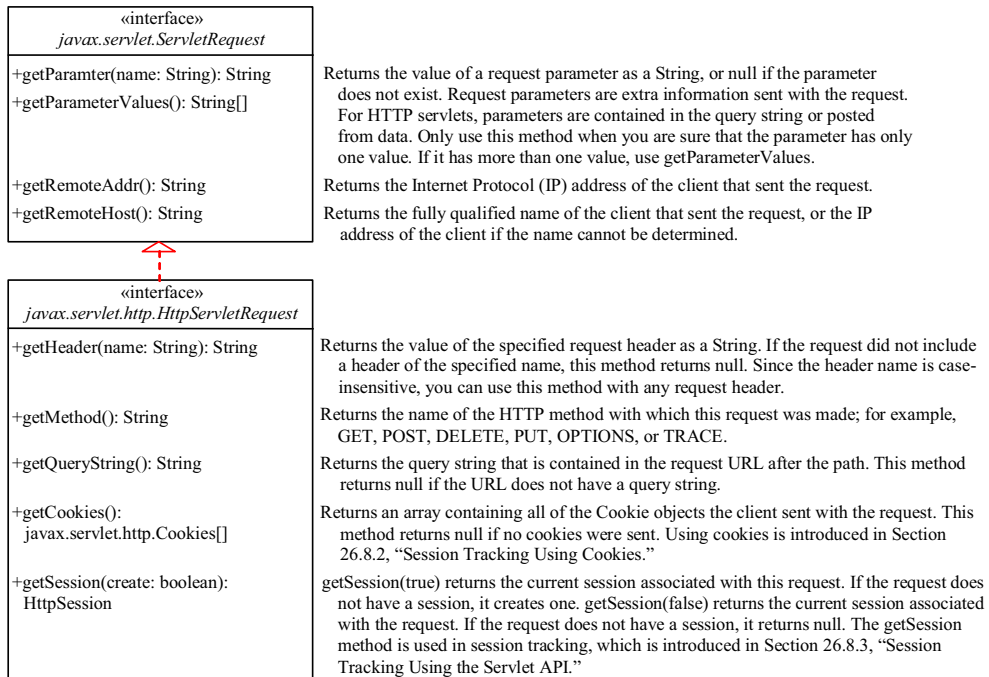


Figure 42.13

*HttpServletRequest* is a subinterface of *ServletRequest*.

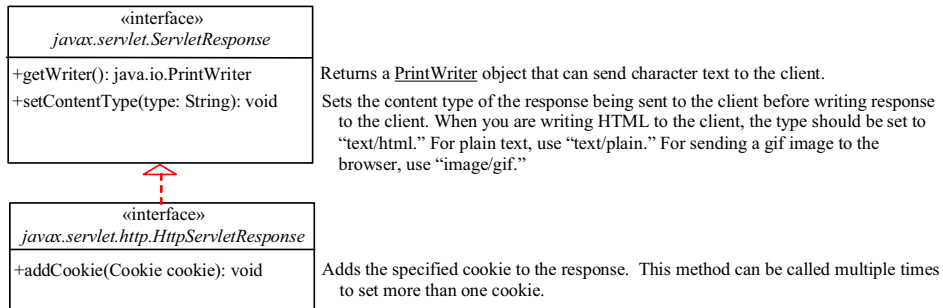
#### 42.4.4 The **ServletResponse** Interface and **HttpServletResponse** Interface

Every `doXxx` method in the *HttpServletRequest* class has a parameter of the *HttpServletResponse* type, which is an object that assists a servlet in sending a response to the client. *HttpServletResponse* is a subinterface of *ServletResponse*. *ServletResponse* defines a more general interface for sending output to the client.

The frequently used methods in these two interfaces are shown in Figure 42.14.

<PD: UML Class Diagram>





**Figure 42.14**

*HttpServletResponse* is a subinterface of *ServletResponse*.

## 42.5 Creating Servlets

Servlets are the opposite of Java applets. Java applets run from a Web browser on the client side. To write Java programs, you define classes. To write a Java applet, you define a class that extends the `Applet` class. The Web browser runs and controls the execution of the applet through the methods defined in the `Applet` class. Similarly, to write a Java servlet, you define a class that extends the `HttpServlet` class. The servlet container runs and controls the execution of the servlet through the methods defined in the `HttpServlet` class. Like a Java applet, a servlet does not have a `main` method. A servlet depends on the servlet engine to call the methods. Every servlet has a structure like the one shown below:

```

package chapter42;

import javax.servlet.*;
import javax.servlet.http.*;
import java.io.*;

public class MyServlet extends HttpServlet {
 /** Called by the servlet engine to initialize servlet */
 public void init() throws ServletException {
 ...
 }

 /** Process the HTTP Get request */
 public void doGet(HttpServletRequest request,
HttpServletResponse
response) throws ServletException, IOException {
 ...
 }

 /** Process the HTTP Post request */
 public void doPost(HttpServletRequest request,
HttpServletResponse
response) throws ServletException, IOException {
 ...
 }

 /** Called by the servlet engine to release resource */

```

```

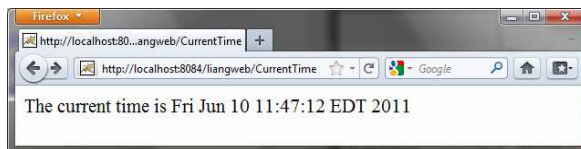
 public void destroy() {
 ...
 }

 // Other methods if necessary
}

```

The servlet engine controls the servlets using `init`, `doGet`, `doPost`, `destroy`, and other methods. By default, the `doGet` and `doPost` methods do nothing. To handle a GET request, you need to override the `doGet` method; to handle a POST request, you need to override the `doPost` method.

Listing 42.2 gives a simple Java servlet that generates a dynamic Web page for displaying the current time, as shown in Figure 42.15.



**Figure 42.15**

Servlet `CurrentTime` displays the current time.

#### Listing 42.2 `CurrentTime.java`

```

<Side Remark line 9: process GET>
<Side Remark line 11: content type>
<Side Remark line 12: output to browser>
<Side Remark line 14: close stream>
package chapter42;

import javax.servlet.*;
import javax.servlet.http.*;
import java.io.*;

public class CurrentTime extends HttpServlet {
 /** Process the HTTP Get request */
 public void doGet(HttpServletRequest request, HttpServletResponse
 response) throws ServletException, IOException {
 response.setContentType("text/html");
 PrintWriter out = response.getWriter();
 out.println("<p>The current time is " + new java.util.Date());
 out.close(); // Close stream
 }
}

```

The `HttpServlet` class has a `doGet` method. The `doGet` method is invoked when the browser issues a request to the servlet using the GET method. Your servlet class should override the `doGet` method to respond to the GET request. In this case, you write the code to display the current time.

Servlets return responses to the browser through an `HttpServletResponse` object. Since the `setContentType("text/html")` method sets the MIME type to "text/html," the browser will display the response in HTML. The `getWriter` method returns a `PrintWriter` object for sending HTML back to the client.

NOTE: The URL query string uses the GET method to issue a request to the servlet. The current time may not be current if the Web page for displaying the current time is cached. To ensure that a new current time is displayed, refresh the page in the browser. In the next example, you will write a new servlet that uses the POST method to obtain the current time.

## 42.6 HTML Forms

HTML forms enable you to submit data to the Web server in a convenient form. As shown in Figure 42.16, the form can contain text fields, text area, check boxes, combo boxes, lists, radio buttons, and buttons.

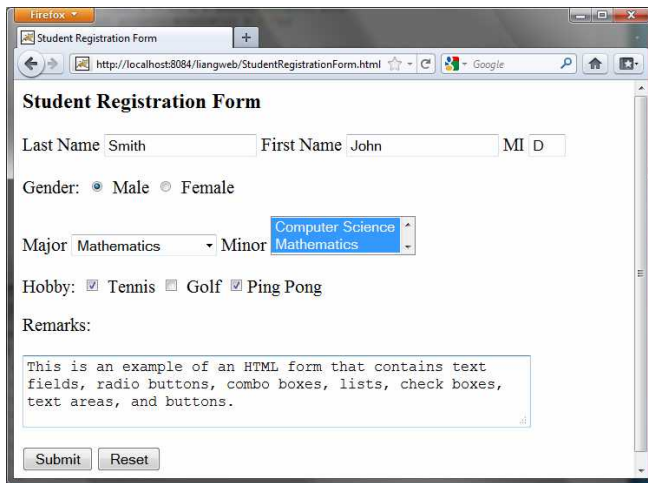


Figure 42.16

*An HTML form may contain text fields, radio buttons, combo boxes, lists, check boxes, text areas, and buttons.*

### <Side Remark: HTML/XHTML Tutorial>

The HTML code for creating the form in Figure 42.16 is given in Listing 42.3. (If you are unfamiliar with HTML, please see Supplement V.A, "HTML and XHTML Tutorial.")

### Listing 42.3 StudentRegistrationForm.html

```
<Side Remark line 9: form tag>
<Side Remark line 12: label>
<Side Remark line 13: text field>
<Side Remark line 21: radio button>
<Side Remark line 26: combo box>
<Side Remark line 35: list>
<Side Remark line 44: check box>
<Side Remark line 51: text area>
<Side Remark line 54: submit button>
<Side Remark line 55: reset button>
 <!--An HTML Form Demo -->
```

```

<html>
 <head>
 <title>Student Registration Form</title>
 </head>
 <body>
 <h3>Student Registration Form</h3>

 <form action = "GetParameters"
 method = "get">
 <!-- Name text fields -->
 <p><label>Last Name</label>
 <input type = "text" name = "lastName" size = "20" />
 <label>First Name</label>
 <input type = "text" name = "firstName" size = "20" />
 <label>MI</label>
 <input type = "text" name = "mi" size = "1" /></p>

 <!-- Gender radio buttons -->
 <p><label>Gender:</label>
 <input type = "radio" name = "gender" value = "M" checked />
 Male
 <input type = "radio" name = "gender" value = "F" /> Female</p>

 <!-- Major combo box -->
 <p><label>Major</label>
 <select name = "major" size = "1">
 <option value = "CS">Computer Science</option>
 <option value = "Math">Mathematics</option>
 <option>English</option>
 <option>Chinese</option>
 </select>

 <!-- Minor list -->
 <label>Minor</label>
 <select name = "minor" size = "2" multiple>
 <option>Computer Science</option>
 <option>Mathematics</option>
 <option>English</option>
 <option>Chinese</option>
 </select></p>

 <!-- Hobby check boxes -->
 <p><label>Hobby:</label>
 <input type = "checkbox" name = "tennis" /> Tennis
 <input type = "checkbox" name = "golf" /> Golf
 <input type = "checkbox" name = "pingPong" checked />Ping Pong
 </p>

 <!-- Remark text area -->
 <p>Remarks:</p>
 <p><textarea name = "remarks" rows = "3" cols = "56">
 </textarea></p>

 <!-- Submit and Reset buttons -->
 <p><input type = "submit" value = "Submit" />

```

```
<input type = "reset" value = "Reset" /></p>
</form>
</body>
</html>
```

The following HTML tags are used to construct HTML forms:

**<Side Remark: <form>>**

**<Side Remark: <action>**

**<Side Remark: <method>**

- **<form> ... </form>** defines a form body. The attributes for the **<form>** tag are **action** and **method**. The **action** attribute specifies the server program to be executed on the Web server when the form is submitted. The **method** attribute is either **get** or **post**.

**<Side Remark: <label>>**

- **<label> ... </label>** simply defines a label.

**<Side Remark: <input>>**

- **<input>** defines an input field. The attributes for this tag are **type**, **name**, **value**, **checked**, **size**, and **maxlength**. The **type** attribute specifies the input type. Possible types are **text** for a one-line text field, **radio** for a radio button, and **checkbox** for a check box. The **name** attribute gives a formal name for the attribute. This **name** attribute is used by the servlet program to retrieve its associated value. The names of the radio buttons in a group must be identical. The **value** attribute specifies a default value for a text field and text area. The **checked** attribute indicates whether a radio button or a check box is initially checked. The **size** attribute specifies the size of a text field, and the **maxlength** attribute specifies the maximum length of a text field.

**<Side Remark: <select>>**

- **<select> ... </select>** defines a combo box or a list. The attributes for this tag are **name**, **size**, and **multiple**. The **size** attribute specifies the number of rows visible in the list. The **multiple** attribute specifies that multiple values can be selected from a list. Set **size** to **1** and do not use a **multiple** for a combo box.

**<Side Remark: <option>>**

- **<option> ... </option>** defines a selection list within a **<select> ... </select>** tag. This tag may be used with the **value** attribute to specify a value for the selected option (e.g., **<option value = "CS">Computer Science**). If no value is specified, the selected option is the value.

**<Side Remark: <textarea>>**

- **<textarea> ... </textarea>** defines a text area. The attributes are **name**, **rows**, and **cols**. The **rows** and **cols** attributes specify the number of rows and columns in a text area.

NOTE:

**<Side Remark: create an HTML file>**

You can create the HTML file from NetBeans. Right-click liangweb and choose *New, HTML*, to display the New HTML File dialog box. Enter StudentRegistrationForm as the file name and click *Finish* to create the file.

#### 42.6.1 Obtaining Parameter Values from HTML Forms

To demonstrate how to obtain parameter values from an HTML form, Listing 42.4 creates a servlet to obtain all the parameter values from the preceding student registration form in Figure 42.16 and display their values, as shown in Figure 42.17.

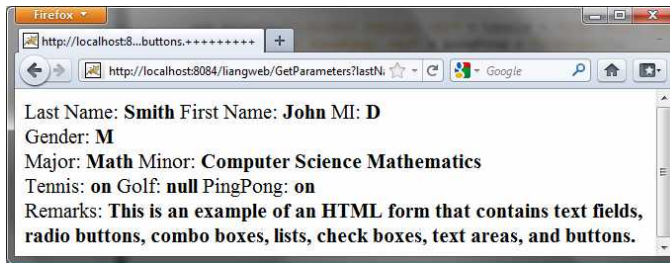


Figure 42.17

The servlet displays the parameter values entered in Figure 42.16.

#### Listing 42.4 GetParameters.java

```
<Side Remark line 9: process GET>
<Side Remark line 11: content type>
<Side Remark line 12: output to browser>
<Side Remark line 15: get parameters>
<Side Remark line 20: multiple values>
<Side Remark line 38: close stream>
package chapter42;

import javax.servlet.*;
import javax.servlet.http.*;
import java.io.*;

public class GetParameters extends HttpServlet {
 /** Process the HTTP Post request */
 public void doGet(HttpServletRequest request, HttpServletResponse
 response) throws ServletException, IOException {
 response.setContentType("text/html");
 PrintWriter out = response.getWriter();

 // Obtain parameters from the client
 String lastName = request.getParameter("lastName");
 String firstName = request.getParameter("firstName");
 String mi = request.getParameter("mi");
 String gender = request.getParameter("gender");
 String major = request.getParameter("major");
 String[] minors = request.getParameterValues("minor");
 String tennis = request.getParameter("tennis");
 String golf = request.getParameter("golf");
 String pingPong = request.getParameter("pingPong");
```

```

 String remarks = request.getParameter("remarks");
 out.println("Last Name: " + lastName + " First Name: "
 + firstName + " MI: " + mi + "
");
 out.println("Gender: " + gender + "
");
 out.println("Major: " + major + " Minor: ");

 if (minors != null)
 for (int i = 0; i < minors.length; i++)
 out.println(minors[i] + " ");

 out.println("
 Tennis: " + tennis + " Golf: " +
 golf + " PingPong: " + pingPong + "
");
 out.println("Remarks: " + remarks + "");
 out.close(); // Close stream
 }
}

```

The HTML form is already created in `StudentRegistrationForm.html` and displayed in Figure 42.16. Since the action for the form is `GetParameters`, clicking the `Submit` button invokes the `GetParameters` servlet.

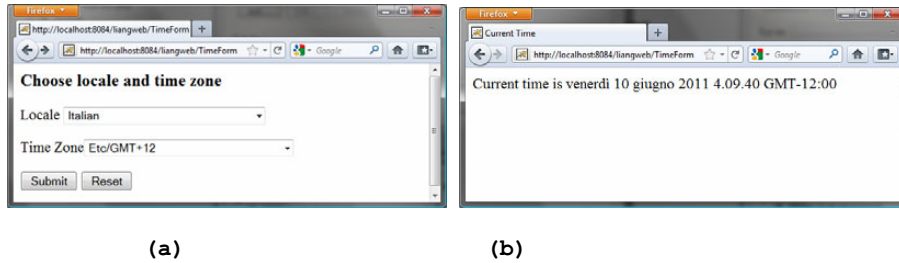
Each GUI component in the form has a name attribute. The servlet uses the name attribute in the `getParameter(attributeName)` method to obtain the parameter value as a string. In case of a list with multiple values, use the `getParameterValues(attributeName)` method to return the parameter values in an array of strings (line 20).

You may optionally specify the `value` attribute in a text field, text area, combo box, list, check box, or radio button in an HTML form. For text field and text area, the `value` attribute specifies a default value to be displayed in the text field and text area. The user can type in new values to replace it. For combo box, list, check box, and radio button, the `value` attribute specifies the parameter value to be returned from the `getParameter` and `getParameterValues` methods. If the `value` attribute is not specified for a combo box or a list, it returns the selected string from the combo box or the list. If the `value` attribute is not specified for a radio button or a check box, it returns string `on` for a checked radio button or a checked check box, and returns `null` for an unchecked check box.

NOTE: If an attribute does not exist, the `getParameter(attributeName)` method returns `null`. If an empty value of the parameter is passed to the servlet, the `getParameter(attributeName)` method returns a string with an empty value. In this case, the length of the string is `0`.

#### 42.6.2 Obtaining Current Time Based on Locale and Time Zone

This example creates a servlet that processes the GET and POST requests. The GET request generates a form that contains a combo box for locale and a combo box for time zone, as shown in Figure 42.18a. The user can choose a locale and a time zone from this form to submit a POST request to obtain the current time based on the locale and time zone, as shown in Figure 42.18b.



**Figure 42.18**

The GET method in the `TimeForm` servlet displays a form in (a), and the POST method in the `TimeForm` servlet displays the time based on locale and time zone in (b).

Listing 42.5 gives the servlet.

**Listing 42.5 TimeForm.java**

```

<Side Remark line 15: process GET>
<Side Remark line 17: content type>
<Side Remark line 18: output to browser>
<Side Remark line 20: create form>
<Side Remark line 42: close stream>
<Side Remark line 46: process POST>
<Side Remark line 48: content type>
<Side Remark line 49: output to browser>
<Side Remark line 51: get locale>
<Side Remark line 53: get time zone>
<Side Remark line 56: create calendar>
<Side Remark line 65: close stream>
package chapter42;

import javax.servlet.*;
import javax.servlet.http.*;
import java.io.*;
import java.util.*;
import java.text.*;

public class TimeForm extends HttpServlet {
 private static final String CONTENT_TYPE = "text/html";
 private Locale[] allLocale = Locale.getAvailableLocales();
 private String[] allTimeZone = TimeZone.getAvailableIDs();

 /** Process the HTTP Get request */
 public void doGet(HttpServletRequest request, HttpServletResponse
response) throws ServletException, IOException {
 response.setContentType(CONTENT_TYPE);
 PrintWriter out = response.getWriter();
 out.println("<h3>Choose locale and time zone</h3>");
 out.println("<form method=\"post\" action=\" +
\"TimeForm>");
 out.println("Locale <select size=\"1\" name=\"locale\">");

 // Fill in all locales
 for (int i = 0; i < allLocale.length; i++) {
 out.println("<option value=\"" + i + "\">" +

```



```

 allLocale[i].getDisplayNames() + "</option>");
 }
 out.println("</select>");

 // Fill in all time zones
 out.println("<p>Time Zone<select size=\"1\" name=\"timezone\">");
 for (int i = 0; i < allTimeZone.length; i++) {
 out.println("<option value=\"" + allTimeZone[i] + "\">" +
 allTimeZone[i] + "</option>");
 }
 out.println("</select>");

 out.println("<p><input type=\"submit\" value=\"Submit\" >");
 out.println("<input type=\"reset\" value=\"Reset\"></p>");
 out.println("</form>");
 out.close(); // Close stream
}

/** Process the HTTP Post request */
public void doPost(HttpServletRequest request, HttpServletResponse
 response) throws ServletException, IOException {
 response.setContentType(CONTENT_TYPE);
 PrintWriter out = response.getWriter();
 out.println("<html>");
 int localeIndex = Integer.parseInt(
 request.getParameter("locale"));
 String timeZoneID = request.getParameter("timezone");
 out.println("<head><title>Current Time</title></head>");
 out.println("<body>");
 Calendar calendar =
 new GregorianCalendar(allLocale[localeIndex]);
 TimeZone timeZone = TimeZone.getTimeZone(timeZoneID);
 DateFormat dateFormat = DateFormat.getDateInstance(
 DateFormat.FULL, DateFormat.FULL, allLocale[localeIndex]);
 dateFormat.setTimeZone(timeZone);
 out.println("Current time is " +
 dateFormat.format(calendar.getTime()) + "</p>");
 out.println("</body></html>");
 out.close(); // Close stream
}
}

```

When you run this servlet, the servlet `TimeForm`'s `doGet` method is invoked to generate the time form dynamically. The method of the form is `POST`, and the action invokes the same servlet, `TimeForm`. When the form is submitted to the server, the `doPost` method is invoked to process the request.

The variables `allLocale` and `allTimeZone` (lines 11-12), respectively, hold all the available locales and time zone IDs. The names of the locales are displayed in the locale list. The values for the locales are the indexes of the locales in the array `allLocale`. The time zone IDs are strings. They are displayed in the time zone list. They are also the values for the list. The indexes of the locale and the time zone are passed to the servlet as parameters. The `doPost` method obtains the values of the parameters (lines 51-53) and finds the current time based on the locale and time zone.

NOTE

**<Side Remark: set character encoding>**

If you choose an Asian locale (e.g., Chinese, Korean, or Japanese), the time will not be displayed properly, because the default character encoding is UTF-8. To fix this problem, insert the following statement in line 48 to set an international character encoding:

```
response.setCharacterEncoding("GB18030");
```

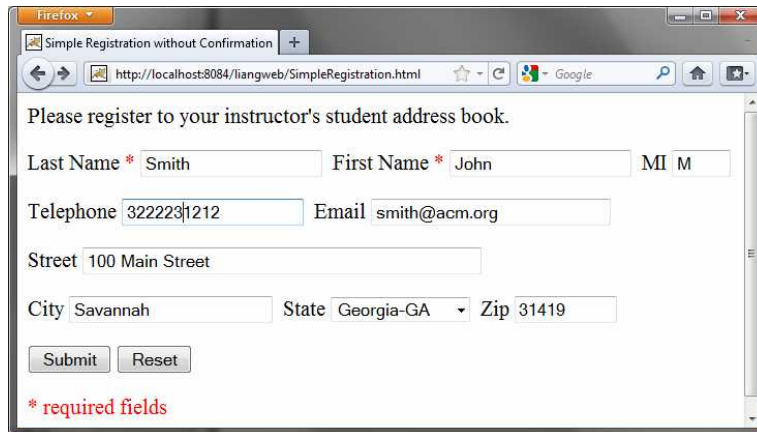
For information on encoding, see §31.6, "Character Encoding."

**\*\*\*End of NOTE**

## 42.7 Database Programming in Servlets

Many dynamic Web applications use databases to store and manage data. Servlets can connect to any relational database via JDBC. In Chapter 37, "Java Database Programming," you learned how to create Java programs to access and manipulate relational databases via JDBC. Connecting a servlet to a database is no different from connecting a Java application or applet to a database. If you know Java servlets and JDBC, you can combine them to develop interesting and practical Web-based interactive projects.

To demonstrate connecting to a database from a servlet, let us create a servlet that processes a registration form. The client enters data in an HTML form and submits the form to the server, as shown in Figure 42.19. The result of the submission is shown in Figure 42.20. The server collects the data from the form and stores them in a database.



A screenshot of a Firefox browser window displaying a registration form. The browser's address bar shows the URL `http://localhost:8084/liangweb/SimpleRegistration.html`. The form contains the following fields and values:

- Title: MI M
- Last Name: \* Smith
- First Name: \* John
- Telephone: 3222231212
- Email: smith@acm.org
- Street: 100 Main Street
- City: Savannah
- State: Georgia-GA
- Zip: 31419

At the bottom of the form are "Submit" and "Reset" buttons. A red asterisk and the text "\* required fields" are visible at the bottom left of the form area.

**Figure 42.19**

*The HTML form enables the user to enter student information.*



A screenshot of a Firefox browser window showing the result of a successful registration. The browser's address bar shows the URL `http://localhost:8084/liangweb/SimpleRegistration`. The main content area of the browser displays the message: "John Smith is now registered in the database".

**Figure 42.20**

The servlet processes the form and stores data in a database.

The registration data are stored in an `Address` table consisting of the following fields: `firstName`, `mi`, `lastName`, `street`, `city`, `state`, `zip`, `telephone`, and `email`, defined in the following statement:

```
create table Address (
 firstname varchar(25),
 mi char(1),
 lastname varchar(25),
 street varchar(40),
 city varchar(20),
 state varchar(2),
 zip varchar(5),
 telephone varchar(10),
 email varchar(30)
)
```

<Side Remark: `mysqljdbc.jar`>

<Side Remark: `ojdbc6.jar`>

MySQL, Oracle, and Access were used in Chapter 37. You can use any relational database. If the servlet uses a database driver other than the JDBC-ODBC driver (e.g., the MySQL JDBC driver and the Oracle JDBC driver), you need to add the JDBC driver (e.g., `mysqljdbc.jar` for MySQL and `ojdbc6.jar` for Oracle) into the Libraries node in the project.

<Side Remark: place `.html` file>

Create an HTML file named `SimpleRegistration.html` in Listing 42.6 for collecting the data and sending them to the database using the `post` method.

#### Listing 42.6 `SimpleRegistration.html`

<Side Remark line 9: `action`>

<Side Remark line 31: `submit form`>

```
<!-- SimpleRegistration.html -->
<html>
 <head>
 <title>Simple Registration without Confirmation</title>
 </head>
 <body>
 Please register to your instructor's student address book.

 <form method = "post" action = "SimpleRegistration">
 <p>Last Name *
 <input type = "text" name = "lastName"> </p>
 First Name *
 <input type = "text" name = "firstName"> </p>
 MI <input type = "text" name = "mi" size = "3">
 </p>
 Telephone
 <input type = "text" name = "telephone" size = "20"> </p>
 Email
 <input type = "text" name = "email" size = "28"> </p>
 Street <input type = "text" name = "street" size = "50">
 </p>
 <p>City <input type = "text" name = "city" size = "23"> </p>
```

```

State
<select size = "1" name = "state">
 <option value = "GA">Georgia-GA</option>
 <option value = "OK">Oklahoma-OK</option>
 <option value = "IN">Indiana-IN</option>
</select>
Zip <input type = "text" name = "zip" size = "9">
</p>
<p><input type = "submit" name = "Submit" value = "Submit">
<input type = "reset" value = "Reset">
</p>
</form>
<p>* required fields</p>
</body>
</html>

```

<Side Remark: place .class file>

Create the servlet named SimpleRegistration in Listing 42.7.

#### Listing 42.7 SimpleRegistration.java

<Side Remark line 14: initialize db>

<Side Remark line 18: process POST>

<Side Remark line 20: content type>

<Side Remark line 21: output to browser>

<Side Remark line 24: get parameters>

<Side Remark line 39: store record>

<Side Remark line 50: close stream>

<Side Remark line 58: connect db>

<Side Remark line 63: prepare statement>

<Side Remark line 76: set values>

<Side Remark line 85: execute SQL>

```

package chapter42;

import javax.servlet.*;
import javax.servlet.http.*;
import java.io.*;
import java.sql.*;

public class SimpleRegistration extends HttpServlet {
 // Use a prepared statement to store a student into the database
 private PreparedStatement pstmt;

 /** Initialize variables */
 public void init() throws ServletException {
 initializeJdbc();
 }

 /** Process the HTTP Post request */
 public void doPost(HttpServletRequest request, HttpServletResponse
 response) throws ServletException, IOException {
 response.setContentType("text/html");
 PrintWriter out = response.getWriter();

 // Obtain parameters from the client
 String lastName = request.getParameter("lastName");
 String firstName = request.getParameter("firstName");
 String mi = request.getParameter("mi");

```

```

String phone = request.getParameter("telephone");
String email = request.getParameter("email");
String address = request.getParameter("street");
String city = request.getParameter("city");
String state = request.getParameter("state");
String zip = request.getParameter("zip");

try {
 if (lastName.length() == 0 || firstName.length() == 0) {
 out.println("Last Name and First Name are required");
 }
 else {
 storeStudent(lastName, firstName, mi, phone, email,
 address, city, state, zip);

 out.println(firstName + " " + lastName +
 " is now registered in the database");
 }
}
catch(Exception ex) {
 out.println("Error: " + ex.getMessage());
}
finally {
 out.close(); // Close stream
}
}

/** Initialize database connection */
private void initializeJdbc() {
 try {
 // Load the JDBC driver
 Class.forName("com.mysql.jdbc.Driver");
 System.out.println("Driver loaded");

 // Establish a connection
 Connection conn = DriverManager.getConnection
 ("jdbc:mysql://localhost/javabook", "scott", "tiger");
 System.out.println("Database connected");

 // Create a Statement
 pstmt = conn.prepareStatement("insert into Address " +
 "(lastName, firstName, mi, telephone, email, street, city, "
 + "state, zip) values (?, ?, ?, ?, ?, ?, ?, ?, ?)");
 }
 catch (Exception ex) {
 ex.printStackTrace();
 }
}

/** Store a student record to the database */
private void storeStudent(String lastName, String firstName,
 String mi, String phone, String email, String address,
 String city, String state, String zip) throws SQLException {
 pstmt.setString(1, lastName);
 pstmt.setString(2, firstName);
 pstmt.setString(3, mi);
 pstmt.setString(4, phone);
 pstmt.setString(5, email);
 pstmt.setString(6, address);
 pstmt.setString(7, city);
 pstmt.setString(8, state);
}

```

```
 pstmt.setString(9, zip);
 pstmt.executeUpdate();
 }
}
```

The `init` method (line 13) is executed once when the servlet starts. After the servlet has started, the servlet can be invoked many times as long as it is alive in the servlet container. Load the driver and connect to the database from the servlet's `init` method (line 14). If a prepared statement or a callable statement is used, it should also be created in the `init` method. In this example, a prepared statement is desirable, because the servlet always uses the same insert statement with different values.

A servlet can connect to any relational database via JDBC. The `initializeJdbc` method in this example connects to a MySQL database (line 58). Once connected, it creates a prepared statement for inserting a student record into the database. MySQL is used in this example; you can replace it with any relational database.

Last name and first name are required fields. If either of them is empty, the servlet sends an error message to the client (lines 35-36). Otherwise, the servlet stores the data in the database using the prepared statement.

## 42.8 Session Tracking

Web servers use the Hyper-Text Transport Protocol (HTTP). HTTP is a stateless protocol. An HTTP Web server cannot associate requests from a client, and therefore treats each request independently. This protocol works fine for simple Web browsing, where each request typically results in an HTML file or a text file being sent back to the client. Such simple requests are isolated. However, the requests in interactive Web applications are often related. Consider the two requests in the following scenario:

Request 1: A client sends registration data to the server; the server then returns the data to the user for confirmation.

Request 2: The client confirms the data that was submitted in Request 1.

In Request 2, the data submitted in Request 1 are confirmed. These two requests are related in a session. A *session* can be defined as a series of related interactions between a single client and the Web server over a period of time. Tracking data among requests in a session is known as *session tracking*.

This section introduces three techniques for session tracking: *using hidden values*, *using cookies*, and *using the session tracking tools from servlet API*.

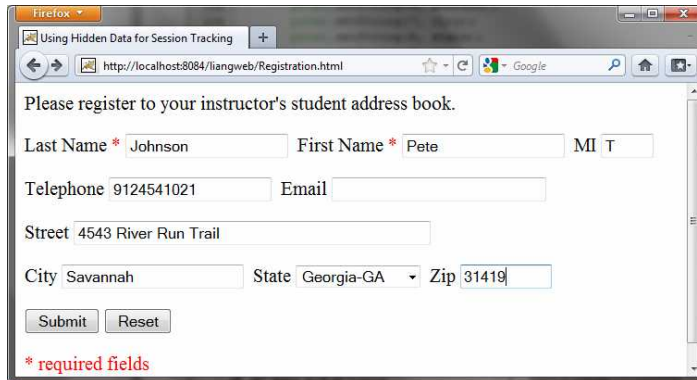
### 42.8.1 Session Tracking Using Hidden Values

You can track a session by passing data from the servlet to the client as hidden values in a dynamically generated HTML form by including a field like this one:

```
<input type = "hidden" name = "lastName" value = "Smith">
```

The next request will submit the data back to the servlet. The servlet retrieves this hidden value just like any other parameter value, using the `getParameter` method.

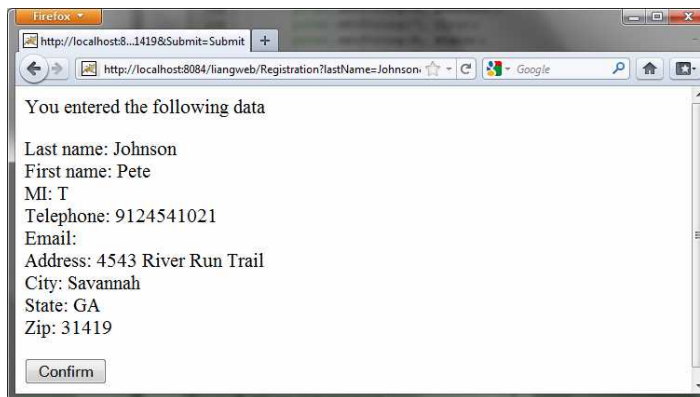
Let us use an example to demonstrate using hidden values in a form. The example creates a servlet that processes a registration form. The client submits the form using the GET method, as shown in Figure 42.21. The server collects the data in the form, displays them to the client, and asks the client for confirmation, as shown in Figure 42.22. The client confirms the data by submitting the request with the hidden values using the POST method. Finally, the servlet writes the data to a database.



A screenshot of a Firefox browser window displaying a registration form. The browser's address bar shows the URL `http://localhost:8084/liangweb/Registration.html`. The form is titled "Please register to your instructor's student address book." and contains several input fields: "Last Name \* Johnson", "First Name \* Pete", "MI T", "Telephone 9124541021", "Email", "Street 4543 River Run Trail", "City Savannah", "State Georgia-GA", and "Zip 31419". There are "Submit" and "Reset" buttons at the bottom. A red asterisk and the text "\* required fields" are visible at the bottom left of the form area.

**Figure 42.21**

*The registration form collects user information.*



A screenshot of a Firefox browser window displaying a confirmation page. The browser's address bar shows the URL `http://localhost:8084/liangweb/Registration?lastName=Johnson`. The page content reads "You entered the following data" followed by a list of the user's input: "Last name: Johnson", "First name: Pete", "MI: T", "Telephone: 9124541021", "Email:", "Address: 4543 River Run Trail", "City: Savannah", "State: GA", and "Zip: 31419". A "Confirm" button is located at the bottom of the page.

**Figure 42.22**

*The servlet asks the client for confirmation of the input.*

Create an HTML form named `Registration.html` in Listing 42.8 for collecting the data and sending it to the database using the GET method for confirmation. This file is almost identical to Listing 42.6, `SimpleRegistration.html` except that the action is replaced by `Registration` (line 9).

**Listing 42.8 Registration.html**

```

<Side Remark line 9: action>
<Side Remark line 32: submit form>
<!-- Registration.html -->
<html>
 <head>
 <title>Using Hidden Data for Session Tracking</title>
 </head>
 <body>
 Please register to your instructor's student address book.

 <form method = "get" action = "Registration">
 <p>Last Name *
 <input type = "text" name = "lastName">
 First Name *
 <input type = "text" name = "firstName">
 MI <input type = "text" name = "mi" size = "3">
 </p>
 <p>Telephone
 <input type = "text" name = "telephone" size = "20">
 Email
 <input type = "text" name = "email" size = "28">
 </p>
 <p>Street <input type = "text" name = "street" size = "50">
 </p>
 <p>City <input type = "text" name = "city" size = "23">
 State
 <select size = "1" name = "state">
 <option value = "GA">Georgia-GA</option>
 <option value = "OK">Oklahoma-OK</option>
 <option value = "IN">Indiana-IN</option>
 </select>
 Zip <input type = "text" name = "zip" size = "9">
 </p>
 <p><input type = "submit" name = "Submit" value = "Submit">
 <input type = "reset" value = "Reset">
 </p>
 </form>
 <p>* required fields</p>
 </body>
</html>

```

Create the servlet named Registration in Listing 42.9.

#### Listing 42.9 Registration.java

```

<Side Remark line 14: initialize db>
<Side Remark line 18: process GET>
<Side Remark line 20: content type>
<Side Remark line 21: output to browser>
<Side Remark line 24: get parameters>
<Side Remark line 51: client verification>
<Side Remark line 80: process POST>
<Side Remark line 82: content type>
<Side Remark line 83: output to browser>
<Side Remark line 86: get parameters>
<Side Remark line 126: store record>
 package chapter42;

```



```

import javax.servlet.*;
import javax.servlet.http.*;
import java.io.*;
import java.sql.*;

public class Registration extends HttpServlet {
 // Use a prepared statement to store a student into the database
 private PreparedStatement pstmt;

 /** Initialize variables */
 public void init() throws ServletException {
 initializeJdbc();
 }

 /** Process the HTTP Get request */
 public void doGet(HttpServletRequest request, HttpServletResponse
 response) throws ServletException, IOException {
 response.setContentType("text/html");
 PrintWriter out = response.getWriter();

 // Obtain data from the form
 String lastName = request.getParameter("lastName");
 String firstName = request.getParameter("firstName");
 String mi = request.getParameter("mi");
 String telephone = request.getParameter("telephone");
 String email = request.getParameter("email");
 String street = request.getParameter("street");
 String city = request.getParameter("city");
 String state = request.getParameter("state");
 String zip = request.getParameter("zip");

 if (lastName.length() == 0 || firstName.length() == 0) {
 out.println("Last Name and First Name are required");
 }
 else {
 // Ask for confirmation
 out.println("You entered the following data");
 out.println("<p>Last name: " + lastName);
 out.println("
First name: " + firstName);
 out.println("
MI: " + mi);
 out.println("
Telephone: " + telephone);
 out.println("
Email: " + email);
 out.println("
Address: " + street);
 out.println("
City: " + city);
 out.println("
State: " + state);
 out.println("
Zip: " + zip);

 // Set the action for processing the answers
 out.println("<p><form method=\"post\" action=\" +
 \"Registration>");
 // Set hidden values
 out.println("<p><input type=\"hidden\" " +
 "value=\" + lastName + \" name=\"lastName\">");
 out.println("<p><input type=\"hidden\" " +
 "value=\" + firstName + \" name=\"firstName\">");
 out.println("<p><input type=\"hidden\" " +
 "value=\" + mi + \" name=\"mi\">");
 out.println("<p><input type=\"hidden\" " +
 "value=\" + telephone + \" name=\"telephone\">");
 out.println("<p><input type=\"hidden\" " +

```

```

 "value=" + email + " name=\"email\>");
 out.println("<p><input type=\"hidden\" " +
 "value=" + street + " name=\"street\>");
 out.println("<p><input type=\"hidden\" " +
 "value=" + city + " name=\"city\>");
 out.println("<p><input type=\"hidden\" " +
 "value=" + state + " name=\"state\>");
 out.println("<p><input type=\"hidden\" " +
 "value=" + zip + " name=\"zip\>");
 out.println("<p><input type=\"submit\" value=\"Confirm\" >");
 out.println("</form>");
 }

 out.close(); // Close stream
}

/** Process the HTTP Post request */
public void doPost(HttpServletRequest request, HttpServletResponse
 response) throws ServletException, IOException {
 response.setContentType("text/html");
 PrintWriter out = response.getWriter();

 try {
 String lastName = request.getParameter("lastName");
 String firstName = request.getParameter("firstName");
 String mi = request.getParameter("mi");
 String telephone = request.getParameter("telephone");
 String email = request.getParameter("email");
 String street = request.getParameter("street");
 String city = request.getParameter("city");
 String state = request.getParameter("state");
 String zip = request.getParameter("zip");

 storeStudent(lastName, firstName, mi, telephone, email,
 street, city, state, zip);

 out.println(firstName + " " + lastName +
 " is now registered in the database");
 }
 catch(Exception ex) {
 out.println("Error: " + ex.getMessage());
 }
}

/** Initialize database connection */
private void initializeJdbc() {
 try {
 // Load the JDBC driver
 Class.forName("com.mysql.jdbc.Driver");
 System.out.println("Driver loaded");

 // Establish a connection
 Connection conn = DriverManager.getConnection
 ("jdbc:mysql://localhost/javabook", "scott", "tiger");
 System.out.println("Database connected");

 // Create a Statement
 pstmt = conn.prepareStatement("insert into Address " +
 "(lastName, firstName, mi, telephone, email, street, city, " +
 "state, zip) values (?, ?, ?, ?, ?, ?, ?, ?, ?)");
 }
}

```

```

 catch (Exception ex) {
 System.out.println(ex);
 }
 }

 /** Store a student record to the database */
 private void storeStudent(String lastName, String firstName,
 String mi, String phone, String email, String address,
 String city, String state, String zip) throws SQLException {
 pstmt.setString(1, lastName);
 pstmt.setString(2, firstName);
 pstmt.setString(3, mi);
 pstmt.setString(4, phone);
 pstmt.setString(5, email);
 pstmt.setString(6, address);
 pstmt.setString(7, city);
 pstmt.setString(8, state);
 pstmt.setString(9, zip);
 pstmt.executeUpdate();
 }
}

```

The servlet processes the GET request by generating an HTML page that displays the client's input and asks for the client's confirmation. The input data consist of hidden values in the newly generated forms, so they will be sent back in the confirmation request. The confirmation request uses the POST method. The servlet retrieves the hidden values and stores them in the database.

Since the first request does not write anything to the database, it is appropriate to use the GET method. Since the second request results in an update to the database, the POST method must be used.

NOTE: The hidden values could also be sent from the URL query string if the request used the GET method.

#### 42.8.2 Session Tracking Using Cookies

You can track sessions using cookies, which are small text files that store sets of name/value pairs on the disk in the client's computer. Cookies are sent from the server through the instructions in the header of the HTTP response. The instructions tell the browser to create a cookie with a given name and its associated value. If the browser already has a cookie with the key name, the value will be updated. The browser will then send the cookie with any request submitted to the same server. Cookies can have expiration dates set, after which they will not be sent to the server. The `javax.servlet.http.Cookie` is used to create and manipulate cookies, as shown in Figure 42.23.

<PD: UML Class Diagram>

javax.servlet.http.Cookie	
+Cookie(name: String, value: String)	Creates a cookie with the specified name-value pair.
+getName(): String	Returns the name of the cookie.
+getValue(): String	Returns the value of the cookie.
+setValue(newValue: String): void	Assigns a new value to a cookie after the cookie is created.
+getMaxAge(): int	Returns the maximum age of the cookie, specified in seconds.
+setMaxAge(expiration: int): void	Specifies the maximum age of the cookie. By default, this value is -1, which implies that the cookie persists until the browser exits. If you set this value to 0, the cookie is deleted.
+getSecure(): boolean	Returns true if the browser is sending cookies only over a secure protocol.
+setSecure(flag: boolean): void	Indicates to the browser whether the cookie should only be sent using a secure protocol, such as HTTPS or SSL.
+getComment(): String	Returns the comment describing the purpose of this cookie, or null if the cookie has no comment.
+setComment(purpose: String): void	Sets the comment for this cookie.

**Figure 42.23**

*Cookie stores a name/value pair and other information about the cookie.*

To send a cookie to the browser, use the `addCookie` method in the `HttpServletResponse` class, as shown below:

```
response.addCookie(cookie);
```

where `response` is an instance of `HttpServletResponse`.

To obtain cookies from a browser, use

```
request.getCookies();
```

where `request` is an instance of `HttpServletRequest`.

To demonstrate the use of cookies, let us create an example that accomplishes the same task as Listing 42.9, `Registration.java`. Instead of using hidden values for session tracking, it uses cookies.

Create the servlet named `RegistrationWithHttpCookie` in Listing 42.10. Create an HTML file named `RegistrationWithCookie.html` that is identical to `Registration.html` except that the action is replaced by `RegistrationWithCookie`.

#### Listing 42.10 `RegistrationWithCookie.java`

```
<Side Remark line 19: process GET>
<Side Remark line 25: get parameters>
<Side Remark line 40: create cookies>
<Side Remark line 42: add cookies>
<Side Remark line 62: client verification>
<Side Remark line 84: process POST>
<Side Remark line 100: get cookies>
<Side Remark line 125: store record>
package chapter42;

import javax.servlet.*;
import javax.servlet.http.*;
import java.io.*;
import java.sql.*;
```

```

public class RegistrationWithCookie extends HttpServlet {
 private static final String CONTENT_TYPE = "text/html";
 // Use a prepared statement to store a student into the database
 private PreparedStatement pstmt;

 /** Initialize variables */
 public void init() throws ServletException {
 initializeJdbc();
 }

 /** Process the HTTP Get request */
 public void doGet(HttpServletRequest request, HttpServletResponse
 response) throws ServletException, IOException {
 response.setContentType("text/html");
 PrintWriter out = response.getWriter();

 // Obtain data from the form
 String lastName = request.getParameter("lastName");
 String firstName = request.getParameter("firstName");
 String mi = request.getParameter("mi");
 String telephone = request.getParameter("telephone");
 String email = request.getParameter("email");
 String street = request.getParameter("street");
 String city = request.getParameter("city");
 String state = request.getParameter("state");
 String zip = request.getParameter("zip");

 if (lastName.length() == 0 || firstName.length() == 0) {
 out.println("Last Name and First Name are required");
 }
 else {
 // Create cookies and send cookies to browsers
 Cookie cookieLastName = new Cookie("lastName", lastName);
 // cookieLastName.setMaxAge(1000);
 response.addCookie(cookieLastName);
 Cookie cookieFirstName = new Cookie("firstName", firstName);
 response.addCookie(cookieFirstName);
 // cookieFirstName.setMaxAge(0);
 Cookie cookieMi = new Cookie("mi", mi);
 response.addCookie(cookieMi);
 Cookie cookieTelephone = new Cookie("telephone", telephone);
 response.addCookie(cookieTelephone);
 Cookie cookieEmail = new Cookie("email", email);
 response.addCookie(cookieEmail);
 Cookie cookieStreet = new Cookie("street", street);
 response.addCookie(cookieStreet);
 Cookie cookieCity = new Cookie("city", city);
 response.addCookie(cookieCity);
 Cookie cookieState = new Cookie("state", state);
 response.addCookie(cookieState);
 Cookie cookieZip = new Cookie("zip", zip);
 response.addCookie(cookieZip);

 // Ask for confirmation
 out.println("You entered the following data");
 out.println("<p>Last name: " + lastName);
 out.println("
First name: " + firstName);
 out.println("
MI: " + mi);
 out.println("
Telephone: " + telephone);
 out.println("
Email: " + email);
 }
 }
}

```

```

 out.println("
Street: " + street);
 out.println("
City: " + city);
 out.println("
State: " + state);
 out.println("
Zip: " + zip);

 // Set the action for processing the answers
 out.println("<p><form method=\"post\" action=\" +
 "RegistrationWithCookie>");
 out.println("<p><input type=\"submit\" value=\"Confirm\" >");
 out.println("</form>");
 }

 out.close(); // Close stream
}

/** Process the HTTP Post request */
public void doPost(HttpServletRequest request, HttpServletResponse
 response) throws ServletException, IOException {
 response.setContentType(CONTENT_TYPE);
 PrintWriter out = response.getWriter();

 String lastName = "";
 String firstName = "";
 String mi = "";
 String telephone = "";
 String email = "";
 String street = "";
 String city = "";
 String state = "";
 String zip = "";

 // Read the cookies
 Cookie[] cookies = request.getCookies();

 // Get cookie values
 for (int i = 0; i < cookies.length; i++) {
 if (cookies[i].getName().equals("lastName"))
 lastName = cookies[i].getValue();
 else if (cookies[i].getName().equals("firstName"))
 firstName = cookies[i].getValue();
 else if (cookies[i].getName().equals("mi"))
 mi = cookies[i].getValue();
 else if (cookies[i].getName().equals("telephone"))
 telephone = cookies[i].getValue();
 else if (cookies[i].getName().equals("email"))
 email = cookies[i].getValue();
 else if (cookies[i].getName().equals("street"))
 street = cookies[i].getValue();
 else if (cookies[i].getName().equals("city"))
 city = cookies[i].getValue();
 else if (cookies[i].getName().equals("state"))
 state = cookies[i].getValue();
 else if (cookies[i].getName().equals("zip"))
 zip = cookies[i].getValue();
 }

 try {
 storeStudent(lastName, firstName, mi, telephone, email, street,
 city, state, zip);

 out.println(firstName + " " + lastName +

```

```

 " is now registered in the database");
 }
 out.close(); // Close stream
}
catch(Exception ex) {
 out.println("Error: " + ex.getMessage());
}
}

/** Initialize database connection */
private void initializeJdbc() {
 try {
 // Load the JDBC driver
 Class.forName("com.mysql.jdbc.Driver");
 System.out.println("Driver loaded");

 // Establish a connection
 Connection conn = DriverManager.getConnection
 ("jdbc:mysql://localhost/javabook", "scott", "tiger");
 System.out.println("Database connected");

 // Create a Statement
 pstmt = conn.prepareStatement("insert into Address " +
 "(lastName, firstName, mi, telephone, email, street, city, "
 + "state, zip) values (?, ?, ?, ?, ?, ?, ?, ?, ?)");
 }
 catch (Exception ex) {
 System.out.println(ex);
 }
}

/** Store a student record to the database */
private void storeStudent(String lastName, String firstName,
 String mi, String telephone, String email, String street,
 String city, String state, String zip) throws SQLException {
 pstmt.setString(1, lastName);
 pstmt.setString(2, firstName);
 pstmt.setString(3, mi);
 pstmt.setString(4, telephone);
 pstmt.setString(5, email);
 pstmt.setString(6, street);
 pstmt.setString(7, city);
 pstmt.setString(8, state);
 pstmt.setString(9, zip);
 pstmt.executeUpdate();
}
}

```

You have to create a cookie for each value you want to track, using the `Cookie` class's only constructor, which defines a cookie's name and value as shown below (line 40):

```
Cookie cookieLastName = new Cookie("lastName", lastName);
```

To send the cookie to the browser, use a statement like this one (line 42):

```
response.addCookie(cookieLastName);
```

If a cookie with the same name already exists in the browser, its value is updated; otherwise, a new cookie is created.

Cookies are automatically sent to the Web server with each request from the client. The servlet retrieves all the cookies into an array using the getCookies method (line 100):

```
Cookie[] cookies = request.getCookies();
```

To obtain the name of the cookie, use the getName method (line 104):

```
String name = cookies[i].getName();
```

The cookie's value can be obtained using the getValue method:

```
String value = cookies[i].getValue();
```

Cookies are stored as strings just like form parameters and hidden values. If a cookie represents a numeric value, you have to convert it into an integer or a double, using the parseInt method in the Integer class or the parseDouble method in the Double class.

By default, a newly created cookie persists until the browser exits. However, you can set an expiration date, using the setMaxAge method, to allow a cookie to stay in the browser for up to 2,147,483,647 seconds (approximately 24,855 days).

#### 42.8.3 Session Tracking Using the Servlet API

You have now learned both session tracking using hidden values and session tracking using cookies. These two session-tracking methods have problems. They send data to the browser either as hidden values or as cookies. The data are not secure, and anybody with knowledge of computers can obtain them. The hidden data are in HTML form, which can be viewed from the browser. Cookies are stored in the Cache directory of the browser. Because of security concerns, some browsers do not accept cookies. The client can turn the cookies off and limit their number. Another problem is that hidden data and cookies pass data as strings. You cannot pass objects using these two methods.

To address these problems, Java servlet API provides the javax.servlet.http.HttpSession interface, which provides a way to identify a user across more than one page request or visit to a Web site and to store information about that user. The servlet container uses this interface to create a session between an HTTP client and an HTTP server. The session persists for a specified time period, across more than one connection or page request from the user. A session usually corresponds to one user, who may visit a site many times. The session enables tracking of a large set of data. The data can be stored as objects and are secure because they are kept on the server side.

To use the Java servlet API for session tracking, first create a session object using the getSession() method in the HttpServletRequest interface:

```
HttpSession session = request.getSession();
```

This obtains the session or creates a new session if the client does not have a session on the server.

The HttpSession interface provides the methods for reading and storing data to the session, and for manipulating the session, as shown in Figure 42.24.



<PD: UML Class Diagram>

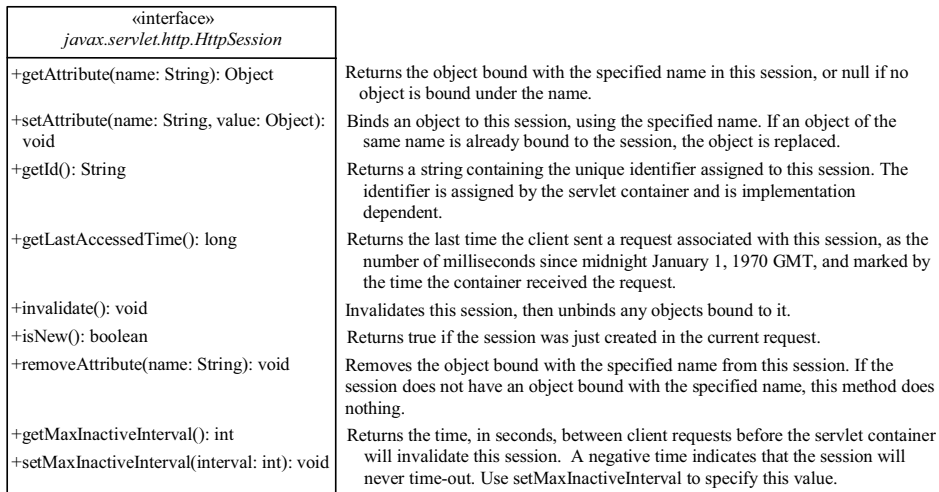


Figure 42.24

*HttpSession* establishes a persistent session between a client with multiple requests and the server.

NOTE: HTTP is stateless. So how does the server associate a session with multiple requests from the same client? This is handled behind the scenes by the servlet container and is transparent to the servlet programmer.

To demonstrate using HttpSession, let us rewrite Listing 42.9, Registration.java, and Listing 42.10, RegistrationWithCookie.java. Instead of using hidden values or cookies for session tracking, it uses servlet HttpSession.

Create the servlet named RegistrationWithHttpSession in Listing 42.11. Create an HTML file named RegistrationWithHttpSession.html that is identical to Registration.html except that the action is replaced by RegistrationWithHttpSession.

**Listing 42.11 RegistrationWithHttpSession.java**

<Side Remark line 18: process GET>  
<Side Remark line 25: get parameters>  
<Side Remark line 40: create address>  
<Side Remark line 52: create session>  
<Side Remark line 55: set attribute>  
<Side Remark line 80: process POST>  
<Side Remark line 87: get session>  
<Side Remark line 90: get address>  
<Side Remark line 93: store address>

```
package chapter42;

import javax.servlet.*;
import javax.servlet.http.*;
import java.io.*;
import java.sql.*;
```

```

public class RegistrationWithHttpSession extends HttpServlet {
 // Use a prepared statement to store a student into the database
 private PreparedStatement pstmt;

 /** Initialize variables */
 public void init() throws ServletException {
 initializeJdbc();
 }

 /** Process the HTTP Get request */
 public void doGet(HttpServletRequest request, HttpServletResponse
 response) throws ServletException, IOException {
 // Set response type and output stream to the browser
 response.setContentType("text/html");
 PrintWriter out = response.getWriter();

 // Obtain data from the form
 String lastName = request.getParameter("lastName");
 String firstName = request.getParameter("firstName");
 String mi = request.getParameter("mi");
 String telephone = request.getParameter("telephone");
 String email = request.getParameter("email");
 String street = request.getParameter("street");
 String city = request.getParameter("city");
 String state = request.getParameter("state");
 String zip = request.getParameter("zip");

 if (lastName.length() == 0 || firstName.length() == 0) {
 out.println("Last Name and First Name are required");
 }
 else {
 // Create an Address object
 Address address = new Address();
 address.setLastName(lastName);
 address.setFirstName(firstName);
 address.setMi(mi);
 address.setTelephone(telephone);
 address.setEmail(email);
 address.setStreet(street);
 address.setCity(city);
 address.setState(state);
 address.setZip(zip);

 // Get an HttpSession or create one if it does not exist
 HttpSession httpSession = request.getSession();

 // Store student object to the session
 httpSession.setAttribute("address", address);

 // Ask for confirmation
 out.println("You entered the following data");
 out.println("<p>Last name: " + lastName);
 out.println("<p>First name: " + firstName);
 out.println("<p>MI: " + mi);
 out.println("<p>Telephone: " + telephone);
 out.println("<p>Email: " + email);
 out.println("<p>Address: " + street);
 out.println("<p>City: " + city);
 out.println("<p>State: " + state);
 out.println("<p>Zip: " + zip);

```

```

 // Set the action for processing the answers
 out.println("<p><form method=\"post\" action=\" +
 "RegistrationWithHttpSession>");
 out.println("<p><input type=\"submit\" value=\"Confirm\" >");
 out.println("</form>");
 }

 out.close(); // Close stream
}

/** Process the HTTP Post request */
public void doPost(HttpServletRequest request, HttpServletResponse
 response) throws ServletException, IOException {
 // Set response type and output stream to the browser
 response.setContentType("text/html");
 PrintWriter out = response.getWriter();

 // Obtain the HttpSession
 HttpSession httpSession = request.getSession();

 // Get the Address object in the HttpSession
 Address address = (Address) (httpSession.getAttribute("address"));

 try {
 storeStudent(address);

 out.println(address.getFirstName() + " " + address.getLastName()
 + " is now registered in the database");
 out.close(); // Close stream
 }
 catch(Exception ex) {
 out.println("Error: " + ex.getMessage());
 }
}

/** Initialize database connection */
private void initializeJdbc() {
 try {
 // Load the JDBC driver
 Class.forName("com.mysql.jdbc.Driver");
 System.out.println("Driver loaded");

 // Establish a connection
 Connection conn = DriverManager.getConnection
 ("jdbc:mysql://localhost/javabook", "scott", "tiger");
 System.out.println("Database connected");

 // Create a Statement
 pstmt = conn.prepareStatement("insert into Address " +
 "(lastName, firstName, mi, telephone, email, street, city, "
 + "state, zip) values (?, ?, ?, ?, ?, ?, ?, ?, ?)");
 }
 catch (Exception ex) {
 System.out.println(ex);
 }
}

/** Store an address to the database */
private void storeStudent(Address address) throws SQLException {
 pstmt.setString(1, address.getLastName());
}

```

```

 pstmt.setString(2, address.getFirstName());
 pstmt.setString(3, address.getMi());
 pstmt.setString(4, address.getTelephone());
 pstmt.setString(5, address.getEmail());
 pstmt.setString(6, address.getStreet());
 pstmt.setString(7, address.getCity());
 pstmt.setString(8, address.getState());
 pstmt.setString(9, address.getZip());
 pstmt.executeUpdate();
 }
}

```

The statement (line 52)

```

 HttpSession httpSession = request.getSession();

```

obtains a session, or creates a new session if the session does not exist.

Since objects can be stored in `HttpSession`, this program defines an `Address` class. An `Address` object is created and is stored in the session using the `setAttribute` method, which binds the object with a name like the one shown below (line 55):

```

 httpSession.setAttribute("address", address);

```

To retrieve the object, use the following statement (line 90):

```

 Address address = (Address) (httpSession.getAttribute("address"));

```

There is only one session between a client and a servlet. You can store any number of objects in a session. By default, the maximum inactive interval on many Web servers including Tomcat and GlassFish is 1800 seconds (i.e., a half-hour), meaning that the session expires if there is no activity for 30 minutes. You can change the default using the `setMaxInactiveInterval` method. For example, to set the maximum inactive interval to one hour, use

```

 httpSession.setMaxInactiveInterval(3600);

```

If you set a negative value, the session will never expire.

**<Side Remark: create Address class>**

For this servlet program to work, you have to create the `Address` class in NetBeans, as follows:

1. Choose *New, Java Class* from the context menu of the `liangweb` node in the project pane to display the New Java Class dialog box.
2. Enter `Address` as the Class Name and `chapter42` as the package name. Click *Finish* to create the class.
3. Enter the code, as shown in Listing 42.12.

**Listing 42.12 Address.java**

**<Side Remark line 1: package chapter42>**

**<Side Remark line 3: class Address>**

```

package chapter42;

public class Address {
 private String firstName;
 private String mi;
 private String lastName;
 private String telephone;
}

```

```
private String street;
private String city;
private String state;
private String email;
private String zip;

public String getFirstName() {
 return this.firstName;
}

public void setFirstName(String firstName) {
 this.firstName = firstName;
}

public String getMi() {
 return this.mi;
}

public void setMi(String mi) {
 this.mi = mi;
}

public String getLastName() {
 return this.lastName;
}

public void setLastName(String lastName) {
 this.lastName = lastName;
}

public String getTelephone() {
 return this.telephone;
}

public void setTelephone(String telephone) {
 this.telephone = telephone;
}

public String getEmail() {
 return this.email;
}

public void setEmail(String email) {
 this.email = email;
}

public String getStreet() {
 return this.street;
}

public void setStreet(String street) {
 this.street = street;
}

public String getCity() {
```

```

 return this.city;
}

 public void setCity(String city) {
 this.city = city;
}

 public String getState() {
 return this.state;
}

 public void setState(String state) {
 this.state = state;
}

 public String getZip() {
 return this.zip;
}

 public void setZip(String zip) {
 this.zip = zip;
}
}

```

This support class will also be reused in the upcoming chapters.

## 42.9 Sending Images from Servlets

So far you have learned how to write Java servlets that generate dynamic HTML text. Java servlets are not limited to sending text to a browser. They can return images on demand. The images can be stored in files or created from programs.

### 42.9.1 Sending Image from Files

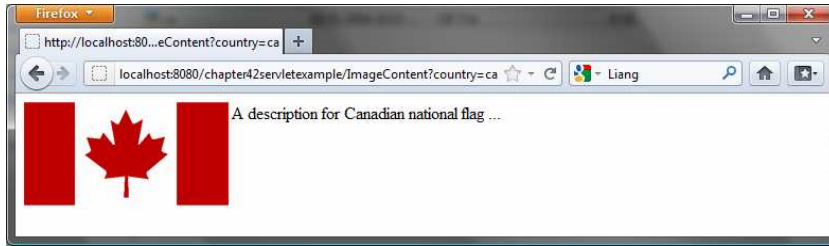
You can use the HTML `<img>` tag to send images from files. The syntax for the tag is:

```

```

The attribute `src` specifies the source of the image. The attribute `alt` specifies an alternative text to be displayed in case the image cannot be displayed on the browser. The attribute `align` tells the browser where to place the image.

To demonstrate getting images from a file in a servlet, let us create a servlet that dynamically generates the flag of a country and a text that describes the flag, as shown in Figure 42.25. The flag is stored in an image file, and the text that describes the flag is stored in a text file.



**Figure 42.25**

*The servlet returns an image along with the text.*

Create the servlet named `ImageContent` in Listing 42.13.

**Listing 42.13 `ImageContent.java`**

<Side Remark line 16: image tag>

<Side Remark line 20: read file>

```
package chapter42;

import javax.servlet.*;
import javax.servlet.http.*;
import java.io.*;

public class ImageContent extends HttpServlet {
 /** Process the HTTP Get request */
 public void doGet(HttpServletRequest request, HttpServletResponse
 response) throws ServletException, IOException {
 response.setContentType("text/html");
 PrintWriter out = response.getWriter();

 String country = request.getParameter("country");

 out.println("<img src = \"resources/image/\" + country + \".gif\"
 + \"\" align=left>");

 // Read description from a file and send it to the browser
 java.util.Scanner input = new java.util.Scanner(
 new File("c:\\book\\" + country + ".txt"));

 // Read a line from the text file and send it to the browser
 while (input.hasNext()) {
 out.println(input.nextLine());
 }

 out.close();
 }
}
```

<Side Remark: image file location>

You should create a directory `C:\book\liangweb\web\resources\image` and store image files in this directory.

The `country` parameter determines which image file and text file are displayed. The servlet sends the HTML contents to the browser. The contents contain an `<img>` tag (lines 16-17) that references to the image file.

The servlet reads the characters from the text file and sends them to the browser (lines 20-26).

#### 42.9.2 Sending Images from the *Image* Object

The preceding example displays an image stored in an image file. You can also display an image dynamically created in the program.

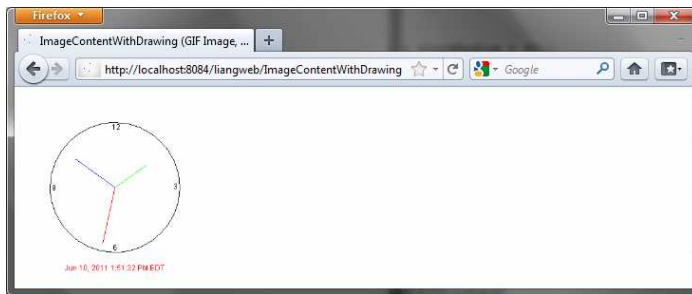
Before the image is sent to a browser, it must be encoded into a format acceptable to the browser. Image encoders are not part of Java API, but several free encoders are available. One of them is the `GifEncoder` class (<http://www.acme.com/java/software/Acme.JPM.Encoders.GifEncoder.html>), which is included in `\book\lib\acme.jar`. Use the following statement to encode and send the image to the browser:

```
new GifEncoder(image, out, true).encode();
```

where `out` is a binary output stream from the servlet to the browser, which can be obtained using the following statement:

```
OutputStream out = response.getOutputStream();
```

To demonstrate dynamically generating images from a servlet, let us create a servlet that displays a clock to show the current time, as shown in Figure 42.26.



**Figure 42.26**

*The servlet returns a clock that displays the current time.*

#### <Side Remark: `acme.jar`>

Create the servlet named `ImageContentWithDrawing` in Listing 42.14. Add `acme.jar` in the Libraries node in the `liangweb` project in NetBeans. (`acme.jar` is in `c:\book\lib`.)

#### **Listing 42.14 `ImageContentWithDrawing.java`**

```
<Side Remark line 10: import GifEncoder>
<Side Remark line 18: process GET>
<Side Remark line 20: gif type>
<Side Remark line 24: image>
<Side Remark line 28: graphics>
<Side Remark line 30: draw graphics>
<Side Remark line 35: close stream>
<Side Remark line 38: draw clock>
```



```

package chapter42;

import javax.servlet.*;
import javax.servlet.http.*;
import java.io.*;
import java.util.*;
import java.text.*;
import java.awt.*;
import java.awt.image.BufferedImage;
import Acme.JPM.Encoders.GifEncoder;

public class ImageContentWithDrawing extends HttpServlet {
 /** Initialize variables */
 private final static int width = 300;
 private final static int height = 300;

 /** Process the HTTP Get request */
 public void doGet(HttpServletRequest request, HttpServletResponse
 response) throws ServletException, IOException {
 response.setContentType("image/gif");
 OutputStream out = response.getOutputStream();

 // Create image
 Image image = new BufferedImage(width, height,
 BufferedImage.TYPE_INT_ARGB);

 // Get Graphics context of the image
 Graphics g = image.getGraphics();

 drawClock(g); // Draw a clock on graphics

 // Encode the image and send to the output stream
 new GifEncoder(image, out, true).encode();

 out.close(); // Close stream
 }

 private void drawClock(Graphics g) {
 // Initialize clock parameters
 int clockRadius =
 (int)(Math.min(width, height) * 0.7 * 0.5);
 int xCenter = (width) / 2;
 int yCenter = (height) / 2;

 // Draw circle
 g.setColor(Color.black);
 g.drawOval(xCenter - clockRadius, yCenter - clockRadius,
 2 * clockRadius, 2 * clockRadius);
 g.drawString("12", xCenter - 5, yCenter - clockRadius + 12);
 g.drawString("9", xCenter - clockRadius + 3, yCenter + 5);
 g.drawString("3", xCenter + clockRadius - 10, yCenter + 3);
 g.drawString("6", xCenter - 3, yCenter + clockRadius - 3);

 // Get current time using GregorianCalendar
 TimeZone timeZone = TimeZone.getDefault();
 GregorianCalendar cal = new GregorianCalendar(timeZone);

 // Draw second hand
 int second = (int)cal.get(GregorianCalendar.SECOND);
 int sLength = (int)(clockRadius * 0.9);
 int xSecond = (int)(xCenter + sLength * Math.sin(second *

```

```

 (2 * Math.PI / 60));
 int ySecond = (int)(yCenter - sLength * Math.cos(second *
 (2 * Math.PI / 60)));
 g.setColor(Color.red);
 g.drawLine(xCenter, yCenter, xSecond, ySecond);

 // Draw minute hand
 int minute = (int)cal.get(GregorianCalendar.MINUTE);
 int mLength = (int)(clockRadius * 0.75);
 int xMinute = (int)(xCenter + mLength * Math.sin(minute *
 (2 * Math.PI / 60)));
 int yMinute = (int)(yCenter - mLength * Math.cos(minute *
 (2 * Math.PI / 60)));
 g.setColor(Color.blue);
 g.drawLine(xCenter, yCenter, xMinute, yMinute);

 // Draw hour hand
 int hour = (int)cal.get(GregorianCalendar.HOUR_OF_DAY);
 int hLength = (int)(clockRadius * 0.6);
 int xHour = (int)(xCenter + hLength * Math.sin((hour + minute
 / 60.0) * (2 * Math.PI / 12)));
 int yHour = (int)(yCenter - hLength * Math.cos((hour + minute
 / 60.0) * (2 * Math.PI / 12)));
 g.setColor(Color.green);
 g.drawLine(xCenter, yCenter, xHour, yHour);

 // Set display format in specified style, locale and time zone
 DateFormat formatter = DateFormat.getDateInstance
 (DateFormat.MEDIUM, DateFormat.LONG);

 // Display current date
 g.setColor(Color.red);
 String today = formatter.format(cal.getTime());
 FontMetrics fm = g.getFontMetrics();
 g.drawString(today, (width -
 fm.stringWidth(today)) / 2, yCenter + clockRadius + 30);
 }
}

```

Since the image is sent to the browser as binary data, the content type of the response is set to image/gif (line 20). The `GifEncoder` class is used to encode the image into content understood by the browser (line 33). The content is sent to the `OutputStream` object `out`.

The program creates an image with the specified width, height, and image type, using the `BufferedImage` class (lines 24-25):

```

Image image = new BufferedImage(width, height,
 BufferedImage.TYPE_INT_ARGB);

```

To draw things on the image, you need to get its graphics context using the `getGraphics` method (line 28):

```

Graphics g = image.getGraphics();

```

You can use various drawing methods in the `Graphics` class to draw simple shapes, or you can use Java 2D to draw more sophisticated graphics. This example uses simple drawing methods to draw a clock that displays the current time.

### 42.9.3 Sending Images and Text Together

The servlet in the preceding example returns images. Often images are mixed with other contents. In this case, you have to set the content type to "image/gif" before sending images, and set the content type to "text/html" before sending the text. However, the content type cannot be changed in one request. To circumvent this restriction, you may embed a GET request for displaying the image in a `<img>` tag in the HTML content. When the HTML content is displayed, a separate GET request for retrieving the image is then sent to the server. Thus text and image are obtained through two separate GET requests.

To demonstrate mixing images and texts, let us create a servlet in Listing 42.15 that mixes the clock image created in the preceding example with some text, as shown in Figure 42.27.

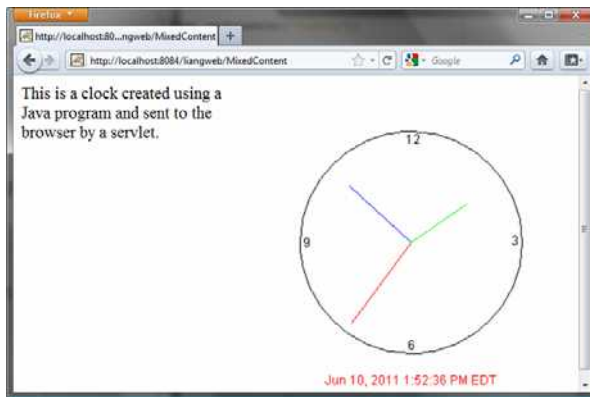


Figure 42.27

*The servlet returns an image along with the text.*

#### Listing 42.15 MixedContent.java

<Side Remark line 9: process GET>  
<Side Remark line 11: content type>  
<Side Remark line 14: get parameter>  
<Side Remark line 16: image tag>  
<Side Remark line 22: close stream>

```
package chapter42;

import javax.servlet.*;
import javax.servlet.http.*;
import java.io.*;

public class MixedContent extends HttpServlet {
 /** Process the HTTP Get request */
 public void doGet(HttpServletRequest request, HttpServletResponse
 response) throws ServletException, IOException {
 response.setContentType("text/html");
 PrintWriter out = response.getWriter();

 String country = request.getParameter("country");

 out.println("<img src = \"\" +
```

```

 "ImageContentWithDrawing\" align=right>");
 out.println("This is a clock created using a Java program " +
 "and sent to the browser by a servlet.");

 out.close();
}
}

```

The servlet generates an HTML file with the image tag

```

```

The HTML file is rendered by the browser. When the browser sees the image tag, it sends the request to the server. `ImageContentWithDrawing`, created in Listing 42.14, is invoked to send the image to the browser.

### Key Terms

- Common Gateway Interface
- CGI programs
- cookie
- GET and POST methods
- GlassFish
- HTML form
- URL query string
- servlet
- servlet container (servlet engine)
- servlet life-cycle methods
- Tomcat

### Chapter Summary

1. A servlet is a special kind of program that runs from a Web server. Tomcat and GlassFish are Web servers that can run servlets.
2. A servlet URL is specified by the host name, port, and request string (e.g., `http://localhost:8084/liangweb/ServletClass`). There are several ways to invoke a servlet: (1) by typing a servlet URL from a Web browser, (2) by placing a hyper link in an HTML page, and (3) by embedding a servlet URL in an HTML form. All the requests trigger the GET method, except that in the HTML form you can explicitly specify the POST method.
3. You develop a servlet by defining a class that extends the `HttpServlet` class, implements the `doGet(HttpServletRequest, HttpServletResponse)` method to respond to the GET method, and implements the `doPost(HttpServletRequest, HttpServletResponse)` method to respond to the POST method.
4. The request information passed from a client to the servlet is contained in an object of `HttpServletRequest`. You can use the methods `getParameter`, `getParameterValues`, `getRemoteAddr`, `getRemoteHost`, `getHeader`, `getQueryString`, `getCookies`, and `getSession` to obtain the information from the request.
5. The content sent back to the client is contained in an object of `HttpServletResponse`. To send content to the client, first set the type of the content (e.g., `html/plain`) using the `setContentType(contentType)` method, then output the content

- through an I/O stream on the `HttpServletResponse` object. You can obtain a character `PrintWriter` stream using the `getWriter()` method and obtain a binary `OutputStream` using the `getOutputStream()` method.
6. A servlet may be shared by many clients. When the servlet is first created, its `init` method is called. It is not called again as long as the servlet is not destroyed. The `service` method is invoked each time the server receives a request for the servlet. The server spawns a new thread and invokes `service`. The `destroy` method is invoked after a timeout period has passed or the Web server is stopped.
  7. There are three ways to track a session. You can track a session by passing data from the servlet to the client as a hidden value in a dynamically generated HTML form by including a field such as `<input type="hidden" name="lastName" value="Smith">`. The next request will submit the data back to the servlet. The servlet retrieves this hidden value just like any other parameter value using the `getParameter` method.
  8. You can track sessions using cookies. A cookie is created using the constructor `new Cookie(String name, String value)`. Cookies are sent from the server through the object of `HttpServletResponse` using the `addCookie(aCookie)` method to tell the browser to add a cookie with a given name and its associated value. If the browser already has a cookie with the key name, the value will be updated. The browser will then send the cookie with any request submitted to the same server. Cookies can have expiration dates set, after which they will not be sent to the server.
  9. Java servlet API provides a session-tracking tool that enables tracking of a large set of data. A session can be obtained using the `getSession()` method through an `HttpServletRequest` object. The data can be stored as objects and are secure because they are kept on the server side using the `setAttribute(String name, Object value)` method.
  10. Java servlets are not limited to sending text to a browser. They can return images in GIF, JPEG, or PNG format.

### Test Questions

Do the test questions for this chapter online at  
[www.cs.armstrong.edu/liang/intro9e/test.html](http://www.cs.armstrong.edu/liang/intro9e/test.html).

### Review Questions

*Sections 42.1-42.2*

42.1 What is the common gateway interface?

42.2 What are the differences between the GET and POST methods in an HTML form?

42.3 Can you submit a GET request directly from a URL? Can you submit a POST request directly from a URL?

42.4 What is wrong in the following URL for submitting a GET request to the servlet `FindScore` on host `liang` at port `8084` with parameter `name`?

`http://liang:8084/findScore?name="P Yates"`

42.5 What are the differences between CGI and servlets?

Section 42.3

42.6 Can you display an HTML file (e.g. c:\test.html) by typing the complete file name in the Address field of Internet Explorer? Can you run a servlet by simply typing the servlet class file name?

42.7 How do you create a Web project in NetBeans?

42.8 How do you create a servlet in NetBeans?

42.9 How do you run a servlet in NetBeans?

42.10 When you run a servlet from NetBeans, what is the port number by default? What happens if the port number is already in use?

42.11 What is the .war file? How do you obtain a .war file for a Web project in NetBeans?

Section 42.4

42.12 Describe the life cycle of a servlet.

42.13 Suppose that you started the Web server, ran the following servlet twice by issuing an appropriate URL from the Web browser, and finally stopped Tomcat. What was displayed on the console when the servlet was first invoked? What was displayed on the console when the servlet was invoked for the second time? What was displayed on the console when Tomcat was shut down?

```
import javax.servlet.*;
import javax.servlet.http.*;
import java.io.*;

public class Test extends HttpServlet {
 public Test() {
 System.out.println("Constructor called");
 }

 /** Initialize variables */
 public void init() throws ServletException {
 System.out.println("init called");
 }

 /** Process the HTTP Get request */
 public void doGet(HttpServletRequest request,
 HttpServletResponse response)
 throws ServletException, IOException {
 System.out.println("doGet called");
 }

 /** Clean up resources */
 public void destroy() {
 System.out.println("destroy called");
 }
}
```

Sections 42.5-42.7

42.14 What would be displayed if you changed the content type to "html/plain" in Listing 42.2, CurrentTime.java?

42.15 The statement `out.close()` is used to close the output stream to response. Why isn't this statement enclosed in a try-catch block?

42.16 What happens when you invoke `request.getParameter(paramName)` if `paramName` does not exist?

42.17 How do you write a text field, combo box, check box, and text area in an HTML form?

42.18 How do you retrieve the parameter value for a text field, combo box, list, check box, radio button, and text area from an HTML form?

42.19 If the servlet uses a database driver other than the JDBC-ODBC driver, where should the driver be placed in NetBeans?

#### Section 42.8

42.20 What is session tracking? What are three techniques for session tracking?

42.21 How do you create a cookie, send a cookie to a browser, get cookies from a browser, get the name of a cookie, set a new value in the cookie, and set cookie expiration time?

42.22 Do you have to create five `Cookie` objects in the servlet in order to send five cookies to the browser?

42.23 How do you get a session, set object value for the session, and get object value from the session?

42.24 Suppose you inserted the following code in line 53 in Listing 42.11.

```
httpSession.setMaxInactiveInterval(1);
```

What would happen after the user clicked the *Confirm* button from the browser? Test your answer by running the program.

42.25 Suppose you inserted the following code in line 53 in Listing 42.11.

```
httpSession.setMaxInactiveInterval(-1);
```

What would happen after the user clicked the *Confirm* button from the browser?

#### Section 42.9

42.26 What output stream should you use to send images to the browser? What content type do you have to set for the response?

42.27 How do you deal with dynamic contents with images and text?

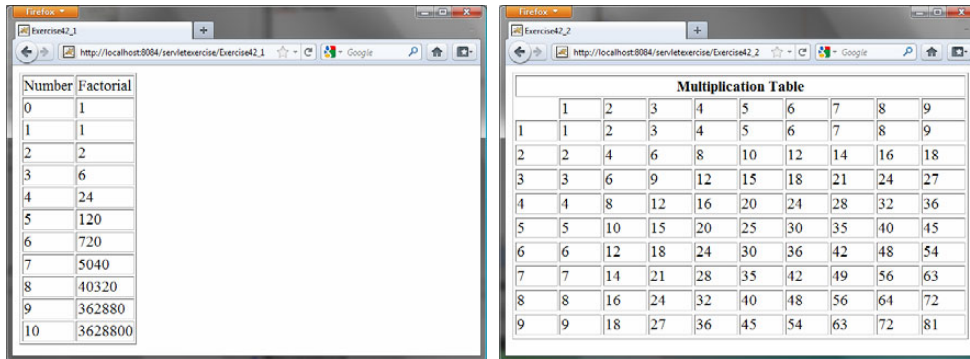
### Programming Exercises

NOTE: Solutions to even-numbered exercises in this chapter are in `exercise\servletexercise` from `evennumberedexercise.zip`, which can be downloaded from the Companion Website.

#### Section 42.5

42.1\*

(Factorial table) Write a servlet to display a table that contains factorials for the numbers from 0 to 10, as shown in Figure 42.28a.



(a)

(b)

Figure 42.28

(a) The servlet displays factorials for the numbers from 0 to 10 in a table. (b) The servlet displays the multiplication table.

42.2\*

(Multiplication table) Write a servlet to display a multiplication table, as shown in Figure 42.28(b).

42.3\*

(Visit count) Develop a servlet that displays the number of visits on the servlet. Also display the client's host name and IP address, as shown in Figure 42.29.

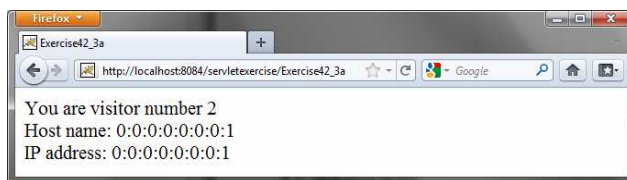


Figure 42.29

The servlet displays the number of visits and the client's host name, IP address, and request URL.

Implement this program in three different ways:

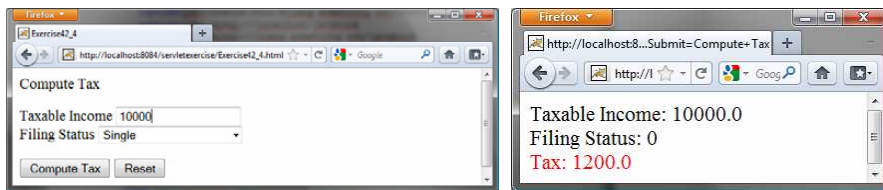
1. Use an instance variable to store `count`. When the servlet is created for the first time, `count` is 0. `count` is incremented every time the servlet's `doGet` method is invoked. When the Web server stops, `count` is lost.



2. Store the count in a file named `Exercise39_3.dat`, and use `RandomAccessFile` to read the count in the servlet's `init` method. The count is incremented every time the servlet's `doGet` method is invoked. When the Web server stops, store the count back to the file.
3. Instead of counting total visits from all clients, count the visits by each client identified by the client's IP address. Use `Map` to store a pair of IP addresses and visit counts. For the first visit, an entry is created in the map. For subsequent visits, the visit count is updated.

Section 42.6  
42.4\*

(Calculate tax) Write an HTML form to prompt the user to enter taxable income and filing status, as shown in Figure 42.30a. Clicking the *Compute Tax* button invokes a servlet to compute and display the tax, as shown in Figure 42.30b. Use the `computeTax` method introduced in Listing 3.7, `ComputingTax.java`, to compute tax.



(a)

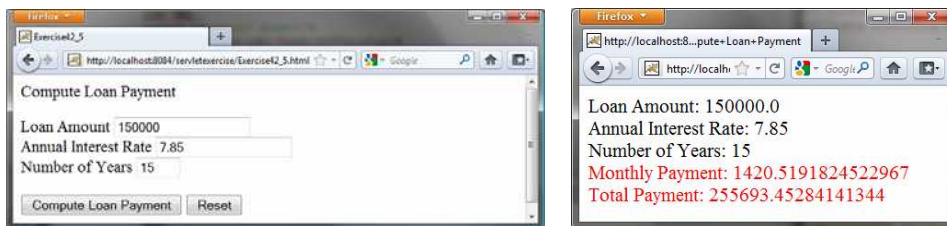
(b)

**Figure 42.30**

*The servlet computes the tax.*

42.5\*

(Calculate loan) Write an HTML form that prompts the user to enter loan amount, interest rate, and number of years, as shown in Figure 42.31a. Clicking the *Compute Loan Payment* button invokes a servlet to compute and display the monthly and total loan payments, as shown in Figure 42.31b. Use the `Loan` class given in Listing 10.2, `Loan.java`, to compute the monthly and total payments.



(a)

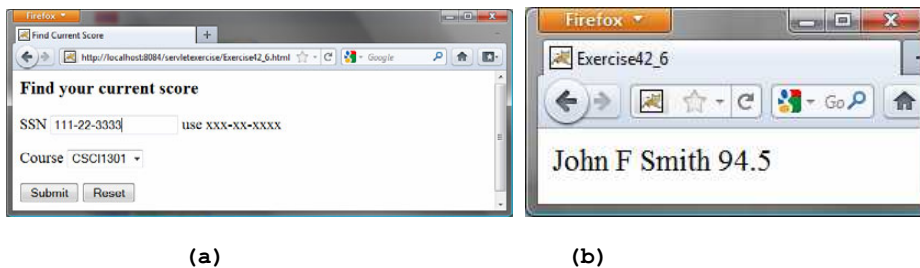
(b)

**Figure 42.31**

The servlet computes the loan payment.

#### 42.6\*\*

(Find scores from text files) Write a servlet that displays the student name and the current score, given the SSN and class ID. For each class, a text file is used to store the student name, SSN, and current score. The file is named after the class ID with .txt extension. For instance, if the class ID were cscil301, the file name would be cscil301.txt. Suppose each line consists of student name, SSN, and score. These three items are separated by the # sign. Create an HTML form that enables the user to enter the SSN and class ID, as shown in Figure 42.32a. Upon clicking the *Submit* button, the result is displayed, as shown in Figure 42.32b. If the SSN or the class ID does not match, report an error. Assume three courses are available: CSC1301, CSC1302, and CSC13720.



**Figure 42.32**

The HTML form accepts the SSN and class ID from the user and sends them to the servlet to obtain the score.

#### Section 42.7

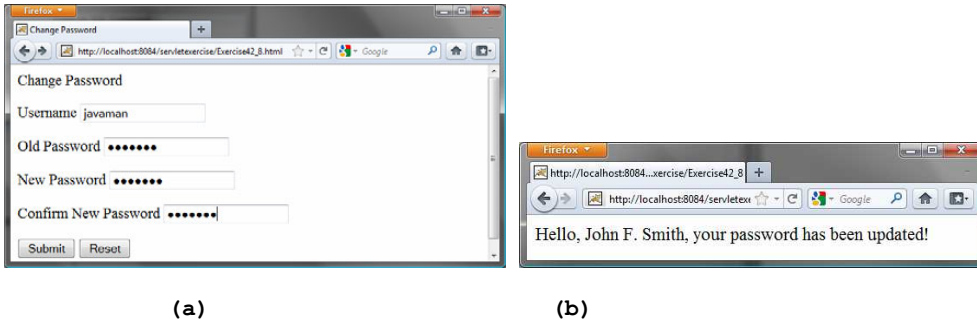
#### 42.7\*\*

(Find scores from database tables) Rewrite the preceding servlet. Assume that for each class, a table is used to store the student name, ssn, and score. The table name is the same as the class ID. For instance, if the class ID were cscil301, the table name would be cscil301.

#### 42.8\*

(Change the password) Write a servlet that enables the user to change the password from an HTML form, as shown in Figure 42.33a. Suppose that the user information is stored in a database table named Account with three columns: username, password, and name, where name is the real name of the user. The servlet performs the following tasks:

- Verify that the username and old password are in the table. If not, report the error and redisplay the HTML form.
- Verify that the new password and the confirmed password are the same. If not, report this error and redisplay the HTML form.
- If the user information is entered correctly, update the password and report the status of the update to the user, as shown in Figure 42.33b.

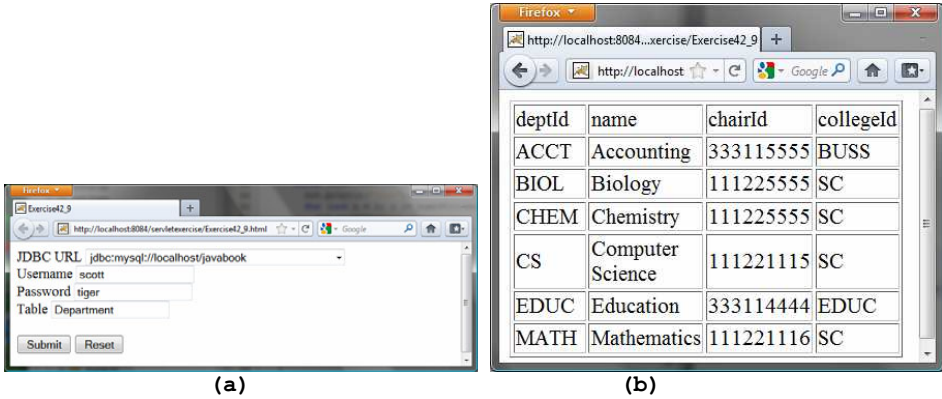


**Figure 42.33**

The user enters the username and the old password and sets a new password. The servlet reports the status of the update to the user.

42.9\*\*

(Display database tables) Write an HTML form that prompts the user to enter or select a JDBC driver, database URL, username, password, and table name, as shown in Figure 42.34a. Clicking the *Submit* button displays the table content, as shown in Figure 42.34b.



**Figure 42.34**

The user enters database information and specifies a table to display its content.

Section 42.8

42.10\*

(Store cookies) Write a servlet that stores the following cookies in a browser, and set their max age for two days.

- Cookie 1: name is "color" and value is red.
- Cookie 2: name is "radius" and value is 5.5.

Cookie 3: name is "count" and value is 2.

42.11\*

(Retrieve cookies) Write a servlet that displays all the cookies on the client. The client types the URL of the servlet from the browser to display all the cookies stored on the browser. See Figure 42.35.

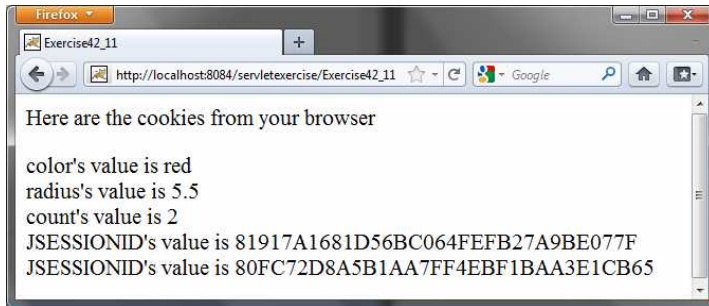


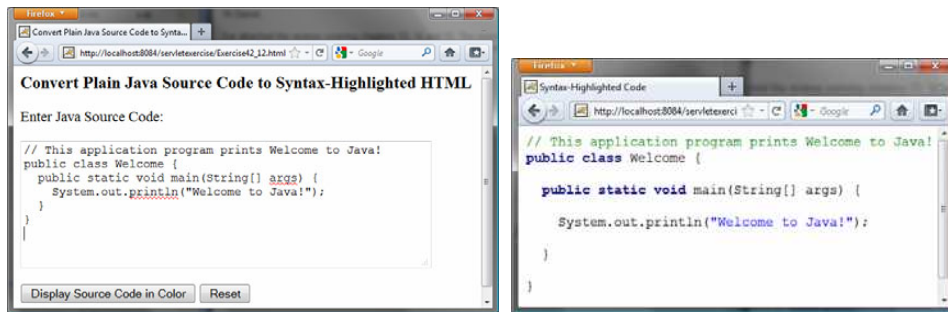
Figure 42.35

All the cookies on the client are displayed in the browser.

### Comprehensive

42.12\*\*\*

(Syntax highlighting) Create an HTML form that prompts the user to enter a Java program in a text area, as shown in Figure 42.36a. The form invokes a servlet that displays the Java source code in a syntax-highlighted HTML format, as shown in Figure 42.36b. The keywords, comments, and literals are displayed in bold navy, green, and blue, respectively.



(a)

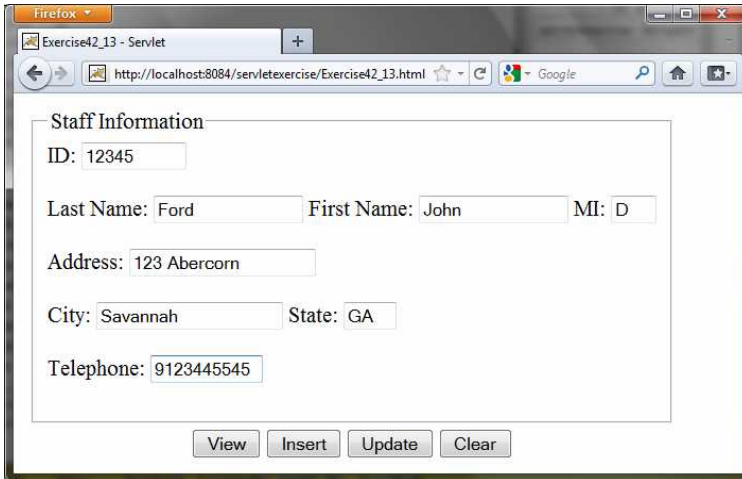
(b)

Figure 42.36

The Java code in plain text in (a) is displayed in HTML with syntax highlighted in (b).

42.13\*\*

(Access and update a Staff table) Write a Java servlet for Exercise 33.1, as shown in Figure 42.37.

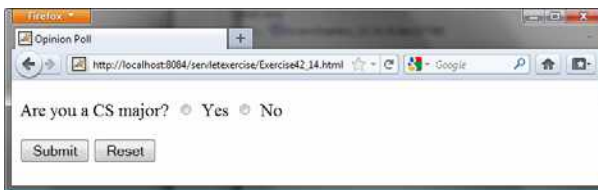


**Figure 42.37**

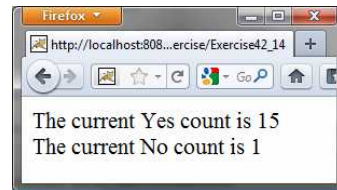
*The web page lets you view, insert, and update staff information.*

#### 42.14\*\*\*

(Opinion poll) Create an HTML form that prompts the user to answer a question such as "Are you a CS major?", as shown in Figure 42.38a. When the *Submit* button is clicked, the servlet increases the Yes or No count in a database and displays the current Yes and No counts, as shown in Figure 42.38b.



(a)



(b)

**Figure 42.38**

*The HTML form prompts the user to enter Yes or No for a question in (a), and the servlet updates the Yes or No counts (b).*

Create a table named Poll, as follows:

```
create table Poll (
 question varchar(40) primary key,
 yesCount int,
 noCount int);
```

Insert one row into the table, as follows:

```
insert into Poll values ('Are you a CS major? ', 0, 0);
```

*\*\*\*This is a bonus Web chapter*

## **CHAPTER 43**

### **JavaServer Pages**

#### Objectives

- To create a simple JSP page (§43.2).
- To explain how a JSP page is processed (§43.3).
- To use JSP constructs to code JSP script (§43.4).
- To use predefined variables and directives in JSP (§§43.5–43.6).
- To use JavaBeans components in JSP (§43.7).
- To get and set JavaBeans properties in JSP (§43.8).
- To associate JavaBeans properties with input parameters (§43.9).
- To forward requests from one JSP page to another (§43.10).
- To develop an application for browsing database tables using JSP (§43.11).

### 43.1 Introduction

Servlets can be used to generate dynamic Web content. One drawback, however, is that you have to embed HTML tags and text inside the Java source code. Using servlets, you have to modify the Java source code and recompile it if changes are made to the HTML text. If you have a lot of HTML script in a servlet, the program is difficult to read and maintain, since the HTML text is part of the Java program. JavaServer Pages (JSP) was introduced to remedy this drawback. JSP enables you to write regular HTML script in the normal way and embed Java code to produce dynamic content.

### 43.2 Creating a Simple JSP Page

**<Side Remark: JSP tag>**

JSP provides an easy way to create dynamic Web pages and simplify the task of building Web applications. A JavaServer page is like a regular HTML page with special tags, known as *JSP tags*, which enable the Web server to generate dynamic content. You can create a Web page with HTML script and enclose the Java code for generating dynamic content in the JSP tags. Here is an example of a simple JSP page.

**<Side Remark line 9: JSP tag>**

```

<!-- CurrentTime.jsp -->
<html>
 <head>
 <title>
 CurrentTime
 </title>
 </head>
 <body>
 Current time is <%= new java.util.Date() %>
 </body>
</html>
```

The dynamic content is enclosed in the tag that begins with `<%=` and ends with `%>`. The current time is returned as a string by invoking the `toString` method of an object of the `java.util.Date` class.

**<Side Remark: JSP in NetBeans>**

An IDE like NetBeans can greatly simplify the task of developing JSP. To create JSP in NetBeans, first you need to create a Web project. A Web project named `liangweb` was created in the preceding chapter. For convenience, this chapter will create JSP in the `liangweb` project.

Here are the steps to create and run `CurrentTime.jsp`:

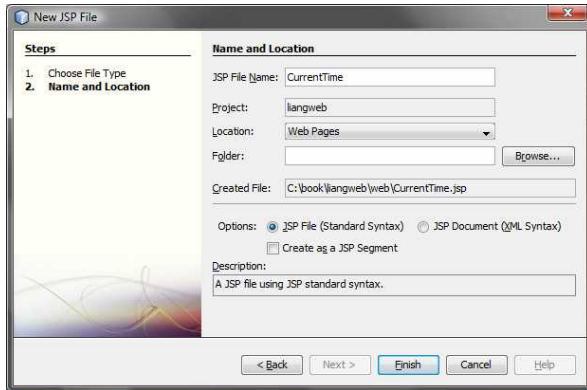
1. Right-click the `liangweb` node in the project pane and choose **New** > **JSP** to display the New JSP dialog box, as shown in Figure 43.1.

**<Side Remark: create CurrentTime.jsp>**

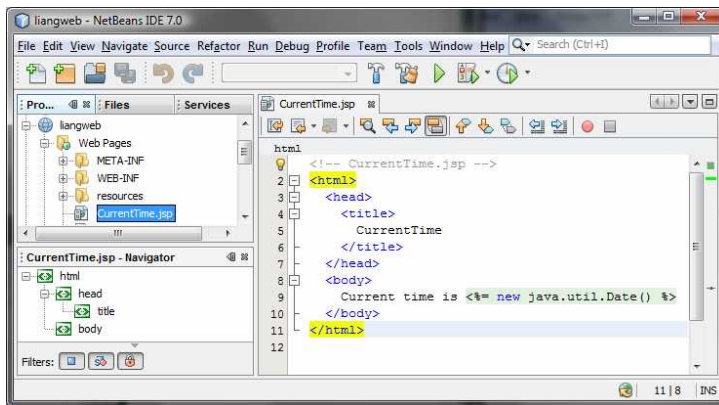
2. Enter `CurrentTime` in the JSP File Name field and click *Finish*. You will see `CurrentTime.jsp` appearing under the Web Pages node in `liangweb`.
3. Complete the code for `CurrentTime.jsp`, as shown in Figure 43.2.

**<Side Remark: run CurrentTime.jsp>**

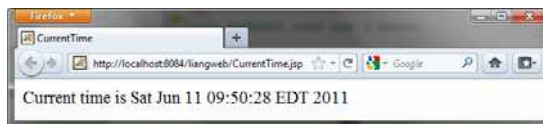
4. Right-click `CurrentTime.jsp` in the project pane and choose **Run File**. You will see the JSP page displayed in a Web browser, as shown in Figure 43.3.



**Figure 43.1**  
You can create a JSP page using NetBeans.



**Figure 43.2**  
A template for a JSP page is created.



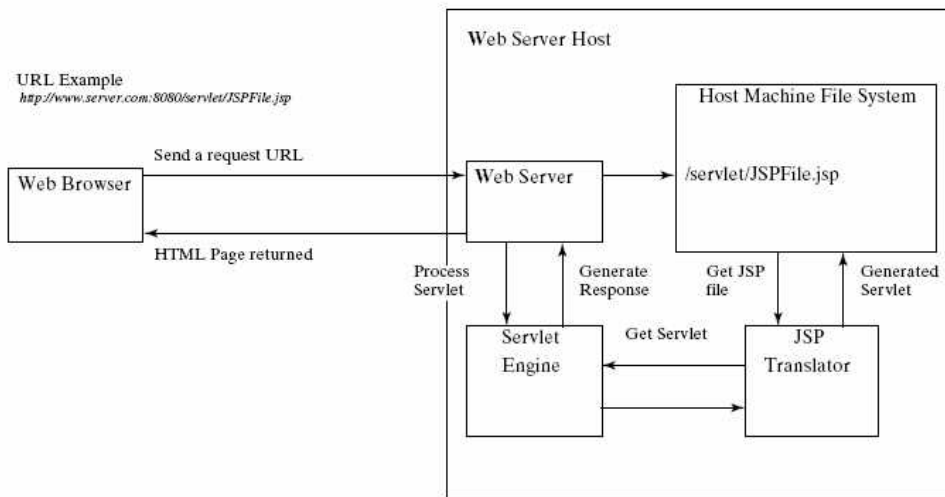
**Figure 43.3**  
The result from a JSP page is displayed in a Web browser.

NOTE: Like servlets, you can develop JSP in NetBeans, create a .war file, and then deploy the .war file in a Java Web server such as Tomcat and GlassFish.

### 43.3 How Is a JSP Page Processed?

A JSP page must first be processed by a Web server before it can be displayed in a Web browser. The Web server must support JSP, and the JSP page must be stored in a file with a .jsp extension. The Web server translates the .jsp file into a Java servlet, compiles the servlet, and executes it. The result of the execution is sent to the browser for display. Figure 43.4 shows how a JSP page is processed by a Web server.





**Figure 43.4**  
A JSP page is translated into a servlet.

NOTE: A JSP page is translated into a servlet when the page is requested for the first time. It is not retranslated if the page is not modified. To ensure that the first-time real user does not encounter a delay, JSP developers should test the page after it is installed.

#### 43.4 JSP Scripting Constructs

<Side Remark: scripting element>

<Side Remark: directive>

<Side Remark: action>

There are three main types of JSP constructs: scripting constructs, directives, and actions. *Scripting* elements enable you to specify Java code that will become part of the resultant servlet. *Directives* enable you to control the overall structure of the resultant servlet. *Actions* enable you to control the behavior of the JSP engine. This section introduces scripting constructs.

Three types of JSP scripting constructs can be used to insert Java code into a resultant servlet: expressions, scriptlets, and declarations.

<Side Remark: JSP expression>

A JSP *expression* is used to insert a Java expression directly into the output. It has the following form:

```
<%= Java expression %>
```

The expression is evaluated, converted into a string, and sent to the output stream of the servlet.

<Side Remark: JSP scriptlet>

A JSP *scriptlet* enables you to insert a Java statement into the servlet's `jspService` method, which is invoked by the `service` method. A JSP scriptlet has the following form:

```
<% Java statement %>
```

**<Side Remark: JSP declaration>**

A JSP *declaration* is for declaring methods or fields into the servlet. It has the following form:

```
<%! Java declaration %>
```

HTML comments have the following form:

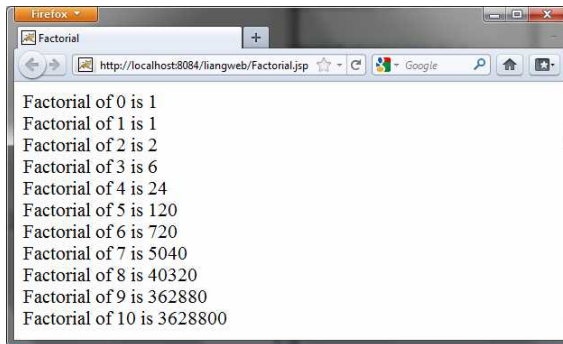
```
<!-- HTML Comment -->
```

**<Side Remark: JSP comment>**

If you don't want the comment to appear in the resultant HTML file, use the following comment in JSP:

```
<%-- JSP Comment --%>
```

Listing 43.1 creates a JavaServer page that displays factorials for numbers from 0 to 10, as shown in Figure 43.5.



**Figure 43.5**  
The JSP page displays factorials.

**Listing 43.1 Factorial.jsp**

**<Side Remark line 9: JSP scriptlet>**  
**<Side Remark line 10: JSP expression>**  
**<Side Remark line 14: JSP declaration>**

```
<html>
 <head>
 <title>
 Factorial
 </title>
 </head>
 <body>

 <% for (int i = 0; i <= 10; i++) { %>
 Factorial of <%= i %> is
 <%= computeFactorial(i) %>

 <% } %>

 <%! private long computeFactorial(int n) {
```

```

 if (n == 0)
 return 1;
 else
 return n * computeFactorial(n - 1);
 }
%>

</body>
</html>

```

JSP scriptlets are enclosed between `<%` and `%>`. Thus

```

 for (int i = 0; i <= 10; i++) {, (line 9)

```

is a scriptlet and as such is inserted directly into the servlet's `jspService` method.

JSP expressions are enclosed between `<%=` and `%>`. Thus

```

 <%= i %>, (line 10)

```

is an expression and is inserted into the output stream of the servlet.

JSP declarations are enclosed between `<%!` and `%>`. Thus

```

 <%! private long computeFactorial(int n) {
 ...
 }
 %>

```

is a declaration that defines methods or fields in the servlet.

What will be different if line 9 is replaced by the two alternatives shown below? Both work fine, but there is an important difference. In (a), `i` is a local variable in the servlet, whereas in (b) `i` is an instance variable when translated to the servlet.

```

<% int i = 0; %>
<% for (; i <= 10; i++) { %>

```

(a)

```

<%! int i; %>
<% for (i = 0; i <= 10; i++) { %>

```

(b)

CAUTION: For JSP the loop body, even though it contains a single statement, must be placed inside braces. It would be wrong to delete the opening brace (`{`) in line 9 and the closing brace (`<% } %>`) in line 12.

CAUTION: There is no semicolon at the end of a JSP expression. For example, `<%= i; %>` is incorrect. But there must be a semicolon for each Java statement in a JSP scriptlet. For example, `<% int i = 0 %>` is incorrect.

CAUTION: JSP and Java elements are case sensitive, but HTML is not.

### 43.5 Predefined Variables

**<Side Remark: JSP implicit object>**

You can use variables in JSP. For convenience, JSP provides eight predefined variables from the servlet environment that can be used with JSP expressions and scriptlets. These variables are also known as *JSP implicit objects*.

**<Side Remark: request>**

request represents the client's request, which is an instance of HttpServletRequest. You can use it to access request parameters and HTTP headers, such as cookies and host name.

<Side Remark: response>

response represents the servlet's response, which is an instance of HttpServletResponse. You can use it to set response type and send output to the client.

<Side Remark: out>

out represents the character output stream, which is an instance of PrintWriter obtained from response.getWriter(). You can use it to send character content to the client.

<Side Remark: session>

session represents the HttpSession object associated with the request, obtained from request.getSession().

<Side Remark: application>

application represents the ServletContext object for storing persistent data for all clients. The difference between session and application is that session is tied to one client, but application is for all clients to share persistent data.

<Side Remark: config>

config represents the ServletConfig object for the page.

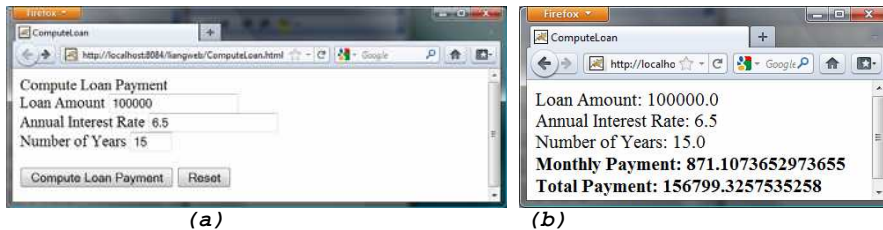
<Side Remark: pageContext>

pageContext represents the PageContext object. PageContext is a new class introduced in JSP to give a central point of access to many page attributes.

<Side Remark: page>

page is an alternative to this.

As an example, let us write an HTML page that prompts the user to enter loan amount, annual interest rate, and number of years, as shown in Figure 43.6a. Clicking the *Compute Loan Payment* button invokes a JSP to compute and display the monthly and total loan payments, as shown in Figure 43.6b.



**Figure 43.6**  
The JSP computes the loan payments.

The HTML file is named `ComputeLoan.html` (Listing 43.2). The JSP file is named `ComputeLoan.jsp` (Listing 43.3).

#### Listing 43.2 `ComputeLoan.html`

```
<Side Remark line 7: form action>
<Side Remark line 10: text field>
<Side Remark line 15: submit>

<!-- ComputeLoan.html -->
<html>
<head>
 <title>ComputeLoan</title>
```

```

</head>
<body>
 <form method = "get" action = "ComputeLoan.jsp">
 Compute Loan Payment

 Loan Amount
 <input type = "text" name = "loanAmount" />

 Annual Interest Rate
 <input type = "text" name = "annualInterestRate" />

 Number of Years
 <input type = "text" name = "numberOfYears" size = "3" />

 <p><input type = "submit" name = "Submit"
 value = "Compute Loan Payment" />
 <input type = "reset" value = "Reset" /></p>
 </form>
</body>
</html>

```

Listing 43.3 ComputeLoan.jsp

<Side Remark line 7: JSP scriptlet>  
 <Side Remark line 8: get parameters>  
 <Side Remark line 17: JSP expression>

```

<!-- ComputeLoan.jsp -->
<html>
 <head>
 <title>ComputeLoan</title>
 </head>
 <body>
 <% double loanAmount = Double.parseDouble(
 request.getParameter("loanAmount"));
 double annualInterestRate = Double.parseDouble(
 request.getParameter("annualInterestRate"));
 double numberOfYears = Integer.parseInt(
 request.getParameter("numberOfYears"));
 double monthlyInterestRate = annualInterestRate / 1200;
 double monthlyPayment = loanAmount * monthlyInterestRate /
 (1 - 1 / Math.pow(1 + monthlyInterestRate, numberOfYears * 12));
 double totalPayment = monthlyPayment * numberOfYears * 12; %>
 Loan Amount: <%= loanAmount %>

 Annual Interest Rate: <%= annualInterestRate %>

 Number of Years: <%= numberOfYears %>

 Monthly Payment: <%= monthlyPayment %>

 Total Payment: <%= totalPayment %>

 </body>
</html>

```

ComputeLoan.html is displayed first to prompt the user to enter the loan amount, annual interest rate, and number of years. Since this file does not contain any JSP elements, it is named with an .html extension as a regular HTML file.

ComputeLoan.jsp is invoked upon clicking the *Compute Loan Payment* button in the HTML form. The JSP page obtains the parameter values using the predefined variable `request` in lines 7-12 and computes monthly payment and total payment in lines 13-16. The formula for computing monthly payment is given in §2.9, "Problem: Computing Loan Payments."

What is wrong if the JSP scriptlet `<%` in line 7 is replaced by the JSP declaration `<%!`? The predefined variables (e.g., `request`, `response`, `out`) correspond to local variables defined in the servlet methods `doGet` and `doPost`. They must appear in JSP scriptlets, not in JSP declarations.

TIP: `ComputeLoan.jsp` can also be invoked using the following query string:  
<http://localhost:8084/liangweb/ComputeLoan.jsp?loanAmount=10000&annualInterestRate=6&numberOfYears=15>.

### 43.6 JSP Directives

A JSP directive is a statement that gives the JSP engine information about the JSP page. For example, if your JSP page uses a Java class from a package other than the `java.lang` package, you have to use a directive to import this package. The general syntax for a JSP directive is shown below:

```
<%@ directive attribute = "value" %>, or
<%@ directive attribute1 = "value1"
 attribute2 = "value2"
 ...
 attributen = "valuen" %>
```

The possible directives are:

- **page** lets you provide information for the page, such as importing classes and setting up content type. The page directive can appear anywhere in the JSP file.
- **include** lets you insert a file into the servlet when the page is translated to a servlet. The `include` directive must be placed where you want the file to be inserted.
- **taglib** lets you define custom tags.

The following are useful attributes for the `page` directive:

- **import** specifies one or more packages to be imported for this page. For example, the directive `<%@ page import="java.util.*, java.text.*" %>` imports `java.util.*` and `java.text.*`.
- **contentType** specifies the content type for the resultant JSP page. By default, the content type is `text/html` for JSP. The default content type for servlets is `text/plain`.
- **session** specifies a `boolean` value to indicate whether the page is part of the session. By default, `session` is `true`.
- **buffer** specifies the output stream buffer size. By default, it is 8KB. For example, the directive `<%@ page buffer="10KB" %>` specifies that the output buffer size is 10KB. The directive `<%@ page buffer="none" %>` specifies that a buffer is not used.
- **autoFlush** specifies a `boolean` value to indicate whether the output buffer should be automatically flushed when it is full or whether an exception should be raised when the buffer overflows. By default, this attribute is `true`. In this case, the buffer attribute cannot be `none`.
- **isThreadSafe** specifies a `boolean` value to indicate whether the page can be accessed simultaneously without data corruption. By default, it is `true`. If it is set to `false`, the JSP page will be translated to a servlet that implements the `SingleThreadModel` interface.
- **errorPage** specifies a JSP page that is processed when an exception occurs in the current page. For example, the directive `<%@ page`

`errorPage="HandleError.jsp" %>` specifies that `HandleError.jsp` is processed when an exception occurs.

- **`isErrorPage`** specifies a `boolean` value to indicate whether the page can be used as an error page. By default, this attribute is `false`.

Listing 43.4 gives an example that shows how to use the `page` directive to import a class. The example uses the `Loan` class created in Listing 10.2, `Loan.java`, to simplify Listing 43.3, `ComputeLoan.jsp`. You can create an object of the `Loan` class and use its `monthlyPayment()` and `totalPayment()` methods to compute the monthly payment and total payment.

#### Listing 43.4 `ComputeLoan1.jsp`

*<Side Remark line 7: JSP directive>*

*<Side Remark line 14: create object>*

```
<!-- ComputeLoan1.jsp -->
<html>
 <head>
 <title>ComputeLoan Using the Loan Class</title>
 </head>
 <body>
 <%@ page import = "chapter43.Loan" %>
 <% double loanAmount = Double.parseDouble(
 request.getParameter("loanAmount"));
 double annualInterestRate = Double.parseDouble(
 request.getParameter("annualInterestRate"));
 int numberOfYears = Integer.parseInt(
 request.getParameter("numberOfYears"));
 Loan loan =
 new Loan(annualInterestRate, numberOfYears, loanAmount);
 %>
 Loan Amount: <%= loanAmount %>

 Annual Interest Rate: <%= annualInterestRate %>

 Number of Years: <%= numberOfYears %>

 Monthly Payment: <%= loan.getMonthlyPayment() %>

 Total Payment: <%= loan.getTotalPayment() %>

 </body>
</html>
```

*<Side Remark: create Loan class>*

This JSP uses the `Loan` class. You need to create the class in the `liangweb` project in package `chapter43` as follows:

```
package chapter43;

public class Loan {
 // Same as lines 2-69 in Listing 10.2, Loan.java, so omitted
}
```

The directive `<%@ page import = "chapter43.Loan" %>` imports the `Loan` class in line 7. Line 14 creates an object of `Loan` for the given loan amount, annual interest rate, and number of years. Lines 20-21 invokes the `Loan` object's `monthlyPayment()` and `totalPayment()` methods to display monthly payment and total payment.

#### 43.7 Using JavaBeans in JSP

Normally you create an instance of a class in a program and use it in that program. This method is for sharing the class, not the object. JSP allows you to share the object of a class among different pages. To enable an object to be shared, its class must be a JavaBeans component. Recall that this entails the following three features:

- The class is public.
- The class has a public constructor with no arguments.
- The class is serializable. (This requirement is not necessary in JSP.)

To create an instance for a JavaBeans component, use the following syntax:

```
<jsp:useBean id = "objectName" scope = "scopeAttribute"
 class = "ClassName" />
```

This syntax is roughly equivalent to

```
<% ClassName objectName = new ClassName() %>
```

except that the scope attribute is missing. The scope attribute specifies the scope of the object and the object is not recreated if it is already within the scope. Listed below are four possible values for the scope attribute:

- **application** specifies that the object is bound to the application. The object can be shared by all sessions of the application.
- **session** specifies that the object is bound to the client's session. Recall that a client's session is automatically created between a Web browser and a Web server. When a client from the same browser accesses two servlets or two JSP pages on the same server, the session is the same.
- **page** is the default scope, which specifies that the object is bound to the page.
- **request** specifies that the object is bound to the client's request.

When <jsp:useBean id="objectName" scope="scopeAttribute" class="ClassName" /> is processed, the JSP engine first searches for an object of the class with the same id and scope. If found, the preexisting bean is used; otherwise, a new bean is created.

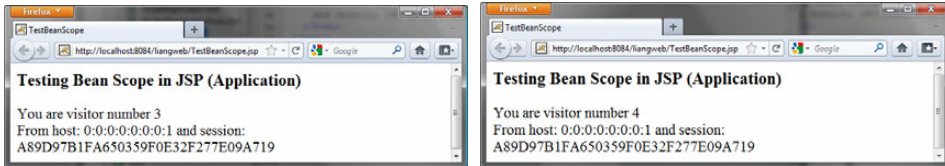
Here is another syntax for creating a bean:

```
<jsp:useBean id = "objectName" scope = "scopeAttribute"
 class = "ClassName" >
 statements
</jsp:useBean>
```

The statements are executed when the bean is created. If a bean with the same ID and class name already exists in the scope, the statements are not executed.

Listing 43.5 creates a JavaBeans component named Count and uses it to count the number of visits to a JSP page, as shown in Figure 43.7.





**Figure 43.7**  
The number of visits to the page is increased when the page is visited.

#### Listing 43.5 Count.java

<Side Remark line 1: package statement>

```
package chapter43;

public class Count {
 private int count = 0;

 /** Return count property */
 public int getCount() {
 return count;
 }

 /** Increase count */
 public void increaseCount() {
 count++;
 }
}
```

The JSP page named TestBeanScope.jsp is created in Listing 43.6.

#### Listing 43.6 TestBeanScope.jsp

<Side Remark line 2: import directive>

<Side Remark line 3: create bean>

<Side Remark line 12: use bean>

<Side Remark line 14: request>

<Side Remark line 15: session>

```
<!-- TestBeanScope.jsp -->
<%@ page import = "chapter43.Count" %>
<jsp:useBean id = "count" scope = "application"
class = "chapter43.Count">
</jsp:useBean>
<html>
<head>
<title>TestBeanScope</title>
</head>
<body>
<h3>Testing Bean Scope in JSP (Application)</h3>
<% count.increaseCount(); %>
You are visitor number <%= count.getCount() %>

From host: <%= request.getRemoteHost() %>
and session: <%= session.getId() %>
</body>
</html>
```

The `scope` attribute specifies the scope of the bean. `scope="application"` (line 3) specifies that the bean is alive in the JSP engine and available for all clients to access. The bean can be shared by any client with the directive `<jsp:useBean id="count" scope="application" class="Count" >` (lines 3-4). Every client accessing `TestBeanScope.jsp` causes the count to increase by 1. The first client causes `count` object to be created, and subsequent access to `TestBeanScope` uses the same object.

If `scope="application"` is changed to `scope="session"`, the scope of the bean is limited to the session from the same browser. The count will increase only if the page is requested from the same browser. If `scope="application"` is changed to `scope="page"`, the scope of the bean is limited to the page, and any other page cannot access this bean. The page will always display count 1. If `scope="application"` is changed to `scope="request"`, the scope of the bean is limited to the client's request, and any other request on the page will always display count 1.

If the page is destroyed, the count restarts from 0. You can fix the problem by storing the count in a random access file or in a database table. Assume that you store the count in the `Count` table in a database. The `Count` class can be modified in Listing 43.7.

#### Listing 43.7 Count.java (Revised Version)

*<Side Remark line 1: package statement>*

*<Side Remark line 16: execute SQL>*

*<Side Remark line 43: load driver>*

*<Side Remark line 46: connection>*

*<Side Remark line 49: statement>*

```
package chapter43;

import java.sql.*;

public class Count {
 private int count = 0;
 private Statement statement = null;

 public Count() {
 initializeJdbc();
 }

 /** Return count property */
 public int getCount() {
 try {
 ResultSet rset = statement.executeQuery
 ("select countValue from Count");
 rset.next();
 count = rset.getInt(1);
 }
 catch (Exception ex) {
 ex.printStackTrace();
 }

 return count;
 }

 /** Increase count */
```

```

public void increaseCount() {
 count++;
 try {
 statement.executeUpdate(
 "update Count set countValue = " + count);
 }
 catch (Exception ex) {
 ex.printStackTrace();
 }
}

/** Initialize database connection */
public void initializeJdbc() {
 try {
 Class.forName("com.mysql.jdbc.Driver");

 // Connect to the sample database
 Connection connection = DriverManager.getConnection
 ("jdbc:mysql://localhost/javabook" , "scott", "tiger");

 statement = connection.createStatement();
 }
 catch (Exception ex) {
 ex.printStackTrace();
 }
}
}

```

### 43.8 Getting and Setting Properties

By convention, a JavaBeans component provides the get and set methods for reading and modifying its private properties. You can get the property in JSP using the syntax shown below:

```
<jsp:getProperty name = "beanId" property = "sample" />
```

This is roughly equivalent to

```
<%= beanId.getSample() %>
```

You can set the property in JSP using the following syntax:

```
<jsp:setProperty name = "beanId"
 property = "sample" value = "test1" />
```

This is equivalent to

```
<% beanId.setSample("test1"); %>
```

### 43.9 Associating Properties with Input Parameters

Often properties are associated with input parameters. Suppose you want to get the value of the input parameter named score and set it to the JavaBeans property named score. You could write the following code:

```
<% double score = Double.parseDouble(
 request.getParameter("score")); %>
<jsp:setProperty name = "beanId" property = "score"
 value = "<%= score %>" />
```

This is cumbersome. JSP provides a convenient syntax that can be used to simplify it:

```
<jsp:setProperty name = "beanId" property = "score"
 param = "score" />
```

Instead of using the `value` attribute, you use the `param` attribute to name an input parameter. The value of this parameter is set to the property.

NOTE: Simple type conversion is performed automatically when a bean property is associated with an input parameter. A string input parameter is converted to an appropriate primitive data type or a wrapper class for a primitive type. For example, if the bean property is of the `int` type, the value of the parameter will be converted to the `int` type. If the bean property is of the `Integer` type, the value of the parameter will be converted to the `Integer` type.

Often the bean property and the parameter have the same name. You can use the following convenient statement to associate all the bean properties in `beanId` with the parameters that match the property names:

```
<jsp:setProperty name = "beanId" property = "*" />
```

#### 43.9.1 Example: Computing Loan Payments Using JavaBeans

This example uses JavaBeans to simplify Listing 43.4, `ComputeLoan1.jsp`, by associating the bean properties with the input parameters. The new `ComputeLoan2.jsp` is given in Listing 43.8.

#### Listing 43.8 `ComputeLoan2.jsp`

*<Side Remark line 7: import>*  
*<Side Remark line 8: create bean>*  
*<Side Remark line 11: use bean>*

```
<!-- ComputeLoan2.jsp -->
<html>
 <head>
 <title>ComputeLoan Using the Loan Class</title>
 </head>
 <body>
 <%@ page import = "chapter43.Loan" %>
 <jsp:useBean id = "loan" class = "chapter43.Loan"
 scope = "page" ></jsp:useBean>
 <jsp:setProperty name = "loan" property = "*" />
 Loan Amount: <%= loan.getLoanAmount() %>

 Annual Interest Rate: <%= loan.getAnnualInterestRate() %>

 Number of Years: <%= loan.getNumberofYears() %>

 Monthly Payment: <%= loan.monthlyPayment() %>

 Total Payment: <%= loan.totalPayment() %>

 </body>
</html>
```

Lines 8-9

```
<jsp:useBean id = "loan" class = "chapter43.Loan"
 scope = "page" ></jsp:useBean>
```

creates a bean named `loan` for the `Loan` class. Line 10

```
<jsp:setProperty name = "loan" property = "*" />
```

associates the bean properties `loanAmount`, `annualInterestRate`, and `numberOfYears` with the input parameter values and performs type conversion automatically.

Lines 11-13 use the accessor methods of the loan bean to get the loan amount, annual interest rate, and number of years.

This program acts the same as in Listings 43.3 and 43.4, `ComputeLoan.jsp` and `ComputeLoan1.jsp`, but the coding is much simplified.

#### 43.9.2 Example: Computing Factorials Using JavaBeans

This example creates a JavaBeans component named `FactorialBean` and uses it to compute the factorial of an input number in a JSP page named `FactorialBean.jsp`, as shown in Figure 43.8.



**Figure 43.8**

*The factorial of an input integer is computed using a method in `FactorialBean`.*

Create a JavaBeans component named `FactorialBean.java` (Listing 43.9). Create `FactorialBean.jsp` (Listing 43.10).

#### Listing 43.9 `FactorialBean.java`

<Side Remark line 1: package statement>

<Side Remark line 7: get>

<Side Remark line 12: set>

```
package chapter43;

public class FactorialBean {
 private int number;

 /** Return number property */
 public int getNumber() {
 return number;
 }

 /** Set number property */
 public void setNumber(int newValue) {
 number = newValue;
 }
}
```

```

 /** Obtain factorial */
 public long getFactorial() {
 long factorial = 1;
 for (int i = 1; i <= number; i++)
 factorial *= i;
 return factorial;
 }
}

```

Listing 43.10 FactorialBean.jsp

<Side Remark line 2: import>  
 <Side Remark line 3: create bean>  
 <Side Remark line 15: form>  
 <Side Remark line 21: get property>

```

<!-- FactorialBean.jsp -->
<%@ page import = "chapter43.FactorialBean" %>
<jsp:useBean id = "factorialBeanId"
 class = "chapter43.FactorialBean" scope = "page" >
</jsp:useBean>
<jsp:setProperty name = "factorialBeanId" property = "*" />
<html>
 <head>
 <title>
 FactorialBean
 </title>
 </head>
 <body>
 <h3>Compute Factorial Using a Bean</h3>
 <form method = "post">
 Enter new value: <input name = "number" />

 <input type = "submit" name = "Submit"
 value = "Compute Factorial" />
 <input type = "reset" value = "Reset" />

 Factorial of
 <jsp:getProperty name = "factorialBeanId"
 property = "number" /> is
 <%@ page import = "java.text.*" %>
 <% NumberFormat format = NumberFormat.getNumberInstance(); %>
 <%= format.format(factorialBeanId.getFactorial()) %>
 </form>
 </body>
</html>

```

The `jsp:useBean` tag (lines 3-4) creates a bean `factorialBeanId` of the `FactorialBean` class. Line 5 `<jsp:setProperty name="factorialBeanId" property="*" />` associates all the bean properties with the input parameters that have the same name. In this case, the bean property `number` is associated with the input parameter `number`. When you click the `Compute Factorial` button, JSP automatically converts the input value for `number` from string into `int` and sets it to `factorialBean` before other statements are executed.

Lines 21-22 `<jsp:getProperty name="factorialBeanId" property="number" />` tag (line 21) is equivalent to `<%= factorialBeanId.getNumber() %>`. The

method `factorialBeanId.getFactorial()` (line 25) returns the factorial for the number in `factorialBeanId`.

#### DESIGN GUIDE

*<Side Remark: separating Java code from HTML>*

Mixing a lot of Java code with HTML in a JSP page makes the code difficult to read and to maintain. You should move the Java code to a .java file as much as you can.

*\*\*\*End DESIGN GUIDE*

Following the preceding design guide, you may improve the preceding example by moving the Java code in lines 23-25 to the `FactorialBean` class. The new `FactorialBean.java` and `FactorialBean.jsp` are given in Listings 43.11 and 43.12.

#### Listing 43.11 NewFactorialBean.java

*<Side Remark line 1: package statement>*

*<Side Remark line 9: get>*

*<Side Remark line 14: set>*

```
package chapter43;

import java.text.*;

public class NewFactorialBean {
 private int number;

 /** Return number property */
 public int getNumber() {
 return number;
 }

 /** Set number property */
 public void setNumber(int newValue) {
 number = newValue;
 }

 /** Obtain factorial */
 public long getFactorial() {
 long factorial = 1;
 for (int i = 1; i <= number; i++)
 factorial *= i;
 return factorial;
 }

 /** Format number */
 public static String format(long number) {
 NumberFormat format = NumberFormat.getNumberInstance();
 return format.format(number);
 }
}
```

#### Listing 43.12 NewFactorialBean.jsp

*<Side Remark line 2: import>*

*<Side Remark line 3: create bean>*

*<Side Remark line 15: form>*

*<Side Remark line 21: get property>*

```

<!-- NewFactorialBean.jsp -->
<%@ page import = "chapter43.NewFactorialBean" %>
<jsp:useBean id = "factorialBeanId"
 class = "chapter43.NewFactorialBean" scope = "page" >
</jsp:useBean>
<jsp:setProperty name = "factorialBeanId" property = "*" />
<html>
 <head>
 <title>
 FactorialBean
 </title>
 </head>
 <body>
 <h3>Compute Factorial Using a Bean</h3>
 <form method = "post">
 Enter new value: <input name = "number" />

 <input type = "submit" name = "Submit"
 value = "Compute Factorial" />
 <input type = "reset" value = "Reset" />

 Factorial of
 <jsp:getProperty name = "factorialBeanId"
 property = "number" /> is
 <%= NewFactorialBean.format(factorialBeanId.getFactorial()) %>
 </form>
 </body>
</html>

```

There is a problem in this page. The program cannot display large factorials. For example, if you entered value 21, the program would display an incorrect factorial. To fix this problem, all you need to do is to revise the `NewFactorialBean` class using `BigInteger` to computing factorials. See Exercise 43.18.

### 43.9.3 Example: Displaying International Time

Listing 42.5, `TimeForm.java`, gives a Java servlet that uses the `doGet` method to generate an HTML form for the user to specify a locale and time zone (Figure 42.18a) and uses the `doPost` method to display the current time for the specified time zone in the specified locale (Figure 42.18b). This section rewrites the servlet using JSP. You have to create two JSP pages, one for displaying the form and the other for displaying the current time.

In the `TimeForm.java` servlet, arrays `allLocale` and `allTimeZone` are the data fields. The `doGet` and `doPost` methods both use the arrays. Since the available locales and time zones are used in both pages, it is better to create an object that contains all available locales and time zones. This object can be shared by both pages.

Let us create a JavaBeans component named `TimeBean.java` (Listing 43.13). This class obtains all the available locales in an array in line 7 and all time zones in an array in line 8. The bean properties `localeIndex` and `timeZoneIndex` (lines 9-10) are defined to refer to an element in the arrays. The `currentTimeString()` method (lines 42-52) returns a string for the current time with the specified locale and time zone.

### Listing 43.13 TimeBean.java



<Side Remark line 1: package statement>  
 <Side Remark line 7: all locales>  
 <Side Remark line 8: all time zones>  
 <Side Remark line 9: locale index>  
 <Side Remark line 10: time zone index>  
 <Side Remark line 13: sort time zone>  
 <Side Remark line 17: return all locales>  
 <Side Remark line 21: return all time zones>  
 <Side Remark line 42: return current time>

```

package chapter43;

import java.util.*;
import java.text.*;

public class TimeBean {
 private Locale[] allLocale = Locale.getAvailableLocales();
 private String[] allTimeZone = TimeZone.getAvailableIDs();
 private int localeIndex;
 private int timeZoneIndex;

 public TimeBean() {
 Arrays.sort(allTimeZone);
 }

 public Locale[] getAllLocale() {
 return allLocale;
 }

 public String[] getAllTimeZone() {
 return allTimeZone;
 }

 public int getLocaleIndex() {
 return localeIndex;
 }

 public int getTimeZoneIndex() {
 return timeZoneIndex;
 }

 public void setLocaleIndex(int index) {
 localeIndex = index;
 }

 public void setTimeZoneIndex(int index) {
 timeZoneIndex = index;
 }

 /** Return a string for the current time
 * with the specified locale and time zone */
 public String currentTimeString(
 int localeIndex, int timeZoneIndex) {
 Calendar calendar =
 new GregorianCalendar(allLocale[localeIndex]);
 TimeZone timeZone =
 TimeZone.getTimeZone(allTimeZone[timeZoneIndex]);
 DateFormat dateFormat = DateFormat.getDateInstance(
 DateFormat.FULL, DateFormat.FULL, allLocale[localeIndex]);
 dateFormat.setTimeZone(timeZone);
 }

```

```

 return dateFormat.format(calendar.getTime());
 }
}

```

Create `DisplayTimeForm.jsp` (Listing 43.14). This page displays a form just like the one shown in Figure 42.18a. Line 2 imports the `TimeBean` class. A bean is created in lines 3-5 and is used in lines 17, 19, 24, and 26 to return all locales and time zones. The scope of the bean is application (line 4), so the bean can be shared by all sessions of the application.

#### Listing 43.14 `DisplayTimeForm.jsp`

<Side Remark line 2: `import class`>

<Side Remark line 3: `timeBeanId`>

<Side Remark line 15: `action`>

<Side Remark line 19: `all locales`>

<Side Remark line 26: `all time zones`>

```

<!-- DisplayTimeForm.jsp -->
<%@ page import = "chapter43.TimeBean" %>
<jsp:useBean id = "timeBeanId"
 class = "chapter43.TimeBean" scope = "application" >
</jsp:useBean>

<html>
 <head>
 <title>
 Display Time Form
 </title>
 </head>
 <body>
 <h3>Choose locale and time zone</h3>
 <form method = "post" action = "DisplayTime.jsp">
 Locale <select size = "1" name = "localeIndex">
 <% for (int i = 0; i < timeBeanId.getAllLocale().length; i++) {%>
 <option value = "<%= i %>">
 <%= timeBeanId.getAllLocale()[i] %>
 </option>
 <%}%>
 </select>

 Time Zone <select size = "1" name = "timeZoneIndex">
 <% for (int i = 0; i < timeBeanId.getAllTimeZone().length; i++) {%>
 <option value = "<%= i %>">
 <%= timeBeanId.getAllTimeZone()[i] %>
 </option>
 <%}%>
 </select>

 <input type = "submit" name = "Submit"
 value = "Get Time" />
 <input type = "reset" value = "Reset" />
 </form>
 </body>
</html>

```

Create `DisplayTime.jsp` (Listing 43.15). This page is invoked from `DisplayTimeForm.jsp` to display the time with the specified locale and time zone, just as in Figure 42.18b.

#### Listing 43.15 `DisplayTime.jsp`

```
<Side Remark line 2: page encoding>
<Side Remark line 3: import>
<Side Remark line 4: timeBeanId>
<Side Remark line 7: get parameter>
<Side Remark line 18: use object>

<!-- DisplayTime.jsp -->
<%@page pageEncoding = "GB18030"%>
<%@ page import = "chapter43.TimeBean" %>
<jsp:useBean id = "timeBeanId"
 class = "chapter43.TimeBean" scope = "application" >
</jsp:useBean>
<jsp:setProperty name = "timeBeanId" property = "*" />

<html>
 <head>
 <title>
 Display Time
 </title>
 </head>
 <body>
 <h3>Choose locale and time zone</h3>
 Current time is
 <%= timeBeanId.currentTimeString(timeBeanId.getLocaleIndex(),
 timeBeanId.getTimeZoneIndex()) %>
 </body>
</html>
```

Line 2 sets the character encoding for the page to GB18030 for displaying international characters. By default, it is UTF-8.

Line 5 imports `chapter43.TimeBean` and creates a bean using the same id as in the preceding page. Since the object is already created in the preceding page, the `timeBeanId` in this page (lines 4-6) and in the preceding page point to the same object.

#### 43.9.4 Example: Registering Students

Listing 42.11, `RegistrationWithHttpSession.java`, gives a Java servlet that obtains student information from an HTML form (see Figure 42.21) and displays the information for user confirmation (see Figure 42.22). Once the user confirms it, the servlet stores the data into the database. This section rewrites the servlet using JSP. You will create two JSP pages, one named `GetRegistrationData.jsp` for displaying the data for user confirmation and the other named `StoreData.jsp` for storing the data into the database.

Since every session needs to connect to the same database, you should declare a class for connecting to the database and for storing a student to the database. This class named `StoreData` is given in Listing 43.16. The `initializeJdbc` method (lines 15-31) connects to the database and

creates a prepared statement for storing a record to the Address table. The `storeStudent` method (lines 34-45) executes the prepared statement to store a student address. The `Address` class is created in Listing 42.12.

#### Listing 43.16 StoreData.java

<Side Remark line 15: initialize DB>

<Side Remark line 32: store student>

```
package chapter43;

import java.sql.*;
import chapter42.Address;

public class StoreData {
 // Use a prepared statement to store a student into the database
 private PreparedStatement pstmt;

 public StoreData() {
 initializeJdbc();
 }

 /** Initialize database connection */
 private void initializeJdbc() {
 try {
 Class.forName("com.mysql.jdbc.Driver");

 // Connect to the sample database
 Connection connection = DriverManager.getConnection
 ("jdbc:mysql://localhost/javabook", "scott", "tiger");

 // Create a Statement
 pstmt = connection.prepareStatement("insert into Address " +
 "(lastName, firstName, mi, telephone, email, street, city, " +
 "state, zip) values (?, ?, ?, ?, ?, ?, ?, ?, ?)");
 }
 catch (Exception ex) {
 System.out.println(ex);
 }
 }

 /** Store a student record to the database */
 public void storeStudent(Address address) throws SQLException {
 pstmt.setString(1, address.getLastName());
 pstmt.setString(2, address.getFirstName());
 pstmt.setString(3, address.getMi());
 pstmt.setString(4, address.getTelephone());
 pstmt.setString(5, address.getEmail());
 pstmt.setString(6, address.getStreet());
 pstmt.setString(7, address.getCity());
 pstmt.setString(8, address.getState());
 pstmt.setString(9, address.getZip());
 pstmt.executeUpdate();
 }
}
```

The HTML file that displays the form is identical to [Registration.html](#) in Listing 42.8 except that the action is replaced by [GetRegistrationData.jsp](#).

[GetRegistrationData.jsp](#), which obtains the data from the form, is shown in Listing 43.17. A bean is created in lines 3-4. Line 5 obtains the property values from the form. This is a shorthand notation. Note that the parameter names and the property names must be the same to use this notation.

#### Listing 43.17 GetRegistrationData.jsp

<Side Remark line 2: `import`>

<Side Remark line 3: `addressId`>

<Side Remark line 5: `get property values`>

```
<!-- GetRegistrationData.jsp -->
<%@ page import = "chapter42.Address" %>
<jsp:useBean id = "addressId"
 class = "chapter42.Address" scope = "session"></jsp:useBean>
<jsp:setProperty name = "addressId" property = "*" />

<html>
 <body>
 <h1>Registration Using JSP</h1>

 <%
 if (addressId.getLastName() == null ||
 addressId.getFirstName() == null) {
 out.println("Last Name and First Name are required");
 return; // End the method
 }
 %>

 <p>You entered the following data</p>
 <p>Last name: <%= addressId.getLastName() %></p>
 <p>First name: <%= addressId.getFirstName() %></p>
 <p>MI: <%= addressId.getMi() %></p>
 <p>Telephone: <%= addressId.getTelephone() %></p>
 <p>Email: <%= addressId.getEmail() %></p>
 <p>Address: <%= addressId.getStreet() %></p>
 <p>City: <%= addressId.getCity() %></p>
 <p>State: <%= addressId.getState() %></p>
 <p>Zip: <%= addressId.getZip() %></p>

 <!-- Set the action for processing the answers -->
 <form method = "post" action = "StoreStudent.jsp">
 <input type = "submit" value = "Confirm">
 </form>
 </body>
</html>
```

[GetRegistrationData.jsp](#) invokes [StoreStudent.jsp](#) (line 31) when the user clicks the *Confirm* button. In Listing 43.18, the same `addressId` is shared with the preceding page within the scope of the same session in lines 3-4. A bean for [StoreData](#) is created in lines 5-6 with the scope of application.

### Listing 43.18 StoreStudent.jsp

<Side Remark line 2: import>  
<Side Remark line 3: addressId>  
<Side Remark line 5: storeDataId>

```
<!-- StoreStudent.jsp -->
<%@ page import = "chapter42.Address" %>
<jsp:useBean id = "addressId" class = "chapter42.Address"
 scope = "session"></jsp:useBean>
<jsp:useBean id = "storeDataId" class = "chapter43.StoreData"
 scope = "application"></jsp:useBean>

<html>
 <body>
 <%
 storeDataId.storeStudent(addressId);

 out.println(addressId.getFirstName() + " " +
 addressId.getLastName() +
 " is now registered in the database");
 out.close(); // Close stream
 %>
 </body>
</html>
```

NOTE

<Side Remark: appropriate scopes>

The scope for addressId is *session*, but the scope for storeDataId is *application*. Why? GetRegistrationData.jsp obtains student information, and StoreData.jsp stores the information in the same session. So the *session* scope is appropriate for addressId. All the sessions access the same database and use the same prepared statement to store data. With the *application* scope for storeDataId, the bean for StoreData needs to be created just once.

NOTE

<Side Remark: exceptions>

The storeStudent method in line 11 may throw a java.sql.SQLException. In JSP, you can omit the try-block for checked exceptions. In case of an exception, JSP displays an error page.

TIP

<Side Remark: using beans>

Using beans is an effective way to develop JSP. You should put Java code into a bean as much as you can. The bean not only simplifies JSP programming, but also makes code reusable. The bean can also be used to implement persistent sessions.

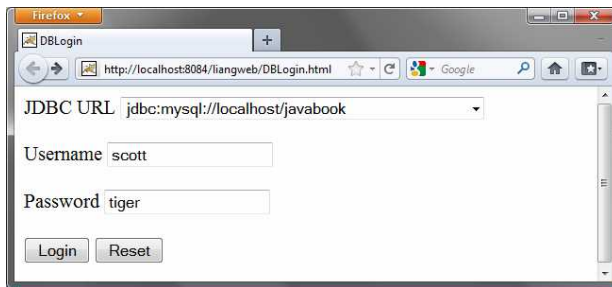
### 43.10 Forwarding Requests from JavaServer Pages

Web applications developed using JSP generally consist of many pages linked together. JSP provides a forwarding tag in the following syntax that can be used to forward a page to another page:

```
<jsp:forward page = "destination" />
```

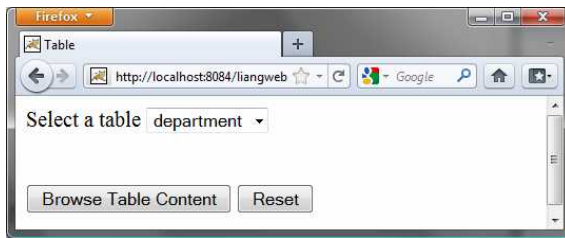
### 43.11 Case Study: Browsing Database Tables

This section presents a very useful JSP application for browsing tables. When you start the application, the first page prompts the user to enter the JDBC driver, URL, username, and password for a database, as shown in Figure 43.9. After you log in to the database, you can select a table to browse, as shown in Figure 43.10. Clicking the *Browse Table Content* button displays the table content, as shown in Figure 43.11.



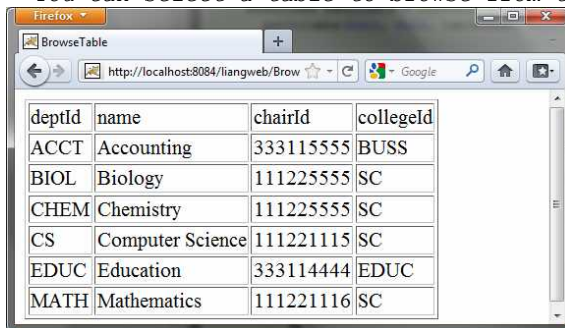
**Figure 43.9**

To access a database, you need to provide the JDBC driver, URL, username, and password.



**Figure 43.10**

You can select a table to browse from this page.



**Figure 43.11**

The contents of the selected table are displayed.

Create a JavaBeans component named DBBean.java (Listing 43.19).

Listing 43.19 DBBean.java

<Side Remark line 16: load driver>  
<Side Remark line 19: connect db>  
<Side Remark line 33: get tables>  
<Side Remark line 51: return table names>  
<Side Remark line 55: getConnection()>  
<Side Remark line 59: userName>  
<Side Remark line 67: password>  
<Side Remark line 79: driver>  
<Side Remark line 83: url>

```
package chapter43;

import java.sql.*;

public class DBBean {
 private Connection connection = null;
 private String username;
 private String password;
 private String driver;
 private String url;

 /** Initialize database connection */
 public void initializeJdbc() {
 try {
 System.out.println("Driver is " + driver);
 Class.forName(driver);

 // Connect to the sample database
 connection = DriverManager.getConnection(url, username,
 password);
 }
 catch (Exception ex) {
 ex.printStackTrace();
 }
 }

 /** Get tables in the database */
 public String[] getTables() {
 String[] tables = null;

 try {
 DatabaseMetaData dbMetaData = connection.getMetaData();
 ResultSet rsTables = dbMetaData.getTables(null, null, null,
 new String[] {"TABLE"});

 int size = 0;
 while (rsTables.next()) size++;

 rsTables = dbMetaData.getTables(null, null, null,
 new String[] {"TABLE"});

 tables = new String[size];
 int i = 0;
 while (rsTables.next())
 tables[i++] = rsTables.getString("TABLE NAME");
 }
 catch (Exception ex) {
```



```

 ex.printStackTrace();
 }

 return tables;
}

/** Return connection property */
public Connection getConnection() {
 return connection;
}

public void setUsername(String newUsername) {
 username = newUsername;
}

public String getUsername() {
 return username;
}

public void setPassword(String newPassword) {
 password = newPassword;
}

public String getPassword() {
 return password;
}

public void setDriver(String newDriver) {
 driver = newDriver;
}

public String getDriver() {
 return driver;
}

public void setUrl(String newUrl) {
 url = newUrl;
}

public String getUrl() {
 return url;
}
}

```

Create an HTML file named `DBLogin.html` (Listing 43.20) that prompts the user to enter database information and three JSP files named `DBLoginInitialization.jsp` (Listing 43.21), `Table.jsp` (Listing 43.22), and `BrowseTable.jsp` (Listing 43.23) to process and obtain database information.

#### Listing 43.20 DBLogin.html

```

<Side Remark line 9: form action>
<Side Remark line 12: combo box>
<Side Remark line 18: submit>

```

```

<!-- DBLogin.html -->
<html>
 <head>
 <title>

```

```

 DBLogin
 </title>
</head>
<body>
 <form method = "post" action = "DBLoginInitialization.jsp">
 JDBC URL
 <select name = "url" size = "1">
 <option>jdbc:odbc:ExampleMDBDataSource</option>
 <option>jdbc:mysql://localhost/javabook</option>
 <option>jdbc:oracle:thin:@liang.armstrong.edu:1521:orcl</option>
 </select>

 Username <input name = "username" />

 Password <input name = "password" />

 <input type = "submit" name = "Submit" value = "Login" />
 <input type = "reset" value = "Reset" />
 </form>
</body>
</html>

```

Listing 43.21 DBLoginInitialization.jsp

```

<Side Remark line 2: import>
<Side Remark line 3: create bean>
<Side Remark line 14: connect db>
<Side Remark line 17: report error>
<Side Remark line 20: get tables>

<!-- DBLoginInitialization.jsp -->
<%@ page import = "chapter43.DBBean" %>
<jsp:useBean id = "dBBeanId" scope = "session"
 class = "chapter43.DBBean">
</jsp:useBean>
<jsp:setProperty name = "dBBeanId" property = "*" />
<html>
 <head>
 <title>DBLoginInitialization</title>
 </head>
 <body>

 <!-- Connect to the database -->
 <% dBBeanId.initializeJdbc(); %>

 <% if (dBBeanId.getConnection() == null) { %>
 Error: Login failed. Try again.
 <% }
 else {%>
 <jsp:forward page = "Table.jsp" />
 <% } %>
 </body>
</html>

```

Listing 43.22 Table.jsp

```

<Side Remark line 2: import>
<Side Remark line 3: get bean>
<Side Remark line 11: get tables>
<Side Remark line 16: create form>

```

```

<!-- Table.jsp -->
<%@ page import = "chapter43.DBBean" %>
<jsp:useBean id = "dbBeanId" scope = "session"
 class = "chapter43.DBBean">
</jsp:useBean>
<html>
 <head>
 <title>Table</title>
 </head>
 <body>
 <% String[] tables = dbBeanId.getTables();
 if (tables == null) { %>
 No tables
 <% }
 else { %>
 <form method = "post" action = "BrowseTable.jsp">
 Select a table
 <select name = "tablename" size = "1">
 <% for (int i = 0; i < tables.length; i++) { %>
 <option><%= tables[i] %></option>
 <% }
 } %>
 </select>

 <input type = "submit" name = "Submit"
 value = "Browse Table Content">
 <input type = "reset" value = "Reset">
 </form>
 </body>
 </html>

```

Listing 43.23 BrowseTable.jsp

```

<Side Remark line 2: import>
<Side Remark line 3: get bean>
<Side Remark line 13: get table name>
<Side Remark line 15: table column>
<Side Remark line 21: column names>
<Side Remark line 28: table content>
<Side Remark line 35: display content>

```

```

<!-- BrowseTable.jsp -->
<%@ page import = "chapter43.DBBean" %>
<jsp:useBean id = "dbBeanId" scope = "session"
 class = "chapter43.DBBean" >
</jsp:useBean>
<%@ page import = "java.sql.*" %>
<html>
 <head>
 <title>BrowseTable</title>
 </head>
 <body>

 <% String tableName = request.getParameter("tablename");

 ResultSet rsColumns = dbBeanId.getConnection().getMetaData().
 getColumns(null, null, tableName, null);

```

```

%>
<table border = "1">
 <tr>
 <% // Add column names to the table
 while (rsColumns.next()) { %>
 <td><%= rsColumns.getString("COLUMN_NAME") %></td>
 <%}%>
 </tr>

 <% Statement statement =
 dBBeanId.getConnection().createStatement();
 ResultSet rs = statement.executeQuery(
 "select * from " + tableName);

 // Get column count
 int columnCount = rs.getMetaData().getColumnCount();

 // Store rows to rowData
 while (rs.next()) {
 out.println("<tr>");
 for (int i = 0; i < columnCount; i++) { %>
 <td><%= rs.getObject(i + 1) %></td>
 <% }
 out.println("</tr>");
 } %>
 </table>
</body>
</html>

```

You start the application from DBLogin.html. This page prompts the user to enter a JDBC driver, URL, username, and password to log in to a database. A list of accessible drivers and URLs is provided in the selection list. You must make sure that these database drivers are added into the Libraries node in the project.

When you click the *Login* button, DBLoginInitialization.jsp is invoked. When this page is processed for the first time, an instance of `DBBean` named `dBBeanId` is created. The input parameters `driver`, `url`, `username`, and `password` are passed to the bean properties. The `initializeJdbc` method loads the driver and establishes a connection to the database. If login fails, the `connection` property is `null`. In this case, an error message is displayed. If login succeeds, control is forwarded to `Table.jsp`.

`Table.jsp` shares `dBBeanId` with `DBLoginInitialization.jsp` in the same session, so it can access `connection` through `dBBeanId` and obtain tables in the database using the database metadata. The table names are displayed in a selection box in a form. When the user selects a table name and clicks the *Browse Table Content* button, `BrowseTable.jsp` is processed.

`BrowseTable.jsp` shares `dBBeanId` with `Table.jsp` and `DBLoginInitialization.jsp` in the same session. It retrieves the table contents for the selected table from `Table.jsp`.

### JSP Scripting Constructs Syntax

- `<%= Java expression %>` The expression is evaluated and inserted into the page.

- **<% Java statement %>** Java statements inserted in the `jspService` method.
- **<%! Java declaration %>** Defines data fields and methods.
- **<%-- JSP comment %>** The JSP comments do not appear in the resultant HTML file.
- **<%@ directive attribute="value" %>** The JSP directives give the JSP engine information about the JSP page. For example, `<%@ page import="java.util.*, java.text.*" %>` imports `java.util.*` and `java.text.*`.
- **<jsp:useBean id="objectName" scope="scopeAttribute" class="ClassName" />** Creates a bean if new. If a bean is already created, associates the id with the bean in the same scope.
- **<jsp:useBean id="objectName" scope="scopeAttribute" class="ClassName" > statements </jsp:useBean>** The statements are executed when the bean is created. If a bean with the same id and class name already exists, the statements are not executed.
- **<jsp:getProperty name="beanId" property="sample" />** Gets the property value from the bean, which is the same as `<%= beanId.getSample() %>`.
- **<jsp:setProperty name="beanId" property="sample" value="test1" />** Sets the property value for the bean, which is the same as `<%= beanId.setSample("test1"); %>`.
- **<jsp:setProperty name="beanId" property="score" param="score" />** Sets the property with an input parameter.
- **<jsp:setProperty name="beanId" property="\*" />** Associates and sets all the bean properties in `beanId` with the input parameters that match the property names.
- **<jsp:forward page="destination" />** Forwards this page to a new page.

### JSP Predefined Variables

- **application** represents the `ServletContext` object for storing persistent data for all clients.
- **config** represents the `ServletConfig` object for the page.
- **out** represents the character output stream, which is an instance of `PrintWriter`, obtained from `response.getWriter()`.
- **page** is alternative to [this](#).
- **request** represents the client's request, which is an instance of `HttpServletRequest` in the servlet's `service` method.
- **response** represents the client's response, which is an instance of `HttpServletResponse` in the servlet's `service` method.
- **session** represents the `HttpSession` object associated with the request, obtained from `request.getSession()`.

### Chapter Summary

1. A JavaServer page is like a regular HTML page with special tags, known as *JSP tags*, which enable the Web server to generate dynamic content. You can create a Web page with static HTML and enclose the code for generating dynamic content in the JSP tags.
2. A JSP page must be stored in a file with a `.jsp` extension. The Web server translates the `.jsp` file into a Java servlet, compiles the servlet, and executes it. The result of the execution is sent to the browser for display.
3. A JSP page is translated into a servlet when the page is requested for the first time. It is not retranslated if the page is not modified. To ensure that the first-time real user does not

encounter a delay, JSP developers should test the page after it is installed.

4. There are three main types of JSP constructs: scripting constructs, directives, and actions. *Scripting* elements enable you to specify Java code that will become part of the resultant servlet. *Directives* enable you to control the overall structure of the resultant servlet. *Actions* enable you to control the behaviors of the JSP engine.
5. Three types of scripting constructs can be used to insert Java code into the resultant servlet: expressions, scriptlets, and declarations.
6. The scope attribute (application, session, page, and request) specifies the scope of a JavaBeans object. Application specifies that the object be bound to the application. Session specifies that the object be bound to the client's session. Page is the default scope, which specifies that the object be bound to the page. Request specifies that the object be bound to the client's request.
7. Web applications developed using JSP generally consist of many pages linked together. JSP provides a forwarding tag in the following syntax that can be used to forward a page to another page: `<jsp:forward page="destination" />`.

### Test Questions

Do the test questions for this chapter online at [www.cs.armstrong.edu/liang/intro9e/test.html](http://www.cs.armstrong.edu/liang/intro9e/test.html).

### Review Questions

#### Sections 43.1-43.3

43.1 What is the file-name extension of a JavaServer page? How is a JSP page processed?

43.2 Can you create a .war that contains JSP in NetBeans? Where should the .war be placed in a Java application server?

43.3 You can display an HTML file (e.g., c:\test.html) by typing the complete file name in the Address field of Internet Explorer. Why can't you display a JSP file by simply typing the file name?

#### Section 43.4

43.4 What are a JSP expression, a JSP scriptlet, and a JSP declaration? How do you write these constructs in JSP?

43.5 Find three syntax errors in the following JSP code:

```
<%! int k %>
<% for (int j = 1; j <= 9; j++) %>
 <%= j; %>

```

43.6 In the following JSP, which variables are instance variables and which are local variables when it is translated into in the servlet?

```
<%! int k; %>
<%! int i; %>
<% for (int j = 1; j <= 9; j++) k += 1;%>
<%= k>
 <%= i>
 <%= getTime()>

<% private long getTime() {
 long time = System.currentTimeMillis();
 return time;
} %>
```

#### Section 43.5

43.7 Describe the predefined variables in JSP.

43.8 What is wrong if the JSP scriptlet `<%` in line 7 in `ComputeLoan.jsp` (Listing 43.3) is replaced by JSP declaration `<%!?`

43.9 Can you use predefined variables (e.g., `request`, `response`, `out`) in JSP declarations?

#### Section 43.6

43.10 Describe the JSP directives and attributes for the `page` directive.

43.11 If a class does not have a package statement, can you import it?

43.12 If you use a custom class from a JSP, where should the class be placed?

#### Section 43.7

43.13 You can create an object in a JSP scriptlet. What is the difference between an object created using the `new` operator and a bean created using the `<jsp:useBean ... >` tag?

43.14 What is the `scope` attribute for? Describe four scope attributes.

43.15 Describe how a `<jsp:useBean ... >` statement is processed by the JSP engine.

#### Sections 43.8-43.10

43.16 How do you associate bean properties with input parameters?

43.17 How do you write a statement to forward requests to another JSP page?

### Programming Exercises

NOTE: Solutions to even-numbered exercises in this chapter are in `exercise\jspexercise` from `evennumberedexercise.zip`, which can be downloaded from the Companion Website.

#### Section 43.4

43.1

(*Factorial table in JSP*) Rewrite Exercise 42.1 using JSP.

43.2

(*Multiplication table in JSP*) Rewrite Exercise 42.2 using JSP.

#### Section 43.5

43.3\*

(*Obtain parameters in JSP*) Rewrite the servlet in Listing 42.4, `GetParameters.java`, using JSP. Create an HTML form that is identical to `StudentRegistrationForm.html` in Listing 42.3 except that the action is replaced by [Exercise40 3.jsp](#) for obtaining parameter values.

#### Section 43.6

43.4

(*Calculate tax in JSP*) Rewrite Exercise 42.4 using JSP. You need to import `ComputeTax` in the JSP.

43.5\*

(*Find scores from text files*) Rewrite Exercise 42.6 using servlets.

43.6\*\*

(*Find scores from database tables*) Rewrite Exercise 42.7 using servlets.

#### Section 43.7

43.7\*\*

(*Change the password*) Rewrite Exercise 42.8 using servlets.

#### Comprehensive

43.8\*

(Store cookies in JSP) Rewrite Exercise 42.10 using JSP. Use `response.addCookie(Cookie)` to add a cookie.

43.9\*

(Retrieve cookies in JSP) Rewrite Exercise 42.11 using JSP. Use `Cookie[] cookies = request.getCookies()` to get all cookies.

43.10

(Draw images) Rewrite Listing 42.13, `ImageContent.java`, using JSP.

43.11\*\*\*

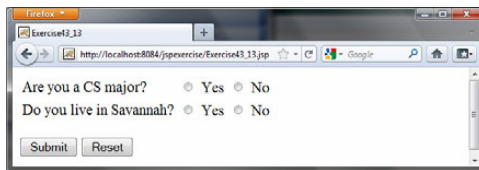
(Syntax highlighting) Rewrite Exercise 42.12 using JSP.

43.12\*\*

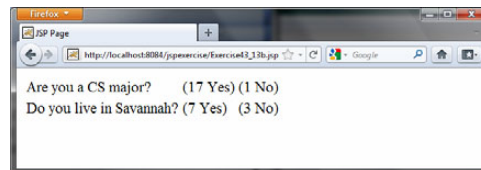
(Opinion poll) Rewrite Exercise 42.13 using JSP.

43.13\*\*\*

(Multiple-question opinion poll) The `Poll` table in Exercise 42.13 contains only one question. Suppose you have a `Poll` table that contains multiple questions. Write a JSP that reads all the questions from the table and display them in a form, as shown in Figure 43.12a. When the user clicks the `Submit` button, another JSP page is invoked. This page updates the Yes or No counts for each question and displays the current Yes and No counts for each question in the `Poll` table, as shown in Figure 43.12b. Note that the table may contain many questions. The questions in the figure are just examples. Sort the questions in alphabetical order.



(a)



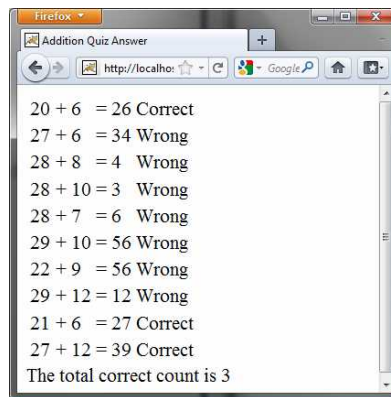
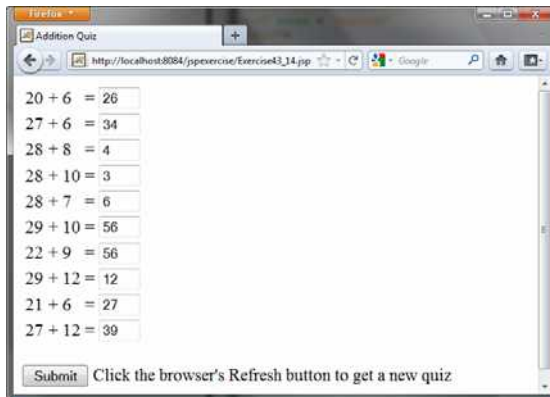
(b)

**Figure 43.12**

The form prompts the user to enter Yes or No for each question in (a), and the updated Yes or No counts are displayed in (b).

43.14\*\*

(Addition quiz) Write a JSP program that generates addition quizzes randomly, as shown in Figure 43.13a. After the user answers all questions, the JSP displays the result, as shown in Figure 43.13b.





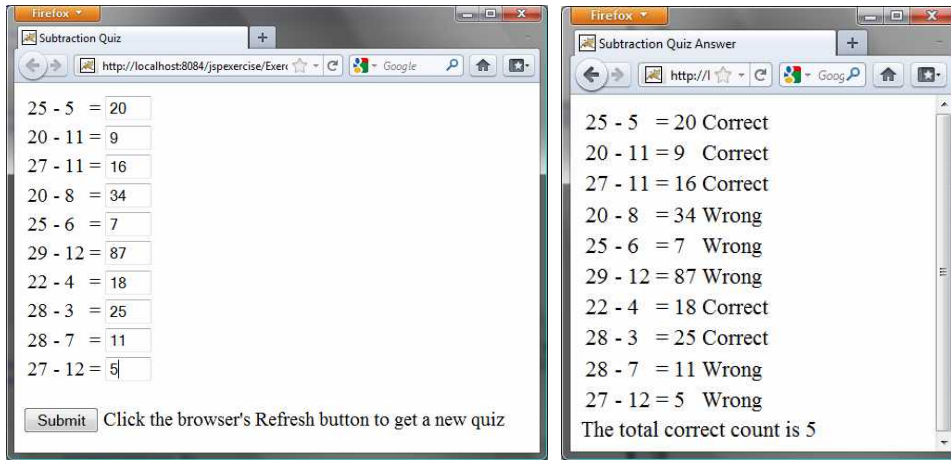
(a)  
**Figure 43.13**

(b)

The program displays addition questions in (a) and answers in (b).

43.15\*\*

(Subtraction quiz) Write a JSP program that generates subtraction quizzes randomly, as shown in Figure 43.14a. The first number must always be greater than or equal to the second number. After the user answers all questions, the JSP displays the result, as shown in Figure 43.14b.



(a)

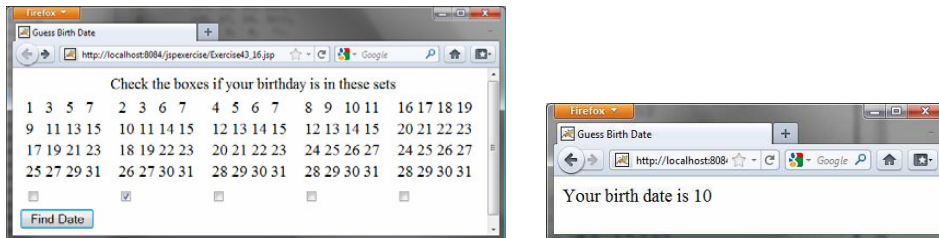
(b)

**Figure 43.14**

The program displays subtraction questions in (a) and answers in (b).

43.16\*\*

(Guess birthday) Listing 3.3, GuessBirthDay.java, gives a program for guessing a birthday. Write a JSP program that displays five sets of numbers, as shown in Figure 43.15a. After the user checks the appropriate boxes and clicks the *Find Date* button, the program displays the date, as shown in Figure 43.15b.



(a)

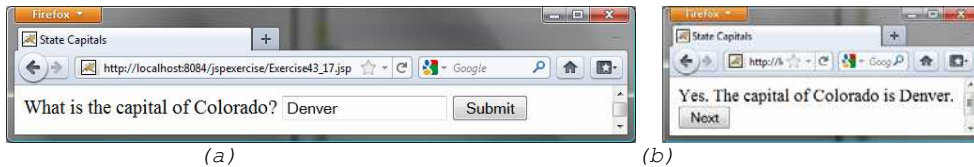
(b)

**Figure 43.15**

(a) The program displays five sets of numbers for the user to check the boxes. (b) The program displays the date.

43.17\*\*

(*Guess capitals*) Write a JSP that prompts the user to enter a capital for a state, as shown in Figure 43.16a. Upon receiving the user input, the program reports whether the answer is correct, as shown in Figure 43.16b. You can click the *Next* button to display another question. You can use a two-dimensional array to store the states and capitals, as proposed in Exercise 9.22. Create a list from the array and apply the `shuffle` method to reorder the list so the questions will appear in random order.



**Figure 43.16**

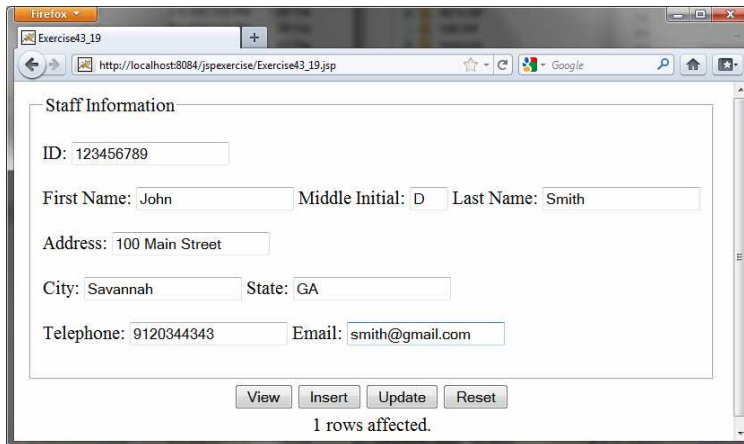
(a) The program displays a question. (b) The program displays the answer to the question.

43.18\*

(*Large factorial*) Rewrite Listing 43.11 to handle large factorial. Use the `BigInteger` class introduced in §14.12.

43.19\*\*

(*Access and update a `Staff` table*) Write a JSP for Exercise 33.1, as shown in Figure 43.17.



**Figure 43.17**

The JSP page lets you view, insert, and update staff information.

43.20\*

(*Guess number*) Write a JSP page that generates a random number between 1 and 1000 and let the user enter a guess. When the user enters a guess, the program should tell the user whether the guess is correct, too high, or too low.

*\*\*\*This is a bonus Web chapter*

## **CHAPTER 44**

### **JavaServer Faces**

#### Objectives

- To explain what JSF is (§44.1).
- To create a JSF page using NetBeans (§44.2).
- To create a JSF managed bean (§44.2).
- To use JSF expressions in a facelet (§44.2).
- To use JSF GUI components (§44.3).
- To obtain and process input from a form (§44.4).
- To track sessions in application, session, view, and request scope (§44.5).
- To validate input using the JSF validators (§44.6).
- To bind database with facelets (§44.7).

## 44.1 Introduction

<margin note: servlets>

<margin note: JSP>

<margin note: JSF>

The use of servlets, introduced in Chapter 42, is the foundation of the Java Web technology. It is a primitive way to write server-side applications. JSP, introduced in Chapter 43, provides a scripting capability and allows you to embed Java code in XHTML. It is easier to develop Web programs using JSP than servlets. However, JSP has some problems. First, it can be very messy, because it mixes Java code with HTML. Second, using JSP to develop user interface is tedious. JavaServer Faces (JSF) comes to rescue. JSF enables you to completely separate Java code from HTML. You can quickly build web applications by assembling reusable UI components in a page, connecting these components to Java programs, and wiring client-generated events to server-side event handlers. The application developed using JSF is easy to debug and maintain.

<margin note: JSF 2>

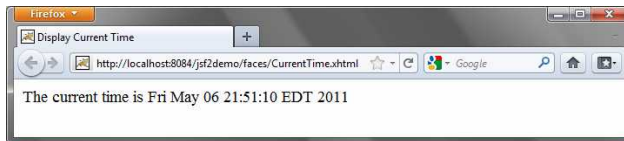
<margin note: XHTML>

<margin note: CSS>

NOTE: This chapter introduces JSF 2, the latest standard for JavaServer Faces. You need to know XHTML (eXtensible HyperText Markup Language) and CSS (Cascading Style Sheet) to start this chapter. For information on XHTML and CSS, see Supplements Part V.A and Part V.B on the companion Website.

## 44.2 Getting Started with JSF

A simple example will illustrate the basics of developing JSF projects using NetBeans. The example is to display the date and time on the server, as shown in Figure 44.1.



**Figure 44.1**

*The application displays the date and time on the server.*

### 44.2.1 Creating a JSF Project

Here are the steps to create the application.

<margin note: create a project>

Choose **File** > **New Project** to display the New Project dialog box. In this box, choose **Java Web** in the Categories pane and **Web Application** in the Projects pane. Click **Next** to display the New Web Application dialog box. In the New Web Application dialog box, enter and select the following fields, as shown in Figure 44.2a:

Project Name: jsf2demo

Project Location: c:\book

Check Set as Main Project

Click *Next* to display the dialog box for choosing servers and settings. Select the following fields as shown in Figure 44.2b. (Note: You can use any server such as GlassFish 3.x that supports Java EE 6.)

Server: Apache Tomcat 7.0.11  
Java EE Version: Java EE 6 Web

Click *Next* to display the dialog box for choosing frameworks, as shown in Figure 44.3. Check *JavaServer Faces* and *JSF 2.0* as Registered Libraries. Click *Finish* to create the project, as shown in Figure 44.4.

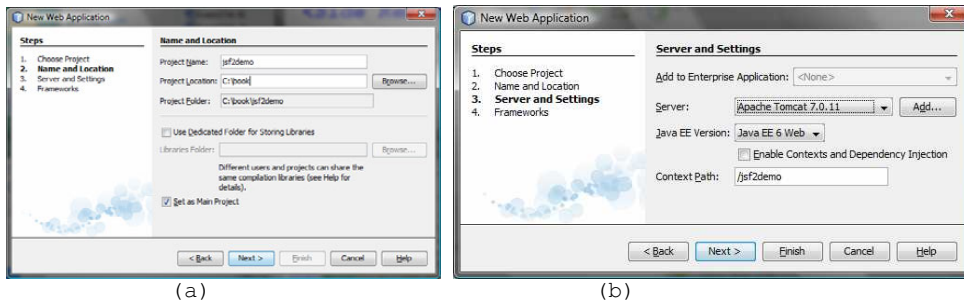


Figure 44.2

The *New Web Application* dialog box enables you to create a new Web project.

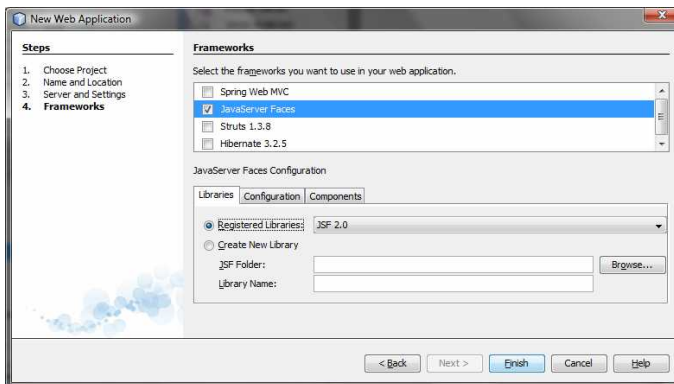
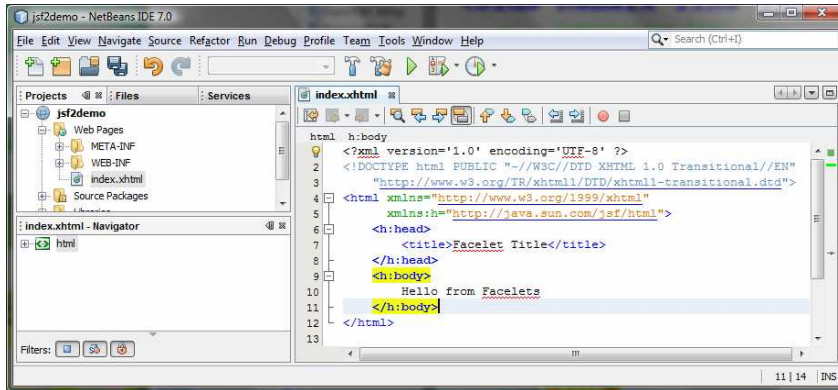


Figure 44.3

Check *JavaServer Faces* and *JSF 2.0* to create the Web project.



**Figure 44.4**

A default JSF page is created in a new Web project.

#### 44.2.2 A Basic JSF Page

##### **<margin note: facelet>**

A new project was just created with a default page named `index.xhtml`, as shown in Figure 44.4. This page is known as a *facelet*, which mixes JSF tags with XHTML tags. Listing 44.1 lists the contents of `index.xhtml`.

Listing 44.1 `index.xhtml`

**\*\*\*PD: Please add line numbers in the following code\*\*\***

**\*\*\*Layout: Please layout exactly. Don't skip the space. This is true for all source code in the book. Thanks, AU.**

**<margin note line 1: xml version>**

**<margin note line 2: comment>**

**<margin note line 3: DOCTYPE>**

**<margin note line 5: default namespace>**

**<margin note line 6: JSF namespace>**

**<margin note line 7: h:head>**

**<margin note line 10: h:body>**

```

1 <?xml version='1.0' encoding='UTF-8' ?>
2 <!-- index.xhtml -->
3 <!DOCTYPE html PUBLIC "-//W3C//DTD XHTML 1.0 Transitional//EN"
4 "http://www.w3.org/TR/xhtml1/DTD/xhtml1-transitional.dtd">
5 <html xmlns="http://www.w3.org/1999/xhtml"
6 xmlns:h="http://java.sun.com/jsf/html">
7 <h:head>
8 <title>Facelet Title</title>
9 </h:head>
10 <h:body>
11 Hello from Facelets
12 </h:body>
13 </html>

```

##### **<margin note: XML declaration>**

Line 1 is an XML declaration to state that the document conforms to the XML version 1.0 and uses the UTF-8 encoding. The declaration is optional, but it is a good practice to use it. Otherwise, a document without the declaration may be assumed of a different version, which may lead to errors. If an XML declaration is present, it must be the first item to appear in the document. This is because an XML processor looks

for the first line to obtain information about the document so that it can be processed correctly.

**<margin note: XML comment>**

Line 2 is a comment for documenting the contents in the file. XML comment always begins with `<!--` and end with `-->`.

**<margin note: DOCTYPE>**

Lines 3-4 specifies the version of XHTML used in the document. This can be used by the Web browser to validate the syntax of the document.

**<margin note: element>**

**<margin note: tag>**

An XML document consists of elements described by tags. An element is enclosed between a start tag and an end tag. XML elements are organized in a tree-like hierarchy. Elements may contain subelements, but there is only one root element in an XML document. All the elements must be enclosed inside the root tag. The root element in XHTML is defined using the `html` tag (line 5).

Each tag in XML must be used in a pair of the start tag and the end tag. A starting begins with `<` followed by the tag name, and ends with `>`. An end tag is the same as its starting except it begins with `</`. The start tag and end tag for `html` are `<html>` and `</html>`.

**<margin note: html tag>**

The `html` element is the root element that contains all other elements in an XHTML page. The starting `<html>` tag (lines 5-6) may contain one or more `xmlns` (XML namespace) attributes to specify the namespace for the elements used in the document. Namespaces are like Java packages. Java packages are used to organize classes and to avoid naming conflict. XHTML namespaces are used to organize tags and resolve naming conflict. If an element with the same name is defined in two namespaces, the fully qualified tag names can be used to differentiate them.

**<margin note: xmlns>**

Each `xmlns` attribute has a name and a value separated by an equal sign (`=`). The following declaration (line 5)

```
xmlns="http://www.w3.org/1999/xhtml"
```

specifies that any unqualified tag names are defined in the default standard `xhtml` namespace.

The following declaration (line 6)

```
xmlns:h="http://java.sun.com/jsf/html"
```

allows the tags defined in the JSF tag library to be used in the document. These tags must have a prefix `h`.

**<margin note: h:head>**

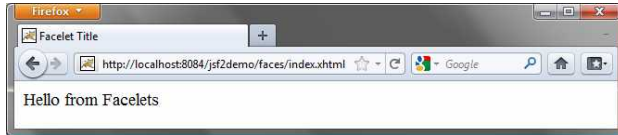
An `html` element contains a head and body. The `h:head` element (lines 7-9) defines an HTML `title` element. The title is usually displayed in the browser window's title bar.

**<margin note: h:body>**

A `h:body` element defines the page's content. In this simple example, it contains a string to be displayed in the Web browser.

NOTE: The XML tag names are case-sensitive, whereas HTML tags are not. So, `<html>` is different from `<HTML>` in XML. Every start tag in XML must have a matching end tag; whereas some tags in HTML does not need end tags.

You can now display the JSP page in `index.xhtml` by right-clicking on `index.xhtml` in the projects pane. The page is displayed in a browser, as shown in Figure 44.5.



**Figure 44.5**

*The `index.xhtml` is displayed in the browser.*

#### 44.2.3 Managed JavaBeans for JSF

JSF applications are developed using the Model-View-Controller (MVC) architecture, which separates the application's data (contained in the model) from the graphical presentation (the view). The controller is the JSF framework that is responsible for coordinating interactions between view and the model.

In JSF, the facelets are the view for presenting data. Data are obtained from Java objects. Objects are defined using Java classes. In JSF, the objects that are accessed from a facelet are JavaBeans objects. If you are not familiar with JavaBeans, please read Chapter 36, "JavaBeans."

Our example in this section is to develop a JSF facelet to display current time. We will create JavaBean with a `getTime()` method that returns the current time as a string. The facelet will invoke this method to obtain current time.

Here are the steps to create a JavaBean named `TimeBean`.

Step 1. Right-click the project node `jsf2demo` to display a context menu as shown in Figure 44.6. Choose *New, JSF Managed Bean* to display the New JSF Managed Bean dialog box, as shown in Figure 44.7. (Note: if you don't see JSF Managed Bean in the menu, choose *Other* to locate JSF Managed Bean.)

Step 2. Enter and select the following fields, as shown in Figure 44.8:

Class Name: `TimeBean`

Package: `jsf2demo`

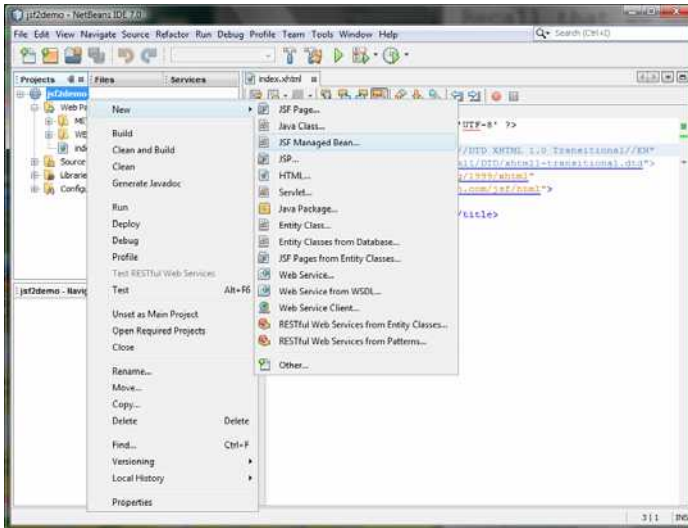
Name: `timeBean`

Scope: `request`

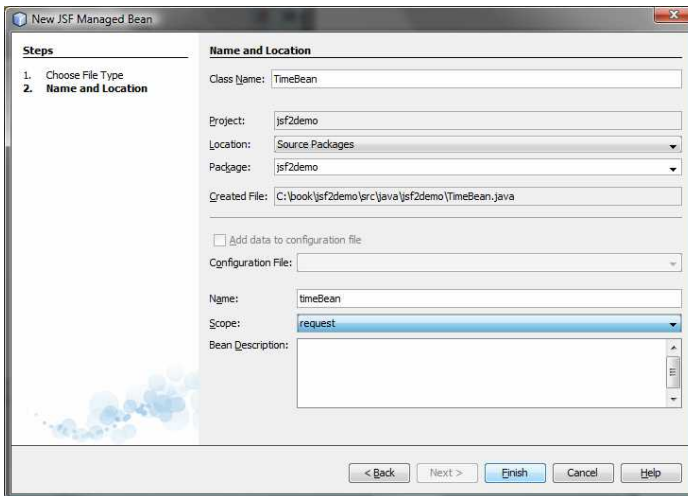
Click *Finish* to create `TimeBean.java`, as shown in Figure 44.9.

Step 3. Add the `getTime()` method to return the current time, as shown in Listing 44.2.

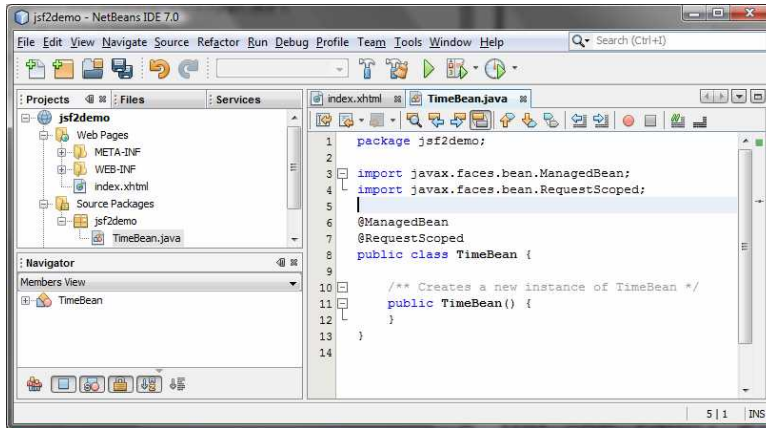




**Figure 44.6**  
*Choose JSF Managed Bean to create a JavaBean for JSF.*



**Figure 44.7**  
*Specify the name, location, scope for the bean.*



**Figure 44.8**  
A JavaBean for JSF was created.

Listing 44.2 TimeBean.java

<margin note line 6: @ManagedBean>  
<margin note line 7: @RequestScoped>  
<margin note line 9: time property>

```

package jsf2demo;

import javax.faces.bean.ManagedBean;
import javax.faces.bean.RequestScoped;

@ManagedBean
@RequestScoped
public class TimeBean {
 public String getTime() {
 return new java.util.Date().toString();
 }
}

```

<margin note: @ManagedBean>

TimeBean is a JavaBeans with the @ManagedBean annotation, which indicates that the JSF framework will create and manage the TimeBean objects used in the application. You have learned to use the @Override annotation in Chapter 15. The @Override annotation tells the compiler that the annotated method is required to override a method in a superclass. The @ManagedBean annotation tells the compiler to generate the code to enable the bean to be used by JSF facelets.

<margin note: @RequestScope>

The @RequestScope annotation specifies the scope of the JavaBeans object is within a request. The JSP scopes were introduced in the preceding chapter. You can also use @SessionScope or @ApplicationScope to specify the scope for a session or for the entire application.

#### 44.2.4 JSF Expressions

Recall that we used JSP scripting to enter Java code in an HTML file to return the current time in the preceding chapter. But JSP scripting will not work with JSF. How can you display the current time from a JSF page?

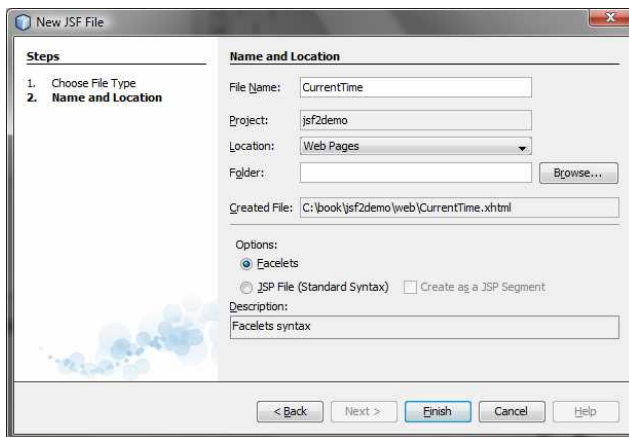
You can display current time by invoking the `getTime()` method in a `TimeBean` object using a JSF expression.

To keep `index.xhtml` intact, we create a new JSF page named `CurrentTime.xhtml` as follows:

Step 1. Right-click the `jsf2demo` node in the project pane to display a context menu and choose `New, JSF Page` to display the New JSF File dialog box, as shown in Figure 44.9.

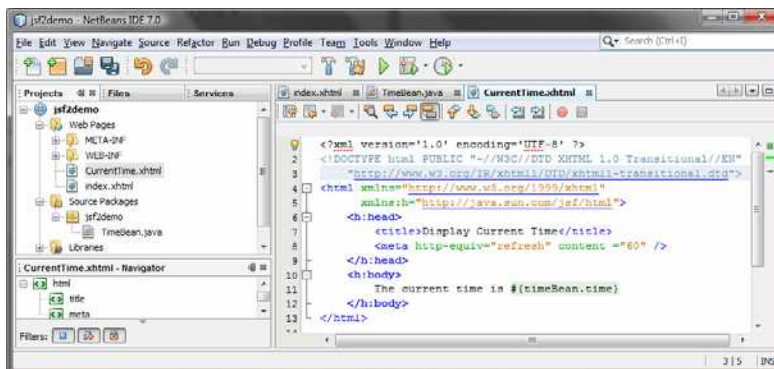
Step 2. Enter `CurrentTime` in the File Name field, choose Facelets and click `Finish` to generate `CurrentTime.xhtml`, as shown in Figure 44.10.

Step 3. Add a JSF expression to obtain the current time, as shown in Listing 44.3.



**Figure 44.9**

*The New JSF File dialog is used to create a JSF page.*



**Figure 44.10**

*A New JSF page CurrentTime was created.*

Listing 44.3 `CurrentTime.xhtml`

*<margin note line 8: refresh page>*  
*<margin note line 11: JSF expression>*

```
<?xml version='1.0' encoding='UTF-8' ?>
```

```

<!DOCTYPE html PUBLIC "-//W3C//DTD XHTML 1.0 Transitional//EN"
 "http://www.w3.org/TR/xhtml1/DTD/xhtml1-transitional.dtd">
<html xmlns="http://www.w3.org/1999/xhtml"
 xmlns:h="http://java.sun.com/jsf/html">
 <h:head>
 <title>Display Current Time</title>
 <meta http-equiv="refresh" content = "60" />
 </h:head>
 <h:body>
 The current time is #{timeBean.time}
 </h:body>
</html>

```

Line 8 defines a `meta` tag inside the `h:head` tag to tell the browser to refresh every 60 seconds. This line can also be written as

```
<meta http-equiv="refresh" content = "60"></ meta>
```

#### **<margin note: empty element>**

An element is called an *empty element* if there are no contents between the start tag and end tag. In an empty element, data is typically specified as attributes in the start tag. You can close an empty element by placing a slash immediately preceding the start tag's right angle bracket, as shown in line 8, for brevity.

Line 8 uses a JSF expression `#{timeBean.time}` to obtain the current time. `timeBean` is an object of the `TimeBean` class. The object name can be changed in the `@ManagedBean` annotation (line 6 in Listing 44.2) using the following syntax:

```
@ManagedBean(name="anyObjectName")
```

By default the object name is the class name with the first letter in lowercase.

Note that `time` is a JavaBeans property, because the `getTime()` method is defined in `TimeBeans`. The JSF expression can either use the property name or invoke the method to obtain the current time. So the following two expressions are both fine.

```
#{timeBean.time}
#{timeBean.getTime() }
```

The syntax of a JSF expression is

```
#{expression}
```

JSF expressions bind JavaBeans objects with facelets. You will see more use of JSF expressions in the upcoming examples in this chapter.

### **44.3 JSF GUI Components**

JSF provides many elements for displaying GUI components. Table 44.1 lists some of the commonly used elements. The tags with the `h` prefix are in the JSF HTML Tag library. The tags with the `f` prefix are in the JSF Core Tag library.

**Table 44.1**

*JSF GUI Form Elements*

JSF Tag	Description
h:form	inserts an XHTML form into a page.
h:panelGroup	similar to a Java flow layout container.
h:panelGrid	similar to a Java grid layout container.
h:inputText	displays a textbox for entering input.
h:outputText	displays a textbox for displaying output.
h:inputTextArea	displays a textarea for entering input.
h:inputSecret	displays a textbox for entering password.
h:outputLabel	displays a label.
h:outputLink	displays a hypertext link.
h:selectOneMenu	displays a combo box for selecting one item.
h:selectOneRadio	displays a set of radio button.
h:selectBooleanCheckbox	displays a checkbox.
h:selectOneListbox	displays a list for selecting one item.
h:selectManyListbox	displays a list for selecting multiple items.
f:selectItem	specifies an item in an h:selectOneMenu, h:selectOneRadio, or h:selectManyListbox.
h:message	displays a message for validating input.
h:dataTable	displays a data table.
h:column	specifies a column in a data table.
h:graphicImage	displays an image.

Listing 44.4 is an example that uses some of these elements to display a student registration form, as shown in Figure 44.11.



**Figure 44.11**

*A student registration form is displayed using JSF elements.*

Listing 44.4 StudentRegistrationForm.xhtml

*<margin note line 6: jsf core namespace>*

<margin note line 14: [graphicImage](#)>  
 <margin note line 18: [h:panelGrid](#)>  
 <margin note line 19: [h:outputLabel](#)>  
 <margin note line 20: [h:inputText](#)>  
 <margin note line 30: [h:selectOneRadio](#)>  
 <margin note line 31: [f:selectItem](#)>  
 <margin note line 41: [h:selectOneMenu](#)>  
 <margin note line 46: [h:selectManyListBox](#)>  
 <margin note line 56: [h:selectManyCheckbox](#)>  
 <margin note line 66: [h:inputTextarea](#)>  
 <margin note line 71: [h:commandButton](#)>

```

<?xml version='1.0' encoding='UTF-8' ?>
<!DOCTYPE html PUBLIC "-//W3C//DTD XHTML 1.0 Transitional//EN"
 "http://www.w3.org/TR/xhtml1/DTD/xhtml1-transitional.dtd">
<html xmlns="http://www.w3.org/1999/xhtml"
 xmlns:h="http://java.sun.com/jsf/html"
 xmlns:f="http://java.sun.com/jsf/core">
 <h:head>
 <title>Student Registration Form</title>
 </h:head>
 <h:body>
 <h:form>
 <!-- Use h:graphicImage -->
 <h3>Student Registration Form
 <h:graphicImage name="usIcon.gif" library="image"/>
 </h3>

 <!-- Use h:panelGrid -->
 <h:panelGrid columns="6" style="color:green">
 <h:outputLabel value="Last Name"/>
 <h:inputText id="lastNameInputText" />
 <h:outputLabel value="First Name" />
 <h:inputText id="firstNameInputText" />
 <h:outputLabel value="MI" />
 <h:inputText id="miInputText" size="1" />
 </h:panelGrid>

 <!-- Use radio buttons -->
 <h:panelGrid columns="2">
 <h:outputLabel>Gender </h:outputLabel>
 <h:selectOneRadio id="genderSelectOneRadio">
 <f:selectItem itemValue="Male"
 itemLabel="Male"/>
 <f:selectItem itemValue="Female"
 itemLabel="Female"/>
 </h:selectOneRadio>
 </h:panelGrid>

 <!-- Use combo box and list -->
 <h:panelGrid columns="4">
 <h:outputLabel value="Major" />
 <h:selectOneMenu id="majorSelectOneMenu">
 <f:selectItem itemValue="Computer Science"/>
 <f:selectItem itemValue="Mathematics"/>
 </h:selectOneMenu>
 <h:outputLabel value="Minor" />
 <h:selectManyListbox id="minorSelectManyListbox">
 <f:selectItem itemValue="Computer Science"/>
 <f:selectItem itemValue="Mathematics"/>
 </h:selectManyListbox>
 </h:panelGrid>
 </h:form>
 </h:body>
</html>

```

```

 <f:selectItem itemValue="English"/>
 </h:selectManyListbox>
</h:panelGrid>

<!-- Use check boxes -->
<h:panelGrid columns="4">
 <h:outputLabel value="Hobby: "/>
 <h:selectManyCheckbox id="hobbySelectManyCheckbox">
 <f:selectItem itemValue="Tennis"/>
 <f:selectItem itemValue="Golf"/>
 <f:selectItem itemValue="Ping Pong"/>
 </h:selectManyCheckbox>
</h:panelGrid>

<!-- Use text area -->
<h:panelGrid columns="1">
 <h:outputLabel>Remarks:</h:outputLabel>
 <h:inputTextarea id="remarksInputTextarea"
 style="width:400px; height:50px;" />
</h:panelGrid>

<!-- Use command button -->
<h:commandButton value="Register" />
</h:form>
</h:body>
</html>

```

**<margin note: jsf core xmlns>**

The tags with prefix `f` are in the JSF core tag library. Line 6

```
xmlns:f="http://java.sun.com/jsf/core">
```

locates the library for these tags.

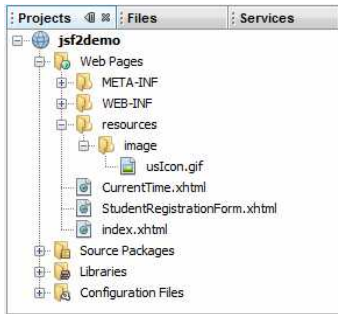
**<margin note: h:graphicImage>**

The `h:graphicImage` tag displays an image in the file `usIcon.gif` (line 14). The file is located in the `/resources/image` folder. In JSF 2.0, all resources (image files, audio files, CCS files) should be placed under the `resources` folder under the **Web Pages** node. You can create these folders as follows:

Step 1: Right-click the Web Pages node in the project pane to display a context menu and choose *New, Folder* to display the New Folder dialog box. (If Folder is not in the context menu, choose *Other* to locate it.)

Step 2: Enter `resources` as the Folder Name and click *Finish* to create the `resources` folder, as shown in Figure 44.12.

Step 3: Right-click the `resources` node in the project pane to create the image folder under `resources`. You can now place `usImage.gif` under the image folder.



**Figure 44.12**  
*The resources folder was created.*

**<margin note: [h:panelGrid](#)>**

JSF provides [h:panelGrid](#) and [h:panelGroup](#) elements to contain and layout subelements. [h:panelGrid](#) places the elements in a grid like the Java grid layout manager. [h:panelGroup](#) places the elements like a Java GUI flow layout manager. Lines 18-25 places six elements (labels and input texts) are in a [h:panelGrid](#). The [columns](#) attribute specifies that each row in the grid has 6 columns. The elements are placed into a row from left to right in the order they appear in the facelet. When a row is full, a new row is created to hold the elements. We used [h:panelGrid](#) in this example. You may replace it with [h:panelGroup](#) to see how the elements would be arranged.

**<margin note: the [style](#) attribute>**

You may use the [style](#) attribute with a JSF html tag to specify the CSS style for the element and its subelements. The [style](#) attribute in line 8 specifies color green for all elements in this [h:panelGrid](#) element.

**<margin note: [h:outputLabel](#)>**

The [h:outputLabel](#) element is for displaying a label (line 19). You can use the [value](#) attribute to specify the label's text.

**<margin note: [h:inputText](#)>**

The [h:inputText](#) element is for displaying a text input box for the user to enter a text (line 20). The [id](#) attribute is useful for other elements or the server program to reference this element.

**<margin note: [h:selectOneRadio](#)>**

The [h:selectOneRadio](#) element is for displaying a group of radio buttons (line 30). Each radio button is defined using an [f:selectItem](#) element (lines 31-34).

**<margin note: [h:selectOneMenu](#)>**

The [h:selectOneMenu](#) element is for displaying a combo box (line 41). Each item in the combo box is defined using an [f:selectItem](#) element (lines 42-43).

**<margin note: [h:selectManyListbox](#)>**

The [h:selectManyListbox](#) element is for displaying a list for the user to choose multiple items in a list (line 46). Each item in the list is defined using an [f:selectItem](#) element (lines 47-49).

**<margin note: [h:selectManyCheckbox](#)>**



The `h:selectManyCheckbox` element is for displaying a group of check boxes (line 56). Each item in the check box is defined using an `f:selectItem` element (lines 57-59).

**<margin note: `h:selectTextarea`>**

The `h:selectTextarea` element is for displaying a text area for multiple lines of input (line 66). You can use the `style` attribute to specify the width and height of the text area (line 67).

**<margin note: `h:selectTextarea`>**

The `h:selectTextarea` element is for displaying a text area for multiple lines of input (line 66). The `style` attribute is used to specify the width and height of the text area (line 67).

**<margin note: `h:commandButton`>**

The `h:commandButton` element is for displaying a button. When the button is clicked, an action is performed. The default action is to request the same page from the server. The next section shows how to process the form.

#### 44.4 Processing the Form

The preceding section introduced how to display a form using common JSF elements. This section shows how to obtain and process the input.

To obtain input from the form, simply bind each input element with a property in a managed bean. We now define a managed bean named `Registration` as shown in Listing 44.5.

Listing 44.5 `Registration.java`

**<margin note line 6: managed bean>**  
**<margin note line 7: request scope>**  
**<margin note line 9: property `lastName`>**  
**<margin note line 82: `getResponse()`>**

```
package jsf2demo;

import javax.faces.bean.ManagedBean;
import javax.faces.bean.RequestScoped;

@ManagedBean
@RequestScoped
public class Registration {
 private String lastName;
 private String firstName;
 private String mi;
 private String gender;
 private String major;
 private String[] minor;
 private String[] hobby;
 private String remarks;

 public String getLastName() {
 return lastName;
 }

 public void setLastName(String lastName) {
 this.lastName = lastName;
 }
}
```

```

public String getFirstName() {
 return firstName;
}

public void setFirstName(String firstName) {
 this.firstName = firstName;
}

public String getMi() {
 return mi;
}

public void setMi(String mi) {
 this.mi = mi;
}

public String getGender() {
 return gender;
}

public void setGender(String gender) {
 this.gender = gender;
}

public String getMajor() {
 return major;
}

public void setMajor(String major) {
 this.major = major;
}

public String[] getMinor() {
 return minor;
}

public void setMinor(String[] minor) {
 this.minor = minor;
}

public String[] getHobby() {
 return hobby;
}

public void setHobby(String[] hobby) {
 this.hobby = hobby;
}

public String getRemarks() {
 return remarks;
}

public void setRemarks(String remarks) {
 this.remarks = remarks;
}

public String getResponse() {
 if (lastName == null)
 return ""; // Request has not been made
 else {
 String allMinor = "";

```

```

 for (String s: minor) {
 allMinor += s + " ";
 }

 String allHobby = "";
 for (String s: hobby) {
 allHobby += s + " ";
 }

 return "<p style=\"color:red\">You entered
" +
 "Last Name: " + lastName + "
" +
 "First Name: " + firstName + "
" +
 "MI: " + mi + "
" +
 "Gender: " + gender + "
" +
 "Major: " + major + "
" +
 "Minor: " + allMinor + "
" +
 "Hobby: " + allHobby + "
" +
 "Remarks: " + remarks + "</p>";
 }
}
}

```

**<margin note: bean properties>**

The Registration class is a managed bean that defines the properties `lastName`, `firstName`, `mi`, `gender`, `major`, `minor`, and `remarks`, which will be bound to the elements in the JSF registration form.

The registration form can now be redefined as shown in Listing 44.6. Figure 44.13 shows that new JSF page displays the user input upon clicking the Register button.

Listing 44.6 ProcessStudentRegistrationForm.xhtml

**<margin note line 6: jsf core namespace>**  
**<margin note line 21: bind `lastName`>**  
**<margin note line 24: bind `firstName`>**  
**<margin note line 27: bind `mi`>**  
**<margin note line 34: bind `gender`>**  
**<margin note line 46: bind `major`>**  
**<margin note line 52: bind `minor`>**  
**<margin note line 63: bind `hobby`>**  
**<margin note line 75: bind `remarks`>**  
**<margin note line 82: bind `response`>**

```

<?xml version='1.0' encoding='UTF-8' ?>
<!DOCTYPE html PUBLIC "-//W3C//DTD XHTML 1.0 Transitional//EN"
 "http://www.w3.org/TR/xhtml1/DTD/xhtml1-transitional.dtd">
<html xmlns="http://www.w3.org/1999/xhtml"
 xmlns:h="http://java.sun.com/jsf/html"
 xmlns:f="http://java.sun.com/jsf/core">
 <h:head>
 <title>Student Registration Form</title>
 </h:head>
 <h:body>
 <h:form>
 <!-- Use h:graphicImage -->
 <h3>Student Registration Form
 <h:graphicImage name="usIcon.gif" library="image"/>
 </h3>

```

```

<!-- Use h:panelGrid -->
<h:panelGrid columns="6" style="color:green">
 <h:outputLabel value="Last Name"/>
 <h:inputText id="lastNameInputText"
 value="#{registration.lastName}"/>
 <h:outputLabel value="First Name" />
 <h:inputText id="firstNameInputText"
 value="#{registration.firstName}"/>
 <h:outputLabel value="MI" />
 <h:inputText id="miInputText" size="1"
 value="#{registration.mi}"/>
</h:panelGrid>

<!-- Use radio buttons -->
<h:panelGrid columns="2">
 <h:outputLabel>Gender </h:outputLabel>
 <h:selectOneRadio id="genderSelectOneRadio"
 value="#{registration.gender}">
 <f:selectItem itemValue="Male"
 itemLabel="Male"/>
 <f:selectItem itemValue="Female"
 itemLabel="Female"/>
 </h:selectOneRadio>
</h:panelGrid>

<!-- Use combo box and list -->
<h:panelGrid columns="4">
 <h:outputLabel value="Major" />
 <h:selectOneMenu id="majorSelectOneMenu"
 value="#{registration.major}">
 <f:selectItem itemValue="Computer Science"/>
 <f:selectItem itemValue="Mathematics"/>
 </h:selectOneMenu>
 <h:outputLabel value="Minor" />
 <h:selectManyListbox id="minorSelectManyListbox"
 value="#{registration.minor}">
 <f:selectItem itemValue="Computer Science"/>
 <f:selectItem itemValue="Mathematics"/>
 <f:selectItem itemValue="English"/>
 </h:selectManyListbox>
</h:panelGrid>

<!-- Use check boxes -->
<h:panelGrid columns="4">
 <h:outputLabel value="Hobby: " />
 <h:selectManyCheckbox id="hobbySelectManyCheckbox"
 value="#{registration.hobby}">
 <f:selectItem itemValue="Tennis"/>
 <f:selectItem itemValue="Golf"/>
 <f:selectItem itemValue="Ping Pong"/>
 </h:selectManyCheckbox>
</h:panelGrid>

<!-- Use text area -->
<h:panelGrid columns="1">
 <h:outputLabel>Remarks:</h:outputLabel>
 <h:inputTextarea id="remarksInputTextarea"
 style="width:400px; height:50px;"
 value="#{registration.remarks}"/>
</h:panelGrid>

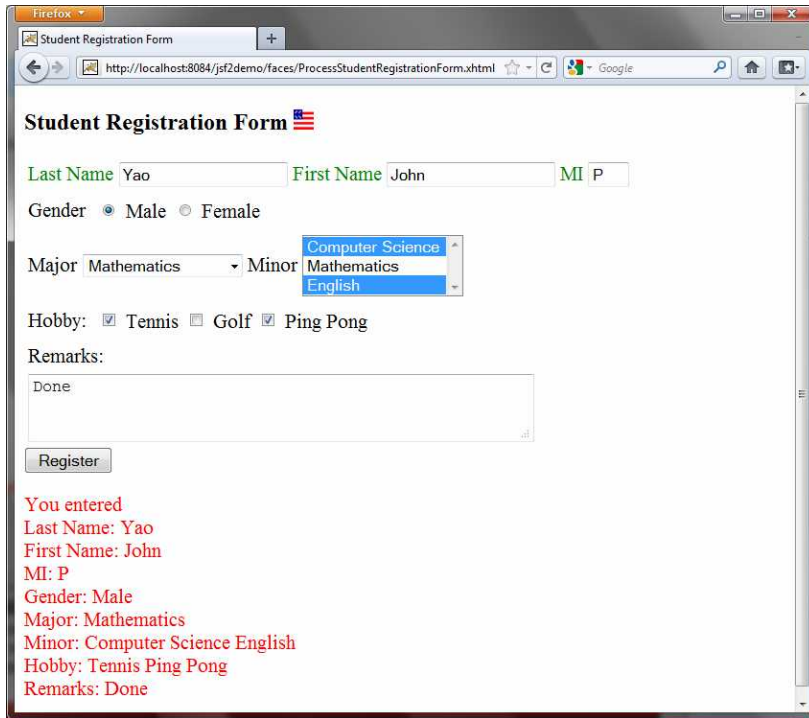
```

```

<!-- Use command button -->
<h:commandButton value="Register" />

<h:outputText escape="false" style="color:red"
value="#{registration.response}" />
</h:form>
</h:body>
</html>

```



**Figure 44.13**

*The user input is collected and displayed after clicking the Register button.*

**<margin note: binding input texts>**

The new JSF form in this listing binds the `h:inputText` element for last name, first name, and mi with the properties `lastName`, `firstName`, and `mi` in the managed bean (lines 22, 24, 27). When the `Register` button is clicked, the page is sent to the server, which invokes the set methods to set the properties in the managed bean.

**<margin note: binding radio buttons>**

The `h:selectOneRadio` element is bound to the `gender` property (line 34). Each radio button has an `itemValue`. The selected radio button's `itemValue` is set to the `gender` property in the bean when the page is sent to the server.

**<margin note: binding combo box>**

The `h:selectOneMenu` element is bound to the `major` property (line 46). When the page is sent to the server, the selected item is returned as a string and is set to the `major` property.

**<margin note: binding list box>**

The `h:selectManyListbox` element is bound to the `minor` property (line 52). When the page is sent to the server, the selected items are returned as an array of strings and set to the `minor` property.

**<margin note: binding check boxes>**

The `h:selectManyCheckbox` element is bound to the `hobby` property (line 63). When the page is sent to the server, the checked boxes are returned as an array of `itemValues` and set to the `hobby` property.

**<margin note: binding text area>**

The `h:selectTextarea` element is bound to the `remarks` property (line 75). When the page is sent to the server, the content in the text area is returned as a string and set to the `remarks` property.

**<margin note: binding response>**

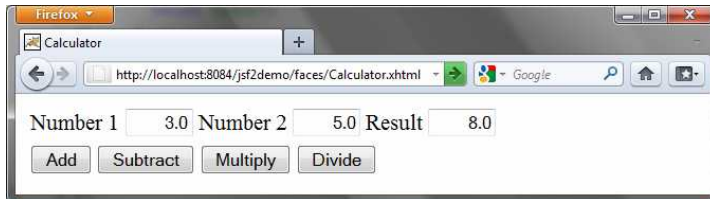
The `h:outputText` element is bound to the `response` property (line 82). This is a read-only property in the bean. It is "" if `lastName` is null (lines 83-84 in Listing 44.5). When the page is returned to the client, the response property value is displayed in the output text element (line 82).

**<margin note: escape attribute>**

The `h:outputText` element's `escape` attribute is set to `false` (line 81) to enable the contents to be displayed in HTML. By default, the `escape` attribute is `true`, which indicates the contents are considered as regular text.

#### 44.5 Case Study: Calculator

This section uses JSF to develop a calculator to perform addition, subtraction, multiplication, and division, as shown in Figure 44.21.



**Figure 44.21**

*This JSF application enables you to perform addition, subtraction, multiplication, and division.*

Here are the steps to develop this project:

**<margin note: create managed bean>**

Step 1. Create a new managed bean named `Calculator` with the request scope as shown in Listing 44.7, `Calculator.java`.

**<margin note: create JSF facelet>**

Step 2. Create a JSP facelet named `Calculator` as shown in Listing 44.8, `Calculator.xhtml`.

Listing 44.7 `Calculator.java`

**<margin note line 9: property number1>**

<margin note line 10: property number2>  
<margin note line 11: property result>  
<margin note line 40: add>  
<margin note line 44: subtract>  
<margin note line 48: divide>  
<margin note line 52: multiply>

```
package jsf2demo;

import javax.faces.bean.ManagedBean;
import javax.faces.bean.RequestScoped;

@ManagedBean
@RequestScoped
public class Calculator {
 private Double number1;
 private Double number2;
 private Double result;

 public Calculator() {
 }

 public Double getNumber1() {
 return number1;
 }

 public Double getNumber2() {
 return number2;
 }

 public Double getResult() {
 return result;
 }

 public void setNumber1(Double number1) {
 this.number1 = number1;
 }

 public void setNumber2(Double number2) {
 this.number2 = number2;
 }

 public void setResult(Double result) {
 this.result = result;
 }

 public void add() {
 result = number1 + number2;
 }

 public void subtract() {
 result = number1 - number2;
 }

 public void divide() {
 result = number1 / number2;
 }

 public void multiply() {
 result = number1 * number2;
 }
}
```

```
}
}
```

The managed bean has three properties `number1`, `number2`, and `result` (lines 9-38). The methods `add()`, `subtract()`, `divide()`, and `multiply()` add, subtract, multiply, and divide `number1` with `number2` and assigns the result to `result` (lines 40-54).

Listing 44.8 Calculator.xhtml

*<margin note line 14: right align>*  
*<margin note line 15: bind text input>*  
*<margin note line 28: action>*

```
<?xml version='1.0' encoding='UTF-8' ?>
<!DOCTYPE html PUBLIC "-//W3C//DTD XHTML 1.0 Transitional//EN"
 "http://www.w3.org/TR/xhtml1/DTD/xhtml1-transitional.dtd">
<html xmlns="http://www.w3.org/1999/xhtml"
 xmlns:h="http://java.sun.com/jsf/html">
 <h:head>
 <title>Calculator</title>
 </h:head>
 <h:body>
 <h:form>
 <h:panelGrid columns="6">
 <h:outputLabel value="Number 1"/>
 <h:inputText id="number1InputText" size="4"
 style="text-align: right"
 value="#{calculator.number1}"/>
 <h:outputLabel value="Number 2" />
 <h:inputText id="number2InputText" size="4"
 style="text-align: right"
 value="#{calculator.number2}"/>
 <h:outputLabel value="Result" />
 <h:inputText id="resultInputText" size="4"
 style="text-align: right"
 value="#{calculator.result}"/>
 </h:panelGrid>

 <h:panelGrid columns="4">
 <h:commandButton value="Add"
 action="#{calculator.add}"/>
 <h:commandButton value="Subtract"
 action="#{calculator.subtract}"/>
 <h:commandButton value="Multiply"
 action="#{calculator.multiply}"/>
 <h:commandButton value="Divide"
 action="#{calculator.divide}"/>
 </h:panelGrid>
 </h:form>
 </h:body>
</html>
```

Three text input components along with their labels are placed in the grid panel (lines 11-24). Four button components are placed in the grid panel (lines 26-35).

The bean property `number1` is bound to the text input for Number 1 (line 15). The CSS style `text-align: right` (line 14) specifies that the text is right-aligned in the input box.

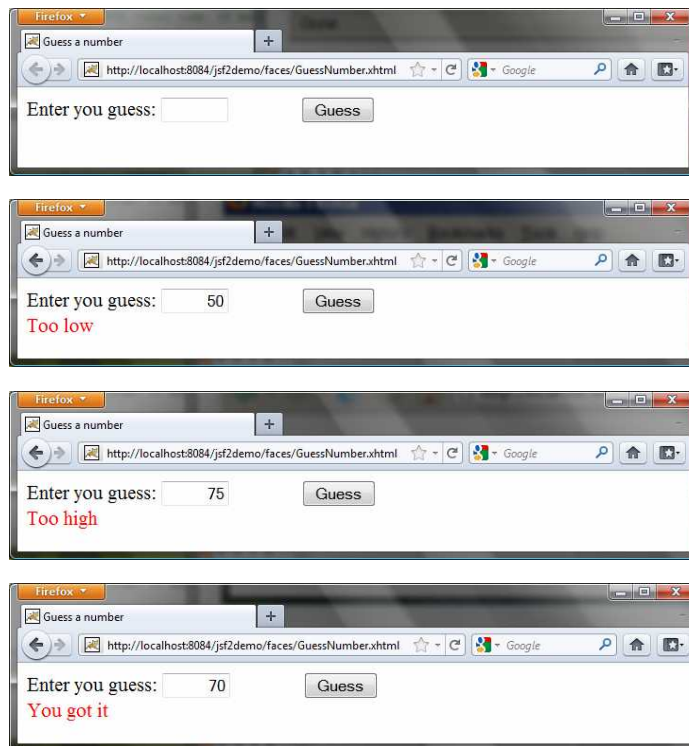


The `action` attribute for the `Add` button is set to the `add` method in the calculator bean (line 28). When the `Add` button is clicked, the `add` method in the bean is invoked to add `number1` with `number2` and assign the result to `result`. Since the `result` property is bound to the Result input text, the new result is now displayed in the text input field.

#### 44.6 Session Tracking

Chapter 43, "JSP," introduced session tracking using JavaBeans by sharing the JavaBeans objects among different pages. You can specify the JavaBeans objects at the application scope, session scope, page scope, or request scope. JSF supports session tracking using JavaBeans at the application scope, session scope, and request scope. Additionally, JSF 2.0 supports the view `scope`, which keeps the bean alive as long as you stay on the view. The view scope is between session and request scopes.

Consider the following example that prompts the user to guess a number. When the page starts, the program randomly generates a number between 0 and 99. This number is stored in the session. When the user enters a guess, the program checks the guess with the random number in the session and tells the user whether the guess is too high, too low, or just right, as shown in Figure 44.14.



**Figure 44.14**

*The user enters a guess and the program displays the result.*

Here are the steps to develop this project:

**<margin note: create managed bean>**

Step 1. Create a new managed bean named `GuessNumber` with the view scope as shown in Listing 44.9, `GuessNumber.java`.

*<margin note: create JSF facelet>*

Step 2. Create a JSP facelet named `GuessNumber` as shown in Listing 44.10, `GuessNumber.xhtml`.

Listing 44.9 `GuessNumber.java`

*<margin note line 7: view scope>*

*<margin note line 9: random number>*

*<margin note line 10: guess by user>*

*<margin note line 13: create random number>*

*<margin note line 16: get method>*

*<margin note line 20: set method>*

*<margin note line 24: get response>*

*<margin note line 28: check guess>*

```
package jsf2demo;

import javax.faces.bean.ManagedBean;
import javax.faces.bean.ViewScoped;

@ManagedBean
@ViewScoped
public class GuessNumber {
 private int number;
 private String guessString;

 public GuessNumber() {
 number = (int)(Math.random() * 100);
 }

 public String getGuessString() {
 return guessString;
 }

 public void setGuessString(String guessString) {
 this.guessString = guessString;
 }

 public String getResponse() {
 if (guessString == null)
 return ""; // No user input yet

 int guess = Integer.parseInt(guessString);
 if (guess < number)
 return "Too low";
 else if (guess == number)
 return "You got it";
 else
 return "Too high";
 }
}
```

The managed bean uses the `@ViewScope` annotation (line 5) to set up the view scope for the bean. The view scope is most appropriate for this project. The bean is alive as long as the view is not changed. The bean is created when the page is displayed for the first time. A random number between 0 and 99 is assigned to `number` (line 13) when the bean is created. This number will not change as long as the bean is alive.

The `getResponse` method converts `guessString` from the user input to an integer (line 28) and determines if the guess is too low (line 30), too high (line 34), and just right (line 32).

Listing 44.10 `GuessNumber.xhtml`

**<margin note line 14: bind text input>**

**<margin note line 18: bind text output>**

```
<?xml version='1.0' encoding='UTF-8' ?>
<!DOCTYPE html PUBLIC "-//W3C//DTD XHTML 1.0 Transitional//EN"
 "http://www.w3.org/TR/xhtml1/DTD/xhtml1-transitional.dtd">
<html xmlns="http://www.w3.org/1999/xhtml"
 xmlns:h="http://java.sun.com/jsf/html">
 <h:head>
 <title>Guess a number</title>
 </h:head>
 <h:body>
 <h:form>
 <h:outputLabel value="Enter you guess: "/>
 <h:inputText style="text-align: right; width: 50px"
 id="guessInputText"
 value="#{guessNumber.guessString}"/>
 <h:commandButton style="margin-left: 60px" value="Guess" />

 <h:outputText style="color: red"
 value="#{guessNumber.response}" />
 </h:form>
 </h:body>
</html>
```

The bean property `guessString` is bound to the text input (line 14). The CSS style `text-align: right` (line 13) specifies that the text is right-aligned in the input box.

The CSS style `margin-left: 60px` (line 15) specifies that the command button has a left margin of 60 pixels.

The bean property `response` is bound to the text output (line 18). The CSS style `color: red` (line 17) specifies that the text is displayed in red in the output box.

**<margin note: scope>**

The project uses the **view** scope. What happens if the scope is changed to the request scope? Every time the page is refreshed, JSF creates a new bean with a new random number. What happens if the scope is changed to the **session** scope? The bean will be alive as long as the browser is alive. What happens if the scope is changed to the **application** scope? The bean will be created once when the application is launched from the server.

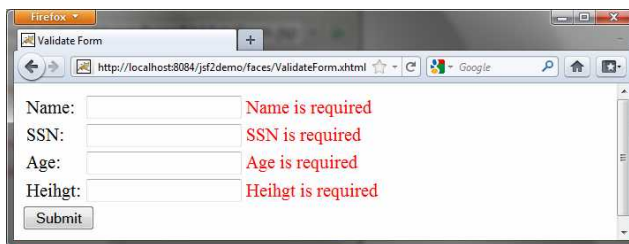
#### 44.7 Validating Input

In the preceding `GuessNumber` page, an error would occur if you entered a non-integer in the input box before clicking the `Guess` button. A simple way to fix the problem is to check the text field before processing any event. JSF provides several convenient and powerful ways for input validation. You can use the standard validator tags in the JSF Core Tag Library or create custom validators. Table 44.2 lists some JSF input validator tags.

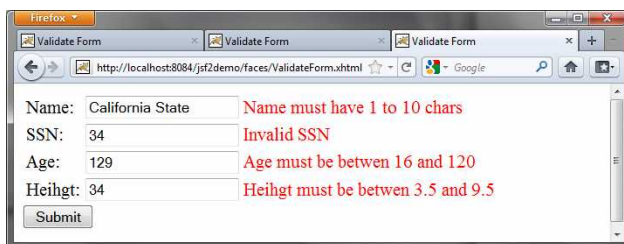
**Table 44.2***JSF Input Validator Tags*

<b>JSF Tag</b>	<b>Description</b>
<code>f:validateLength</code>	validates the length of the input.
<code>f:validateDoubleRange</code>	validates whether numeric input falls within acceptable range of double values.
<code>f:validateLongRange</code>	validates whether numeric input falls within acceptable range of long values.
<code>f:validateRequired</code>	validates whether a field is not empty.
<code>f:validateRegex</code>	validates whether the input matches a regular expression.
<code>f:validateBean</code>	invokes a custom method in a bean to perform custom validation.

Consider the following example that displays a form for collecting user input as shown in Figure 44.15. All text fields in the form must be filled. If not, error messages are displayed. The SSN must be formatted corrected. If not, an error is displayed. If all input is correct, clicking *Submit* displays the result in an output text, as shown in Figure 44.16.



(a) The required messages are displayed if input is required, but empty.



(b) Error messages are displayed if input is incorrect.

**Figure 44.15**

The input fields are validated.



**Figure 44.16**

*The correct input values are displayed.*

Here are the steps to create this project.

Step 1. Create a new page named `ValidateForm`, as shown in Listing 44.11.

Step 2. Create a new managed bean named `ValidateForm`, as shown in Listing 44.12.

Listing 44.11 `ValidateForm.xhtml`

```

<margin note line 14: required input>
<margin note line 15: required message>
<margin note line 16: validator message>
<margin note line 18: validate length>
<margin note line 20: message element>
<margin note line 27: validate regex>
<margin note line 36: validate integer range>
<margin note line 45: validate double range>

<?xml version='1.0' encoding='UTF-8' ?>
<!DOCTYPE html PUBLIC "-//W3C//DTD XHTML 1.0 Transitional//EN"
 "http://www.w3.org/TR/xhtml1/DTD/xhtml1-transitional.dtd">
<html xmlns="http://www.w3.org/1999/xhtml"
 xmlns:h="http://java.sun.com/jsf/html"
 xmlns:f="http://java.sun.com/jsf/core">
 <h:head>
 <title>Validate Form</title>
 </h:head>
 <h:body>
 <h:form>
 <h:panelGrid columns="3">
 <h:outputLabel value="Name:" />
 <h:inputText id="nameInputText" required="true"
 requiredMessage="Name is required"
 validatorMessage="Name must have 1 to 10 chars"
 value="#{validateForm.name}">
 <f:validateLength minimum="1" maximum="10" />
 </h:inputText>
 <h:message for="nameInputText" style="color:red"/>

 <h:outputLabel value="SSN:" />
 <h:inputText id="ssnInputText" required="true"
 requiredMessage="SSN is required"
 validatorMessage="Invalid SSN"
 value="#{validateForm.ssn}">
 <f:validateRegex pattern="\d{3}-[\d]{2}-[\d]{4}" />
 </h:inputText>
 <h:message for="ssnInputText" style="color:red"/>
 </h:panelGrid>
 </h:form>
 </h:body>
</html>

```

```

<h:outputLabel value="Age:" />
<h:inputText id="ageInputText" required="true"
 requiredMessage="Age is required"
 validatorMessage="Age must be between 16 and 120"
 value="#{validateForm.ageString}">
 <f:validateLongRange minimum="16" maximum="120"/>
</h:inputText>
<h:message for="ageInputText" style="color:red"/>

<h:outputLabel value="Heihgt:" />
<h:inputText id="heightInputText" required="true"
 requiredMessage="Heihgt is required"
 validatorMessage="Heihgt must be betwen 3.5 and 9.5"
 value="#{validateForm.heightString}">
 <f:validateDoubleRange minimum="3.5" maximum="9.5"/>
</h:inputText>
<h:message for="heightInputText" style="color:red"/>
</h:panelGrid>

<h:commandButton value="Submit" />

<h:outputText style="color:red"
 value="#{validateForm.response}" />
</h:form>
</h:body>
</html>

```

**<margin note: required attribute>**

**<margin note: requiredMessage>**

For each input text field, set its required attribute true (line 14) to indicate that an input value is required for the field. When a required input field is empty, the requiredMessage is displayed (line 15).

**<margin note: validatorMessage>**

**<margin note: f:validateLength>**

The validatorMessage attribute specifies a message to be displayed if the input field is invalid (line 16). The f:validateLength tag specifies the minimum or maximum length of the input (line 18). JSF will determine whether the input length is valid.

**<margin note: h:message>**

The h:message element displays the validatorMessage if the input is invalid. The element's for attribute specifies the id of the element for which the message will be displayed (line 20).

**<margin note: f:validateRegex>**

The f:validateRegex tag specifies a regular expression for validating the input (line 27). For information on regular expression, see Supplement III.H.

**<margin note: f:validateLongRange>**

The f:validateLongRange tag specifies a range for an integer input using the minimum and maximum attribute (line 36). In this project, a valid age value is between 16 and 120.

**<margin note: f:validateDoubleRange>**

The f:validateDoubleRange tag specifies a range for a double input using the minimum and maximum attribute (line 36). In this project, a valid height value is between 3.5 and 9.5.

Listing 44.12 ValidateForm.java

*<margin note line 49: some input not set>*

```
package jsf2demo;

import javax.faces.bean.ManagedBean;
import javax.faces.bean.RequestScoped;

@ManagedBean
@RequestScoped
public class ValidateForm {
 private String name;
 private String ssn;
 private String ageString;
 private String heightString;

 public String getName() {
 return name;
 }

 public void setName(String name) {
 this.name = name;
 }

 public String getSsn() {
 return ssn;
 }

 public void setSsn(String ssn) {
 this.ssn = ssn;
 }

 public String getAgeString() {
 return ageString;
 }

 public void setAgeString(String ageString) {
 this.ageString = ageString;
 }

 public String getHeightString() {
 return heightString;
 }

 public void setHeightString(String heightString) {
 this.heightString = heightString;
 }

 public String getResponse() {
 if (name == null || ssn == null || ageString == null
 || heightString == null) {
 return "";
 }
 else {
 return "You entered " +
 " Name: " + name +
 " SSN: " + ssn +
 " Age: " + ageString +
 " Heihgt: " + heightString;
 }
 }
}
```

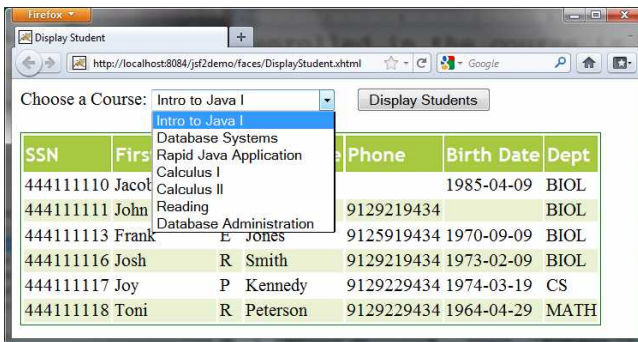
}  
}

If an input is invalid, its value is not set to the bean. So only when all input are correct, the `getResponse()` method will return all input values (lines 46-58)

#### 41.8 Binding Database with Facelets

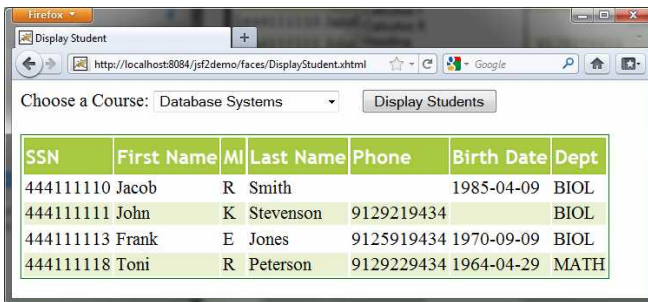
Often you need to access database from a Web page. This section gives examples of building Web applications using databases.

Consider the following example that lets the user choose a course, as shown in Figure 44.17. After a course is selected in the drop down list, the students enrolled in the course are displayed in the table, as shown in Figure 41.18. In this example, all the course titles in the `Course` table are bound to the combo box and the query result for the students enrolled in the course is bound to the table.



**Figure 44.17**

*You need to choose a course and display the students enrolled in the course.*



**Figure 44.18**

*The table displays the students enrolled in the course.*

Here are the steps to create this project:

**<margin note: Managed bean>**

Step 1. Create a managed bean named `CourseName` with application scope, as shown in Listing 44.13.

**<margin note: JSF page>**

Step 2. Create a JSP page named `DisplayStudent`, as shown in Listing 44.14.



**<margin note: style sheet>**

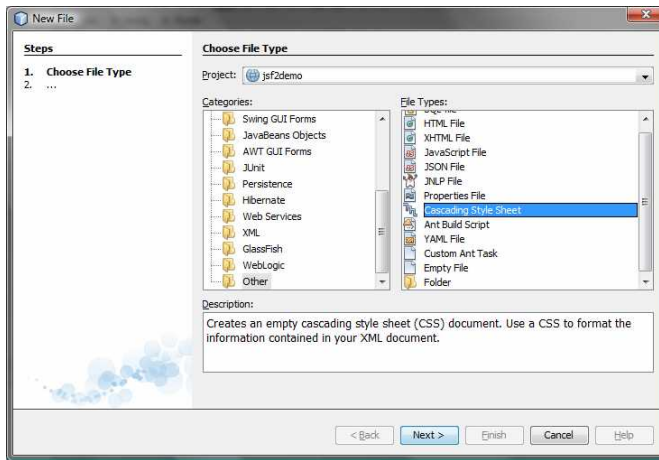
Step 3. Create a cascading style sheet for formatting the table as follows:

Step 3.1. Right-click the `resources` node to choose *New, Others* to display the New File dialog box, as shown in Figure 44.19.

Step 3.2. Choose *Other* in the Categories section and *Cascading Style Sheet* in the File Types section to display the New Cascading Style Sheet dialog box, as shown in Figure 44.20.

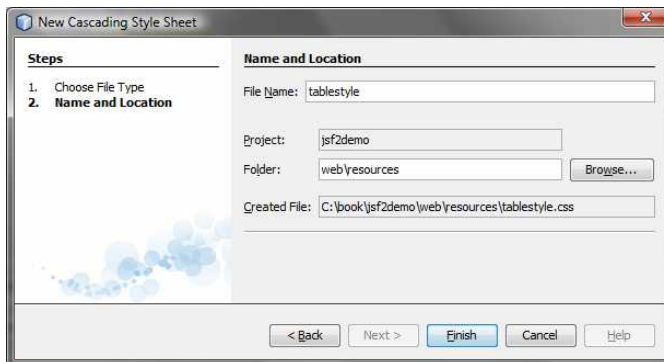
Step 3.3. Enter `tablestyle` as the File Name and click *Finish* to create `tablestyle.css` under the resources node.

Step 3.4. Define the CSS style as shown in Listing 44.15.



**Figure 44.19**

*You can create CSS files for Web project in NetBeans.*



**Figure 44.20**

*The New Cascading Style Sheet dialog box creates a new style sheet file.*

Listing 44.13 `CourseName.java`

**<margin note line 9: application scope>**  
**<margin note line 18: initialize JDBC>**  
**<margin note line 27: connect to database>**  
**<margin note line 32: get course titles>**

<margin note line 34: execute SQL>  
<margin note line 39: titles array>  
<margin note line 72: get student>  
<margin note line 77: set a course>  
<margin note line 83: get rowset>

```
package jsf2demo;

import javax.faces.bean.ManagedBean;
import javax.faces.bean.ApplicationScoped;
import java.sql.*;
import javax.sql.rowset.CachedRowSet;

@ManagedBean
@ApplicationScoped
public class CourseName {
 private PreparedStatement studentStatement = null;
 private CachedRowSet rowSet; // For course titles
 private String choice; // Selected course
 private String[] titles; // Course titles

 /** Creates a new instance of CourseName */
 public CourseName() {
 initializeJdbc();
 }

 /** Initialize database connection */
 private void initializeJdbc() {
 try {
 Class.forName("com.mysql.jdbc.Driver");

 // Connect to the sample database
 Connection connection = DriverManager.getConnection(
 "jdbc:mysql://localhost/javabook", "scott", "tiger");

 // Get course titles
 PreparedStatement statement = connection.prepareStatement(
 "select title from course");
 rowSet = new com.sun.rowset.CachedRowSetImpl();
 rowSet.populate(statement.executeQuery());
 titles = new String[rowSet.size()];
 int i = 0;
 try {
 while (rowSet.next()) {
 titles[i++] = rowSet.getString(1);
 }
 } catch (Exception ex) {
 ex.printStackTrace();
 }

 // Define a SQL statement for getting students
 studentStatement = connection.prepareStatement(
 "select Student.ssn, "
 + "Student.firstName, Student.mi, Student.lastName, "
 + "Student.phone, Student.birthDate, Student.street, "
 + "Student.zipCode, Student.deptId "
 + "from Student, Enrollment, Course "
 + "where Course.title = ? "
 + "and Student.ssn = Enrollment.ssn "
 + "and Enrollment.courseId = Course.courseId;");
 } catch (Exception ex) {
```

```

 ex.printStackTrace();
 }
}

 public String[] getTitles() {
 return titles;
 }

 public String getChoice() {
 return choice;
 }

 public void setChoice(String choice) {
 this.choice = choice;
 }

 public ResultSet getStudents() throws SQLException {
 if (choice == null) {
 if (titles == null)
 return null;
 else
 studentStatement.setString(1, titles[0]);
 } else {
 studentStatement.setString(1, choice); // Set course title
 }

 // Get students for the specified course
 CachedRowSet rowSet = new com.sun.rowset.CachedRowSetImpl();
 rowSet.populate(studentStatement.executeQuery());
 return rowSet;
 }
}

```

We use the same MySQL database **javabook** created in Chapter 33, “Java Database Programming.” The scope for this managed bean is **application**. The bean is created when the project is launched from the server. The database connection is created once in the bean’s constructor (lines 17-19). The `initializeJdbc` method loads the JDBC driver for MySQL (line 24), connects to the MySQL database (lines 25-26), creates statement for obtaining course titles (lines 29-30), and creates a statement for obtaining the student information for the specified course (lines 44-52). Lines 31-41 execute the statement for obtaining course titles and store them in array `titles`.

The `getStudents()` method returns a `ResultSet` that consists of all students enrolled in the specified course (lines 70-84). The choice for the title is set in the statement to obtain the student for the specified title (line 77). If choice is `null`, the first title in the titles array is set in the statement (line 77). If `titles` is `null`, `getStudents()` returns `null` (line 73).

Listing 44.14 DisplayStudent.xhtml

```

<margin note line 9: style sheet>
<margin note line 14: bind choice>
<margin note line 15: titles>
<margin note line 18: display button>
<margin note line 22: bind result set>
<margin note line 23: rowClasses>
<margin note line 24: headerClass>

```

<margin note line 25: styleClass>  
 <margin note line 28: ssn column>  
 <margin note line 33: firstName column>  
 <margin note line 38: mi column>  
 <margin note line 43: lastName column>  
 <margin note line 48: phone column>  
 <margin note line 53: birthDate column>  
 <margin note line 58: deptId column>

```

<?xml version='1.0' encoding='UTF-8' ?>
<!DOCTYPE html PUBLIC "-//W3C//DTD XHTML 1.0 Transitional//EN"
 "http://www.w3.org/TR/xhtml1/DTD/xhtml1-transitional.dtd">
<html xmlns="http://www.w3.org/1999/xhtml"
 xmlns:h="http://java.sun.com/jsf/html"
 xmlns:f="http://java.sun.com/jsf/core">
 <h:head>
 <title>Display Student</title>
 <h:outputStylesheet name="tablestyle.css"/>
 </h:head>
 <h:body>
 <h:form>
 <h:outputLabel value="Choose a Course: " />
 <h:selectOneMenu value="#{courseName.choice}">
 <f:selectItems value="#{courseName.titles}" />
 </h:selectOneMenu>

 <h:commandButton style="margin-left: 20px"
 value="Display Students" />

 <h:dataTable value="#{courseName.students}" var="student"
 rowClasses="oddTableRow, evenTableRow"
 headerClass="tableHeader"
 styleClass="table">
 <h:column>
 <f:facet name="header">SSN</f:facet>
 #{student.ssn}
 </h:column>

 <h:column>
 <f:facet name="header">First Name</f:facet>
 #{student.firstName}
 </h:column>

 <h:column>
 <f:facet name="header">MI</f:facet>
 #{student.mi}
 </h:column>

 <h:column>
 <f:facet name="header">Last Name</f:facet>
 #{student.lastName}
 </h:column>

 <h:column>
 <f:facet name="header">Phone</f:facet>
 #{student.phone}
 </h:column>

 <h:column>

```

```

 <f:facet name="header">Birth Date</f:facet>
 #{student.birthDate}
 </h:column>

 <h:column>
 <f:facet name="header">Dept</f:facet>
 #{student.deptId}
 </h:column>
 </h:dataTable>
 </h:form>
</h:body>
</html>

```

Line 9 specifies that the style sheet `tablestyle.css` created in Step 3 is used in this XHTML file. The `rowClasses = "oddTableRow, evenTableRow"` attribute specifies the style applied to the rows alternately using `oddTableRow` and `evenTableRow` (line 23). The `headerClasses = "tableHeader"` attribute specifies that the `tableHeader` class is used for header style (line 24). The `styleClasses = "table"` attribute specifies that the `table` class is used for the style of all other elements in the table (line 25).

Line 14 binds the `choice` property in the `courseName` bean with the combo box. The selection values in the combo box are bound with the `titles` array property (line 15).

Line 22 binds the table value with a database result set using the attribute `value="#{courseName.students}"`. The `var="student"` attribute associates a row in the result set with `student`. Lines 26-59 specify the column values using `student.ssn` (line 28), `student.firstName` (line 33), `student.mi` (line 38), `student.lastName` (line 33), `student.phone` (line 48), `student.birthDate` (line 53), and `student.deptId` (line 58).

Listing 44.15 `tablestyle.css`

```

<margin note line 2: tableHeader>
<margin note line 14: oddTableRow>
<margin note line 18: evenTableRow>
<margin note line 28: table>

```

```

/* Style for table */
.tableHeader {
 font-family:"Trebuchet MS", Arial, Helvetica, sans-serif;
 border-collapse:collapse;
 font-size:1.1em;
 text-align:left;
 padding-top:5px;
 padding-bottom:4px;
 background-color:#A7C942;
 color:white;
 border:1px solid #98bf21;
}

.oddTableRow {
 border:1px solid #98bf21;
}

.evenTableRow {
 background-color: #eeeeee;
}

```

```

font-size:1em;

padding:3px 7px 2px 7px;

color:#000000;
background-color:#EAF2D3;
}

.table {
border:1px solid green;
}

```

The style sheet file defines the style classes `tableHeader` (line 2) for table header style, `oddTableRow` for odd table rows (line 14), `evenTableRow` for even table rows (line 18), and `table` for all other table elements (line 28).

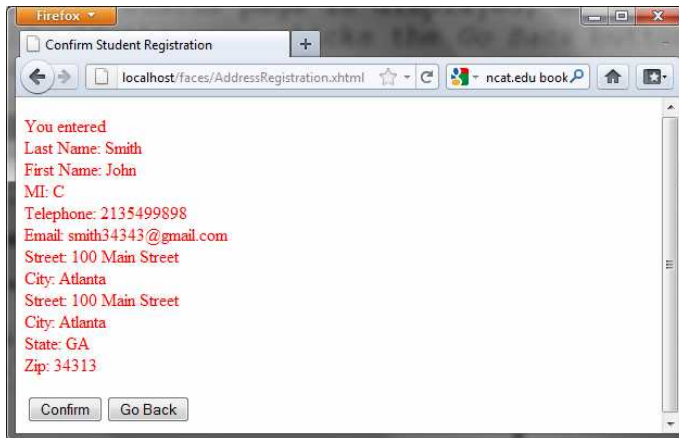
#### 41.9 Opening New JSF Pages

All the examples you have seen so far use only one JSF page in a project. Suppose you want to register student information to the database. The application first displays the page as shown in Figure 44.21 to collection student information. After the user enters the information and clicks the *Submit* button, a new page is displayed to ask the user to confirm the input, as shown in Figure 44.22. If the user clicks the *Confirm* button, the data is stored into the database and the status page is displayed, as shown in Figure 44.23. If the user clicks the *Go Back* button, it goes back to the first page.

The screenshot shows a Firefox browser window with the title 'Student Registration Form'. The address bar shows 'localhost/faces/AddressRegistration.xhtml'. The page content includes a heading 'Student Registration Form' with a small American flag icon. Below the heading is the instruction 'Please register to your instructor's student address book.' The form contains several input fields: 'Last Name' (Smith), 'First Name' (John), 'MI' (C), 'Telephone' (2135499898), 'Email' (smith34343@gmail.com), 'Street' (100 Main Street), 'City' (Atlanta), 'State' (Georgia-GA), and 'Zip' (34313). There is a 'Register' button at the bottom left. A red error message at the bottom reads 'Last Name and First Name are required'.

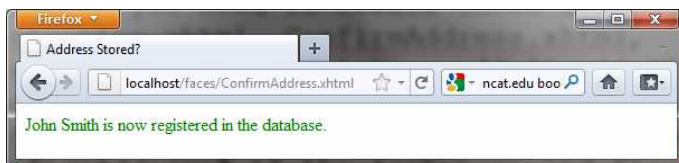
**Figure 44.21**

*This page lets the user enter input.*



**Figure 44.22**

*This page lets the user confirm the input.*



**Figure 44.23**

*This page displays the status of the user input.*

For this project, you need to create three JSP pages named AddressRegistration.xhtml, ConfirmAddress.xhtml, and AddressStoredStatus.xhtml in Listings 44.16, 44.17, and 44.18. The project starts with AddressRegistration.xhtml. When clicking the *Submit* button, the action for the button returns "ConfirmAddress" if the last name and first name are not empty, which causes ConfirmAddress.xhtml to be displayed. When clicking the *Confirm* button, the status page AddressStoredStatus is displayed. When clicking the *Go Back* button, the first page AddressRegistration is now displayed.

Listing 44.16 AddressRegistration.xhtml

```

<margin note line 6: jsf core namespace>
<margin note line 22: bind lastName>
<margin note line 25: bind firstName>
<margin note line 28: bind mi>
<margin note line 34: bind telephone>
<margin note line 37: bind email>
<margin note line 43: bind street>
<margin note line 49: bind city>
<margin note line 52: bind state>
<margin note line 59: bind zip>
<margin note line 64: process register>

<?xml version='1.0' encoding='UTF-8' ?>
<!DOCTYPE html PUBLIC "-//W3C//DTD XHTML 1.0 Transitional//EN"
 "http://www.w3.org/TR/xhtml1/DTD/xhtml1-transitional.dtd">
<html xmlns="http://www.w3.org/1999/xhtml"
 xmlns:h="http://java.sun.com/jsf/html"

```

```

 xmlns:f="http://java.sun.com/jsf/core">
<h:head>
 <title>Student Registration Form</title>
</h:head>
<h:body>
 <h:form>
 <!-- Use h:graphicImage -->
 <h3>Student Registration Form
 <h:graphicImage name="usIcon.gif" library="image"/>
 </h3>

 Please register to your instructor's student address book.
 <!-- Use h:panelGrid -->
 <h:panelGrid columns="6">
 <h:outputLabel value="Last Name" style="color:red"/>
 <h:inputText id="lastNameInputText"
 value="#{addressRegistration.lastName}"/>
 <h:outputLabel value="First Name" style="color:red"/>
 <h:inputText id="firstNameInputText"
 value="#{addressRegistration.firstName}"/>
 <h:outputLabel value="MI" />
 <h:inputText id="miInputText" size="1"
 value="#{addressRegistration.mi}"/>
 </h:panelGrid>

 <h:panelGrid columns="4">
 <h:outputLabel value="Telephone"/>
 <h:inputText id="telephoneInputText"
 value="#{addressRegistration.telephone}"/>
 <h:outputLabel value="Email"/>
 <h:inputText id="emailInputText"
 value="#{addressRegistration.email}"/>
 </h:panelGrid>

 <h:panelGrid columns="4">
 <h:outputLabel value="Street"/>
 <h:inputText id="streetInputText"
 value="#{addressRegistration.street}"/>
 </h:panelGrid>

 <h:panelGrid columns="6">
 <h:outputLabel value="City"/>
 <h:inputText id="cityInputText"
 value="#{addressRegistration.city}"/>
 <h:outputLabel value="State"/>
 <h:selectOneMenu id="stateSelectOneMenu"
 value="#{addressRegistration.state}">
 <f:selectItem itemLabel="Georgia-GA" itemValue="GA" />
 <f:selectItem itemLabel="Oklahoma-OK" itemValue="OK" />
 <f:selectItem itemLabel="Indiana-IN" itemValue="IN" />
 </h:selectOneMenu>
 <h:outputLabel value="Zip"/>
 <h:inputText id="zipInputText"
 value="#{addressRegistration.zip}"/>
 </h:panelGrid>

 <!-- Use command button -->
 <h:commandButton value="Register"
 action="#{addressRegistration.processSubmit()}" />

 <h:outputText escape="false" style="color:red"

```



```

 value="#{addressRegistration.requiredFields}" />
 </h:form>
</h:body>
</html>

```

Listing 44.17 ConfirmAddress.xhtml

*<margin note line 15: process confirm>*  
*<margin note line 17: go to AddressRegistration page>*

```

<?xml version='1.0' encoding='UTF-8' ?>
<!DOCTYPE html PUBLIC "-//W3C//DTD XHTML 1.0 Transitional//EN"
 "http://www.w3.org/TR/xhtml1/DTD/xhtml1-transitional.dtd">
<html xmlns="http://www.w3.org/1999/xhtml"
 xmlns:h="http://java.sun.com/jsf/html">
<h:head>
 <title>Confirm Student Registration</title>
</h:head>
<h:body>
 <h:form>
 <h:outputText escape="false" style="color:red"
 value="#{registration1.input}" />
 <h:panelGrid columns="2">
 <h:commandButton value="Confirm"
 action = "#{registration1.storeStudent()}" />
 <h:commandButton value="Go Back"
 action = "StudentRegistration" />
 </h:panelGrid>
 </h:form>
</h:body>
</html>

```

Listing 44.18 AddressStoredStatus.xhtml

*\*\*\*PD: Please add line numbers in the following code\*\*\**  
*\*\*\*Layout: Please layout exactly. Don't skip the space. This is true for*  
*all source code in the book. Thanks, AU.*  
*<margin note line 12: display status>*

```

<?xml version='1.0' encoding='UTF-8' ?>
<!DOCTYPE html PUBLIC "-//W3C//DTD XHTML 1.0 Transitional//EN"
 "http://www.w3.org/TR/xhtml1/DTD/xhtml1-transitional.dtd">
<html xmlns="http://www.w3.org/1999/xhtml"
 xmlns:h="http://java.sun.com/jsf/html">
<h:head>
 <title>Address Stored?</title>
</h:head>
<h:body>
 <h:form>
 <h:outputText escape="false" style="color:green"
 value="#{registration1.status}" />
 </h:form>
</h:body>
</html>

```

Listing 44.19 AddressRegistration.java

<margin note line 7: managed bean>  
<margin note line 8: session scope>  
<margin note line 10: property lastName>  
<margin note line 24: initialize database>  
<margin note line 107: go to a new page>  
<margin note line 113: check required fields>  
<margin note line 121: get input>  
<margin note line 157: store address>  
<margin note line 169: update status>  
<margin note line 175: go to a new page>

```
package jsf2demo;

import javax.faces.bean.ManagedBean;
import javax.faces.bean.SessionScoped;
import java.sql.*;

@ManagedBean
@SessionScoped
public class AddressRegistration {
 private String lastName;
 private String firstName;
 private String mi;
 private String telephone;
 private String email;
 private String street;
 private String city;
 private String state;
 private String zip;
 private String status = "Nothing stored";
 // Use a prepared statement to store a student into the database
 private PreparedStatement pstmt;

 public AddressRegistration() {
 initializeJdbc();
 }

 public String getLastName() {
 return lastName;
 }

 public void setLastName(String lastName) {
 this.lastName = lastName;
 }

 public String getFirstName() {
 return firstName;
 }

 public void setFirstName(String firstName) {
 this.firstName = firstName;
 }

 public String getMi() {
 return mi;
 }

 public void setMi(String mi) {
 this.mi = mi;
 }
}
```

```

public String getTelephone() {
 return telephone;
}

public void setTelephone(String telephone) {
 this.telephone = telephone;
}

public String getEmail() {
 return email;
}

public void setEmail(String email) {
 this.email = email;
}

public String getStreet() {
 return street;
}

public void setStreet(String street) {
 this.street = street;
}

public String getCity() {
 return city;
}

public void setCity(String city) {
 this.city = city;
}

public String getState() {
 return state;
}

public void setState(String state) {
 this.state = state;
}

public String getZip() {
 return zip;
}

public void setZip(String zip) {
 this.zip = zip;
}

private boolean isRquiredFieldsFilled() {
 return !(lastName == null || firstName == null
 || lastName.trim().length() == 0
 || firstName.trim().length() == 0);
}

public String processSubmit() {
 if (isRquiredFieldsFilled()) {
 return "ConfirmAddress";
 } else {
 return "";
 }
}

```

```

}

public String getRequiredFields() {
 if (isRequiredFieldsFilled()) {
 return "";
 } else {
 return "Last Name and First Name are required";
 }
}

public String getInput() {
 return "<p style=\"color:red\">You entered
"
 + "Last Name: " + lastName + "
"
 + "First Name: " + firstName + "
"
 + "MI: " + mi + "
"
 + "Telephone: " + telephone + "
"
 + "Email: " + email + "
"
 + "Street: " + street + "
"
 + "City: " + city + "
"
 + "Street: " + street + "
"
 + "City: " + city + "
"
 + "State: " + state + "
"
 + "Zip: " + zip + "</p>";
}

/** Initialize database connection */
private void initializeJdbc() {
 try {
 // Explicitly load a MySQL driver
 Class.forName("com.mysql.jdbc.Driver");
 System.out.println("Driver loaded");

 // Establish a connection
 Connection conn = DriverManager.getConnection(
 "jdbc:mysql://localhost/javabook", "scott", "tiger");

 // Create a Statement
 pstmt = conn.prepareStatement("insert into Address (lastName,"
 + " firstName, mi, telephone, email, street, city, "
 + "state, zip) values (?, ?, ?, ?, ?, ?, ?, ?, ?)");
 } catch (Exception ex) {
 System.out.println(ex);
 }
}

/** Store an address to the database */
public String storeStudent() {
 try {
 pstmt.setString(1, lastName);
 pstmt.setString(2, firstName);
 pstmt.setString(3, mi);
 pstmt.setString(4, telephone);
 pstmt.setString(5, email);
 pstmt.setString(6, street);
 pstmt.setString(7, city);
 pstmt.setString(8, state);
 pstmt.setString(9, zip);
 pstmt.executeUpdate();
 status = firstName + " " + lastName
 + " is now registered in the database.";
 } catch (Exception ex) {

```

```

 status = ex.getMessage();
 }

 return "AddressStoredStatus";
}

public String getStatus() {
 return status;
}
}

```

The action for the *Register* button in the *AddressRegistration* JSF page is processSubmit() (line 64 in *AddressRegistration.xhtml*). This method checks if last name and first name are not empty (lines 105-111 in *AddressRegistration.java*). If so, it returns a string "ConfirmAddress", which causes the *ConfirmAddress* JSF page to be displayed.

The *ConfirmAddress* JSF page displays the data entered from the user (line 12 in *ConfirmAddress.xhtml*). The getInput() method (lines 121-134 in *AddressRegistration.java*) collects the input.

The action for the *Confirm* button in the *ConfirmAddress* JSF page is storeStudent() (line 15 in *ConfirmAddress.xhtml*). This method stores the address in the database (lines 157-176 in *AddressRegistration.java*) and returns a string "AddressStoredStatus", which causes the *AddressStoredStatus* page to be displayed. The status message is displayed in this page (line 12 in *AddressStoredStatus.xhtml*).

The action for the *Go Back* button in the *ConfirmAddress* page is "AddressRegistration" (line 17 in *ConfirmAddress.xhtml*). This causes the *AddressRegistration* page to be displayed for the user to reenter the input.

The scope of the managed bean is session (line 8 *AddressRegistration.java*) so the multiple pages can share the same bean.

Note that this program loads the database driver explicitly (line 140 *AddressRegistration.java*). Sometimes, an IDE such as NetBeans is not able to find a suitable driver. Loading a driver explicitly can avoid this problem.

### Chapter Summary

1. JSF enables you to completely separate Java code from HTML.
2. A facelet is an XHTML page that mixes JSF tags with XHTML tags.
3. JSF applications are developed using the Model-View-Controller (MVC) architecture, which separates the application's data (contained in the model) from the graphical presentation (the view).
4. The controller is the JSF framework that is responsible for coordinating interactions between view and the model.
5. In JSF, the facelets are the view for presenting data. Data are obtained from Java objects. Objects are defined using Java classes.

6. In JSF, the objects that are accessed from a facelet are JavaBeans objects.
7. The JSF expression can either use the property name or invoke the method to obtain the current time.
8. JSF provides many elements for displaying GUI components. The tags with the h prefix are in the JSF HTML Tag library. The tags with the f prefix are in the JSF Core Tag library.
9. You can specify the JavaBeans objects at the application scope, session scope, page scope, view scope, or request scope.
10. The view scope keeps the bean alive as long as you stay on the view. The view scope is between session and request scopes.
11. JSF provides several convenient and powerful ways for input validation. You can use the standard validator tags in the JSF Core Tag Library or create custom validators.

### Test Questions

Do the test questions for this chapter online at [www.cs.armstrong.edu/liang/intro9e/test.html](http://www.cs.armstrong.edu/liang/intro9e/test.html).

### Review Questions

#### Section 44.2

- 44.1 What is JSF?
- 44.2 How do you create a JSF project in NetBeans?
- 44.3 How do you create a JSF page in a JSF project?
- 44.4 What is a facelet?
- 44.5 What is the file extension name for a facelet?
- 44.6 What is a managed bean?
- 44.7 What is the `@ManagedBean` annotation for?
- 44.8 What is the `@RequestScope` annotation for?
- 44.9 What is the name space for JSF tags with prefix h and prefix f?

#### Sections 44.3-44.5

- 44.10 Describe the use of the following tags?

h:form, h:panelGroup, h:panelGrid, h:inputText, h:outputText,  
h:inputTextArea, h:inputSecret, h:outputLabel, h:outputLink,  
h:selectOneMenu, h:selectOneRadio, h:selectBooleanCheckbox,  
h:selectOneListbox, h:selectManyListbox, h:selectItem, h:message,  
h:dataTable, h:column, h:graphicImage

- 44.11 In the h:outputText tag, what is the `escape` attribute for?
- 44.12 Does every GUI component tag in JSF have the `style` attribute?

### Section 44.6

- 44.13 What is a JSF session scope?
- 44.14 How do you set a session scope in a managed bean?
- 44.15 Describe the four session scopes.
- 44.16 What is the default session scope?

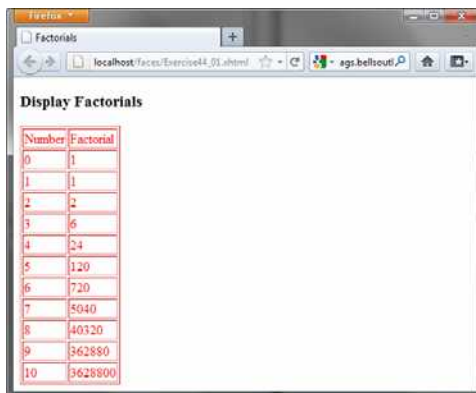
### Section 44.7

- 44.17 Write a tag that validates an input text with minimal length of 2 and maximum 12.
- 44.18 Write a tag that validates an input text for SSN using a regular expression.
- 44.19 Write a tag that validates an input text for a double value with minimal 4.5 and maximum 19.9.
- 44.20 Write a tag that validates an input text for an integer value with minimal 4 and maximum 20.
- 44.21 Write a tag that make an input text required.

### Programming Exercises

44.1\*

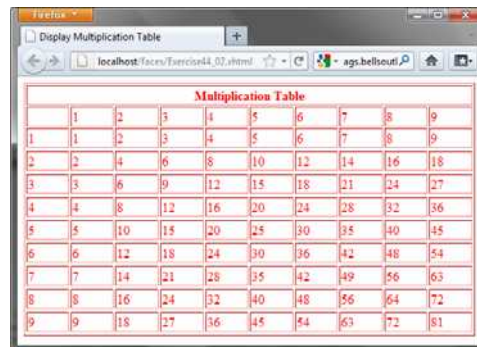
(*Factorial table in JSF*) Write a JSF page that displays a factorial page as shown in Figure 44.24a. Display the table in an `h:outputText` component. Set its `escape` property to `false` to display it as HTML contents.



The screenshot shows a web browser window titled 'Factorials'. The address bar shows 'localhost/faces/Exercice44\_01.html'. The page content is titled 'Display Factorials' and contains a table with two columns: 'Number' and 'Factorial'. The table lists factorials from 0 to 10.

Number	Factorial
0	1
1	1
2	2
3	6
4	24
5	120
6	720
7	5040
8	40320
9	362880
10	3628800

(a)



The screenshot shows a web browser window titled 'Display Multiplication Table'. The address bar shows 'localhost/faces/Exercice44\_02.html'. The page content is titled 'Multiplication Table' and contains a 10x10 grid of numbers representing the multiplication table for integers 1 through 9.

	1	2	3	4	5	6	7	8	9
1	1	2	3	4	5	6	7	8	9
2	2	4	6	8	10	12	14	16	18
3	3	6	9	12	15	18	21	24	27
4	4	8	12	16	20	24	28	32	36
5	5	10	15	20	25	30	35	40	45
6	6	12	18	24	30	36	42	48	54
7	7	14	21	28	35	42	49	56	63
8	8	16	24	32	40	48	56	64	72
9	9	18	27	36	45	54	63	72	81

(b)

Figure 44.24

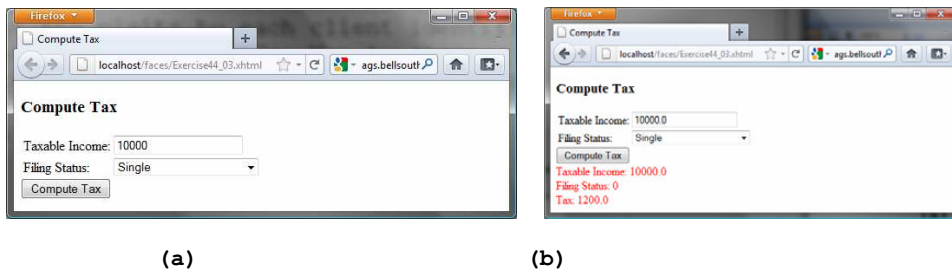
(a) The JSF page displays factorials for the numbers from 0 to 10 in a table. (b) The JSF page displays the multiplication table.

44.2\*

(Multiplication table) Write a JSF page that displays a multiplication table as shown in Figure 44.24b.

44.3\*

(Calculate tax) Write a JSF page to let the user to enter taxable income and filing status, as shown in Figure 44.25a. Clicking the *Compute Tax* button invokes a servlet to compute and display the tax, as shown in Figure 44.25b. Use the `computeTax` method introduced in Listing 3.7, `ComputeTax.java`, to compute tax.

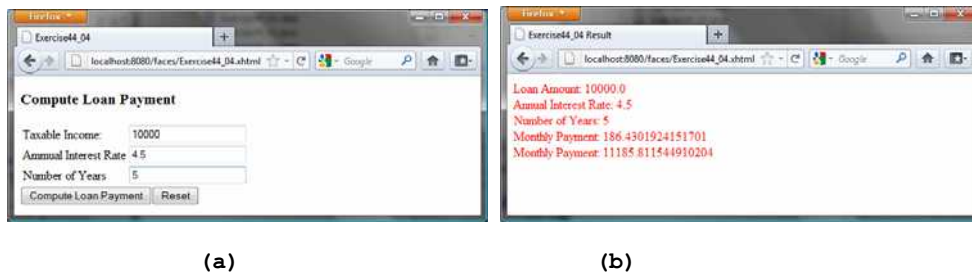


**Figure 44.25**

*The JSF page computes the tax.*

44.4\*

(Calculate loan) Write a JSF page that lets the user enter loan amount, interest rate, and number of years, as shown in Figure 44.26a. Clicking the *Compute Loan Payment* button to compute and display the monthly and total loan payments, as shown in Figure 44.26b. Use the `Loan` class given in Listing 10.2, `Loan.java`, to compute the monthly and total payments.



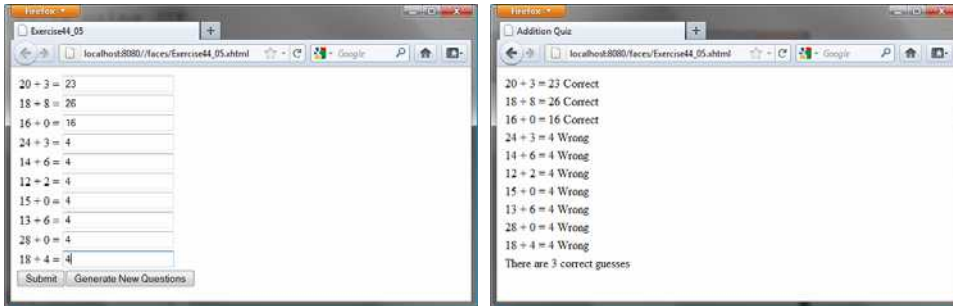
**Figure 44.26**

*The JSF page computes the loan payment.*



44.5\*

(Addition quiz) Write a JSP program that generates addition quizzes randomly, as shown in Figure 44.27a. After the user answers all questions, the JSP displays the result, as shown in Figure 44.27b.



(a)

(b)

Figure 44.27

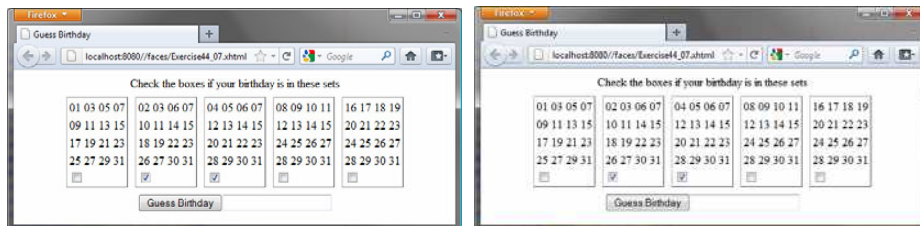
The program displays addition questions in (a) and answers in (b).

43.18\*

(Large factorial) Rewrite Exercise 44.1 to handle large factorial. Use the `BigInteger` class introduced in §15.11.

44.7\*

(Guess birthday) Listing 3.3, `GuessBirthday.java`, gives a program for guessing a birthday. Write a JSP program that displays five sets of numbers, as shown in Figure 44.28a. After the user checks the appropriate boxes and clicks the *Find Date* button, the program displays the date, as shown in Figure 44.28b.



(a)

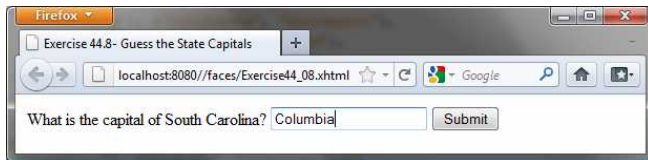
(b)

Figure 44.28

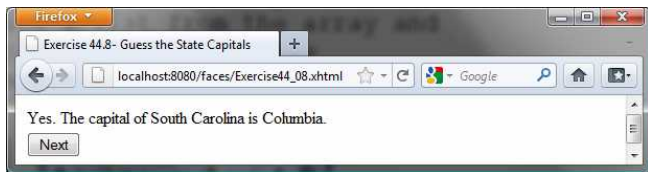
(a) The program displays five sets of numbers for the user to check the boxes. (b) The program displays the date.

44.8\*

(Guess capitals) Write a JSF that prompts the user to enter a capital for a state, as shown in Figure 44.29a. Upon receiving the user input, the program reports whether the answer is correct, as shown in Figure 44.29b. You can click the Next button to display another question. You can use a two-dimensional array to store the states and capitals, as proposed in Exercise 9.22. Create a list from the array and apply the `shuffle` method to reorder the list so the questions will appear in random order.



(a)



(b)

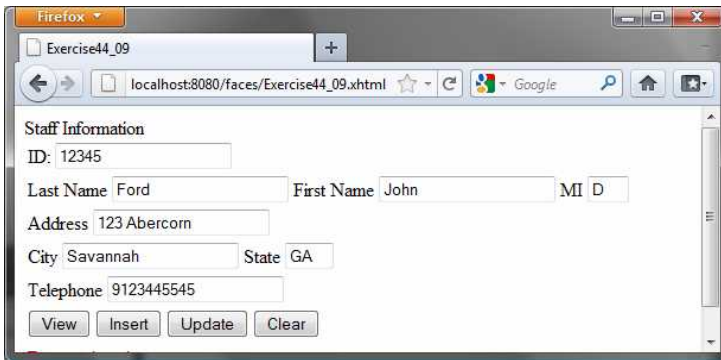
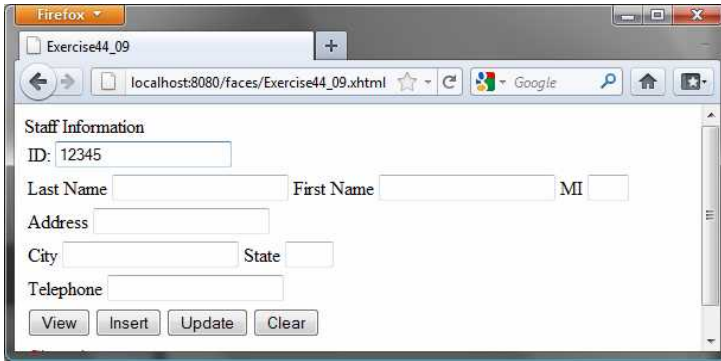
Figure 44.29

(a) The program displays a question. (b) The program displays the answer to the question.

44.9\*

(Access and update a `Staff` table) Write a JSF program that views, inserts, and updates staff information stored in a database, as shown in Figure 44.30a. The view button displays a record with a specified ID. The `Staff` table is created as follows:

```
create table Staff (
 id char(9) not null,
 lastName varchar(15),
 firstName varchar(15),
 mi char(1),
 address varchar(20),
 city varchar(20),
 state char(2),
 telephone char(10),
 email varchar(40),
 primary key (id)
);
```



**Figure 44.30**

*The web page lets you view, insert, and update staff information.*

44.10\*

(Random cards) Write a JSF that displays four random cards from a deck of 52 cards, as shown in Figure 44.22. When the user clicks the *Refresh* button, four new random cards are displayed.



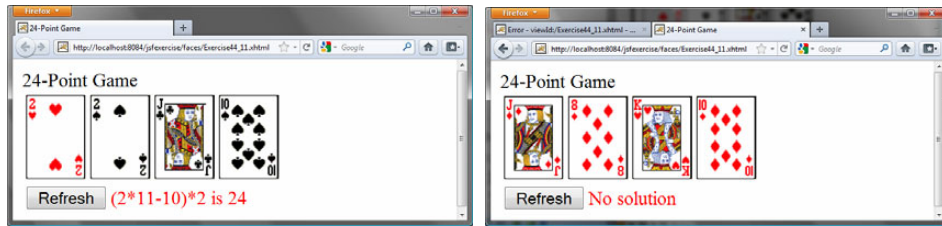
**Figure 44.22**

*This JSF application displays four random cards.*

44.11\*\*\*

(Game: the 24-point card game) Rewrite Exercise 25.11 using JSF, as shown in Figure 44.23. Upon clicking the *Refresh* button, the program

displays four random cards and displays an expression if a 24-point solution exists. Otherwise, it displays No solution.

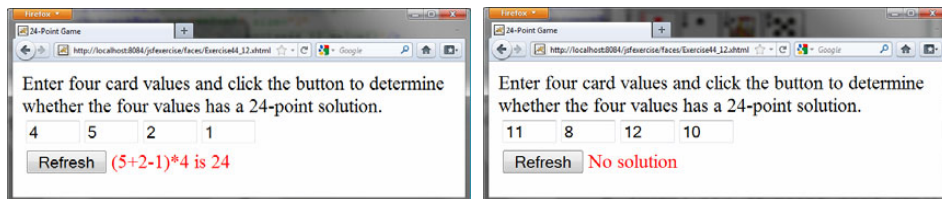


**Figure 44.23**

*The JSF application solves a 24-Point card game.*

44.12\*\*\*

(Game: the 24-point card game) Rewrite Exercise 25.10 using JSF, as shown in Figure 44.24. The program lets the user enter four card values and finds a solution upon clicking the *Find a Solution* button.



**Figure 44.24**

*The user enters four numbers and the program finds a solution.*

*\*\*\*This is a bonus Web chapter*

## **CHAPTER 45**

### **Web Services**

#### Objectives

- To describe what a Web service is (§45.1).
- To create a Web service class (§45.2).
- To publish and test a Web service (§45.3).
- To create a Web service client reference (§45.4).
- To explain the role of WSDL (§45.4).
- To pass arguments of object type in a Web service (§45.5).
- To discover how a client communicates with a Web service (§45.5).
- To describe what SOAP requests and SOAP responses are (§45.5).
- To track a session in Web services (§45.6).

## 45.1 Introduction

<Side Remark: platform independent>

<Side Remark: language independent>

Web service is a technology that enables programs to communicate through HTTP on the Internet. Web services enable a program on one system to invoke a method in an object on another system. You can develop and use Web services using any languages on any platform. Web services are simple and easy to develop.

<Side Remark: SOAP>

<Side Remark: publishing Web services>

<Side Remark: consuming Web services>

Web services run on the Web using HTTP. There are several APIs for Web services. A popular standard is the *Simple Object Access Protocol* (SOAP), which is based on XML. The computer on which a Web service resides is referred to as a *server*. The server needs to make the service available to the client, known as *publishing a Web service*. Using a Web service from a client is known as *consuming a Web service*.

<Side Remark: proxy object>

A client interacts with a Web service through a *proxy object*. The proxy object facilitates the communication between the client and the Web service. The client passes arguments to invoke methods on the proxy object. The proxy object sends the request to the server and receives the result back from the server, as shown in Figure 45.1.

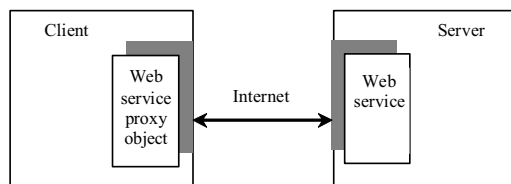


Figure 45.1

A proxy object serves as a facilitator between a client and a Web service.

## 45.2 Creating Web Services

<Side Remark: Web service tool>

There are many tools for creating Web services. This book demonstrates creating Web services using NetBeans.

<Side Remark: install GlashFish 3>

NOTE:

Apache Tomcat Server does not work well with Web services. To develop and deploy Web services using NetBeans, you need to install GlassFish 3. For information on how to install GlassFish 3 on NetBeans 7, see Supplement II.I.

\*\*\*END NOTE

We now create a Web service for obtaining student scores. A Web service is a class that contains the methods for the client to invoke. Name the class `ScoreService` with a method named `findScore(String name)` that returns the score for a student.

<Side Remark: NetBeans Web project>

First you need to create a *Web project* using the following steps:

Choose **File > New Project** to display the New Project dialog box.

In the New Project dialog box, choose **Java Web** in the Categories pane and choose **Web Application** in the Projects pane. Click **Next** to display the New Web Application dialog box. Enter WebServiceProject as the project name, specify the location where you want the project to be stored, and click **Next** to display the Server and Setting dialog. Select **GlassFish 3** as the server and **Java EE 6 Web** as the Java EE version. Click **Finish** to create the project.

**<Side Remark: create Web service class>**

Now you can create the ScoreService class in the project as follows:

Right-click the WebServiceProject in the Project pane to display a context menu. Choose **New > Web Service** to display the New Web Service dialog box.

Enter ScoreService in the Web Service Name field and enter chapter45 in the Package field. Click **Finish** to create ScoreService.

Complete the source code as shown in Listing 45.1.

Listing 45.1 ScoreService.java

**<Side Remark line 4: import for @WebService>**

**<Side Remark line 5: import for @WebMethod>**

**<Side Remark line 7: define WebService>**

**<Side Remark line 19: define WebMethod>**

```
package chapter45;

import java.util.HashMap;
import javax.jws.WebService; // For annotation @WebService
import javax.jws.WebMethod; // For annotation @WebMethod

@WebService(name = "ScoreService", serviceName = "ScoreWebService")
public class ScoreService {
 // Stores scores in a map indexed by name
 private HashMap<String, Double> scores =
 new HashMap<String, Double>();

 public ScoreService() {
 scores.put("John", 90.5);
 scores.put("Michael", 100.0);
 scores.put("Michelle", 98.5);
 }

 @WebMethod(operationName = "findScore")
 public double findScore(String name) {
 Double d = scores.get(name);

 if (d == null) {
 System.out.println("Student " + name + " is not found ");
 return -1;
 }
 else {
 System.out.println("Student " + name + "'s score is "
 + d.doubleValue());
 return d.doubleValue();
 }
 }
}
```

```
}
```

<Side Remark: what is annotation?>

<Side Remark: boilerplate code>

Lines 4-5 import the annotations used in the program in lines 7 and 19. Annotation is a new feature in Java, which enables you to simplify coding. The compiler will automatically generate the code for the annotated directives. So, it frees the programmer from writing the detailed *boilerplate code* that could be generated mechanically. The annotation (line 7)

```
@WebService(name = "ScoreService", serviceName = "ScoreWebService")
```

tells the compiler that the class `ScoreService` is associated with the Web service named `ScoreWebService`.

The annotation (line 19)

```
@WebMethod(operationName = "findScore")
```

indicates that `findScore` is a method that can be invoked from a client.

The `findScore` method returns a score if the name is in the hash map. Otherwise, it returns `-1.0`.

You can manually type the code for the service, or create it from the Design tab, as shown in Figure 45.2.

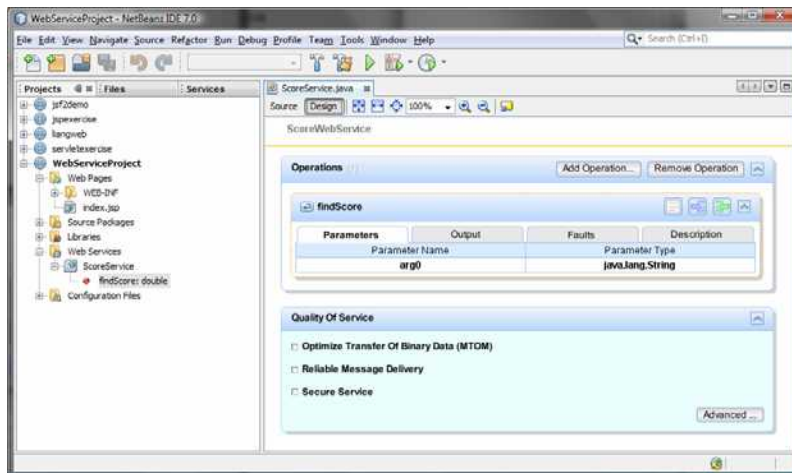


Figure 45.2

The services can also be created from the Design pane.

### 45.3 Deploying and Testing Web Services

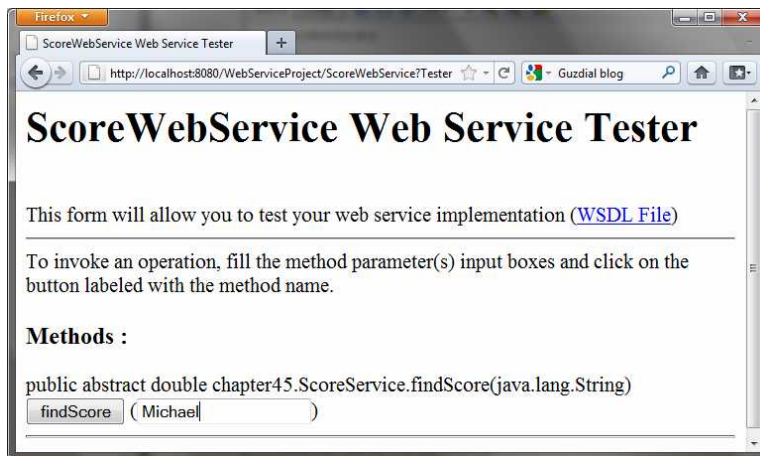
<Side Remark: publishing Web services>

After a Web service is created, you need to deploy it for clients to use. Deploying Web services is also known as *publishing Web services*. To deploy it, right-click the `WebServiceProject` in the Project to display a context menu and choose **Deploy**. This command will first undeploy the service if it was deployed and then redeploy it.

Now you can test the Web service by entering the follow URL in a browser, as shown in Figure 45.3.



http://localhost:8080/WebServiceProject/ScoreWebService?Tester

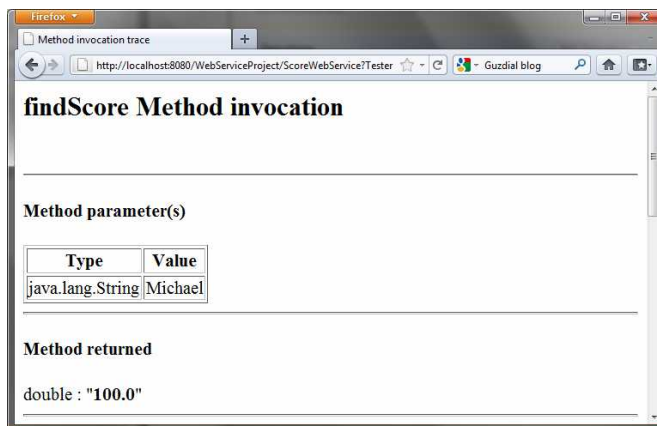


**Figure 45.3**

*The test page enables you to test Web services.*

Note that `ScoreWebService` is the name you specified in line 7 in Listing 45.1. This Web service has only one remote method named `findScore`. You can define an unlimited number of remote methods in a Web service class. If so, all these methods will be displayed in the test page.

To test the `findScore` method, enter `Michael` and click `findScore`. You will see that the method returns `100.0`, as shown in Figure 45.4.



**Figure 45.4**

*The method returns a test value.*

**<Side Remark: testing from another machine>**

NOTE: If your computer is connected to the Internet, you can test Web services from another computer by entering the following URL:

http://**host**:8080/WebServiceProject/ScoreWebService?Tester

**<Side Remark: ipconfig>**

Where *host* is the host name or IP address of the server on which the Web service is running. On Windows, you can find your IP address by typing the command *ipconfig*.

**\*\*\*END NOTE**

**<Side Remark: Windows firewall>**

NOTE: If you are running the server on Windows, the firewall may prevent remote clients from accessing the service. To enable it, do the following:

1. In the Windows control panel, click Windows Firewall to display the Windows Firewall dialog box.
2. In the Advanced tab, double-click Local Area Connection to display the Advanced Settings dialog box. Check *Web Server(HTTP)* to enable HTTP access to the server.
3. Click *OK* to close the dialog box.

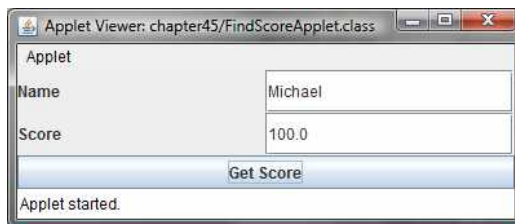
**\*\*\*END NOTE**

#### 45.4 Consuming Web Services

**<Side Remark: consuming Web services>**

After a Web service is published, you can write a client program to use it. A client can be any program (standalone application, applet, servlet/JSP/JSF application, or another Web service) and written in any language.

We will use NetBeans to create a Web service client. Our client is a Java applet with a main method, so you can also run it standalone. The applet simply lets the user enter a name and displays the score, as shown in Figure 45.5.



**Figure 45.5**

*The applet client uses the Web service to find scores.*

Let us create a project for the client. The project named ScoreWebServiceClientProject can be created as follows:

Choose **File > New Project** to display the New Project dialog box. In the New Project dialog box, choose **Java** in the Categories pane and choose **Java Application** in the Projects pane. Click *Next* to display the New Java Application dialog box. Enter ScoreWebServiceClientProject as the project name, specify the location where you want the project to be stored, and uncheck the *Create Main Class* check box. Click *Finish* to create the project.

**<Side Remark: Web service reference>**

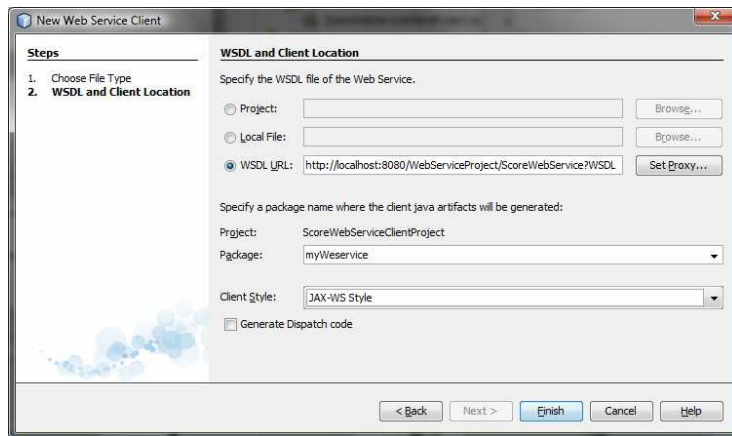
You need to create a Web service reference to this project. The reference will enable you to create a proxy object to interact with the Web service. Here are the steps to create a Web service reference:

Right-click the `ScoreWebServiceClientProject` in the Project pane to display a context menu. Choose **New > Web Service Client** to display the New Web Service Client dialog box, as shown in Figure 45.6.

Check the *WSDL URL* radio button and enter

`http://localhost:8080/WebServiceProject/ScoreWebService?WSDL`  
in the WSDL URL field.

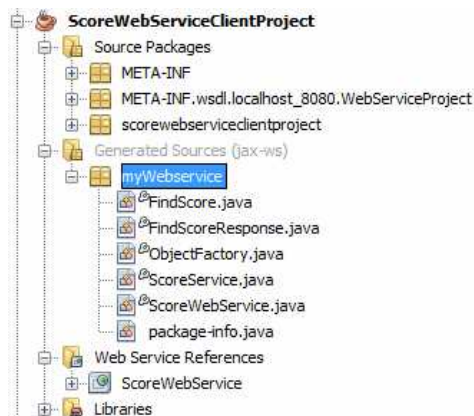
Enter `myWebservice` in the package name field and choose **JAX-WS** as the JAX version. Click *Finish* to generate the Web service reference.



**Figure 45.6**

*The New Web Service Client dialog box creates a Web service reference.*

Now you will see `ScoreWebService` created in the Web Service References folder in the Projects tab. The IDE has generated many supporting files for the reference. You can view all the generated .java files from the Files tab in the project pane, as shown in Figure 45.7. These files will be used by the proxy object to interact with the Web service.



**Figure 45.7**

*You can see the automatically generated boilerplate code for Web services in the Generated Sources folder in the client's project.*

<Side Remark: what is WSDL?>

NOTE: When you created a Web service reference, you entered a WSDL URL, as shown in Figure 45.6. This creates a .wsdl file. In this case, it is named ScoreWebService.wsdl under the Web Service References folder, as shown in Figure 45.8. So *what is WSDL?* WSDL stands for *Web Service Description Language*. A .wsdl file is an XML file that describes the available Web service to the client—i.e., the remote methods, their parameters and return value types, and so on.

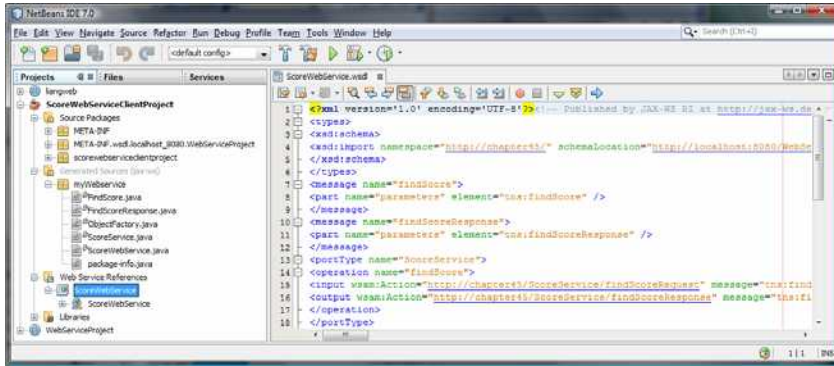


Figure 45.8  
The .wsdl file describes Web services to clients.

<Side Remark: refresh reference>

NOTE: If the Web service is modified, you need to refresh the reference for the client. To do so, right-click the Web service node under Web Service References to display a context menu and choose **Refresh Client**.

Now you are ready to create an applet client for the Web service. Right-click the `ScoreWebServiceClientProject` node in the Project pane to display a context menu, and choose **New > JApplet** to create a Java applet named `FindScoreApplet` in package `chapter45`, as shown in Listing 45.2.

Listing 45.2 FindScoreApplet.java

- <Side Remark line 11: create a service object>
- <Side Remark line 12: create a proxy object>
- <Side Remark line 39: invoke remote method>
- <Side Remark line 51: main method omitted>

```
package chapter45;

import myWebservice.ScoreWebService;
import myWebservice.ScoreService;
import javax.swing.*;
import java.awt.*;
import java.awt.event.*;

public class FindScoreApplet extends JApplet {
 // Declare a service object and a proxy object
 private ScoreWebService scoreWebService = new ScoreWebService();
 private ScoreService proxy = scoreWebService.getScoreServicePort();

 private JButton jbtGetScore = new JButton("Get Score");
```

```

private JTextField jtfName = new JTextField();
private JTextField jtfScore = new JTextField();

public void init() {
 JPanel jPanel1 = new JPanel();
 jPanel1.setLayout(new GridLayout(2, 2));
 jPanel1.add(new JLabel("Name"));
 jPanel1.add(jtfName);
 jPanel1.add(new JLabel("Score"));
 jPanel1.add(jtfScore);

 add(jbtGetScore, BorderLayout.SOUTH);
 add(jPanel1, BorderLayout.CENTER);

 jbtGetScore.addActionListener(new ActionListener() {
 public void actionPerformed(ActionEvent evt) {
 getScore();
 }
 });
}

private void getScore() {
 try {
 // Get student score
 double score = proxy.findScore(jtfName.getText().trim());

 // Display the result
 if (score < 0)
 jtfScore.setText("Not found");
 else
 jtfScore.setText(new Double(score).toString());
 }
 catch(Exception ex) {
 ex.printStackTrace();
 }
}
}

```

The program creates a Web service object (line 11) and creates a proxy object (line 12) to interact with the Web service.

To find a score for a student, the program invokes the remote method `findScore` on the proxy object (line 39).

#### 45.5 Passing and Returning Arguments

##### <Side Remark: SOAP>

In the preceding example, a Web service client that you created invokes the `findScore` method with a string argument, and the Web service executes the method and returns a score as a `double` value. How does this work? It is the *Simple Object Access Protocol* (SOAP) that facilitates communications between the client and server.

##### <Side Remark: SOAP request>

##### <Side Remark: SOAP response>

SOAP is based on XML. The message between the client and server is described in XML. Figure 45.9 shows the SOAP request and SOAP response for the `findScore` method.

**findScore Method invocation**

---

**Method parameter(s)**

Type	Value
java.lang.String	Michael

---

**Method returned**

double : "100.0"

---

**SOAP Request**

```
<?xml version="1.0" encoding="UTF-8"?>
<S:Envelope xmlns:S="http://schemas.xmlsoap.org/soap/envelope/">
 <S:Header/>
 <S:Body>
 <ns2:findScore xmlns:ns2="http://chapter45/">
 <arg0>Michael</arg0>
 </ns2:findScore>
 </S:Body>
</S:Envelope>
```

---

**SOAP Response**

```
<?xml version="1.0" encoding="UTF-8"?>
<S:Envelope xmlns:S="http://schemas.xmlsoap.org/soap/envelope/">
 <S:Body>
 <ns2:findScoreResponse xmlns:ns2="http://chapter45/">
 <return>100.0</return>
 </ns2:findScoreResponse>
 </S:Body>
</S:Envelope>
```

**Figure 45.9**

*The client request and server response are described in XML.*

When invoking the `findScore` method, a SOAP request is sent to the server. The request contains the information about the method and the argument. As shown in Figure 45.9, the XML text

```
<ns1:findScore>
 <arg0>Michael</arg0>
</ns1:findScore>
```

specifies that the method `findScore` is called with argument Michael.

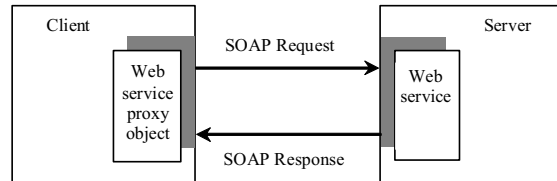
Upon receiving the SOAP request, the Web service parses it. After parsing it, the Web service invokes an appropriate method with

specified arguments (if any) and sends the response back in a *SOAP response*. As shown in Figure 45.9, the XML text

```
<ns1:findScoreResponse>
 <return>100.0</return>
</ns1:findScoreResponse>
```

specifies that the method returns 100.0.

The proxy object receives the SOAP response from the Web service and parses it. This process is illustrated in Figure 45.10.



**Figure 45.10**

*A proxy object sends SOAP requests and receives SOAP responses.*

**<Side Remark: XML serialization>**

**<Side Remark: XML deserialization>**

Can you pass an argument of any type between a client and a Web service? No. SOAP supports only primitive types, wrapper types, arrays, String, Date, Time, List, and several other types. It also supports certain custom classes. An object that is sent to or from a server is serialized into XML. The process of serializing/deserializing objects, called *XML serialization/deserialization*, is performed automatically. For a custom class to be used with Web methods, the class must meet the following requirements:

**<Side Remark: no-arg constructor>**

The class must have a no-arg constructor.

**<Side Remark: get and set methods>**

Instance variables that should be serialized must have public get and set methods. The classes of these variables must be supported by SOAP.

To demonstrate how to pass an object argument of a custom class, Listing 45.3 defines a Web service class named AddressService with two remote methods:

getAddress(String firstName, String lastName) that returns an Address object for the specified firstName and lastName.  
storeAddress(Address address) that stores a Student object to the database.

Address information is stored in a table named Address in the database. The Address class was defined in Listing 42.12, Address.java. An Address object can be passed to or returned from a remote method, since the Address class has a no-arg constructor with get and set methods for all its properties.

Here are the steps to create a Web service named AddressService and the Address class in the project.

Right-click the WebServiceProject node in the project pane to display a context menu. Choose **New > Web Service** to display the New Web Service dialog box. In the Web Service Name field, enter AddressService. In the Package field, enter chapter45. Click *Finish* to create the service class.

Right-click the `WebServiceProject` node in the project pane to display a context menu. Choose **New > Java Class** to display the New Java Class dialog box. In the Class Name field, enter `Address`. In the Package field, enter `chapter42`. Click *Finish* to create the class.

The `Address` class is the same as shown in Listing 42.12. Complete the `AddressService` class as shown in Listing 45.3.

#### Listing 45.3 AddressService.java

<Side Remark line 8: define service name>  
<Side Remark line 12: prepared statement>  
<Side Remark line 15: prepared statement>  
<Side Remark line 18: initialize database>  
<Side Remark line 21: define remote method>  
<Side Remark line 22: `getAddress`>  
<Side Remark line 49: define remote method>  
<Side Remark line 50: `storeAddress`>  
<Side Remark line 68: initialize database>

```
package chapter45;

import chapter42.Address;
import java.sql.*;
import javax.jws.WebMethod;
import javax.jws.WebService;

@WebService(name = "AddressService",
 serviceName = "AddressWebService")
public class AddressService {
 // statement1 for retrieving an address and statement2 for storing
 private PreparedStatement statement1;

 // statement2 for storing an address
 private PreparedStatement statement2;

 public AddressService() {
 initializeJdbc();
 }

 @WebMethod(operationName = "getAddress")
 public Address getAddress(String firstName, String lastName) {
 try {
 statement1.setString(1, firstName);
 statement1.setString(2, lastName);
 ResultSet resultSet = statement1.executeQuery();

 if (resultSet.next()) {
 Address address = new Address();
 address.setFirstName(resultSet.getString("firstName"));
 address.setLastName(resultSet.getString("lastName"));
 address.setMi(resultSet.getString("mi"));
 address.setTelephone(resultSet.getString("telephone"));
 address.setFirstNumber(resultSet.getString("email"));
 address.setCity(resultSet.getString("telephone"));
 address.setState(resultSet.getString("state"));
 address.setZip(resultSet.getString("zip"));
 }
 }
 }
}
```



```

 return address;
 }
 else
 return null;
 } catch (SQLException ex) {
 ex.printStackTrace();
 }

 return null;
}

@WebMethod(operationName = "storeAddress")
public void storeAddress(Address address) {
 try {
 statement2.setString(1, address.getLastName());
 statement2.setString(2, address.getFirstName());
 statement2.setString(3, address.getMi());
 statement2.setString(4, address.getTelephone());
 statement2.setString(5, address.getEmail());
 statement2.setString(6, address.getStreet());
 statement2.setString(7, address.getCity());
 statement2.setString(8, address.getState());
 statement2.setString(9, address.getZip());
 statement2.executeUpdate();
 } catch (SQLException ex) {
 ex.printStackTrace();
 }
}

/** Initialize database connection */
public void initializeJdbc() {
 try {
 Class.forName("com.mysql.jdbc.Driver");

 // Connect to the sample database
 Connection connection = DriverManager.getConnection(
 "jdbc:mysql://localhost/javabook", "scott", "tiger");

 statement1 = connection.prepareStatement(
 "select * from Address where firstName = ? and lastName = ?");
 statement2 = connection.prepareStatement(
 "insert into Address " +
 "(lastName, firstName, mi, telephone, email, street, city, " +
 + "state, zip) values (?, ?, ?, ?, ?, ?, ?, ?, ?)");
 } catch (Exception ex) {
 ex.printStackTrace();
 }
}
}

```

The new Web service is named AddressWebService (line 9) for the AddressService class.

When the service is deployed, the constructor (lines 17-19) of AddressWebService is invoked to initialize a database connection and create prepared statement1 and statement2 (lines 68-85).

The `findAddress` method searches the address in the `Address` table for the specified `firstName` and `lastName`. If found, the address information is returned in an `Address` object (lines 29-38). Otherwise, the method returns `null` (line 41).

The `storeAddress` method stores the address information from the `Address` object into the database (lines 52-61).

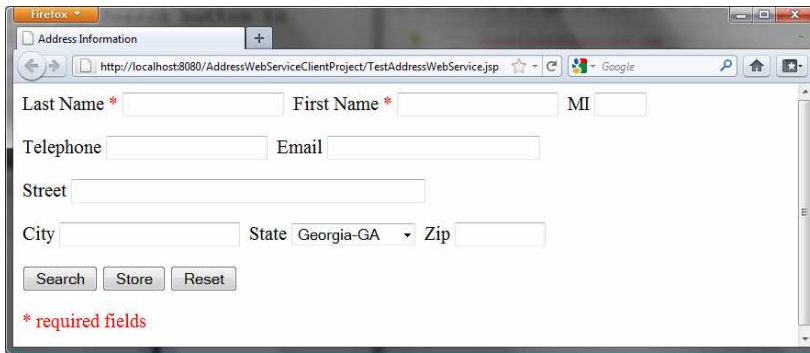
NOTE:

**<Side Remark: database driver>**

Don't forget that you have to add the MySQL library to the `WebServiceProject` for this example to run.

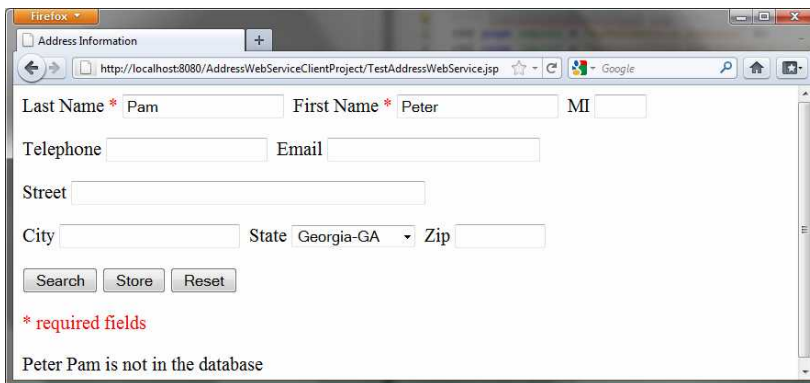
Before you can use the service, deploy it. Right-click the `WebServiceProject` node in the Project to display a context menu and choose **Deploy**.

Now you are ready to develop a Web client that uses the `AddressWebService`. The client is a JSP program, as shown in Figure 45.11. The program has two functions. First, the user can enter the last name and first name and click the `Search` button to search for a record, as shown in Figure 45.12. Second, the user can enter the complete address information and click the `Store` button to store the information to the database, as shown in Figure 45.13.



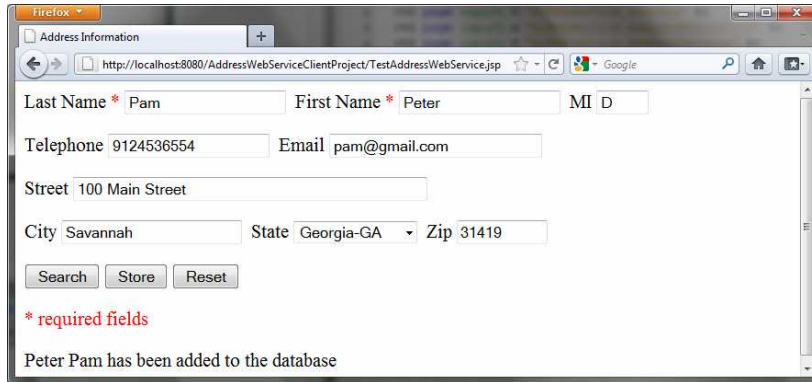
**Figure 45.11**

The `TestAddressWebService` page allows the user to search and store addresses.



**Figure 45.12**

The `Search` button finds and displays an address.



**Figure 45.13**

*The Store button stores the address to the database.*

Let us create a project for the client. The project named AddressWebServiceClientProject can be created as follows:

Choose **File > New Project** to display the New Web Application dialog box.

In the New Web Application dialog box, choose **Java Web** in the Categories pane and choose **Web Application** in the Projects pane. Click **Next** to display the Name and Location dialog box.

Enter AddressWebServiceClientProject as the project name, specify the location where you want the project to be stored, and uncheck the *Set as Main Project* check box. Click **Next** to display the Server and Settings dialog box.

Choose **GlassFish Server 3** in the Server field, and **Java EE 6 Web** as in the Java EE Version field, and click **Finish** to create the project.

**<Side Remark: Web service reference>**

You need to create a Web service reference to this project. The reference will enable you to create a proxy object to interact with the Web service. Here are the steps to create a Web service reference:

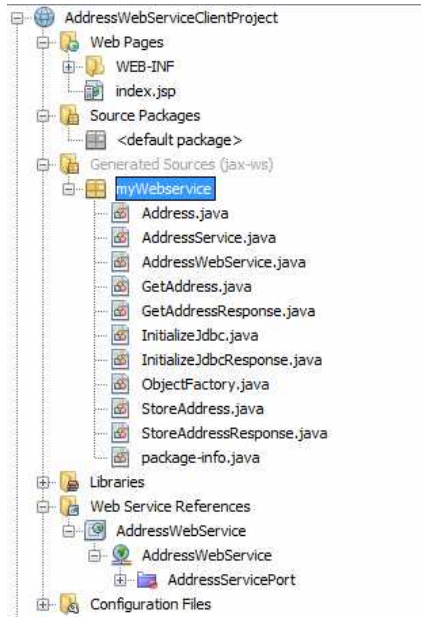
Right-click the AddressWebServiceClientProject node in the Project pane to display a context menu. Choose **New > Web Service Client** to display the New Web Service Client dialog box. Check the *WSDL URL* radio button and enter

<http://localhost:8080/WebServiceProject/AddressWebService?WSDL>

in the WSDL URL field.

3. Enter myWebservice in the package name field and choose **JAX-WS** as the JAX version. Click **Finish** to generate the Web service reference.

Now a reference to AddressWebService is created. Note that this process also copies Address.java to the client project, as shown in Figure 45.14.



**Figure 45.14**

*The Address.java is automatically copied to the Web service client reference package.*

Create a JSP named `TestAddressWebService` in the `AddressWebServiceClientProject` project, as shown in Listing 45.4.

Listing 45.4 `TestAddressWebService.jsp`

```

<Side Remark line 2: import Address>
<Side Remark line 3: import AddressWebServices>
<Side Remark line 4: import AddressServices>
<Side Remark line 14: invoke the same page>
<Side Remark line 82: create Web service>
<Side Remark line 83: get proxy object>
<Side Remark line 85: process Store button>
<Side Remark line 86: invoke remote method>
<Side Remark line 90: process Search button>
<Side Remark line 91: invoke remote method>

<!-- TestAddressWebService.jsp -->
<%@ page import = "myWebService.Address" %>
<%@ page import = "myWebService.AddressWebService" %>
<%@ page import = "myWebService.AddressService" %>
<jsp:useBean id = "addressId"
 class = "myWebService.Address" scope = "session"></jsp:useBean>
<jsp:setProperty name = "addressId" property = "*" />

<html>
<head>
 <title>Address Information</title>
</head>
<body>
 <form method = "post" action = "TestAddressWebService.jsp">

```

```

Last Name *
<input type = "text" name = "lastName"
 <%if (addressId.getLastName() != null) {
 out.print("value = \"\" + addressId.getLastName() + "\"");}%>
 size = "20" />

First Name *
<input type = "text" name = "firstName"
 <%if (addressId.getFirstName() != null) {
 out.print("value = \"\" + addressId.getFirstName() + "\"");}%>
 size = "20" />

MI
<input type = "text" name = "mi"
 <%if (addressId.getMi() != null) {
 out.print("value = \"\" + addressId.getMi() + "\" "); } %>
 size = "3" />

<p>Telephone
<input type = "text" name = "telephone"
 <%if (addressId.getTelephone() != null) {
 out.print("value = \"\" + addressId.getTelephone() + "\" ");}%>
 size = "20" />

Email
<input type = "text" name = "email"
 <%if (addressId.getEmail() != null) {
 out.print("value = \"\" + addressId.getEmail() + "\" ");}%>
 size = "28" />
</p>

<p>Street
<input type = "text" name = "street"
 <%if (addressId.getStreet() != null) {
 out.print("value = \"\" + addressId.getStreet() + "\" ");}%>
 size = "50" />
</p>

<p>City
<input type = "text" name = "city"
 <%if (addressId.getCity() != null) {
 out.print("value = \"\" + addressId.getCity() + "\" ");}%>
 size = "23" />

State
<select size = "1" name = "state">
 <option value = "GA">Georgia-GA</option>
 <option value = "OK">Oklahoma-OK</option>
 <option value = "IN">Indiana-IN</option>
</select>

Zip
<input type = "text" name = "zip"
 <%if (addressId.getZip() != null) {
 out.print("value = \"\" + addressId.getZip() + "\" "); } %>
 size = "9" />

```

```

</p>

<p><input type = "submit" name = "Submit" value = "Search">
 <input type = "submit" name = "Submit" value = "Store">
 <input type = "reset" value = "Reset">
</p>
</form>
<p>* required fields</p>

<%
if (request.getParameter("Submit") != null) {
 AddressWebService addressWebService = new AddressWebService();
 AddressService proxy = addressWebService.getAddressServicePort();

 if (request.getParameter("Submit").equals("Store")) {
 proxy.storeAddress(addressId);
 out.println(addressId.getFirstName() + " " +
 addressId.getLastName() + " has been added to the database");
 }
 else if (request.getParameter("Submit").equals("Search")) {
 Address address = proxy.getAddress(addressId.getFirstName(),
 addressId.getLastName());
 if (address == null)
 out.print(addressId.getFirstName() + " " +
 addressId.getLastName() + " is not in the database");
 else
 addressId = address;
 }
}
%>
</body>
</html>

```

Lines 2-4 import the classes for the JSP page. The `Address` class (line 2) was created in the `WebServiceProject` and was automatically copied to the `AddressWebServiceClientProjec` project when a Web service reference for `AddressWebService` was created. A JavaBeans object for `Address` was created and associated with input parameters in lines 5-7.

The UI interface was laid in the form (lines 14-77). The action for the two buttons `Search` and `Store` invokes the same page `TestAddressWebService.jsp` (line 14).

When a button is clicked, a proxy object for `AddressWebService` is obtained (lines 82-83). For the `Store` button, the proxy object invokes the `storeAddress` method to add an address to the database (line 86). For the `Search` button, the proxy object invokes the `getAddress` method to return an address (lines 91-92). If no address is found for the specified first and last names, the returned address is `null` (line 93).

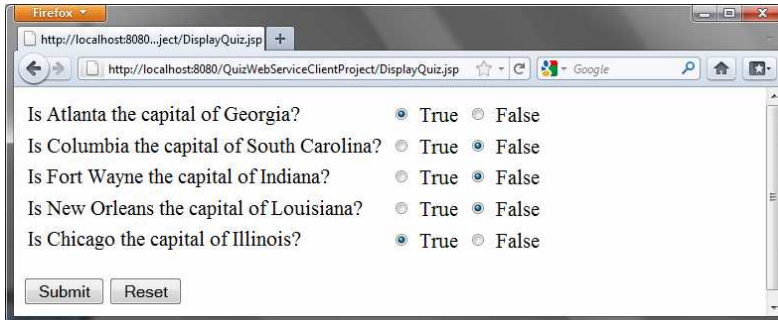
#### 45.6 Web Service Session Tracking

##### <Side Remark: [HttpSession](#)>

§42.8.3, "Session Tracking Using the Servlet API," introduced session tracking for servlets using the `javax.servlet.http.HttpSession` interface. You can use `HttpSession` to implement session tracking for Web services. To demonstrate this, consider an example that generates random True/False

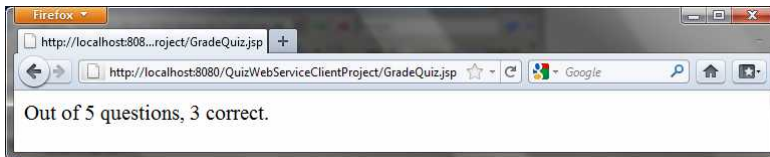
questions for the client and grades the answers on these questions for the client.

The Web client consists of two JSP pages: `DisplayQuiz.jsp` and `GradeQuiz.jsp`. The `DisplayQuiz` page invokes the service method `getQuestion()` to display the questions, as shown in Figure 45.15. When you click the `Submit` button, the program invokes the service method `gradeQuiz` to grade the answers. The result is displayed in the `GradeQuiz` page, as shown in Figure 45.16.



**Figure 45.15**

*The Submit button submits the answers for grading.*



**Figure 45.16**

*The answers are graded and displayed.*

Why is session tracking needed for this project? Each time a client displays a quiz, it creates a randomly reorder the quiz for the client. Each client gets a different quiz every time the `DisplayQuiz` page is refreshed. When the client submits the answer, the Web service checks the answer against the previously generated quiz. So the quiz has to be stored in the session.

For convenience, let us create the Web service class named `QuizService` in the `WebServiceProject` in package `chapter45`. Listing 45.5 gives the program.

Listing 45.5 `QuizService.java`

```
<Side Remark line 9: enable session tracking>
<Side Remark line 10: define service name>
<Side Remark line 12: quiz>
<Side Remark line 16: initialize quiz>
<Side Remark line 28: shuffle>
<Side Remark line 31: define service method>
<Side Remark line 32: getQuestions>
<Side Remark line 42: define service method>
<Side Remark line 43: gradeQuiz>
<Side Remark line 46: check answers>
```

```
package chapter45;

import javax.jws.WebMethod;
import javax.jws.WebService;
```

```

import java.util.List;
import java.util.ArrayList;
import com.sun.xml.ws.developer.servlet.HttpSessionScope;

@HttpSessionScope
@WebService(name = "QuizService", serviceName = "QuizWebService")
public class QuizService {
 private ArrayList<Object[]> quiz = new ArrayList<Object[]>();

 public QuizService() {
 // Initialize questions and answers
 quiz.add(new Object[]{
 "Is Atlanta the capital of Georgia?", true});
 quiz.add(new Object[]{
 "Is Columbia the capital of South Carolina?", true});
 quiz.add(new Object[]{
 "Is Fort Wayne the capital of Indiana?", false});
 quiz.add(new Object[]{
 "Is New Orleans the capital of Louisiana?", false});
 quiz.add(new Object[]{
 "Is Chicago the capital of Illinois?", false});

 // Shuffle to generate a random quiz for a client
 java.util.Collections.shuffle(quiz);
 }

 @WebMethod(operationName = "getQuestions")
 public java.util.List<String> getQuestions() {
 // Extract questions from quiz
 List<String> questions = new ArrayList<String>();
 for (int i = 0; i < quiz.size(); i++) {
 questions.add((String) (quiz.get(i)[0]));
 }

 return questions; // Return questions in the quiz
 }

 @WebMethod(operationName = "gradeQuiz")
 public List<Boolean> gradeQuiz(List<Boolean> answers) {
 List<Boolean> result = new ArrayList<Boolean>();
 for (int i = 0; i < quiz.size(); i++)
 result.add(quiz.get(i)[1] == answers.get(i));

 return result;
 }
}

```

The Web service class named `QuizService` contains two methods `getQuestions` and `gradeQuiz`. The new Web service is named `QuizWebService` (line 10).

The annotation `@HttpSessionScope` (line 9) is new in JAX-WS 2.2, which enables the Web service automatically maintains a separate instance for each client session. To use this annotation, you have to add JAX-WS 2.2 into your project's library. This can be done by clicking the **Library** node in the project and select **Add Library**.

**<Side Remark: creating a quiz>**



Assume that five True/False questions are available from the service. The quiz is stored in an `ArrayList` (lines 16-25). Each element in the list is an array with two values. The first value is a string that describes the question and the second is a Boolean value indicating whether the answer should be true or false.

**<Side Remark: randomly shuffling>**

A new quiz is generated in the constructor and the quiz is shuffled using the `shuffle` method in the `Collections` class (line 28).

**<Side Remark: getQuestions>**

The `getQuestions` method (lines 31-40) returns questions in a list. The questions are extracted from the quiz (lines 34-37) and are returned (line 39).

**<Side Remark: gradeQuiz>**

The `gradeQuiz` method (lines 42-49) checks the `answers` from the client with the answers in the quiz. The client's answers are compared with the key, and the result of the grading is stored in a list. Each element in the list is a boolean value that indicates whether the answer is correct or incorrect (lines 44-46).

**<Side Remark: create Web service client>**

After creating and publishing the Web service, let us create a project for the client. The project named `QuizWebServiceClientProject` can be created as follows:

Choose **File > New Project** to display the New Web Application dialog box.

In the New Web Application dialog box, choose **Java Web** in the Categories pane and choose **Web Application** in the Projects pane. Click **Next** to display the Name and Location dialog box.

Enter `QuizWebServiceClientProject` as the project name, specify the location where you want the project to be stored, and uncheck the **Set as Main Project** check box. Click **Next** to display the Server and Settings dialog box.

Choose **GlassFish Server 3** in the Server field, and **Java EE 6 Web** as in the Java EE Version field, and click **Finish** to create the project.

**<Side Remark: Web service reference>**

To use `QuizWebService`, you need to create a Web service client as follows:

Right-click the `QuizWebServiceClientProject` project in the Project pane to display a context menu. Choose **New > Web Service Client** to display the New Web Service Client dialog box.

Check the **WSDL URL** radio button and enter

<http://localhost:8080/WebServiceProject/QuizWebService?WSDL>

in the WSDL URL field.

Enter `myWebservice` in the Package field.

Click **Finish** to create the reference for `QuizWebService`.

Now a reference to `QuizWebService` is created. You can create a proxy object to access the remote methods in `QuizService`. Listings 45.6 and 45.7 show `DisplayQuiz.jsp` and `GradeQuiz.jsp`.

Listing 45.6 `DisplayQuiz.jsp`

**<Side Remark line 2: import QuizWebService>**

**<Side Remark line 3: import QuizServices>**

<Side Remark line 4: create QuizWebServices>  
 <Side Remark line 11: get proxy object>  
 <Side Remark line 12: get questions>  
 <Side Remark line 20: display questions>

```

<!-- DisplayQuiz.jsp -->
<%@ page import = "myWebservice.QuizWebService" %>
<%@ page import = "myWebservice.QuizService" %>
<jsp:useBean id = "quizWebService" scope = "session"
 class = "myWebservice.QuizWebService">
</jsp:useBean>

<html>
<body>
 <%
 QuizService proxy = quizWebService.getQuizServicePort();
 java.util.List<String> questions =
 (java.util.ArrayList<String>)(proxy.getQuestions());
 %>
 <form method = "post" action = "GradeQuiz.jsp">
 <table>
 <% for (int i = 0; i < questions.size(); i++) {%>
 <tr>
 <td>
 <label><%= questions.get(i) %></label>
 </td>
 <td>
 <input type = "radio" name = <%= "question" + i%>
 value = "True" /> True
 </td>
 <td>
 <input type = "radio" name = <%= "question" + i%>
 value = "False" /> False
 </td>
 </tr>
 <%}%>
 </table>
 <p><input type = "submit" name = "Submit" value = "Submit">
 <input type = "reset" value = "Reset">
 </p>
</form>
</body>
</html>

```

This page generates a quiz by invoking the `getQuestions()` in lines 12-13. The questions are displayed in a table with radio buttons (lines 16-32). Clicking *Submit* invokes `GradeQuiz.jsp`.

Listing 45.7 `GradeQuiz.jsp`

<Side Remark line 2: import QuizWebService>  
 <Side Remark line 3: import QuizServices>  
 <Side Remark line 4: create QuizWebServices>  
 <Side Remark line 11: get proxy object>  
 <Side Remark line 12: get questions>  
 <Side Remark line 15: get client's answers>  
 <Side Remark line 25: grade answers>

<Side Remark line 28: analyze result>

```
<!-- GradeQuiz.jsp -->
<%@ page import = "myWebservice.QuizWebService" %>
<%@ page import = "myWebservice.QuizService" %>
<jsp:useBean id = "quizWebService" scope = "session"
 class = "myWebservice.QuizWebService">
</jsp:useBean>

<html>
<body>
<%
QuizService proxy = quizWebService.getQuizServicePort();
java.util.List<String> quiz = proxy.getQuestions();

// Get the answer from the DisplayQuiz page
java.util.List<Boolean> answers = new java.util.ArrayList<Boolean>();
for (int i = 0; i < quiz.size(); i++) {
 String trueOrFalse = request.getParameter("question" + i);
 if (trueOrFalse.equals("True"))
 answers.add(true); // Answered true
 else if (trueOrFalse.equals("False"))
 answers.add(false); // Answered false
}

// Grade answers
java.util.List<Boolean> result = proxy.gradeQuiz(answers);

// Find the correct count
int correctCount = 0;
for (int i = 0; i < result.size(); i++) {
 if (result.get(i))
 correctCount++;
}
%>

Out of <%= result.size() %> questions, <%= correctCount %> correct.
</body>
</html>
```

This page collects the answers passed from the HTML form from the [DisplayQuiz](#) page (lines 15-21), invokes the [gradeQuiz](#) method to grade the quiz (line 25), finds the correct count (lines 28-31), and displays the result (line 35).

NOTE:

You need to answer all five questions before clicking the *Submit* button. A runtime error will occur if a radio button is not checked. You can fix this problem in Exercise 45.5.

**Key Terms**

- [@WebService](#)
- [@WebMethod](#)
- consuming a Web service
- proxy object
- publishing a Web service

- Web service
- Web service client reference
- WSDL

## Chapter Summary

1. Web services enable a Java program on one system to invoke a method in an object on another system.
2. Web services are platform and language independent. You can develop and use Web services using any language.
3. Web services run on the Web using HTTP. SOAP is a popular protocol for implementing Web services.
4. The server needs to make the service available to the client, known as *publishing a Web service*. Using a Web service from a client is known as *consuming a Web service*.
5. A client interacts with a Web service through a *proxy object*. The proxy object facilitates the communication between the client and the Web service.
6. You need to use Java annotation `@WebService` to annotate a Web service and use annotation `@WebMethod` to annotate a remote method.
7. A Web service class may have an unlimited number of remote methods.
8. After a Web service is published, you can write a client program to use it. You have to first create a Web client reference. From the reference, you create a proxy object for facilitating communication between a server and a client.
9. WSDL stands for *Web Service Description Language*. A `.wsdl` file is an XML file that describes the available Web service to the client—i.e., the remote methods, their parameters and return value types, and so on.
10. The message between the client and server is described in XML. A SOAP request describes the information that is sent to the Web service and a SOAP response describes the information that is received from the Web service.
11. The objects passed between client and Web service are serialized in XML. Not all object types are supported by SOAP.
12. You can track sessions in Web services using the `HttpSession` in the same way as in servlets.

## Test Questions

Do the test questions for this chapter online at  
[www.cs.armstrong.edu/liang/intro9e/test.html](http://www.cs.armstrong.edu/liang/intro9e/test.html).

## Review Questions

### Section 45.1

- 45.1 What is a Web service?
- 45.2 Can you invoke a Web service from a language other than Java?
- 45.3 Do Web services support callback? That is, can a Web service call a method from a client's program?
- 45.4 What is SOAP? What is it to publish a Web service? What is it to consume a Web service? What is the role of a proxy object?

### Sections 45.2-45.6

- 45.5 What is the annotation to specify a Web service? What is the annotation to specify a Web method?
- 45.6 How do you deploy a Web service in NetBeans?

- 45.7 Can you test a Web service from a client?
- 45.8 How do you create a Web service reference for a client?
- 45.9 What is WSDL? What is SOAP? What is a SOAP request? What is a SOAP response?
- 45.10 Can you pass primitive type arguments to a remote method? Can you pass any object type to a remote method? Can you pass an argument of a custom type to a remote method?
- 45.11 How do you obtain an `HttpSession` object for tracking a Web session?
- 45.12 Can you create two Web service references in one package in the same project in NetBeans?
- 45.13 What happens if you don't clone the quiz in lines 40-41 in Listing 45.5, `QuizService.java`?

### Programming Exercises

45.1\*  
*(Get a score from a database table)* Suppose that the scores are stored in the `Scores` table. The table was created as follows:

```
create table Scores (name varchar(20),
 score number, permission boolean);

insert into Scores values ('John', 90.5, 1);
insert into Scores values ('Michael', 100, 1);
insert into Scores values ('Michelle', 100, 0);
```

Revise the `findScore` method in Listing 45.1, `ScoreService.java`, to obtain a score for the specified name. Note that your program does not need the `permission` column; ignore it. The next exercise will need the `permission` column.

45.2\*  
*(Permission to find scores)* Revise the preceding exercise so that the `findScore` method returns `-1` if permission is `false`. Add a another method named `getPermission(String name)` that returns `1`, `0`, or `-1`. The method returns `1` if the student is in the `Scores` table and permission is `true`, `0` if the student is in the `Scores` table and permission is `false`, and `-1` if the student is not in the `Scores` table.

45.3\*  
*(Compute loan)* You can compute a loan payment for a loan with the specified amount, number of years, and annual interest rate. Write a Web service with two remote methods for computing monthly payment and total payment. Write a client program that prompts the user to enter loan amount, number of years, and annual interest rate.

45.4\*  
*(Web service visit count)* Write a Web service with a method named `getCount()` that returns the number of the times this method has been invoked from a client. Use a session to store the `count` variable.

45.5\*

(Quiz) The user needs to answer all five questions before clicking the *Submit* button in the Quiz application in §45.6, Web Service Session Tracking. A runtime error will occur if a radio button is not checked. Fix this problem.

*\*\*\*This is a bonus Web chapter*

## **CHAPTER 46**

### **Remote Method Invocation**

Objectives

- To explain how RMI works (§46.2).
- To describe the process of developing RMI applications (§46.3).
- To distinguish between RMI and socket-level programming (§46.4).
- To develop three-tier applications using RMI (§46.5).
- To use callbacks to develop interactive applications (§46.6).

## 46.1 Introduction

Remote Method Invocation (RMI) provides a framework for building distributed Java systems. Using RMI, a Java object on one system can invoke a method in an object on another system on the network. A *distributed Java system* can be defined as a collection of cooperative distributed objects on the network. In this chapter, you will learn how to use RMI to create useful distributed applications.

## 46.2 RMI Basics

RMI is the Java Distributed Object Model for facilitating communications among distributed objects. RMI is a higher-level API built on top of sockets. Socket-level programming allows you to pass data through sockets among computers. RMI enables you also to invoke methods in a remote object. Remote objects can be manipulated as if they were residing on the local host. The transmission of data among different machines is handled by the JVM transparently.

<Side Remark: client>

<Side Remark: server>

In many ways, RMI is an evolution of the client/server architecture. A *client* is a component that issues requests for services, and a *server* is a component that delivers the requested services. Like the client/server architecture, RMI maintains the notion of clients and servers, but the RMI approach is more flexible.

- An RMI component can act as both a client and a server, depending on the scenario in question.
- An RMI system can pass functionality from a server to a client, and vice versa. Typically a client/server system only passes data back and forth between server and client.

### 46.2.1 How Does RMI Work?

<Side Remark: local object>

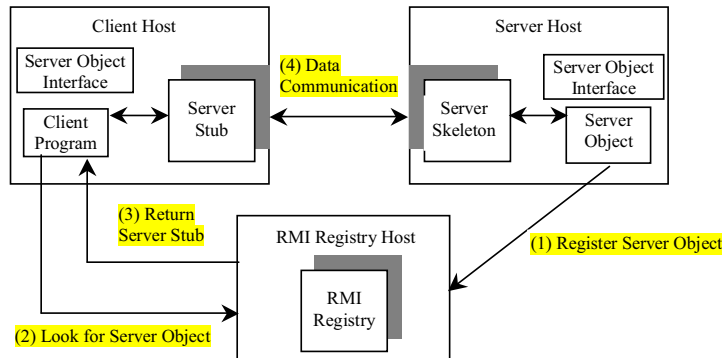
<Side Remark: remote object>

All the objects you have used before this chapter are called *local objects*. *Local objects* are accessible only within the local host. Objects that are accessible from a remote host are called *remote objects*. For an object to be invoked remotely, it must be defined in a Java interface accessible to both the server and the client. Furthermore, the interface must extend the `java.rmi.Remote` interface. Like the `java.io.Serializable` interface, `java.rmi.Remote` is a marker interface that contains no constants or methods. It is used only to identify remote objects. The key components of the RMI architecture are listed below (see Figure 46.1):

- **Server object interface:** A subinterface of `java.rmi.Remote` that defines the methods for the server object.
- **Server class:** A class that implements the remote object interface.
- **Server object:** An instance of the server class.
- **RMI registry:** A utility that registers remote objects and provides naming services for locating objects.
- **Client program:** A program that invokes the methods in the remote server object.



- **Server stub:** An object that resides on the client host and serves as a surrogate for the remote server object.
- **Server skeleton:** An object that resides on the server host and communicates with the stub and the actual server object.



**Figure 46.1**

Java RMI uses a registry to provide naming services for remote objects, and uses the stub and the skeleton to facilitate communications between client and server.

RMI works as follows:

- (1) A server object is registered with the RMI registry.
- (2) A client looks through the RMI registry for the remote object.
- (3) Once the remote object is located, its stub is returned in the client.
- (4) The remote object can be used in the same way as a local object. Communication between the client and the server is handled through the stub and the skeleton.

<Side Remark: stub>

<Side Remark: skeleton>

The implementation of the RMI architecture is complex, but the good news is that RMI provides a mechanism that liberates you from writing the tedious code for handling parameter passing and invoking remote methods. The basic idea is to use two helper classes known as the *stub* and the *skeleton* for handling communications between client and server.

The *stub* and the *skeleton* are automatically generated. The *stub* resides on the client machine. It contains all the reference information the client needs to know about the server object. When a client invokes a method on a server object, it actually invokes a method that is encapsulated in the *stub*. The *stub* is responsible for sending parameters to the server and for receiving the result from the server and returning it to the client.

The *skeleton* communicates with the *stub* on the server side. The *skeleton* receives parameters from the client, passes them to the server for execution, and returns the result to the *stub*.

#### 46.2.2 Passing Parameters

When a client invokes a remote method with parameters, passing the parameters is handled by the stub and the skeleton. Obviously, invoking methods in a remote object on a server is very different from invoking methods in a local object on a client, since the remote object is in a different address space on a separate machine. Let us consider three types of parameters:

**<Side Remark: primitive type>**

- **Primitive data types**, such as `char`, `int`, `double`, or `boolean`, are passed by value like a local call.

**<Side Remark: local object>**

- **Local object types**, such as `java.lang.String`, are also passed by value, but this is completely different from passing an object parameter in a local call. In a local call, an object parameter's reference is passed, which corresponds to the memory address of the object. In a remote call, there is no way to pass the object reference, because the address on one machine is meaningless to a different JVM. Any object can be used as a parameter in a remote call as long as it is serializable. The stub serializes the object parameter and sends it in a stream across the network. The skeleton deserializes the stream into an object.

**<Side Remark: remote object>**

- **Remote object types** are passed differently from local objects. When a client invokes a remote method with a parameter of a remote object type, the stub of the remote object is passed. The server receives the stub and manipulates the parameter through it. Passing remote objects will be discussed in §46.6, "RMI Callbacks."

### 46.2.3 RMI Registry

How does a client locate the remote object? The RMI registry provides the registry services for the server to register the object and for the client to locate the object.

You can use several overloaded static `getRegistry()` methods in the `LocateRegistry` class to return a reference to a `Registry`, as shown in Figure 46.2. Once a `Registry` is obtained, you can bind an object with a unique name in the registry using the `bind` or `rebind` method or locate an object using the lookup method, as shown in Figure 46.3.

java.rmi.registry.LocateRegistry	
<code>+getRegistry(): Registry</code>	Returns a reference to the remote object Registry for the local host on the default registry port of 1099.
<code>+getRegistry(port: int): Registry</code>	Returns a reference to the remote object Registry for the local host on the specified port.
<code>+getRegistry(host: String): Registry</code>	Returns a reference to the remote object Registry on the specified host on the default registry port of 1099.
<code>+getRegistry(host:String, port: int): Registry</code>	Returns a reference to the remote object Registry on the specified host and port.

**Figure 46.2**

The `LocateRegistry` class provides the methods for obtaining a registry on a host.

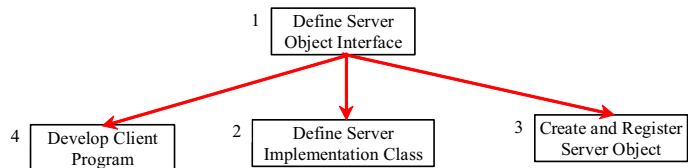
java.rmi.registry.Registry	
+bind(name: String, obj: Remote): void	Binds the specified name with the remote object.
+rebind(name: String, obj: Remote): void	Binds the specified name with the remote object. Any existing binding for the name is replaced.
+unbind(name: String): void	Destroys the binding for the specified name that is associated with a remote object.
+list(name: String): String[]	Returns an array of the names bound in the registry.
+lookup(name: String): Remote	Returns a reference, a stub, for the remote object associated with the specified name.

**Figure 46.3**

The *Registry* class provides the methods for binding and obtaining references to remote objects in a remote object registry.

### 46.3 Developing RMI Applications

Now that you have a basic understanding of RMI, you are ready to write simple RMI applications. The steps in developing an RMI application are shown in Figure 46.4 and listed below.



**Figure 46.4**

The steps in developing an RMI application.

1. Define a server object interface that serves as the contract between the server and its clients, as shown in the following outline:

```

public interface ServerInterface extends Remote {
 public void servicel(...) throws RemoteException;
 // Other methods
}

```

A server object interface must extend the `java.rmi.Remote` interface.

2. Define a class that implements the server object interface, as shown in the following outline:

```

public class ServerInterfaceImpl extends UnicastRemoteObject
 implements ServerInterface {
 public void servicel(...) throws RemoteException {
 // Implement it
 }
 // Implement other methods
}

```

The server implementation class must extend the `java.rmi.server.UnicastRemoteObject` class. The `UnicastRemoteObject` class provides support for point-to-point active object references using TCP streams.

3. Create a server object from the server implementation class and register it with an RMI registry:

```

ServerInterface server = new ServerInterfaceImpl(...);
Registry registry = LocateRegistry.getRegistry();
registry.rebind("RemoteObjectName", server);

```

4. Develop a client that locates a remote object and invokes its methods, as shown in the following outline:

```

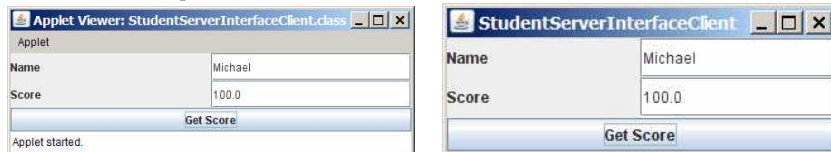
Registry registry = LocateRegistry.getRegistry(host);
ServerInterface server = (ServerInterfaceImpl)
 registry.lookup("RemoteObjectName");
server.service1(...);

```

The example that follows demonstrates the development of an RMI application through these steps.

#### 46.3.1 Example: Retrieving Student Scores from an RMI Server

This example creates a client that retrieves student scores from an RMI server. The client, shown in Figure 46.5, displays the score for the specified name.



(a) Running as applet. (b) Running as application.

**Figure 46.5**

You can get the score by entering a student name and clicking the *Get Score* button.

1. Create a server interface named `StudentServerInterface` in Listing 46.1. The interface tells the client how to invoke the server's `findScore` method to retrieve a student score.

#### Listing 46.1 StudentServerInterface.java

<Side Remark line 3: subinterface>

<Side Remark line 9: server method>

```

import java.rmi.*;

public interface StudentServerInterface extends Remote {
 /**
 * Return the score for the specified name
 * @param name the student name
 * @return a double score or -1 if the student is not found
 */
 public double findScore(String name) throws RemoteException;
}

```

Any object that can be used remotely must be defined in an interface that extends the `java.rmi.Remote` interface (line 3). `StudentServerInterface`, extending `Remote`, defines the `findScore` method that can be remotely invoked by a client to find a student's score. Each method in this interface must declare that it may throw a `java.rmi.RemoteException` (line 9). Therefore your client code that invokes this method must be prepared to catch this exception in a try-catch block.

2. Create a server implementation named `StudentServerInterfaceImpl` (Listing 46.2) that implements `StudentServerInterface`. The `findScore` method returns the score for a specified student. It returns `-1` if the score is not found.

**Listing 46.2 StudentServerInterfaceImpl.java**

<Side Remark line 8: hash map>

<Side Remark line 17: store score>

<Side Remark line 24: get score>

```
import java.rmi.*;
import java.rmi.server.*;
import java.util.*;

public class StudentServerInterfaceImpl
 extends UnicastRemoteObject
 implements StudentServerInterface {
 // Stores scores in a map indexed by name
 private HashMap<String, Double> scores =
 new HashMap<String, Double>();

 public StudentServerInterfaceImpl() throws RemoteException {
 initializeStudent();
 }

 /** Initialize student information */
 protected void initializeStudent() {
 scores.put("John", new Double(90.5));
 scores.put("Michael", new Double(100));
 scores.put("Michelle", new Double(98.5));
 }

 /** Implement the findScore method from the
 * Student interface */
 public double findScore(String name) throws RemoteException {
 Double d = (Double)scores.get(name);

 if (d == null) {
 System.out.println("Student " + name + " is not found ");
 return -1;
 }
 else {
 System.out.println("Student " + name + "'s score is "
 + d.doubleValue());
 return d.doubleValue();
 }
 }
}
```

The `StudentServerInterfaceImpl` class implements `StudentServerInterface`. This class must also extend the `java.rmi.server.RemoteServer` class or its subclass. `RemoteServer` is an abstract class that defines the methods needed to create and export remote objects. Often its subclass `java.rmi.server.UnicastRemoteObject` is used (line 6). This subclass implements all the abstract methods defined in `RemoteServer`.

`StudentServerInterfaceImpl` implements the `findScore` method (lines 25-37) defined in `StudentServerInterface`. For simplicity, three students, John, Michael, and Michelle, and their corresponding scores are stored in an instance of `java.util.HashMap` named `scores`. `HashMap` is a concrete class of the `Map` interface in the Java Collections Framework, which makes it possible to search and retrieve a value using a key. Both values and keys are of `Object` type. The `findScore` method returns the score if the name is in the hash map, and returns `-1` if the name is not found.

3. Create a server object from the server implementation and register it with the RMI server (Listing 46.3).

**Listing 46.3 RegisterWithRMIServer.java**

<Side Remark line 7: server object>

<Side Remark line 8: registry reference>

<Side Remark line 9: register>

```
import java.rmi.registry.*;

public class RegisterWithRMIServer {
 /** Main method */
 public static void main(String[] args) {
 try {
 StudentServerInterface obj =
 new StudentServerInterfaceImpl();
 Registry registry = LocateRegistry.getRegistry();
 registry.rebind("StudentServerInterfaceImpl", obj);
 System.out.println("Student server " + obj + " registered");
 }
 catch (Exception ex) {
 ex.printStackTrace();
 }
 }
}
```

`RegisterWithRMIServer` contains a main method, which is responsible for starting the server. It performs the following tasks: (1) create a server object (line 8); (2) obtain a reference to the RMI registry (line 9), and (3) register the object in the registry (line 10).

4. Create a client as an applet named `StudentServerInterfaceClient` in Listing 46.4. The client locates the server object from the RMI registry and uses it to find the scores.

**Listing 46.4 StudentServerInterfaceClient.java**

<Side Remark line 9: remote object>

<Side Remark line 11: standalone?>

<Side Remark line 19: initialize RMI>

<Side Remark line 31: register listener>

<Side Remark line 33: get score>

<Side Remark line 61: locate student>

<Side Remark line 71: main method>

<Side Remark line 74: standalone>

```
import javax.swing.*;
import java.awt.*;
import java.awt.event.*;
import java.rmi.registry.LocateRegistry;
```

```

import java.rmi.registry.Registry;

public class StudentServerInterfaceClient extends JApplet {
 // Declare a Student instance
 private StudentServerInterface student;

 private boolean isStandalone; // Is applet or application

 private JButton jbtGetScore = new JButton("Get Score");
 private JTextField jtfname = new JTextField();
 private JTextField jtfscore = new JTextField();

 public void init() {
 // Initialize RMI
 initializeRMI();

 JPanel jPanel1 = new JPanel();
 jPanel1.setLayout(new GridLayout(2, 2));
 jPanel1.add(new JLabel("Name"));
 jPanel1.add(jtfname);
 jPanel1.add(new JLabel("Score"));
 jPanel1.add(jtfscore);

 add(jbtGetScore, BorderLayout.SOUTH);
 add(jPanel1, BorderLayout.CENTER);

 jbtGetScore.addActionListener(new ActionListener() {
 public void actionPerformed(ActionEvent evt) {
 getScore();
 }
 });
 }

 private void getScore() {
 try {
 // Get student score
 double score = student.findScore(jtfname.getText().trim());

 // Display the result
 if (score < 0)
 jtfscore.setText("Not found");
 else
 jtfscore.setText(new Double(score).toString());
 }
 catch (Exception ex) {
 ex.printStackTrace();
 }
 }

 /** Initialize RMI */
 protected void initializeRMI() {
 String host = "";
 if (!isStandalone) host = getCodeBase().getHost();

 try {
 Registry registry = LocateRegistry.getRegistry(host);

```

```

 student = (StudentServerInterface)
 registry.lookup("StudentServerInterfaceImpl");
 System.out.println("Server object " + student + " found");
 }
 catch(Exception ex) {
 System.out.println(ex);
 }
}

/** Main method */
public static void main(String[] args) {
 StudentServerInterfaceClient applet =
 new StudentServerInterfaceClient();
 applet.isStandalone = true;
 JFrame frame = new JFrame();
 frame.setTitle("StudentServerInterfaceClient");
 frame.add(applet, BorderLayout.CENTER);
 frame.setSize(250, 150);
 applet.init();
 frame.setLocationRelativeTo(null);
 frame.setVisible(true);
 frame.setDefaultCloseOperation(3);
}
}

```

`StudentServerInterfaceClient` invokes the `findScore` method on the server to find the score for a specified student. The key method in `StudentServerInterfaceClient` is the `initializeRMI` method (lines 55-68), which is responsible for locating the server stub.

The `initializeRMI()` method treats standalone applications differently from applets. The host name should be the name where the applet is downloaded. It can be obtained using the `Applet`'s `getCodeBase().getHost()` (line 52). For standalone applications, the host name should be specified explicitly.

The `lookup(String name)` method (line 62) returns the remote object with the specified name. Once a remote object is found, it can be used just like a local object. The stub and the skeleton are used behind the scenes to make the remote method invocation work.

5. Follow the steps below to run this example.

5.1. Start the RMI Registry by typing **"start rmiregistry"** at a DOS prompt from the book directory. By default, the port number 1099 is used by `rmiregistry`. To use a different port number, simply type the command **"start rmiregistry portnumber"** at a DOS prompt.

5.2. Start the server `RegisterWithRMIServer` using the following command at C:\book directory:

```
C:\book>java RegisterWithRMIServer
```

5.3. Run the client `StudentServerInterfaceClient` as an application. A sample run of the application is shown in Figure 46.5(b).



5.4. Run the client `StudentServerInterfaceClient.html` from the appletviewer. A sample run is shown in Figure 46.5(a).

NOTE: You must start `rmiregistry` from the directory where you will run the RMI server, as shown in Figure 46.6. Otherwise, you will receive the error `ClassNotFoundException` on `StudentServerInterfaceImpl Stub`.

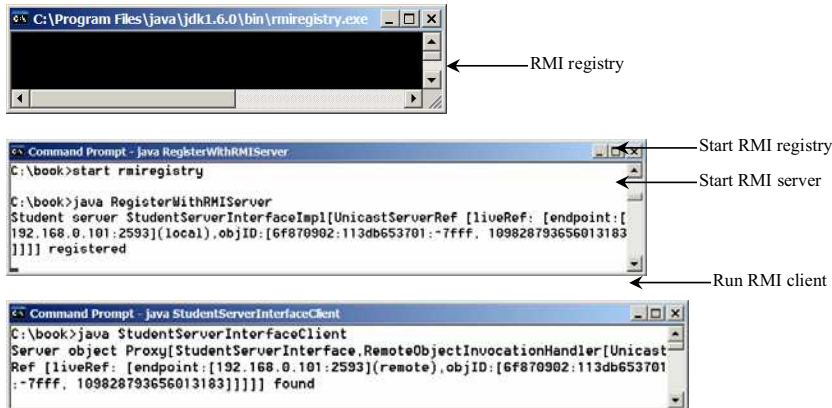


Figure 46.6

To run an RMI program, first start the `RMIRegistry`, then register the server object with the registry. The client locates it from the registry.

NOTE: Server, registry, and client can be on three different machines. If you run the client and the server on separate machines, you need to place `StudentServerInterface` on both machines. If you deploy the client as an applet, place all client files on the registry host.

CAUTION: If you modify the remote object implementation class, you need to restart the server class to reload the object to the RMI registry. In some old versions of `rmiregistry`, you may have to restart `rmiregistry`.

#### 46.4 RMI vs. Socket-Level Programming

RMI enables you to program at a higher level of abstraction. It hides the details of socket server, socket, connection, and sending or receiving data. It even implements a multithreading server under the hood, whereas with socket-level programming you have to explicitly implement threads for handling multiple clients.

RMI applications are scalable and easy to maintain. You can change the RMI server or move it to another machine without modifying the client program except for resetting the URL to locate the server. (To avoid resetting the URL, you can modify the client to pass the URL as a command-line parameter.) In socket-level programming, a client operation to send data requires a server operation to read it. The implementation of client and server at the socket level is tightly synchronized.

RMI clients can directly invoke the server method, whereas socket-level programming is limited to passing values. Socket-level programming is very primitive. Avoid using it to develop client/server applications. As an analogy, socket-level programming is like programming in assembly language, while RMI programming is like programming in a high-level language.

#### 46.5 Developing Three-Tier Applications Using RMI

Three-tier applications have gained considerable attention in recent years, largely because of the demand for more scalable and load-balanced systems to replace traditional two-tier client/server database systems. A centralized database system does not just handle data access, it also processes the business rules on data. Thus, a centralized database is usually heavily loaded, because it requires extensive data manipulation and processing. In some situations, data processing is handled by the client and business rules are stored on the client side. It is preferable to use a middle tier as a buffer between client and database. The middle tier can be used to apply business logic and rules, and to process data to reduce the load on the database.

A three-tier architecture does more than just reduce the processing load on the server. It also provides access to multiple network sites. This is especially useful to Java applets that need to access multiple databases on different servers, since an applet can connect only with the server from which it is downloaded.

To demonstrate, let us rewrite the example in §46.3.1, "Example: Retrieving Student Scores from an RMI Server," to find scores stored in a database rather than a hash map. In addition, the system is capable of blocking a client from accessing a student who has not given the university permission to publish his/her score. An RMI component is developed to serve as a middle tier between client and database; it sends a search request to the database, processes the result, and returns an appropriate value to the client.

For simplicity, this example reuses the `StudentServerInterface` interface and `StudentServerInterfaceClient` class from §46.3.1 with no modifications. All you have to do is to provide a new implementation for the server interface and create a program to register the server with the RMI. Here are the steps to complete the program:

1. Store the scores in a database table named `Score` that contains three columns: `name`, `score`, and `permission`. The permission value is `1` or `0`, which indicates whether the student has given the university permission to release his/her grade. The following is the statement to create the table and insert three records:

```
create table Scores (name varchar(20),
 score number, permission number);

insert into Scores values ('John', 90.5, 1);
insert into Scores values ('Michael', 100, 1);
insert into Scores values ('Michelle', 100, 0);
```

2. Create a new server implementation named `Student3TierImpl` in Listing 46.5. The server retrieves a record from the `Scores` table, processes the retrieved information, and sends the result back to the client.

**Listing 46.5 Student3TierImpl.java**

```

<Side Remark line 14: initialize db>
<Side Remark line 31: load driver>
<Side Remark line 39: connect db>
<Side Remark line 43: prepare statement>
<Side Remark line 58: set name>
<Side Remark line 61: execute SQL>
<Side Remark line 66: get score>
import java.rmi.*;
import java.rmi.server.*;
import java.sql.*;

public class Student3TierImpl extends UnicastRemoteObject
 implements StudentServerInterface {
 // Use prepared statement for querying DB
 private PreparedStatement pstmt;

 /** Constructs Student3TierImpl object and exports it on
 * default port.
 */
 public Student3TierImpl() throws RemoteException {
 initializeDB();
 }

 /** Constructs Student3TierImpl object and exports it on
 * specified port.
 * @param port The port for exporting
 */
 public Student3TierImpl(int port) throws RemoteException {
 super(port);
 initializeDB();
 }

 /** Load JDBC driver, establish connection and
 * create statement */
 protected void initializeDB() {
 try {
 // Load the JDBC driver
 // Class.forName("oracle.jdbc.driver.OracleDriver");
 Class.forName("com.mysql.jdbc.Driver");

 System.out.println("Driver registered");

 // Establish connection
 /*Connection conn = DriverManager.getConnection
 ("jdbc:oracle:thin:@drake.armstrong.edu:1521:orcl",
 "scott", "tiger"); */
 Connection conn = DriverManager.getConnection
 ("jdbc:mysql://localhost/javabook", "scott", "tiger");
 System.out.println("Database connected");

 // Create a prepared statement for querying DB
 pstmt = conn.prepareStatement(
 "select * from Scores where name = ?");

```

```

 }
 catch (Exception ex) {
 System.out.println(ex);
 }
}

/** Return the score for specified the name
 * Return -1 if score is not found.
 */
public double findScore(String name) throws RemoteException {
 double score = -1;
 try {
 // Set the specified name in the prepared statement
 pstmt.setString(1, name);

 // Execute the prepared statement
 ResultSet rs = pstmt.executeQuery();

 // Retrieve the score
 if (rs.next()) {
 if (rs.getBoolean(3))
 score = rs.getDouble(2);
 }
 }
 catch (SQLException ex) {
 System.out.println(ex);
 }

 System.out.println(name + "'s score is " + score);
 return score;
}
}

```

`Student3TierImpl` is similar to `StudentServerInterfaceImpl` in §46.3.1 except that the `Student3TierImpl` class finds the score from a JDBC data source instead from a hash map.

The table named `Scores` consists of three columns, `name`, `score`, and `permission`, where the latter indicates whether the student has given permission to show his/her score. Since SQL does not support a `boolean` type, `permission` is defined as a number whose value of `1` indicates `true` and of `0` indicates `false`.

The `initializeDB()` method (lines 28-42) establishes connections with the database and creates a prepared statement for processing the query.

The `findScore` method (lines 47-68) sets the name in the prepared statement, executes the statement, processes the result, and returns the score for a student whose `permission` is `true`.

- Write a `main` method in the class `RegisterStudent3TierServer` (Listing 46.6) that registers the server object using `StudentServerInterfaceImpl`, the same name as in Listing 46.2, so that you can use `StudentServerInterfaceClient`, created in §46.3.1, to test the server.

#### Listing 46.6 RegisterStudent3TierServer.java

<Side Remark line 7: registry on localhost>

<Side Remark line 8: register server object>

```
import java.rmi.registry.*;

public class RegisterStudent3TierServer {
 public static void main(String[] args) {
 try {
 StudentServerInterface obj = new Student3TierImpl();
 Registry registry = LocateRegistry.getRegistry();
 registry.rebind("StudentServerInterfaceImpl", obj);
 System.out.println("Student server " + obj + " registered");
 } catch (Exception ex) {
 ex.printStackTrace();
 }
 }
}
```

4. Follow the steps below to run this example.

4.1. Start RMI Registry by typing "**start rmiregistry**" at a DOS prompt from the book directory.

4.2. Start the server `RegisterStudent3TierServer` using the following command at the C:\book directory:

```
C:\book>java RegisterStudent3TierServer
```

4.3. Run the client `StudentServerInterfaceClient` as an application or applet. A sample run is shown in Figure 46.6.

#### 46.6 RMI Callbacks

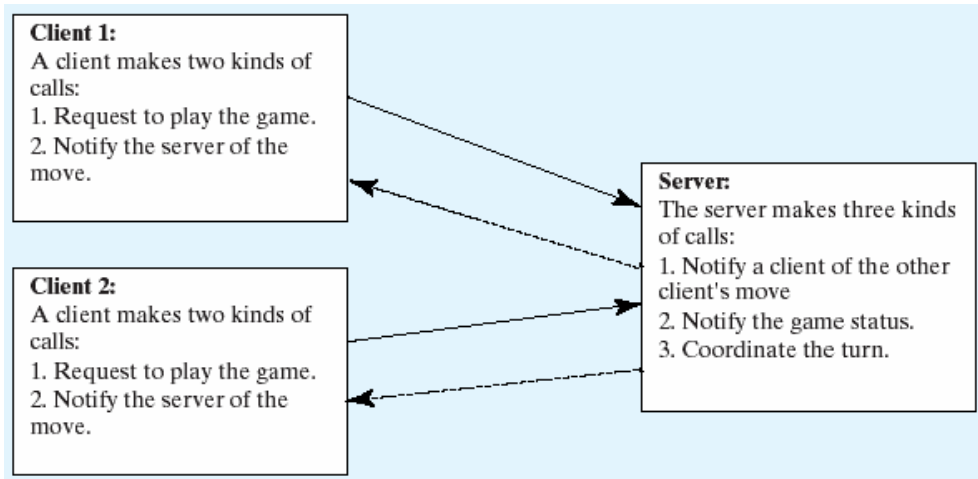
In a traditional client/server system, a client sends a request to a server, and the server processes the request and returns the result to the client. The server cannot invoke the methods on a client. One important benefit of RMI is that it supports *callbacks*, which enable the server to invoke methods on the client. With the RMI callback feature, you can develop interactive distributed applications.

In §30.9, "Case Studies: Distributed TicTacToe Games," you developed a distributed TicTacToe game using stream socket programming. The example that follows demonstrates the use of the RMI callback feature to develop an interactive TicTacToe game.

All the examples you have seen so far in this chapter have simple behaviors that are easy to model with classes. The behavior of the TicTacToe game is somewhat complex. To create the classes to model the game, you need to study and understand it and distribute the process appropriately between client and server.

Clearly the client should be responsible for handling user interactions, and the server should coordinate with the client. Specifically, the client should register with the server, and the server can take two and only two players. Once a client makes a move, it should notify the server; the server then notifies the move to the other player. The server should determine the status of the game—that is, whether it has been won or drawn—and notify the players. The server should also coordinate the turns—that is, which client has the turn at a given time. The ideal approach for

notifying a player is to invoke a method in the client that sets appropriate properties in the client or sends messages to a player. Figure 46.7 illustrates the relationship between clients and server.



**Figure 46.7**

*The server coordinates the activities with the clients.*

All the calls a client makes can be encapsulated in one remote interface named `TicTacToe` (Listing 46.7), and all the calls the server invokes can be defined in another interface named `CallBack` (Listing 46.8). These two interfaces are defined as follows:

**Listing 46.7 TicTacToeInterface.java**

<Side Remark line 3: subinterface>  
 <Side Remark line 9: server method>  
 <Side Remark line 12: server method>

```

import java.rmi.*;

public interface TicTacToeInterface extends Remote {
 /**
 * Connect to the TicTacToe server and return the token.
 * If the returned token is ' ', the client is not connected to
 * the server
 */
 public char connect(CallBack client) throws RemoteException;

 /** A client invokes this method to notify the server of its move*/
 public void myMove(int row, int column, char token)
 throws RemoteException;
}

```

**Listing 46.8 CallBack.java**

<Side Remark line 3: subinterface>  
 <Side Remark line 5: server method>  
 <Side Remark line 8: server method>  
 <Side Remark line 12: server method>

```

import java.rmi.*;

```

```

public interface Callback extends Remote {
 /** The server notifies the client for taking a turn */
 public void takeTurn(boolean turn) throws RemoteException;

 /** The server sends a message to be displayed by the client */
 public void notify(java.lang.String message)
 throws RemoteException;

 /** The server notifies a client of the other player's move */
 public void mark(int row, int column, char token)
 throws RemoteException;
}

```

What does a client need to do? The client interacts with the player. Assume that all the cells are initially empty, and that the first player takes the X token and the second player the O token. To mark a cell, the player points the mouse to the cell and clicks it. If the cell is empty, the token (X or O) is displayed. If the cell is already filled, the player's action is ignored.

From the preceding description, it is obvious that a cell is a GUI object that handles mouse-click events and displays tokens. The candidate for such an object could be a button or a panel. Panels are more flexible than buttons. The token (X or O) can be drawn on a panel in any size, but it can be displayed only as a label on a button.

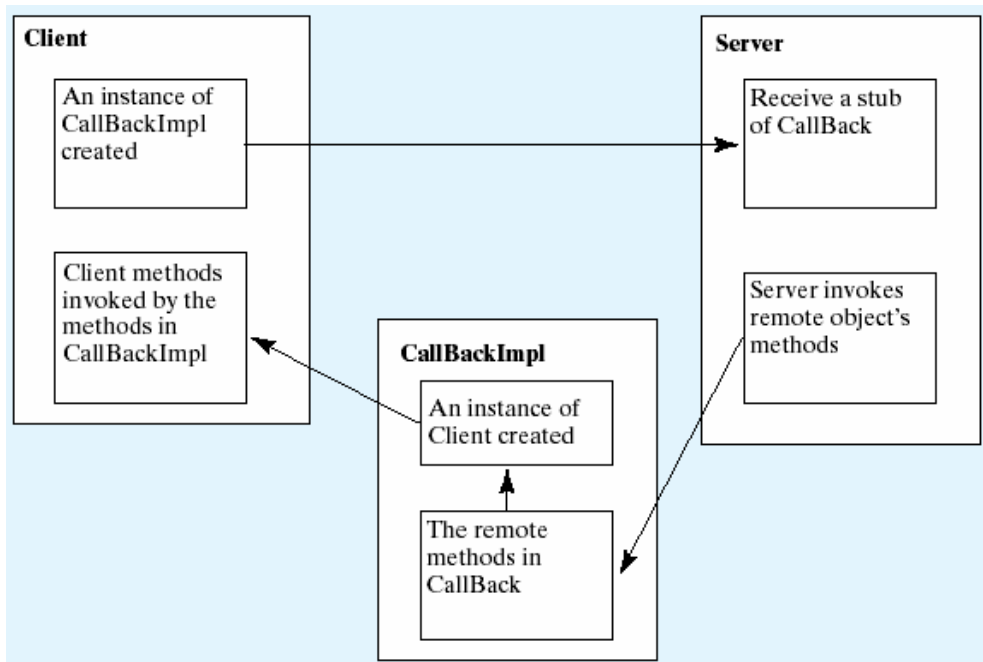
Let Cell be a subclass of JPanel. You can declare a  $3 \times 3$  grid to be an array Cell[][] cell = new Cell[3][3] for modeling the game. How do you know the state of a cell (marked or not)? You can use a property named marked of the boolean type in the Cell class. How do you know whether the player has a turn? You can use a property named myTurn of boolean. This property (initially false) can be set by the server through a callback.

The Cell class is responsible for drawing the token when an empty cell is clicked, so you need to write the code for listening to the MouseEvent and for painting the shape for tokens X and O. To determine which shape to draw, introduce a variable named marker of the char type. Since this variable is shared by all the cells in a client, it is preferable to declare it in the client and to declare the Cell class as an inner class of the client so that this variable will be accessible to all the cells.

Now let us turn our attention to the server side. What does the server need to do? The server needs to implement TicTacToeInterface and notify the clients of the game status. The server has to record the moves in the cells and check the status every time a player makes a move. The status information can be kept in a  $3 \times 3$  array of char. You can implement a method named isFull() to check whether the board is full and a method named isWon(token) to check whether a specific player has won.

Once a client is connected to the server, the server notifies the client which token to use—that is, X for the first client and O for the second. Once a client notifies the server of its move, the server checks the game status and notifies the clients.

Now the most critical question is how the server notifies a client. You know that a client invokes a server method by creating a server stub on the client side. A server cannot directly invoke a client, because the client is not declared as a remote object. The `CallBack` interface was created to facilitate the server's callback to the client. In the implementation of `CallBack`, an instance of the client is passed as a parameter in the constructor of `CallBack`. The client creates an instance of `CallBack` and passes its stub to the server, using a remote method named `connect()` defined in the server. The server then invokes the client's method through a `CallBack` instance. The triangular relationship of client, `CallBack` implementation, and server is shown in Figure 46.8.



**Figure 46.8**

The server receives a `CallBack` stub from the client and invokes the remote methods defined in the `CallBack` interface, which can invoke the methods defined in the client.

Here are the steps to complete the example.

1. Create `TicTacToeImpl.java` (Listing 46.9) to implement `TicTacToeInterface`. Add a main method in the program to register the server with the RMI.

**Listing 46.9 TicTacToeImpl.java**

```

<Side Remark line 9: call back objects>
<Side Remark line 34: implement connect>
<Side Remark line 58: implement myMove>
<Side Remark line 101: isWon>
<Side Remark line 124: isFull>
<Side Remark line 137: register object>
import java.rmi.*;

```



```

import java.rmi.server.*;
import java.rmi.registry.*;
import java.rmi.registry.*;

public class TicTacToeImpl extends UnicastRemoteObject
 implements TicTacToeInterface {
 // Declare two players, used to call players back
 private Callback player1 = null;
 private Callback player2 = null;

 // board records players' moves
 private char[][] board = new char[3][3];

 /** Constructs TicTacToeImpl object and exports it on default port.
 */
 public TicTacToeImpl() throws RemoteException {
 super();
 }

 /** Constructs TicTacToeImpl object and exports it on specified
 * port.
 * @param port The port for exporting
 */
 public TicTacToeImpl(int port) throws RemoteException {
 super(port);
 }

 /**
 * Connect to the TicTacToe server and return the token.
 * If the returned token is ' ', the client is not connected to
 * the server
 */
 public char connect(Callback client) throws RemoteException {
 if (player1 == null) {
 // player1 (first player) registered
 player1 = client;
 player1.notify("Wait for a second player to join");
 return 'X';
 }
 else if (player2 == null) {
 // player2 (second player) registered
 player2 = client;
 player2.notify("Wait for the first player to move");
 player2.takeTurn(false);
 player1.notify("It is my turn (X token)");
 player1.takeTurn(true);
 return 'O';
 }
 else {
 // Already two players
 client.notify("Two players are already in the game");
 return ' ';
 }
 }

 /** A client invokes this method to notify the server of its move*/
 public void myMove(int row, int column, char token)
 throws RemoteException {
 // Set token to the specified cell

```

```

board[row][column] = token;

// Notify the other player of the move
if (token == 'X')
 player2.mark(row, column, 'X');
else
 player1.mark(row, column, 'O');

// Check if the player with this token wins
if (isWon(token)) {
 if (token == 'X') {
 player1.notify("I won!");
 player2.notify("I lost!");
 player1.takeTurn(false);
 }
 else {
 player2.notify("I won!");
 player1.notify("I lost!");
 player2.takeTurn(false);
 }
}
else if (isFull()) {
 player1.notify("Draw!");
 player2.notify("Draw!");
}
else if (token == 'X') {
 player1.notify("Wait for the second player to move");
 player1.takeTurn(false);
 player2.notify("It is my turn, (O token)");
 player2.takeTurn(true);
}
else if (token == 'O') {
 player2.notify("Wait for the first player to move");
 player2.takeTurn(false);
 player1.notify("It is my turn, (X token)");
 player1.takeTurn(true);
}
}

/** Check if a player with the specified token wins */
public boolean isWon(char token) {
 for (int i = 0; i < 3; i++)
 if ((board[i][0] == token) && (board[i][1] == token)
 && (board[i][2] == token))
 return true;

 for (int j = 0; j < 3; j++)
 if ((board[0][j] == token) && (board[1][j] == token)
 && (board[2][j] == token))
 return true;

 if ((board[0][0] == token) && (board[1][1] == token)
 && (board[2][2] == token))
 return true;

 if ((board[0][2] == token) && (board[1][1] == token)
 && (board[2][0] == token))
 return true;
}

```

```

 return false;
}

/** Check if the board is full */
public boolean isFull() {
 for (int i = 0; i < 3; i++)
 for (int j = 0; j < 3; j++)
 if (board[i][j] == '\u0000')
 return false;

 return true;
}

public static void main(String[] args) {
 try {
 TicTacToeInterface obj = new TicTacToeImpl();
 Registry registry = LocateRegistry.getRegistry();
 registry.rebind("TicTacToeImpl", obj);
 System.out.println("Server " + obj + " registered");
 }
 catch (Exception ex) {
 ex.printStackTrace();
 }
}
}

```

2. Create `CallBackImpl.java` (Listing 46.10) to implement the `CallBack` interface.

**Listing 46.10 CallBackImpl.java**

<Side Remark line 15: implement>  
 <Side Remark line 20: implement>  
 <Side Remark line 25: implement>

```

import java.rmi.*;
import java.rmi.server.*;

public class CallBackImpl extends UnicastRemoteObject
 implements CallBack {
 // The client will be called by the server through callback
 private TicTacToeClientRMI thisClient;

 /** Constructor */
 public CallBackImpl(Object client) throws RemoteException {
 thisClient = (TicTacToeClientRMI)client;
 }

 /** The server notifies the client for taking a turn */
 public void takeTurn(boolean turn) throws RemoteException {
 thisClient.setMyTurn(turn);
 }

 /** The server sends a message to be displayed by the client */
 public void notify(String message) throws RemoteException {
 thisClient.setMessage(message);
 }

 /** The server notifies a client of the other player's move */

```

```

public void mark(int row, int column, char token)
 throws RemoteException {
 thisClient.mark(row, column, token);
}
}

```

3. Create an applet `TicTacToeClientRMI` (Listing 46.11) for interacting with a player and communicating with the server. Enable it to run standalone.

**Listing 46.11 TicTacToeClientRMI.java**

*<Side Remark line 20: server object>*  
*<Side Remark line 33: create UI>*  
*<Side Remark line 58: registry host>*  
*<Side Remark line 62: server object>*  
*<Side Remark line 70: call back>*  
*<Side Remark line 115: register listener>*  
*<Side Remark line 165: standalone>*

```

import java.rmi.*;
import java.awt.*;
import java.awt.event.*;
import javax.swing.*;
import javax.swing.border.*;
import java.rmi.registry.Registry;
import java.rmi.registry.LocateRegistry;

public class TicTacToeClientRMI extends JApplet {
 // marker is used to indicate the token type
 private char marker;

 // myTurn indicates whether the player can move now
 private boolean myTurn = false;

 // Each cell can be empty or marked as 'O' or 'X'
 private Cell[][] cell;

 // ticTacToe is the game server for coordinating with the players
 private TicTacToeInterface ticTacToe;

 // Border for cells and panel
 private Border lineBorder =
 BorderFactory.createLineBorder(Color.yellow, 1);

 private JLabel jlblStatus = new JLabel("jLabel1");
 private JLabel jlblIdentification = new JLabel();

 boolean isStandalone = false;

 /** Initialize the applet */
 public void init() {
 JPanel jPanel1 = new JPanel();
 jPanel1.setBorder(lineBorder);
 jPanel1.setLayout(new GridLayout(3, 3, 1, 1));

 add(jlblStatus, BorderLayout.SOUTH);
 add(jPanel1, BorderLayout.CENTER);
 add(jlblIdentification, BorderLayout.NORTH);
 }
}

```

```

 // Create cells and place cells in the panel
 cell = new Cell[3][3];
 for (int i = 0; i < 3; i++)
 for (int j = 0; j < 3; j++)
 jPanel1.add(cell[i][j] = new Cell(i, j));

 try {
 initializeRMI();
 }
 catch (Exception ex) {
 ex.printStackTrace();
 }
}

/** Initialize RMI */
protected boolean initializeRMI() throws Exception {
 String host = "";
 if (!isStandalone) host = getCodeBase().getHost();

 try {
 Registry registry = LocateRegistry.getRegistry(host);
 ticTacToe = (TicTacToeInterface) registry.lookup("TicTacToeImpl");
 System.out.println("Server object " + ticTacToe + " found");
 }
 catch (Exception ex) {
 System.out.println(ex);
 }
}

// Create callback for use by the server to control the client
CallBackImpl callBackControl = new CallBackImpl(this);

if (
 (marker = ticTacToe.connect((CallBack)callBackControl)) != ' ')
{
 System.out.println("connected as " + marker + " player.");
 jLabel1Identification.setText("You are player " + marker);
 return true;
}
else {
 System.out.println("already two players connected as ");
 return false;
}
}

/** Set variable myTurn to true or false */
public void setMyTurn(boolean myTurn) {
 this.myTurn = myTurn;
}

/** Set message on the status label */
public void setMessage(String message) {
 jLabel1Status.setText(message);
}

/** Mark the specified cell using the token */
public void mark(int row, int column, char token) {
 cell[row][column].setToken(token);
}

```

```

 }

 /** Inner class Cell for modeling a cell on the TicTacToe board */
 private class Cell extends JPanel {
 // marked indicates whether the cell has been used
 private boolean marked = false;

 // row and column indicate where the cell appears on the board
 int row, column;

 // The token for the cell
 private char token;

 /** Construct a cell */
 public Cell(final int row, final int column) {
 this.row = row;
 this.column = column;
 addMouseListener(new MouseAdapter() {
 public void mouseClicked(MouseEvent e) {
 if (myTurn && !marked) {
 // Mark the cell
 setToken(marker);

 // Notify the server of the move
 try {
 ticTacToe.myMove(row, column, marker);
 }
 catch (RemoteException ex) {
 System.out.println(ex);
 }
 }
 }
 });

 setBorder(lineBorder);
 }

 /** Set token on a cell (mark a cell) */
 public void setToken(char c) {
 token = c;
 marked = true;
 repaint();
 }

 /** Paint the cell to draw a shape for the token */
 protected void paintComponent(Graphics g) {
 super.paintComponent(g);

 // Draw the border
 g.drawRect(0, 0, getSize().width, getSize().height);

 if (token == 'X') {
 g.drawLine(10, 10, getSize().width - 10,
 getSize().height - 10);
 g.drawLine(getSize().width - 10, 10, 10,
 getSize().height - 10);
 }
 else if (token == 'O') {
 g.drawOval(10, 10, getSize().width - 20,

```

```

 }
 }
}

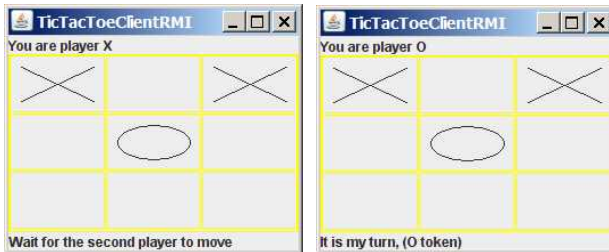
/** Main method */
public static void main(String[] args) {
 TicTacToeClientRMI applet = new TicTacToeClientRMI();
 applet.isStandalone = true;
 applet.init();
 applet.start();
 JFrame frame = new JFrame();
 frame.setDefaultCloseOperation(JFrame.EXIT_ON_CLOSE);
 frame.setTitle("TicTacToeClientRMI");
 frame.add(applet, BorderLayout.CENTER);
 frame.setSize(400, 320);
 frame.setVisible(true);
}
}
}

```

4. Follow the steps below to run this example.
  - 4.1. Start RMI Registry by typing **"start rmiregistry"** at a DOS prompt from the book directory.
  - 4.2. Start the server TicTacToeImpl using the following command at the C:\book directory:

**C:\book>java TicTacToeImpl**

Run the client TicTacToeClientRMI as an application or an applet. A sample run is shown in Figure 46.9.



**Figure 46.9**

*Two players play each other through the RMI server.*

TicTacToeInterface defines two remote methods, connect(CallBack client) and myMove(int row, int column, char token). The connect method plays two roles: one is to pass a CallBack stub to the server, and the other is to let the server assign a token for the player. The myMove method notifies the server that the player has made a specific move.

The CallBack interface defines three remote methods, takeTurn(boolean turn), notify(String message), and mark(int row, int column, char token). The takeTurn method sets the client's myTurn property to true or false. The notify method displays a message on the client's status label. The mark method marks the client's cell with the token at the specified location.

TicTacToeImpl is a server implementation for coordinating with the clients and managing the game. The variables player1 and player2 are instances of CallBack, each of which corresponds to a client, passed from a client when the client invokes the connect method. The variable board records the moves by the two players. This information is needed to determine the game status. When a client invokes the connect method, the server assigns a token X for the first player and O for the second player, and accepts only two players. You can modify the program to accept additional clients as observers. See Exercise 46.7 for more details.

Once two players are in the game, the server coordinates the turns between them. When a client invokes the myMove method, the server records the move and notifies the other player by marking the other player's cell. It then checks to see whether the player wins or whether the board is full. If neither condition applies and therefore the game continues, the server gives a turn to the other player.

The CallBackImpl implements the CallBack interface. It creates an instance of TicTacToeClientRMI through its constructor. The CallBackImpl relays the server request to the client by invoking the client's methods. When the server invokes the takeTurn method, CallBackImpl invokes the client's setMyTurn() method to set the property myTurn in the client. When the server invokes the notify() method, CallBackImpl invokes the client's setMessage() method to set the message on the client's status label. When the server invokes the mark method, CallBackImpl invokes the client's mark method to mark the specified cell.

TicTacToeClientRMI can run as a standalone application or as an applet. The initializeRMI method is responsible for creating the URL for running as a standalone application or as an applet, for locating the TicTacToeImpl server stub, for creating the CallBack server object, and for connecting the client with the server.

Interestingly, obtaining the TicTacToeImpl stub for the client is different from obtaining the CallBack stub for the server. The TicTacToeImpl stub is obtained by invoking the lookup() method through the RMI registry, and the CallBack stub is passed to the server through the connect method in the TicTacToeImpl stub. It is a common practice to obtain the first stub with the lookup method, but to pass the subsequent stubs as parameters through remote method invocations.

Since the variables myTurn and marker are defined in TicTacToeClientRMI, the Cell class is defined as an inner class within TicTacToeClientRMI in order to enable all the cells in the client to access them. Exercise 46.8 suggests alternative approaches that implement the Cell as a noninner class.

## Key Terms

- callback
- RMI registry
- skeleton
- stub



## Chapter Summary

1. RMI is a high-level Java API for building distributed applications using distributed objects.
2. The key idea of RMI is its use of stubs and skeletons to facilitate communications between objects. The stub and skeleton are automatically generated, which relieves programmers of tedious socket-level network programming.
3. For an object to be used remotely, it must be defined in an interface that extends the `java.rmi.Remote` interface.
4. In an RMI application, the initial remote object must be registered with the RMI registry on the server side and be obtained using the `lookup` method through the registry on the client side. Subsequent uses of stubs of other remote objects may be passed as parameters through remote method invocations.
5. RMI is especially useful for developing scalable and load-balanced multitier distributed applications.

## Test Questions

Do the test questions for this chapter online at [www.cs.armstrong.edu/liang/intro9e/test.html](http://www.cs.armstrong.edu/liang/intro9e/test.html).

## Review Questions

### Sections 46.2-46.3

- 46.1 How do you define an interface for a remote object?
- 46.2 Describe the roles of the stub and the skeleton.
- 46.3 What is `java.rmi.Remote`? How do you define a server class?
- 46.4 What is an RMI registry for? How do you create an RMI registry?
- 46.5 What is the command to start an RMI Registry?
- 46.6 How do you register a remote object with the RMI registry?
- 46.7 What is the command to start a custom RMI server?
- 46.8 How does a client locate a remote object stub through an RMI registry?
- 46.9 How do you obtain a registry? How do you register a remote object? How do you locate remote object?

### Sections 46.4-46.6

- 46.10 What are the advantages of RMI over socket-level programming?
- 46.11 Describe how parameters are passed in RMI.
- 46.12 What is the problem if the `connect` method in the `TicTacToeInterface` is defined as

```
public boolean connect(CallBack client, char token)
 throws RemoteException;
```

or as

```
public boolean connect(CallBack client, Character token)
 throws RemoteException;
```

- 46.13 What is callback? How does callback work in RMI?

## Programming Exercises

### Section 46.3

- 46.1\*

(*Limit the number of clients*) Modify the example in §46.3.1, “Example: Retrieving Student Scores from an RMI Server,” to limit the number of concurrent clients to ten.

46.2\*

(*Compute loan*) Rewrite Exercise 30.1 using RMI. You need to define a remote interface for computing monthly payment and total payment.

46.3\*\*

(*Web visit count*) Rewrite Exercise 30.4 using RMI. You need to define a remote interface for obtaining and increasing the count.

46.4\*\*

(*Display and add addresses*) Rewrite Exercise 34.6 using RMI. You need to define a remote interface for adding addresses and retrieving address information.

### Section 46.5

46.5\*\*

(*Address in a database table*) Rewrite Exercise 46.4. Assume that the address is stored in a table.

46.6\*\*

(*Three-tier application*) Use the three-tier approach to modify Exercise 46.4, as follows:

- Create an applet client to manipulate student information, as shown in Figure 30.23(a).
- Create a remote object interface with methods for retrieving, inserting, and updating student information, and an object implementation for the interface.

### Section 46.6

46.7\*\*

(*Chat*) Rewrite Exercise 30.13 using RMI. You need to define a remote interface for sending and receiving a message.

46.8\*\*

(*Improve TicTacToe*) Modify the TicTacToe example in §46.6, “RMI Callbacks,” as follows:

- Allow a client to connect to the server as an observer to watch the game.
- Rewrite the Cell class as a noninner class.

*\*\*\*This is a bonus Web chapter*

## CHAPTER 47

### 2-4 Trees and B-Trees

#### Objectives

- To know what a 2-4 tree is (§47.1).
- To design the `Tree24` class that implements the `Tree` interface (§47.2).
- To search an element in a 2-4 tree (§47.3).
- To insert an element in a 2-4 tree and know how to split a node (§47.4).
- To delete an element from a 2-4 tree and know how to perform transfer and fusion operations (§47.5).
- To traverse elements in a 2-4 tree (§47.6).
- To implement and test the `Tree24` class (§§47.7-47.8).
- To analyze the complexity of the 2-4 tree (§47.9).
- To use B-trees for indexing large amount of data (§47.10).

47.1 Introduction

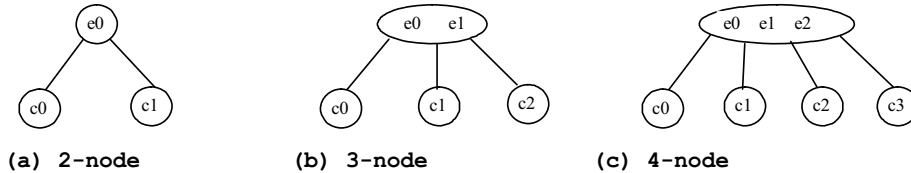
<margin note: completely balanced tree>

<margin note: 2-node>

<margin note: 3-node>

<margin note: 4-node>

A 2-4 tree, also known as a 2-3-4 tree, is a *completely balanced* search tree with all leaf nodes appearing on the same level. In a 2-4 tree, a node may have one, two, or three elements. An interior 2-node contains one element and two children. An interior 3-node contains two elements and three children. An interior 4-node contains three elements and four children, as shown in Figure 47.1.



**Figure 47.1**

An interior node of a 2-4 tree has two, three, or four children.

<margin note: ordered>

Each child is a sub 2-4 tree, possibly empty. The root node has no parent, and leaf nodes have no children. The elements in the tree are distinct. The elements in a node are ordered such that

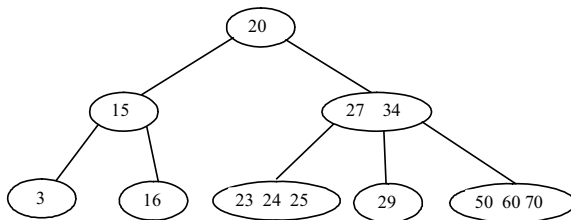
$$E(c_0) < e_0 < E(c_1) < e_1 < E(c_2) < e_2 < E(c_3)$$

<margin note:  $E(c_k)$ >

<margin note: left subtree>

<margin note: right subtree>

where  $E(c_k)$  denote the elements in  $c_k$ . Figure 47.2 shows an example of a 2-4 tree.  $c_k$  is called the *left subtree* of  $e_k$  and  $c_{k+1}$  is called the *right subtree* of  $e_k$ .



**Figure 47.2**

A 2-4 tree is a full complete search tree.

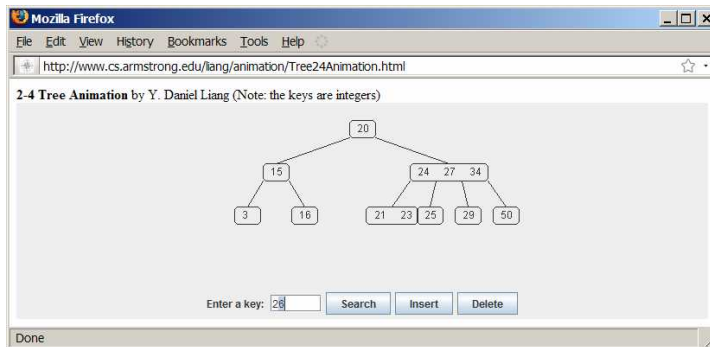
<margin note: binary vs. 2-4>

In a binary tree, each node contains one element. A 2-4 tree tends to be shorter than a corresponding binary search tree, since a 2-4 tree node may contain two or three elements.

Pedagogical NOTE

**<side remark: 2-4 tree animation>**

Run from  
www.cs.armstrong.edu/liang/animation/Tree24Animation.html  
to see how a 2-4 tree works, as shown in Figure 47.3.



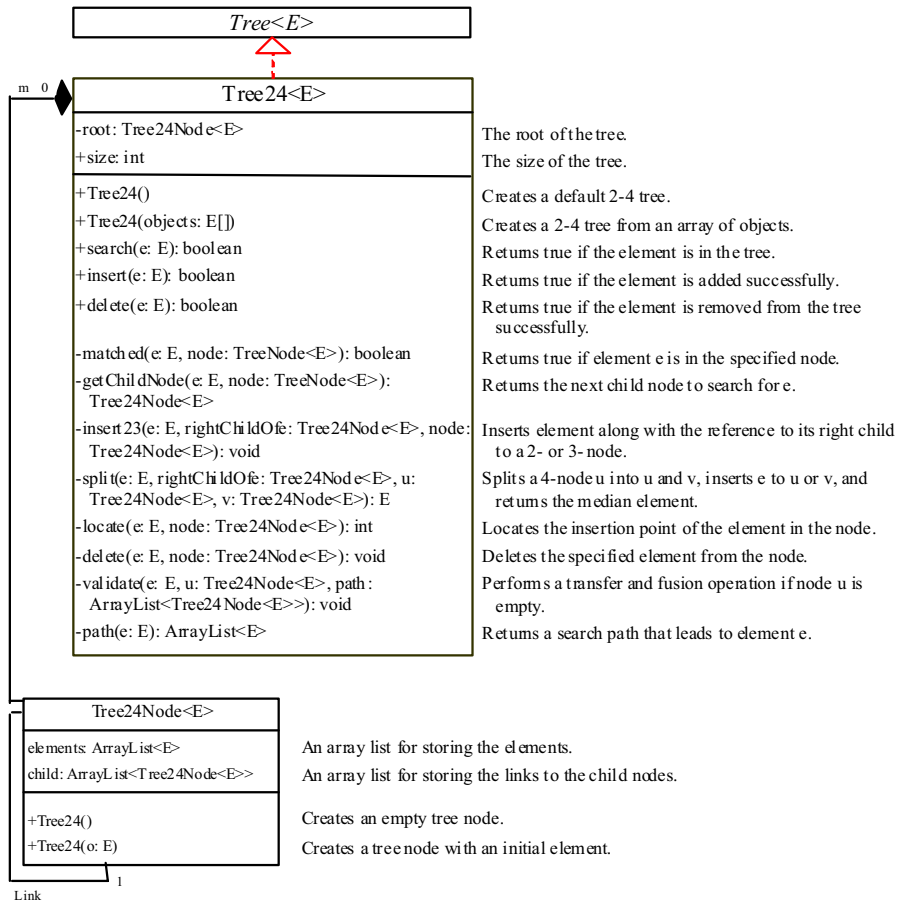
**Figure 47.3**

*The animation tool enables you to insert, delete, and search elements in a 2-4 tree visually.*

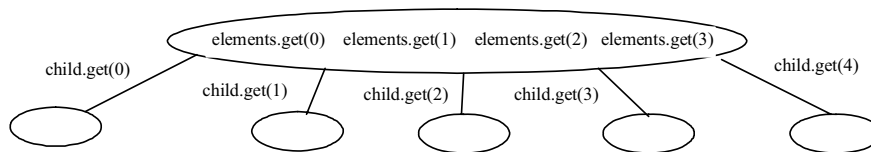
**\*\*\*End NOTE**

### 47.2 Designing Classes for 2-4 Trees

The `Tree24` class can be designed by implementing the `Tree` interface, as shown in Figure 47.4. The `Tree` interface was defined in Listing 27.3 `Tree.java`. The `Tree24Node` class defines tree nodes. The elements in the node are stored in a list named `elements` and the links to the child nodes are stored in a list named `child`, as shown in Figure 47.5.



**Figure 47.4**  
The *Tree24* class implements *Tree*.



**Figure 47.5**  
A 2-4 tree node stores the elements and the links to the child nodes in array lists.

### 47.3 Searching an Element

Searching an element in a 2-4 tree is similar to searching an element in a binary tree. The difference is that you have to search an element within a node in addition to searching elements along the path. To search an element in a 2-4 tree, you start from the root and scan down. If an element is not in the node, move to an appropriate subtree. Repeat the process until a match is found or you arrive at an empty subtree. The algorithm is described in Listing 47.1.

### Listing 47.1 Searching an Element in a 2-4 Tree

<margin note line 2: start from root>  
 <margin note line 6: found>  
 <margin note line 9: search a subtree>  
 <margin note line 13: not found>

```

boolean search(E e) {
 current = root; // Start from the root

 while (current != null) {
 if (match(e, current)) { // Element is in the node
 return true; // Element is found
 }
 else {
 current = getChildNode(e, current); // Search in a subtree
 }
 }

 return false; // Element is not in the tree
}

```

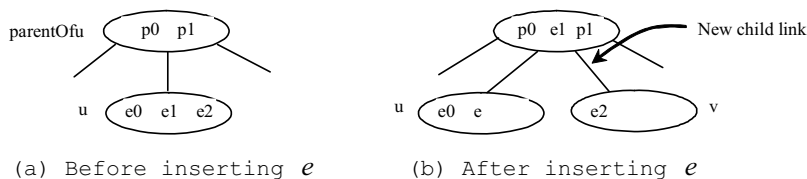
The `match(e, current)` method checks whether element `e` is in the current node. The `getChildNode(e, current)` method returns the root of the subtree for further search. Initially, let `current` point to the root (line 2). Repeat searching the element in the current node until `current` is `null` (line 4) or the element matches an element in the current node.

#### 47.4 Inserting an Element into a 2-4 Tree

<margin note: overflow>  
 <margin note: split>

To insert an element `e` to a 2-4 tree, locate a leaf node in which the element will be inserted. If the leaf node is a 2-node or 3-node, simply insert the element into the node. If the node is a 4-node, inserting a new element would cause an *overflow*. To resolve overflow, perform a *split* operation as follows:

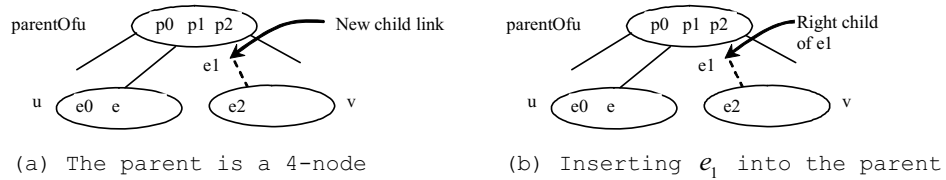
- Let `u` be the leaf 4-node in which the element will be inserted and `parentOfu` be the parent of `u`, as shown in Figure 47.6(a).
- Create a new node named `v`; move `e2` to `v`.
- If `e < e1`, insert `e` to `u`; otherwise insert `e` to `v`. Assume that `e0 < e < e1`, `e` is inserted into `u`, as shown in Figure 47.6(b).
- Insert `e1` along with its right child (i.e., `v`) to the parent node, as shown in Figure 47.6(b).



**Figure 47.6**

The splitting operation creates a new node and inserts the median element to its parent.

The parent node is a 3-node in Figure 47.6. So, there is room to insert  $e$  to the parent node. What happens if it is a 4-node, as shown in Figure 47.7? This requires that the parent node be split. The process is the same as splitting a leaf 4-node, except that you must also insert the element along with its right child.

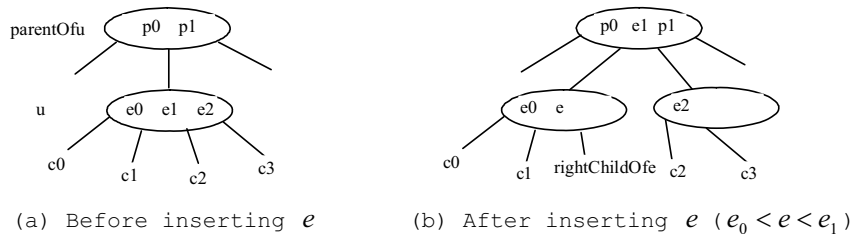


**Figure 47.7**

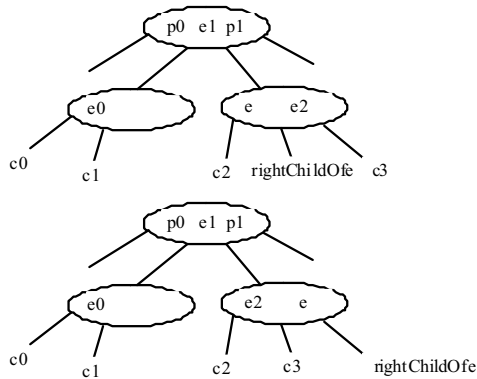
Insertion process continues if the parent node is a 4-node.

The algorithm can be modified as follows:

- Let  $u$  be the 4-node (*leaf or nonleaf*) in which the element will be inserted and  $parentOfu$  be the parent of  $u$ , as shown in Figure 47.8(a).
- Create a new node named  $v$ , move  $e_2$  and its children  $c_2$  and  $c_3$  to  $v$ .
- If  $e < e_1$ , insert  $e$  along with its right child link to  $u$ ; otherwise insert  $e$  along with its right child link to  $v$ , as shown in Figure 47.6(b), (c), (d) for the cases  $e_0 < e < e_1$ ,  $e_1 < e < e_2$ , and  $e_2 < e$ , respectively.
- Insert  $e_1$  along with its right child (i.e.,  $v$ ) to the parent node, recursively.







(c) After inserting  $e$  ( $e_1 < e < e_2$ ) (d) After inserting  $e$  ( $e_2 < e$ )

**Figure 47.8**

An interior node may be split to resolve overflow.

Listing 47.2 gives an algorithm for inserting an element.

**Listing 47.2 Inserting an Element to a 2-4 Tree**

*<margin note line 3: create a new node>*  
*<margin note line 5: search e>*  
*<margin note line 6: insert e>*  
*<margin note line 9: one element added>*  
*<margin note line 10: element added>*  
*<margin note line 13: insert to a node>*  
*<margin note line 15: a 2- or 3- node>*  
*<margin note line 20: split 4-node>*  
*<margin note line 23: new root>*  
*<margin note line 29: insert median to parent>*

```
public boolean insert(E e) {
 if (root == null)
 root = new Tree24Node<E>(e); // Create a new root for element
 else {
 Locate leafNode for inserting e
 insert(e, null, leafNode); // The right child of e is null
 }

 size++; // Increase size
 return true; // Element inserted
}

private void insert(E e, Tree24Node<E> rightChildOfe,
 Tree24Node<E> u) {
 if (u is a 2- or 3- node) { // u is a 2- or 3-node
 insert23(e, rightChildOfe, u); // Insert e to node u
 }
 else { // Split a 4-node u
 Tree24Node<E> v = new Tree24Node<E>(); // Create a new node
 E median = split(e, rightChildOfe, u, v); // Split u

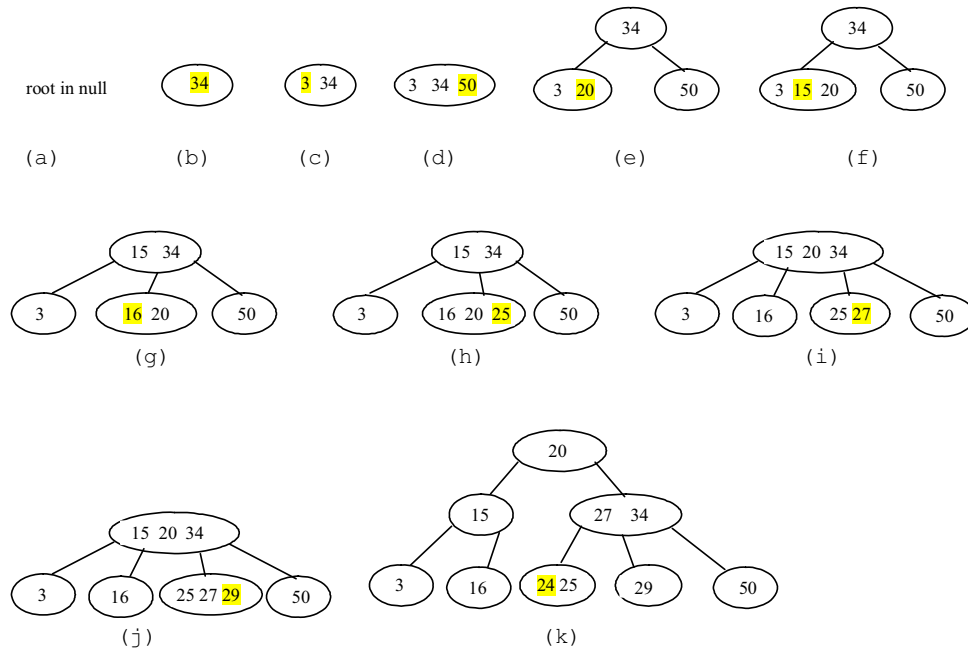
 if (u == root) { // u is the root
 root = new Tree24Node<E>(median); // New root
 }
 }
}
```

```

 root.child.add(u); // u is the left child of median
 root.child.add(v); // v is the right child of median
 }
 else {
 Get the parent of u, parentOfu;
 insert(median, v, parentOfu); // Inserting median to parent
 }
}
}
}

```

The `insert(E e, Tree24Node<E> rightChildOfe, Tree24Node<E> u)` method inserts element `e` along with its right child to node `u`. When inserting `e` to a leaf node, the right child of `e` is `null` (line 6). If the node is a 2- or 3-node, simply insert the element to the node (lines 15-17). If the node is a 4-node, invoke the `split` method to split the node (line 20). The `split` method returns the median element. Recursively invoke the `insert` method to insert the median element to the parent node (line 29). Figure 47.9 shows the steps of inserting elements `34`, `3`, `50`, `20`, `15`, `16`, `25`, `27`, `29`, and `24` into a 2-4 tree.



**Figure 47.9**

The tree changes after `34`, `3`, `50`, `20`, `15`, `16`, `25`, `27`, `29`, and `24` are added into an empty tree.

#### 47.5 Deleting an Element from a 2-4 Tree

To delete an element from a 2-4 tree, first search the element in the tree to locate the node that contains it. If the element is not in the tree, the method returns `false`. Let `u` be the node that contains the element and `parentOfu` be the parent of `u`. Consider three cases:

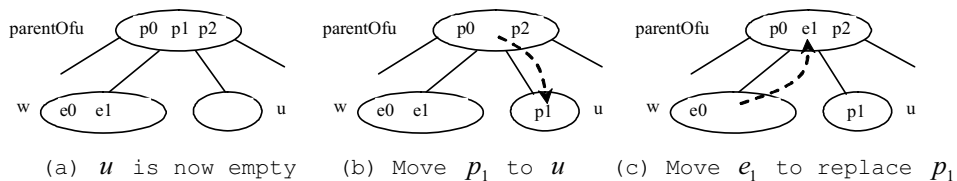
Case 1:  $u$  is a leaf 3-node or 4-node. Delete  $e$  from  $u$ .

<margin note: underflow>

Case 2:  $u$  is a leaf 2-node. Delete  $e$  from  $u$ . Now  $u$  is empty. This situation is known as *underflow*. To remedy an underflow, consider two subcases:

<margin note: transfer>

Case 2.1:  $u$ 's immediate left or right sibling is a 3- or 4-node. Let the node be  $w$ , as shown in Figure 47.10(a) (assume that  $w$  is a left sibling of  $u$ ). Perform a *transfer* operation that moves an element from *parentOfu* to  $u$ , as shown in Figure 47.10(b), and move an element from  $w$  to replace the moved element in *parentOfu*, as shown in Figure 47.10(c).

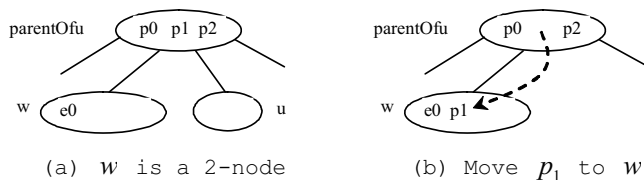


**Figure 47.10**

The transfer operation fills the empty node  $u$ .

<margin note: fusion>

Case 2.2: Both  $u$ 's immediate left and right sibling are 2-node if they exist ( $u$  may have only one sibling). Let the node be  $w$ , as shown in Figure 47.11(a) (assume that  $w$  is a left sibling of  $u$ ). Perform a *fusion* operation that discards  $u$  and moves an element from *parentOfu* to  $w$ , as shown in Figure 47.11(b). If *parentOfu* becomes empty, repeat Case 2 recursively to perform a transfer or a fusion on *parentOfu*.

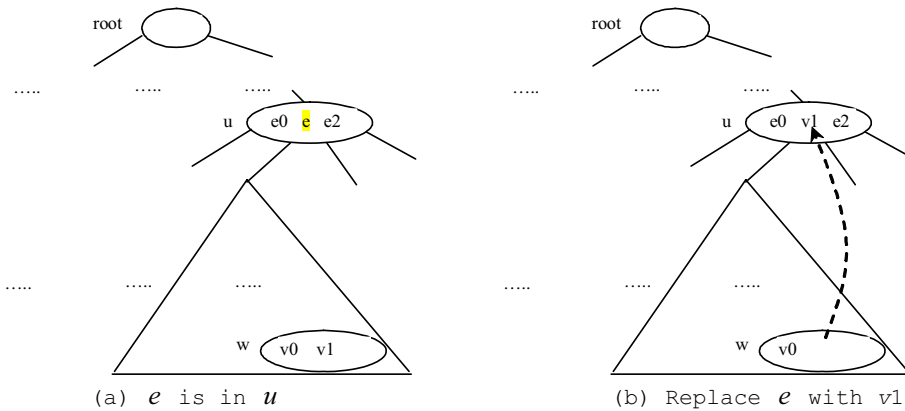


**Figure 47.11**

The fusion operation discards the empty node  $u$ .

<margin note: internal node>

Case 3:  $u$  is a nonleaf node. Find the rightmost leaf node in the left subtree of  $e$ . Let this node be  $w$ , as shown in Figure 47.12(a). Move the last element in  $w$  to replace  $e$  in  $u$ , as shown in Figure 47.12(b). If  $w$  becomes empty, apply a transfer or fusion operation on  $w$ .



**Figure 47.12**

An element in the internal node is replaced by an element in a leaf node.

Listing 47.3 describes the algorithm for deleting an element.

**Listing 47.3 Deleting an Element from a 2-4 Tree**

```

<margin note line 3: locate the node>
<margin note line 5: delete e>
<margin note line 10: element not found>
<margin note line 14: delete e>
<margin note line 19: delete e>
<margin note line 22: check and fix underflow>
<margin note line 25: locate rightmost element>
<margin note line 34: check and fix underflow>
<margin note line 39: check and fix underflow>

/** Delete the specified element from the tree */
public boolean delete(E e) {
 Locate the node that contains the element e
 if (the node is found) {
 delete(e, node); // Delete element e from the node
 size--; // After one element deleted
 return true; // Element deleted successfully
 }

 return false; // Element not in the tree
}

/** Delete the specified element from the node */
private void delete(E e, Tree24Node<E> node) {
 if (e is in a leaf node) {
 // Get the path that leads to e from the root
 ArrayList<Tree24Node<E>> path = path(e);

 Remove e from the node;

 // Check node for underflow along the path and fix it
 validate(e, node, path); // Check underflow node
 }
 else { // e is in an internal node

```

```

 Locate the rightmost node in the left subtree of node u;
 Get the rightmost element from the rightmost node;

 // Get the path that leads to e from the root
 ArrayList<Tree24Node<E>> path = path(rightmostElement);

 Replace the element in the node with the rightmost element

 // Check node for underflow along the path and fix it
 validate(rightmostElement, rightmostNode, path);
}
}

/** Perform a transfer or fusion operation if necessary */
private void validate(E e, Tree24Node<E> u,
 ArrayList<Tree24Node<E>> path) {
 for (int i = path.size() - 1; i >= 0; i--) {
 if (u is not empty)
 return; // Done, no need to perform transfer or fusion

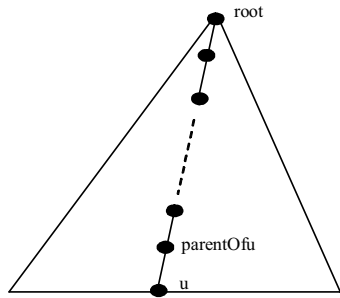
 Tree24Node<E> parentOfu = path.get(i - 1); // Get parent of u

 // Check two siblings
 if (left sibling of u has more than one element) {
 Perform a transfer on u with its left sibling
 }
 else if (right sibling of u has more than one element) {
 Perform a transfer on u with its right sibling
 }
 else if (u has left sibling) { // Fusion with a left sibling
 Perform a fusion on u with its left sibling
 u = parentOfu; // Back to the loop to check the parent node
 }
 else { // Fusion with right sibling (right sibling must exist)
 Perform a fusion on u with its right sibling
 u = parentOfu; // Back to the loop to check the parent node
 }
 }
}
}
}

```

The `delete(E e)` method locates the node that contains the element `e` and invokes the `delete(E e, Tree24Node<E> node)` method (line 5) to delete the element from the node.

If the node is a leaf node, get the path that leads to `e` from the root (line 17), delete `e` from the node (line 19), and invoke `validate` to check and fix the empty node (line 22). The `validate(E e, Tree24Node<E> u, ArrayList<Tree24Node<E>> path)` method performs a transfer or fusion operation if the node is empty. Since these operations may cause the parent of node `u` to become empty, a path is obtained in order to obtain the parents along the path from the root to node `u`, as shown in Figure 47.13.



**Figure 47.13**

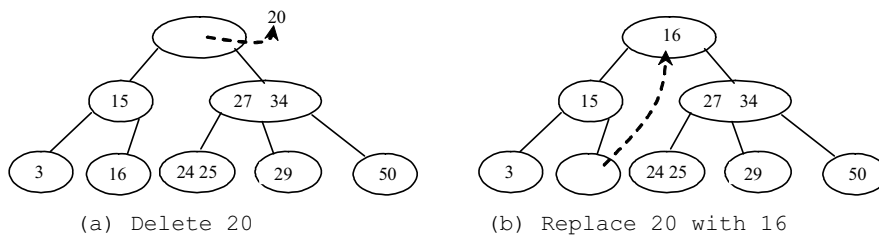
The nodes along the path may become empty as result of a transfer and fusion operation.

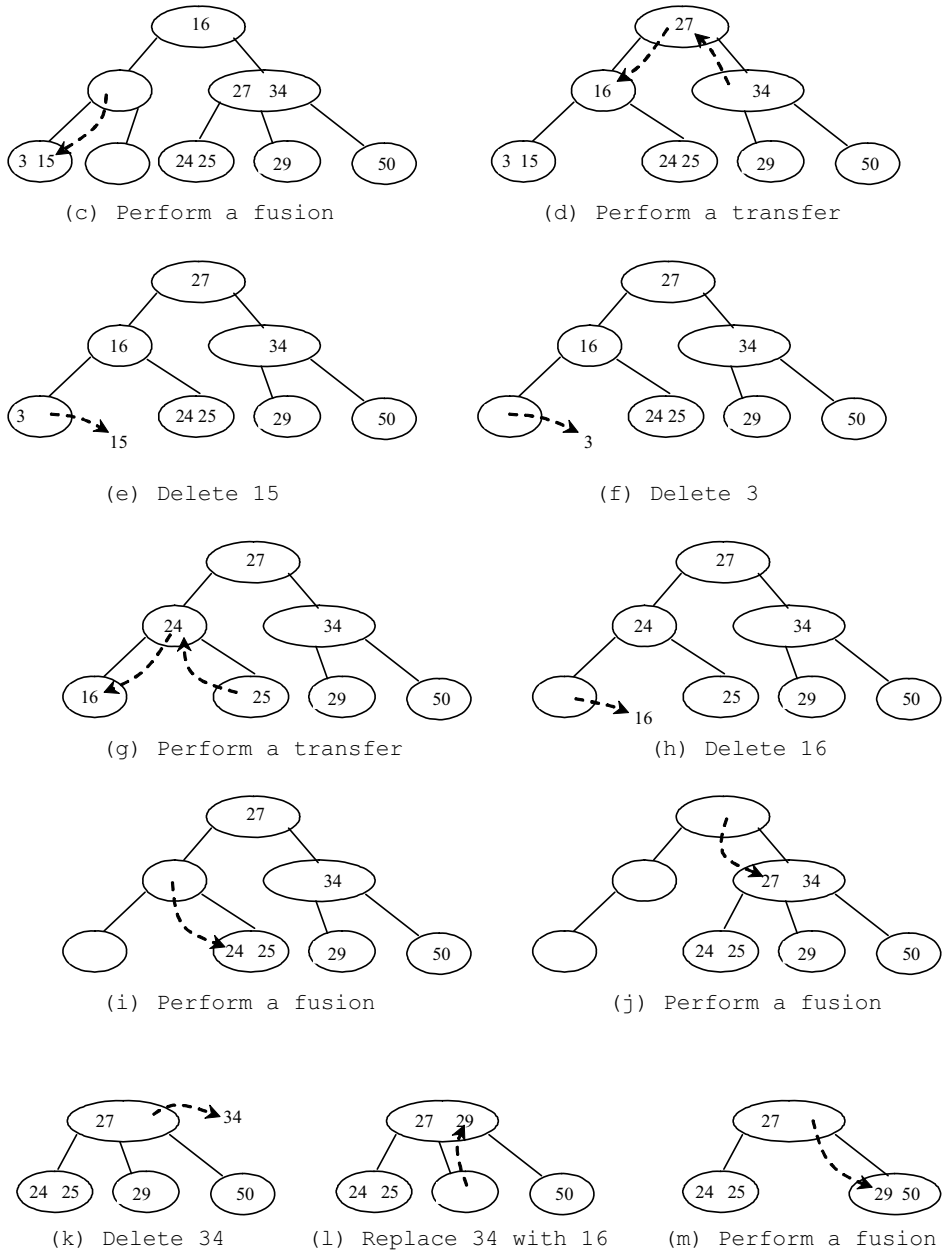
If the node is a nonleaf node, locate the rightmost element in the left subtree of the node (lines 25-26), get the path that leads to the rightmost element from the root (line 29), replace  $\underline{e}$  in the node with the rightmost element (line 31), and invoke validate to fix the rightmost node if it is empty (line 34).

The validate(E  $\underline{e}$ , Tree24Node<E>  $\underline{u}$ , ArrayList<Tree24Node<E>> path) checks whether  $\underline{u}$  is empty and performs a transfer or fusion operation to fix the empty node. The validate method exits when node is not empty (line 43). Otherwise, consider one of the following cases:

1. If  $\underline{u}$  has a left sibling with more than one element, perform a transfer on  $\underline{u}$  with its left sibling (line 49).
2. Otherwise, if  $\underline{u}$  has a right sibling with more than one element, perform a transfer on  $\underline{u}$  with its right sibling (line 52).
3. Otherwise, if  $\underline{u}$  has a left sibling, perform a fusion on  $\underline{u}$  with its left sibling (line 55) and reset  $\underline{u}$  to parentOfu (line 56).
4. Otherwise,  $\underline{u}$  must have a right sibling. Perform a fusion on  $\underline{u}$  with its right sibling (line 59) and reset  $\underline{u}$  to parentOfu (line 60).

Only one of the preceding cases is executed. Afterward, a new iteration starts to perform a transfer or fusion operation on a new node  $\underline{u}$  if needed. Figure 47.14 shows the steps of deleting elements 20, 15, 3, 6, and 34 are deleted from a 2-4 tree in Figure 47.9(k).





**Figure 47.14**

The tree changes after 20, 15, 3, 6, and 34 are deleted from a 2-4 tree.

#### 47.6 Traversing Elements in a 2-4 Tree

Inorder, preorder, and postorder traversals are useful for 2-4 trees. Inorder traversal visits the elements in increasing order. Preorder traversal visits the elements in the root, then recursively visits the subtrees from the left to right. Postorder traversal visits the

subtrees from the left to right recursively, and then the elements in the root.

For example, in the 2-4 tree in Figure 47.9(k), the inorder traversal is

3 15 16 20 24 25 27 29 34 50

The preorder traversal is

20 15 3 16 27 34 24 25 29 50

The postorder traversal is

3 16 1 24 25 29 50 27 34 20

#### 47.7 Implementing the Tree24 Class

Listing 47.4 gives the complete source code for the Tree24 class.

##### Listing 47.4 Tree24.java

```
<margin note line 4: root>
<margin note line 5: size>
<margin note line 8: no-arg constructor>
<margin note line 12: constructor>
<margin note line 18: search>
<margin note line 22: found?>
<margin note line 26: next subtree>
<margin note line 34: find a match>
<margin note line 36: matched?>
<margin note line 43: next subtree>
<margin note line 44: leaf node?>
<margin note line 47: insertion point>
<margin note line 54: insert to tree>
<margin note line 55: empty tree?>
<margin note line 59: find leaf node>
<margin note line 71: insert to node>
<margin note line 79: insert to node>
<margin note line 85: no overflow>
<margin note line 90: overflow>
<margin note line 91: split>
<margin note line 93: u is root?>
<margin note line 101: insert to parentOfu>
<margin note line 110: insert to node>
<margin note line 112: insertion point>
<margin note line 119: split>
<margin note line 123: get median>
<margin note line 127: insert e>
<margin note line 133: insert rightChildOfe>
<margin note line 138: return median>
<margin note line 142: get path>
<margin note line 147: add node searched>
<margin note line 156: return path>
<margin note line 160: delete from tree>
<margin note line 162: locate the node>
<margin note line 164: found?>
<margin note line 165: delete from node>
<margin note line 177: delete from node>
<margin note line 178: leaf node?>
```



<margin note line 182: delete e>  
 <margin note line 184: node is root?>  
 <margin note line 190: validate tree>  
 <margin note line 192: nonleaf node>  
 <margin note line 194: rightmost element>  
 <margin note line 206: replace element>  
 <margin note line 209: validate tree>  
 <margin note line 214: validate tree>  
 <margin note line 222: transfer with left sibling>  
 <margin note line 226: transfer with right sibling>  
 <margin note line 233: fusion with left sibling>  
 <margin note line 248: fusion with right sibling>  
 <margin note line 262: locate insertion point>  
 <margin note line 273: transfer with left sibling>  
 <margin note line 290: transfer with right sibling>  
 <margin note line 305: fusion with left sibling>  
 <margin note line 319: fusion with right sibling>  
 <margin note line 338: preorder>  
 <margin note line 343: recursive preorder>  
 <margin note line 343: recursive preorder>

<margin note line 374: inner Tree24Node class>  
 <margin note line 376: element list>  
 <margin note line 378: child list>

```

import java.util.ArrayList;

public class Tree24<E extends Comparable<E>> implements Tree<E> {
 private Tree24Node<E> root;
 private int size;

 /** Create a default 2-4 tree */
 public Tree24() {
 }

 /** Create a 2-4 tree from an array of objects */
 public Tree24(E[] elements) {
 for (int i = 0; i < elements.length; i++)
 insert(elements[i]);
 }

 /** Search an element in the tree */
 public boolean search(E e) {
 Tree24Node<E> current = root; // Start from the root

 while (current != null) {
 if (matched(e, current)) { // Element is in the node
 return true; // Element found
 }
 else {
 current = getChildNode(e, current); // Search in a subtree
 }
 }

 return false; // Element is not in the tree
 }
}

```

```

/** Return true if the element is found in this node */
private boolean matched(E e, Tree24Node<E> node) {
 for (int i = 0; i < node.elements.size(); i++)
 if (node.elements.get(i).equals(e))
 return true; // Element found

 return false; // No match in this node
}

/** Locate a child node to search element e */
private Tree24Node<E> getChildNode(E e, Tree24Node<E> node) {
 if (node.child.size() == 0)
 return null; // node is a leaf

 int i = locate(e, node); // Locate the insertion point for e
 return node.child.get(i); // Return the child node
}

/** Insert element e into the tree
 * Return true if the element is inserted successfully
 */
public boolean insert(E e) {
 if (root == null)
 root = new Tree24Node<E>(e); // Create a new root for element
 else {
 // Locate the leaf node for inserting e
 Tree24Node<E> leafNode = null;
 Tree24Node<E> current = root;
 while (current != null)
 if (matched(e, current)) {
 return false; // Duplicate element found, nothing inserted
 }
 else {
 leafNode = current;
 current = getChildNode(e, current);
 }

 // Insert the element e into the leaf node
 insert(e, null, leafNode); // The right child of e is null
 }

 size++; // Increase size
 return true; // Element inserted
}

/** Insert element e into node u */
private void insert(E e, Tree24Node<E> rightChildOfe,
 Tree24Node<E> u) {
 // Get the search path that leads to element e
 ArrayList<Tree24Node<E>> path = path(e);

 for (int i = path.size() - 1; i >= 0; i--) {
 if (u.elements.size() < 3) { // u is a 2-node or 3-node
 insert23(e, rightChildOfe, u); // Insert e to node u
 break; // No further insertion to u's parent needed
 }
 }
}

```

```

else {
 Tree24Node<E> v = new Tree24Node<E>(); // Create a new node
 E median = split(e, rightChildOfe, u, v); // Split u

 if (u == root) {
 root = new Tree24Node<E>(median); // New root
 root.child.add(u); // u is the left child of median
 root.child.add(v); // v is the right child of median
 break; // No further insertion to u's parent needed
 }
 else {
 // Use new values for the next iteration in the for loop
 e = median; // Element to be inserted to parent
 rightChildOfe = v; // Right child of the element
 u = path.get(i - 1); // New node to insert element
 }
}
}

/** Insert element to a 2- or 3- and return the insertion point */
private void insert23(E e, Tree24Node<E> rightChildOfe,
 Tree24Node<E> node) {
 int i = this.locate(e, node); // Locate where to insert
 node.elements.add(i, e); // Insert the element into the node
 if (rightChildOfe != null)
 node.child.add(i + 1, rightChildOfe); // Insert the child link
}

/** Split a 4-node u into u and v and insert e to u or v */
private E split(E e, Tree24Node<E> rightChildOfe,
 Tree24Node<E> u, Tree24Node<E> v) {
 // Move the last element in node u to node v
 v.elements.add(u.elements.remove(2));
 E median = u.elements.remove(1);

 // Split children for a nonleaf node
 // Move the last two children in node u to node v
 if (u.child.size() > 0) {
 v.child.add(u.child.remove(2));
 v.child.add(u.child.remove(2));
 }

 // Insert e into a 2- or 3- node u or v.
 if (e.compareTo(median) < 0)
 insert23(e, rightChildOfe, u);
 else
 insert23(e, rightChildOfe, v);

 return median; // Return the median element
}

/** Return a search path that leads to element e */
private ArrayList<Tree24Node<E>> path(E e) {
 ArrayList<Tree24Node<E>> list = new ArrayList<Tree24Node<E>>();
 Tree24Node<E> current = root; // Start from the root

```

```

while (current != null) {
 list.add(current); // Add the node to the list
 if (matched(e, current)) {
 break; // Element found
 }
 else {
 current = getChildNode(e, current);
 }
}

return list; // Return an array of nodes
}

/** Delete the specified element from the tree */
public boolean delete(E e) {
 // Locate the node that contains the element e
 Tree24Node<E> node = root;
 while (node != null)
 if (matched(e, node)) {
 delete(e, node); // Delete element e from node
 size--; // After one element deleted
 return true; // Element deleted successfully
 }
 else {
 node = getChildNode(e, node);
 }

 return false; // Element not in the tree
}

/** Delete the specified element from the node */
private void delete(E e, Tree24Node<E> node) {
 if (node.child.size() == 0) { // e is in a leaf node
 // Get the path that leads to e from the root
 ArrayList<Tree24Node<E>> path = path(e);

 node.elements.remove(e); // Remove element e

 if (node == root) { // Special case
 if (node.elements.size() == 0)
 root = null; // Empty tree
 return; // Done
 }

 validate(e, node, path); // Check underflow node
 }
 else { // e is in an internal node
 // Locate the rightmost node in the left subtree of the node
 int index = locate(e, node); // Index of e in node
 Tree24Node<E> current = node.child.get(index);
 while (current.child.size() > 0) {
 current = current.child.get(current.child.size() - 1);
 }
 E rightmostElement =
 current.elements.get(current.elements.size() - 1);
 }
}

```

```

// Get the path that leads to e from the root
ArrayList<Tree24Node<E>> path = path(rightmostElement);

// Replace the deleted element with the rightmost element
node.elements.set(index, current.elements.remove(
 current.elements.size() - 1));

validate(rightmostElement, current, path); // Check underflow
}
}

/** Perform transfer and confusion operations if necessary */
private void validate(E e, Tree24Node<E> u,
 ArrayList<Tree24Node<E>> path) {
 for (int i = path.size() - 1; u.elements.size() == 0; i--) {
 Tree24Node<E> parentOfu = path.get(i - 1); // Get parent of u
 int k = locate(e, parentOfu); // Index of e in the parent node

 // Check two siblings
 if (k > 0 && parentOfu.child.get(k - 1).elements.size() > 1) {
 leftSiblingTransfer(k, u, parentOfu);
 }
 else if (k + 1 < parentOfu.child.size() &&
 parentOfu.child.get(k + 1).elements.size() > 1) {
 rightSiblingTransfer(k, u, parentOfu);
 }
 else if (k - 1 >= 0) { // Fusion with a left sibling
 // Get left sibling of node u
 Tree24Node<E> leftNode = parentOfu.child.get(k - 1);

 // Perform a fusion with left sibling on node u
 leftSiblingFusion(k, leftNode, u, parentOfu);

 // Done when root becomes empty
 if (parentOfu == root && parentOfu.elements.size() == 0) {
 root = leftNode;
 break;
 }

 u = parentOfu; // Back to the loop to check the parent node
 }
 else { // Fusion with right sibling (right sibling must exist)
 // Get left sibling of node u
 Tree24Node<E> rightNode = parentOfu.child.get(k + 1);

 // Perform a fusion with right sibling on node u
 rightSiblingFusion(k, rightNode, u, parentOfu);

 // Done when root becomes empty
 if (parentOfu == root && parentOfu.elements.size() == 0) {
 root = rightNode;
 break;
 }

 u = parentOfu; // Back to the loop to check the parent node
 }
 }
}

```

```

 }
}

/** Locate the insertion point of the element in the node */
private int locate(E o, Tree24Node<E> node) {
 for (int i = 0; i < node.elements.size(); i++) {
 if (o.compareTo(node.elements.get(i)) <= 0) {
 return i;
 }
 }

 return node.elements.size();
}

/** Perform a transfer with a left sibling */
private void leftSiblingTransfer(int k,
 Tree24Node<E> u, Tree24Node<E> parentOfu) {
 // Move an element from the parent to u
 u.elements.add(0, parentOfu.elements.get(k - 1));

 // Move an element from the left node to the parent
 Tree24Node<E> leftNode = parentOfu.child.get(k - 1);
 parentOfu.elements.set(k - 1,
 leftNode.elements.remove(leftNode.elements.size() - 1));

 // Move the child link from left sibling to the node
 if (leftNode.child.size() > 0)
 u.child.add(0, leftNode.child.remove(
 leftNode.child.size() - 1));
}

/** Perform a transfer with a right sibling */
private void rightSiblingTransfer(int k,
 Tree24Node<E> u, Tree24Node<E> parentOfu) {
 // Transfer an element from the parent to u
 u.elements.add(parentOfu.elements.get(k));

 // Transfer an element from the right node to the parent
 Tree24Node<E> rightNode = parentOfu.child.get(k + 1);
 parentOfu.elements.set(k, rightNode.elements.remove(0));

 // Move the child link from right sibling to the node
 if (rightNode.child.size() > 0)
 u.child.add(rightNode.child.remove(0));
}

/** Perform a fusion with a left sibling */
private void leftSiblingFusion(int k, Tree24Node<E> leftNode,
 Tree24Node<E> u, Tree24Node<E> parentOfu) {
 // Transfer an element from the parent to the left sibling
 leftNode.elements.add(parentOfu.elements.remove(k - 1));

 // Remove the link to the empty node
 parentOfu.child.remove(k);
}

```

```

 // Adjust child links for nonleaf node
 if (u.child.size() > 0)
 leftNode.child.add(u.child.remove(0));
 }

 /** Perform a fusion with a right sibling */
 private void rightSiblingFusion(int k, Tree24Node<E> rightNode,
 Tree24Node<E> u, Tree24Node<E> parentOfu) {
 // Transfer an element from the parent to the right sibling
 rightNode.elements.add(0, parentOfu.elements.remove(k));

 // Remove the link to the empty node
 parentOfu.child.remove(k);

 // Adjust child links for nonleaf node
 if (u.child.size() > 0)
 rightNode.child.add(0, u.child.remove(0));
 }

 /** Get the number of nodes in the tree */
 public int getSize() {
 return size;
 }

 /** Preorder traversal from the root */
 public void preorder() {
 preorder(root);
 }

 /** Preorder traversal from a subtree */
 private void preorder(Tree24Node<E> root) {
 if (root == null) return;
 for (int i = 0; i < root.elements.size(); i++)
 System.out.print(root.elements.get(i) + " ");

 for (int i = 0; i < root.child.size(); i++)
 preorder(root.child.get(i));
 }

 /** Inorder traversal from the root */
 public void inorder() {
 // Left as exercise
 }

 /** Postorder traversal from the root */
 public void postorder() {
 // Left as exercise
 }

 /** Return true if the tree is empty */
 public boolean isEmpty() {
 return root == null;
 }

 /** Return an iterator to traverse elements in the tree */
 public java.util.Iterator iterator() {

```

```

 // Left as exercise
 return null;
 }

 /** Define a 2-4 tree node */
 protected static class Tree24Node<E extends Comparable<E>> {
 // elements has maximum three values
 ArrayList<E> elements = new ArrayList<E>(3);
 // Each has maximum four children
 ArrayList<Tree24Node<E>> child
 = new ArrayList<Tree24Node<E>>(4);

 /** Create an empty Tree24 node */
 Tree24Node() {
 }

 /** Create a Tree24 node with an initial element */
 Tree24Node(E o) {
 elements.add(o);
 }
 }
}

```

<margin note: root>

<margin note: size>

The `Tree24` class contains the data fields `root` and `size` (lines 4-5). `root` references the root node and `size` stores the number of elements in the tree.

<margin note: constructors>

The `Tree24` class has two constructors: a no-arg constructor (lines 8-9) that constructs an empty tree and a constructor that creates an initial `Tree24` from an array of elements (lines 12-15).

<margin note: search>

The `search` method (lines 18-31) searches an element in the tree. It returns `true` (line 23) if the element is in the tree and returns `false` if the search arrives at an empty subtree (line 30).

<margin note: matched>

The `matched(e, node)` method (lines 34-40) checks where the element `e` is in the node.

<margin note: getChildNode>

The `getChildNode(e, node)` method (lines 43-49) returns the root of a subtree where `e` should be searched.

<margin note: insert(e)>

The `insert(E e)` method inserts an element in a tree (lines 54-78). If the tree is empty, a new root is created (line 56). The method locates a leaf node in which the element will be inserted and invokes `insert(e, null, leafNode)` to insert the element (line 71).

<margin note: insert(e, rightChildOfe, u)>

The `insert(e, rightChildOfe, u)` method inserts an element into node `u` (lines 79-107). The method first invokes `path(e)` (line 82) to obtain a search path from the root to node `u`. Each iteration of the `for` loop considers `u` and its parent `parentOfu` (lines 84-106). If `u` is a 2-node



or 3-node, invoke `insert23(e, rightChildOfe, u)` to insert `e` and its child link `rightChildOfe` into `u` (line 86). No split is needed (line 87). Otherwise, create a new node `v` (line 90) and invoke `split(e, rightChildOfe, u, v)` (line 91) to split `u` into `u` and `v`. The `split` method inserts `e` into either `u` and `v` and returns the median in the original `u`. If `u` is the root, create a new root to hold median, and set `u` and `v` as the left and right children for median (lines 95-96). If `u` is not the root, insert median to `parentOfu` in the next iteration (lines 101-103).

**<margin note: `insert23`>**

The `insert23(e, rightChildOfe, node)` method inserts `e` along with the reference to its right child into the node (lines 110-116). The method first invokes `locate(e, node)` (line 112) to locate an insertion point, then insert `e` into the node (line 113). If `rightChildOfe` is not `null`, it is inserted into the child list of the node (line 115).

**<margin note: `split`>**

The `split(e, rightChildOfe, u, v)` method splits a 4-node `u` (lines 119-139). This is accomplished as follows: (1) move the last element from `u` to `v` and remove the median element from `u` (lines 122-123); (2) move the last two child links from `u` to `v` (lines 127-130) if `u` is a nonleaf node; (3) if `e < median`, insert `e` into `u`; otherwise, insert `e` into `v` (lines 133-136); (4) return median (line 138).

**<margin note: `path`>**

The `path(e)` method returns an `ArrayList` of nodes searched from the root in order to locate `e` (lines 142-157). If `e` is in the tree, the last node in the path contains `e`. Otherwise the last node is where `e` should be inserted.

**<margin note: `delete(e)`>**

The `delete(E e)` method deletes an element from the tree (lines 160-174). The method first locates the node that contains `e` and invokes `delete(e, node)` to delete `e` from the node (line 165). If the element is not in the tree, return `false` (line 173).

**<margin note: `delete(e, node)`>**

The `delete(e, node)` method deletes an element from node `u` (lines 177-211). If the node is a leaf node, obtain the path that leads to `e` (line 180), delete `e` (line 182), set root to `null` if the tree becomes empty (lines 184-188), and invoke `validate` to apply transfer and fusion operation on empty nodes (line 190). If the node is a nonleaf node, locate the rightmost element (lines 194-200), obtain the path that leads to `e` (line 203), replace `e` with the rightmost element (lines 206-207), and invoke `validate` to apply transfer and fusion operations on empty nodes (line 209).

**<margin note: `validate`>**

The `validate(e, u, path)` method ensures that the tree is a valid 2-4 tree (lines 214-259). The `for` loop terminates when `u` is not empty (line 216). The loop body is executed to fix the empty node `u` by performing a transfer or fusion operation. If a left sibling with more than one element exists, perform a transfer on `u` with the left sibling (line 222). Otherwise, if a right sibling with more than one element exists, perform a transfer on `u` with the left sibling (line 226). Otherwise, if a left sibling exists, perform a fusion on `u` with the left sibling (lines 230-239), and validate `parentOfu` in the next loop iteration (line 241). Otherwise, perform a fusion on `u` with the right sibling.

<margin note: [locate](#)>

The `locate(e, node)` method locates the index of `e` in the node (lines 262-270).

<margin note: [transfer](#)>

<margin note: [fusion](#)>

The `leftSiblingTransfer(k, u, parentOfu)` method performs a transfer on `u` with its left sibling (lines 273-287). The `rightSiblingTransfer(k, u, parentOfu)` method performs a transfer on `u` with its right sibling (lines 290-302). The `leftSiblingFusion(k, leftNode, u, parentOfu)` method performs a fusion on `u` with its left sibling `leftNode` (lines 305-316). The `rightSiblingFusion(k, rightNode, u, parentOfu)` method performs a fusion on `u` with its right sibling `rightNode` (lines 319-330).

<margin note: [preorder](#)>

The `preorder()` method displays all the elements in the tree in preorder (lines 338-350).

<margin note: [Tree24Node](#)>

The inner class `Tree24Node` defines a class for a node in the tree (lines 374-389).

## 47.8 Testing the `Tree24` Class

Listing 47.5 gives a test program. The program creates a 2-4 tree and inserts elements in lines 6-20, and deletes elements in lines 22-56.

### Listing 47.5 TestTree24.java

<margin note line 4: [create a Tree24](#)>

<margin note line 6: [insert 34](#)>

<margin note line 7: [insert 3](#)>

<margin note line 8: [insert 50](#)>

<margin note line 15: [insert 24](#)>

<margin note line 21: [insert 70](#)>

<margin note line 25: [delete 34](#)>

```
1 public class TestTree24 {
2 public static void main(String[] args) {
3 // Create a 2-4 tree
4 Tree24<Integer> tree = new Tree24<Integer>();
5
6 tree.insert(34);
7 tree.insert(3);
8 tree.insert(50);
9 tree.insert(20);
10 tree.insert(15);
11 tree.insert(16);
12 tree.insert(25);
13 tree.insert(27);
14 tree.insert(29);
15 tree.insert(24);
16 System.out.print("\nAfter inserting 24:");
17 printTree(tree);
18 tree.insert(23);
19 tree.insert(22);
20 tree.insert(60);
21 tree.insert(70);
```

```

22 System.out.print("\nAfter inserting 70:");
23 printTree(tree);
24
25 tree.delete(34);
26 System.out.print("\nAfter deleting 34:");
27 printTree(tree);
28
29 tree.delete(25);
30 System.out.print("\nAfter deleting 25:");
31 printTree(tree);
32
33 tree.delete(50);
34 System.out.print("\nAfter deleting 50:");
35 printTree(tree);
36
37 tree.delete(16);
38 System.out.print("\nAfter deleting 16:");
39 printTree(tree);
40
41 tree.delete(3);
42 System.out.print("\nAfter deleting 3:");
43 printTree(tree);
44
45 tree.delete(15);
46 System.out.print("\nAfter deleting 15:");
47 printTree(tree);
48 }
49
50 public static void printTree(Tree tree) {
51 // Traverse tree
52 System.out.print("\nPreorder: ");
53 tree.preorder();
54 System.out.print("\nThe number of nodes is " + tree.getSize());
55 System.out.println();
56 }
57 }

```

#### <Output>

```

After inserting 24:
Preorder: 20 15 3 16 27 34 24 25 29 50
The number of nodes is 10

After inserting 70:
Preorder: 20 15 3 16 24 27 34 22 23 25 29 50 60 70
The number of nodes is 14

After deleting 34:
Preorder: 20 15 3 16 24 27 50 22 23 25 29 60 70
The number of nodes is 13

After deleting 25:
Preorder: 20 15 3 16 23 27 50 22 24 29 60 70
The number of nodes is 12

After deleting 50:
Preorder: 20 15 3 16 23 27 60 22 24 29 70
The number of nodes is 11

After deleting 16:

```

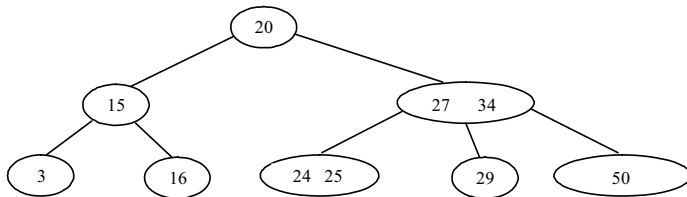
Preorder: 23 20 3 15 22 27 60 24 29 70  
 The number of nodes is 10

After deleting 3:  
 Preorder: 23 20 15 22 27 60 24 29 70  
 The number of nodes is 9

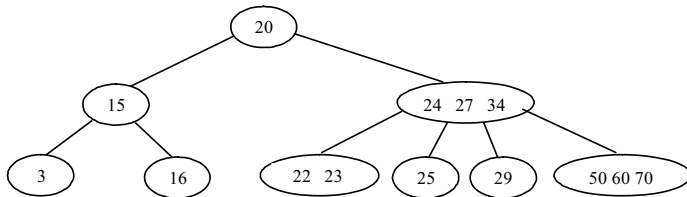
After deleting 15:  
 Preorder: 27 23 20 22 24 60 29 70  
 The number of nodes is 8

<End Output>

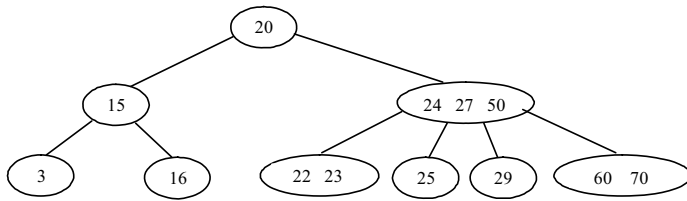
Figure 47.15 shows how the tree evolves as elements are added. After 34, 3, 50, 20, 15, 16, 25, 27, 29, and 24 are added to the tree, it is as shown in Figure 47.15(a). After inserting 23, 22, 60, and 70, the tree is as shown in Figure 47.15(b). After inserting 23, 22, 60, and 70, the tree is as shown in Figure 47.15(b). After deleting 34, the tree is as shown in Figure 47.15(c). After deleting 25, the tree is as shown in Figure 47.15(d). After deleting 50, the tree is as shown in Figure 47.15(e). After deleting 16, the tree is as shown in Figure 47.15(f). After deleting 3, the tree is as shown in Figure 47.15(g). After deleting 15, the tree is as shown in Figure 47.15(h).



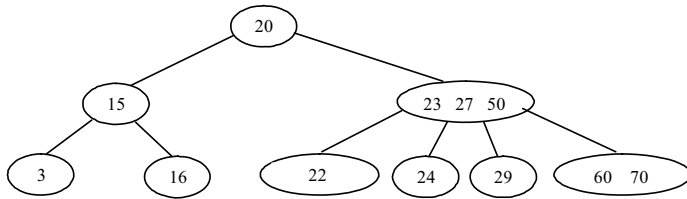
(a) After inserting 34, 3, 50, 20, 15, 16, 25, 27, 29, and 24, in this order



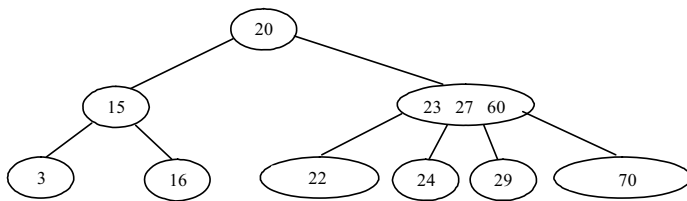
(b) After inserting 23, 22, 60, and 70



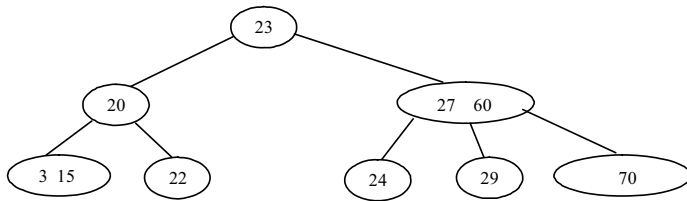
(c) After deleting 34



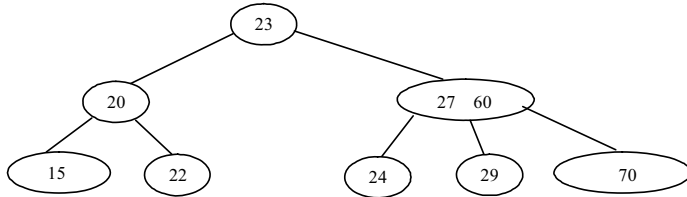
(d) After deleting 25



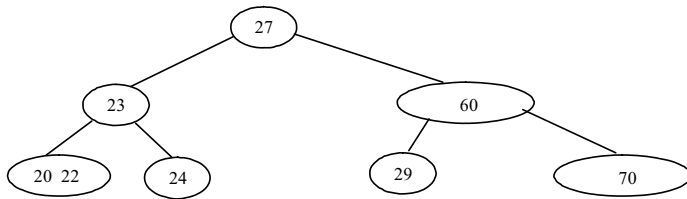
(e) After deleting 50



(f) After deleting 16



(g) After deleting 3



(h) After deleting 15

**Figure 47.15**

The tree evolves as elements are inserted and deleted.

### 47.9 Time-Complexity Analysis

Since a 2-4 tree is a completely balanced binary tree, its height is at most  $O(\log n)$ . The search, insert, and delete methods operate on the nodes along a path in the tree. It takes a constant time to search an element within a node. So, the search method takes  $O(\log n)$  time. For the insert method, the time for splitting a node takes a constant time. So, the insert method takes  $O(\log n)$  time. For the delete method, it takes a constant time to perform a transfer and fusion operation. So, the delete method takes  $O(\log n)$  time.

### 47.10 B-Tree

So far we assume that the entire data set is stored in main memory. What if the data set is too large and cannot fit in the main memory, as in the case with most databases where data is stored on disks? Suppose you use an AVL tree to organize a million records in a database table. To find a record, the average number of nodes traversed is

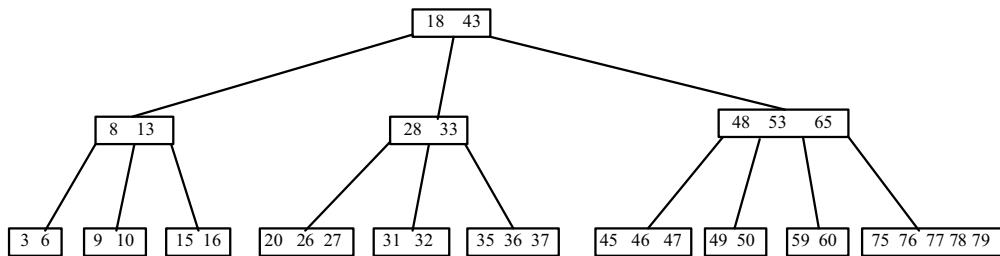
$\log_2 1,000,000 \approx 20$ . This is fine if all nodes are stored in main memory. However, for nodes stored on a disk, this means 20 disk reads. Disk I/O is expensive, and it is thousands of times slower than memory access. To improve performance, we need to reduce the number of disk I/Os. An efficient data structure for performing search, insertion, and deletion

for data stored on secondary storage such as hard disks is the B-tree, which is a generalization of the 2-4 tree.

A B-tree of order  $d$  is defined as follows:

1. Each node except the root contains between  $\lceil d/2 \rceil - 1$  and  $d - 1$  keys.
2. The root may contain up to  $d - 1$  keys.
3. A nonleaf node with  $k$  keys has  $k + 1$  children.
4. All leaf nodes have the same depth.

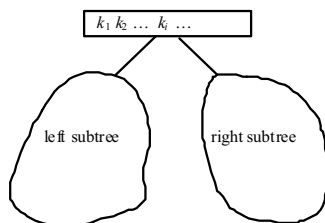
Figure 47.16 shows a B-tree of order 6. For simplicity, we use integers to represent keys. Each key is associated with a pointer that points to the actual record in the database. For simplicity, the pointers to the records in the database are omitted in the figure.



**Figure 47.16**

*In a B-tree of order 6, each node except the root may contain between 2 and 5 keys.*

Note that a B-tree is a search tree. The keys in each node are placed in increasing order. Each key in an interior node has a left subtree and a right subtree, as shown in Figure 47.17. All keys in the left subtree are less than the key in the parent node, and all keys in the right subtree are greater than the key in the parent node.



**Figure 47.17**

*The keys in the left (right) subtree of key  $k_i$  are less than (greater than)  $k_i$ .*

**<margin note: one block per node>**

The basic unit of the IO operations on a disk is a block. When you read data from a disk, the whole block that contains the data is read. You

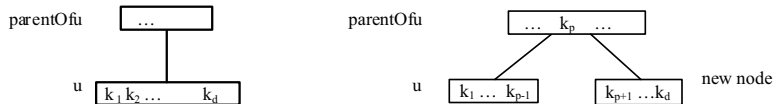
should choose an appropriate order  $d$  so that a node can fit in a single disk block. This will minimize the number of disk IOs.

A 2-4 tree is actually a B-tree of order 4. The techniques for insertion and deletion in a 2-4 tree can be easily generalized for a B-tree.

**<margin note: insertion>**

Inserting a key to a B-tree is similar to what was done for a 2-4 tree. First locate the leaf node in which the key will be inserted. Insert the key to the node. After the insertion, if the leaf node has  $d$  keys, an overflow occurs. To resolve overflow, perform a *split* operation similar to the one used in a 2-4 tree, as follows:

Let  $u$  denote the node needed to be split and let  $\underline{m}$  denote the median key in the node. Create a new node and move all keys greater than  $\underline{m}$  to this new node. Insert  $\underline{m}$  to the parent node of  $u$ . Now  $u$  becomes the left child of  $\underline{m}$  and  $v$  becomes the right child of  $\underline{m}$ , as shown in Figure 47.18. If inserting  $\underline{m}$  into the parent node of  $u$  causes an overflow, repeat the same split process on the parent node.



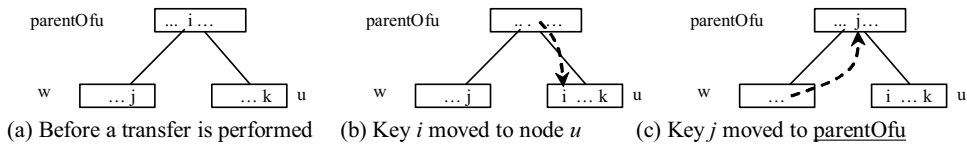
**Figure 47.18**

(a) After inserting a new key to node  $u$ . (b) The median key  $k_p$  is inserted to  $\underline{\text{parentOf}u}$ .

**<margin note: deletion>**

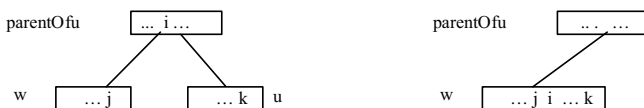
A key  $k$  can be deleted from a B-tree in the same way as in a 2-4 tree. First locate the node  $u$  that contains the key. Consider two cases:

Case 1: If  $u$  is a leaf node, remove the key from  $u$ . After the removal, if  $u$  has less than  $\lceil d/2 \rceil - 1$  keys, an underflow occurs. To remedy an underflow, perform a transfer with a sibling  $w$  of  $u$  that has more than  $\lceil d/2 \rceil - 1$  keys if such sibling exists, as shown in Figure 47.19. Otherwise perform a fusion with a sibling  $w$  of  $u$ , as shown in Figure 47.20.



**Figure 47.19**

The transfer operation transfers a key from the  $\underline{\text{parentOf}u}$  to  $u$  and transfers a key from  $u$ 's sibling  $\underline{\text{parentOf}u}$ .





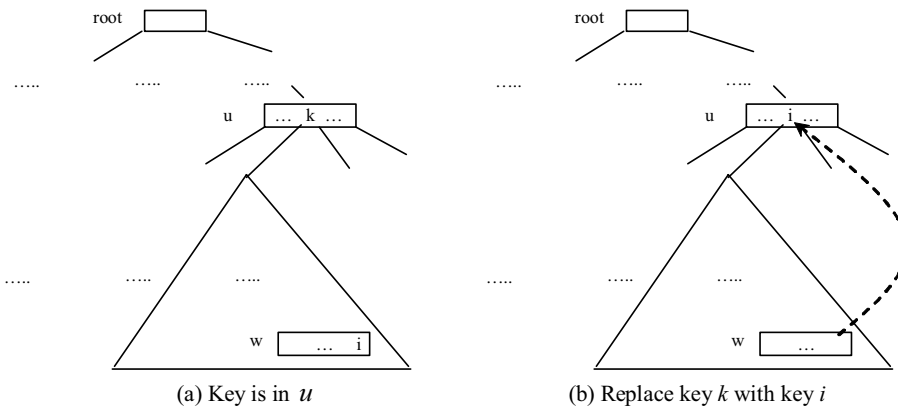
(a) Before a fusion is performed

(b) After a fusion is performed

**Figure 47.20**

The fusion operation moves key  $i$  from the parentOfu  $u$  to  $w$  and moves all keys in  $u$  to  $w$ .

Case 2:  $u$  is a nonleaf node. Find the rightmost leaf node in the left subtree of  $k$ . Let this node be  $w$ , as shown in Figure 47.21(a). Move the last key in  $w$  to replace  $k$  in  $u$ , as shown in Figure 47.21(b). If  $w$  becomes underflow, apply a transfer or fusion operation on  $w$ .



**Figure 47.21**

A key in the internal node is replaced by an element in a leaf node.

**<margin note: B-tree performance>**

The performance of a B-tree depends on the number of disk I/Os (i.e., the number of nodes accessed). The number of nodes accessed for search, insertion, and deletion operations depends on the height of the tree. In the worst case, each node contains  $\lceil d/2 \rceil - 1$  keys. So, the height of the tree is  $\log_{\lceil d/2 \rceil} n$ , where  $n$  is the number of keys. In the best case, each node contains  $d - 1$  keys. So, the height of the tree is  $\log_d n$ . Consider a B-tree of order 12 for ten million keys. The height of the tree is between  $\log_6 10,000,000 \approx 7$  and  $\log_{12} 10,000,000 \approx 9$ . So, for search, insertion, and deletion operations, the maximum number of nodes visited is 47. If you use an AVL tree, the maximum number of nodes visited is  $\log_2 10,000,000 \approx 24$ .

**Key Terms**

- 2-3-4 tree
- 2-4 tree
- 2-node
- 3-node
- 4-node
- B-tree
- fusion operation
- split operation

- transfer operation

## Chapter Summary

1. A 2-4 tree is a completely balanced search tree. In a 2-4 tree, a node may have one, two, or three elements.
2. Searching an element in a 2-4 tree is similar to searching an element in a binary tree. The difference is that you have searched an element within a node.
3. To insert an element to a 2-4 tree, locate a leaf node in which the element will be inserted. If the leaf node is a 2- or 3-node, simply insert the element into the node. If the node is a 4-node, split the node.
4. The process of deleting an element from a 2-4 tree is similar to that of deleting an element from a binary tree. The difference is that you have to perform transfer or fusion operations for empty nodes.
5. The height of a 2-4 tree is  $O(\log n)$ . So, the time complexities for the search, insert, and delete methods are  $O(\log n)$ .
6. A B-tree is a generalization of the 2-4 tree. Each node in a B-tree of order  $d$  can have between  $\lceil d/2 \rceil - 1$  and  $d - 1$  keys except the root. 2-4 trees are flatter than AVL trees and B-trees are flatter than 2-4 trees. B-trees are efficient for creating indexes for data in database systems where large amounts of data are stored on disks.

## Test Questions

Do the test questions for this chapter online at  
[www.cs.armstrong.edu/liang/intro9e/test.html](http://www.cs.armstrong.edu/liang/intro9e/test.html).

## Review Questions

### Sections 47.1-47.2

47.1

What is a 2-4 tree? What are a 2-node, 3-node, and 4-node?

47.2

Describe the data fields in the `Tree24` class and those in the `Tree24Node` class.

47.3

What is the minimum number of elements in a 2-4 tree of height 5? What is the maximum number of elements in a 2-4 tree of height 5?

### Sections 47.3-47.5

47.4

How do you search an element in a 2-4 tree?

47.5

How do you insert an element into a 2-4 tree?

47.6

How do you delete an element from a 2-4 tree?

47.7

Show the change of a 2-4 tree when inserting 1, 2, 3, 4, 10, 9, 7, 5, 8, 6 into it, in this order.

47.8

For the tree built in the preceding question, show the change of the tree after deleting 1, 2, 3, 4, 10, 9, 7, 5, 8, 6 from it in this order.

47.9

Show the change of a B-tree of order 6 when inserting 1, 2, 3, 4, 10, 9, 7, 5, 8, 6, 17, 25, 18, 26, 14, 52, 63, 74, 80, 19, 27 into it, in this order.

47.10

For the tree built in the preceding question, show the change of the tree after deleting 1, 2, 3, 4, 10, 9, 7, 5, 8, 6 from it, in this order.

### Programming Exercises

47.1\*

(Implement inorder) The inorder method in Tree24 is left as an exercise. Implement it.

47.2

(Implement postorder) The postorder method in Tree24 is left as an exercise. Implement it.

47.3

(Implement iterator) The iterator method in Tree24 is left as an exercise. Implement it to iterate the elements using inorder.

47.4\*

(Display a 2-4 tree graphically) Write an applet that displays a 2-4 tree.

47.5\*\*\*

(2-4 tree animation) Write a Java applet that animates the 2-4 tree insert, delete, and search methods, as shown in Figure 47.4.

47.6\*\*

(Parent reference for Tree24) Redefine Tree24Node to add a reference to a node's parent, as shown below:

Tree24Node<E>	
elements: ArrayList<E>	An array list for storing the elements.
child: ArrayList<Tree24Node<E>>	An array list for storing the links to the child nodes.
parent: Tree24Node<E>	Refers to the parent of this node.
+Tree24()	Creates an empty tree node.
+Tree24(o: E)	Creates a tree node with an initial element.

Add the following two new methods in Tree24:

```
public Tree24Node<E> getParent(Tree24Node<E> node)
```

Returns the parent for the specified node.

```
public ArrayList<Tree24Node<E>> getPath(Tree24Node<E> node)
```

Returns the path from the specified node to the root in an array list.

Write a test program that adds numbers 1, 2, ..., 100 to the tree and displays the paths for all leaf nodes.

47.7\*\*\*

(The BTree class) Design and implement a class for B-trees.

*\*\*\*This is a bonus Web chapter*

## CHAPTER 48

### Red-Black Trees

#### Objectives

- To know what a red-black tree is (§48.1).
- To convert a red-black tree to a 2-4 tree and vice versa (§48.2).
- To design the RBT class that extends the BinaryTree class (§48.3).
- To insert an element in a red-black tree and resolve the double-red violation if necessary (§48.4).
- To delete an element from a red-black tree and resolve the double-black problem if necessary (§48.5).
- To implement and test the RBT class (§§48.6-48.7).
- To compare the performance of AVL trees, 2-4 trees, and RBT (§48.8).

## 48.1 Introduction

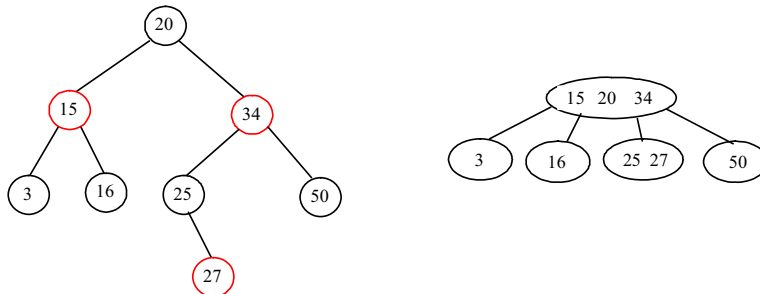
<margin note: derived from 2-4>

<margin note: color attribute>

<margin note: external>

<margin note: black depth>

A red-black tree is a binary search tree derived from a 2-4 tree. A red-black tree corresponds to a 2-4 tree. Each node in a red-black tree has a *color attribute* red or black, as shown in Figure 48.1(a). A node is called *external* if its left or right subtree is empty. Note that a leaf node is external, but an external node is not necessarily a leaf node. For example, node 25 is external, but it is not a leaf. The *black depth* of a node is defined as the number of black nodes in a path from the node to the root. For example, the black depth of node 25 is 2 and that of node 27 is 2.



(a) A red-black tree

(b) A 2-4 tree

**Figure 48.1**

*A red-black tree can be represented using a 2-4 tree, and vice versa.*

NOTE: The red nodes appear in blue in the text.

A red-black tree has the following properties:

1. The root is black.
2. Two adjacent nodes cannot be both red.
3. All external nodes have the same black depth.

The red-black tree in Figure 48.1(a) satisfies all three properties. A red-black tree can be converted to a 2-4 tree, and vice versa. Figure 48.1(b) shows an equivalent 2-4 tree for the red-black tree in Figure 48.1(a).

## 48.2 Conversion between Red-Black Trees and 2-4 Trees

You can design insertion and deletion algorithms for red-black trees without having knowledge of 2-4 trees. However, the correspondence between red-black trees and 2-4 trees provides useful intuition about the structure of red-black trees and operations. For this reason, this section discusses the correspondence between these two types of trees.

<margin note: red-black to 2-4>

To convert a red-black tree to a 2-4 tree, simply merge every red node with its parent to create a 3-node or a 4-node. For example, the red nodes 15 and 34 are merged to their parent to create a 4-node, and the

red node  $27$  is merged to its parent to create a 3-node, as shown in Figure 48.1(b).

**<margin note: 2-4 to red-black>**

To convert a 2-4 tree to a red-black tree, perform the following transformations for each node  $u$ :

**<margin note: converting 2-node>**

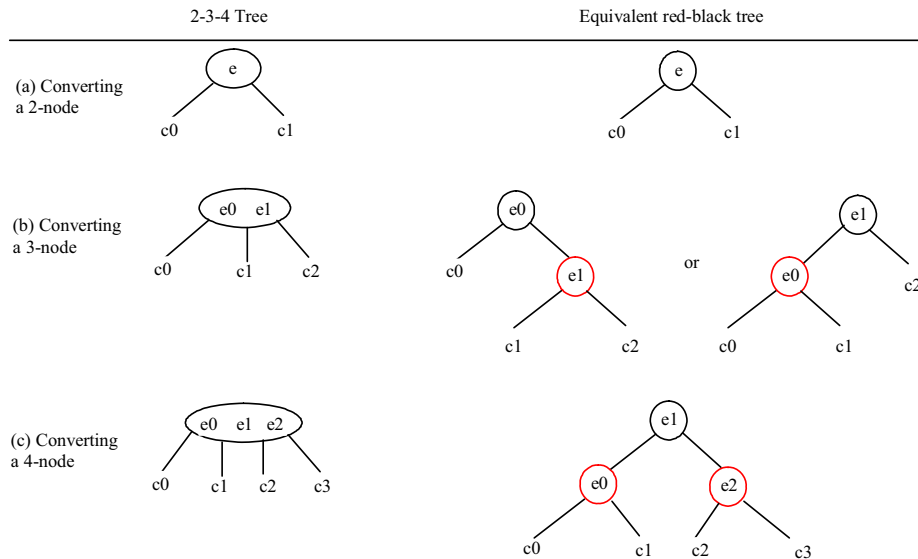
1. If  $u$  is a 2-node, color it black, as shown in Figure 48.2(a).

**<margin note: converting 3-node>**

2. If  $u$  is a 3-node with element values  $e_0$  and  $e_1$ , there are two ways to convert it. Either make  $e_0$  the parent of  $e_1$  or make  $e_1$  the parent of  $e_0$ . In any case, color the parent black and the child red, as shown in Figure 48.2(b).

**<margin note: converting 4-node>**

3. If  $u$  is a 4-node with element values  $e_0, e_1,$  and  $e_2$ , make  $e_1$  the parent of  $e_0$  and  $e_2$ . Color  $e_1$  black and  $e_0$  and  $e_2$  red, as shown in Figure 48.2(c).

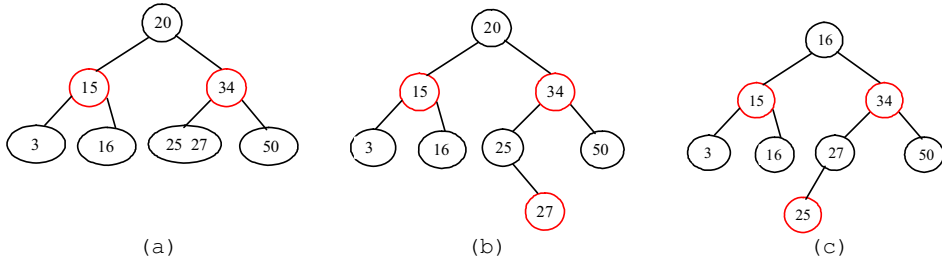


**Figure 48.2**

*A node in a 2-4 tree can be transformed to nodes in a red-black tree.*

**<margin note: not unique>**

Let us apply the transformation for the 2-4 tree in Figure 48.1(b). After transforming the 4-node, the tree is as shown in Figure 48.3(a). After transforming the 3-node, the tree is as shown in Figure 48.3(b). Note that the transformation for a 3-node is not unique. Therefore, the conversion from a 2-4 tree to a red-black tree is *not unique*. After transforming the 3-node, the tree could also be as shown in Figure 48.3(c).



**Figure 48.3**  
*The conversion from a 2-4 tree to a red-black tree is not unique.*

You can prove that the conversion results in a red-black tree that satisfies all three properties.

**<margin note: Property 1 proof>**

**Property 1.** The root is black.

**Proof:** If the root of a 2-4 tree is a 2-node, the root of the red-black tree is black. If the root of a 2-4 tree is a 3-node or 4-node, the transformation produces a black parent at the root.

**<margin note: Property 2 proof>**

**Property 2.** Two adjacent nodes cannot be both red.

**Proof:** Since the parent of a red node is always black, no two adjacent nodes can be both red.

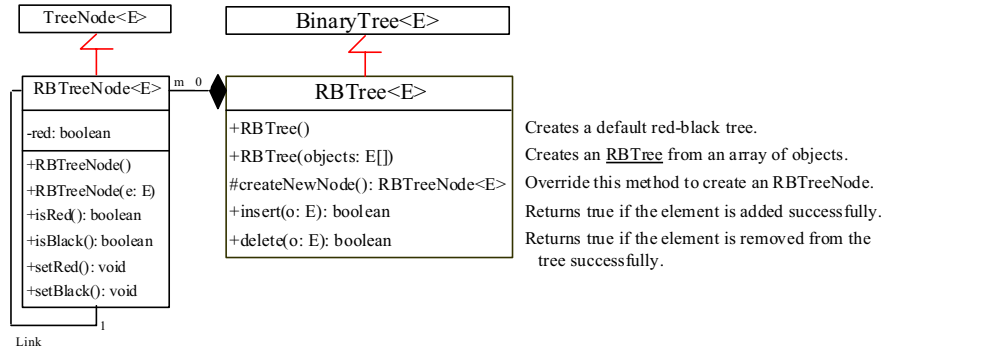
**<margin note: Property 3 proof>**

**Property 3.** All external nodes have the same black depth.

**Proof:** When you convert a node in a 2-4 tree to red-black tree nodes, you get one black node and zero, one, or two red nodes as its children, depending on whether the original node is a 2-, 3-, or 4-node. Only a leaf 2-4 node may produce external red-black nodes. Since a 2-4 tree is perfectly balanced, the number of black nodes in any path from the root to an external node is the same.

**48.3 Designing Classes for Red-Black Trees**

A red-black tree is a binary search tree. So, you can define the `RBTree` class to extend the `BinaryTree` class, as shown in Figure 48.4. The `BinaryTree` and `TreeNode` classes are defined in §26.2.5.



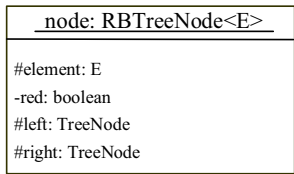


**Figure 48.4**

The `RBTREE` class extends `BINARYTREE` with new implementations for the `insert` and `delete` methods.

**<margin note: RBTREENode>**

Each node in a red-black tree has a color property. Because the color is either red or black, it is efficient to use the `boolean` type to denote it. The `RBTREENode` class can be defined to extend `BINARYTREE.TreeNode` with the color property. For convenience, we also provide the methods for checking the color and setting a new color. Note that `TreeNode` is defined as a static inner class in `BINARYTREE`. `RBTREENode` will be defined as a static inner class in `RBTREE`. Note that `BINARYTREENode` contains the data fields `element`, `left`, and `right`, which are inherited in `RBTREENode`. So, `RBTREENode` contains four data fields, as pictured in Figure 48.5.

**Figure 48.5**

An `RBTREENode` contains data fields `element`, `red`, `left`, and `right`.

**<margin note: createNewNode()>**

In the `BINARYTREE` class, the `createNewNode()` method creates a `TreeNode` object. This method is overridden in the `RBTREE` class to create an `RBTREENode`. Note that the return type of the `createNewNode()` method in the `BINARYTREE` class is `TreeNode`, but the return type of the `createNewNode()` method in `RBTREE` class is `RBTREENode`. This is fine, since `RBTREENode` is a subtype of `TreeNode`.

Searching an element in a red-black tree is the same as searching in a regular binary search tree. So, the `search` method defined in the `BINARYTREE` class also works for `RBTREE`.

The `insert` and `delete` methods are overridden to insert and delete an element and perform operations for coloring and restructuring if necessary to ensure that the three properties of the red-black tree are satisfied.

Pedagogical NOTE

**<side remark: Red-Black tree animation>**

Run from  
[www.cs.armstrong.edu/liang/animation/RBTREEAnimation.html](http://www.cs.armstrong.edu/liang/animation/RBTREEAnimation.html)  
 to see how a red-black tree works, as shown in Figure 48.6.

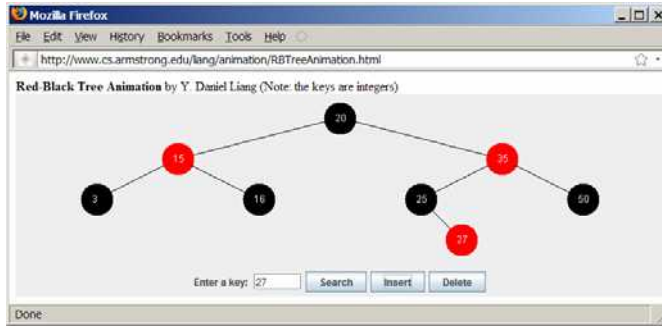


Figure 48.6

The animation tool enables you to insert, delete, and search elements in a red-black tree visually.

\*\*\*End NOTE

#### 48.4 Overriding the `insert` Method

*<margin note: double red>*

A new element is always inserted as a leaf node. If the new node is the root, color it black. Otherwise, color it red. If the parent of the new node is red, it violates Property 2 of the red-black tree. We call this a *double-red* violation.

Let  $u$  denote the new node inserted,  $v$  the parent of  $u$ ,  $w$  the parent of  $v$ , and  $x$  the sibling of  $v$ . To fix the double-red violation, consider two cases:

Case 1:  $x$  is black or  $x$  is null. There are four possible configurations for  $u$ ,  $v$ ,  $w$ , and  $x$ , as shown in Figures 48.7(a), 48.8(a), 48.9(a), and 48.10(a). In this case,  $u$ ,  $v$ , and  $w$  form a 4-node in the corresponding 2-4 tree, as shown in Figures 48.7(c), 48.8(c), 48.9(c), and 48.10(c), but are represented incorrectly in the red-black tree. To correct this error, restructure and recolor three nodes  $u$ ,  $v$ , and  $w$ , as shown in Figures 48.7(b), 48.8(b), 48.9(b), and 48.10(b). Note that  $x$ ,  $y_1$ ,  $y_2$ , and  $y_3$  may be null.

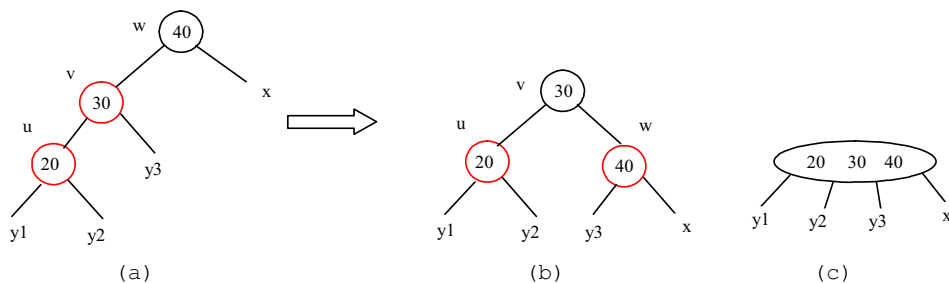
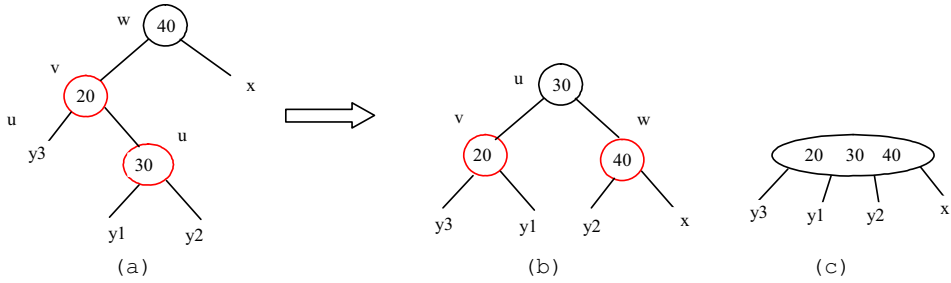


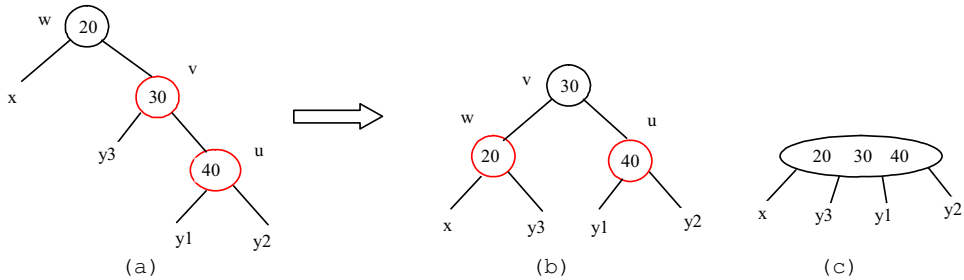
Figure 48.7

Case 1.1:  $u < v < w$ .



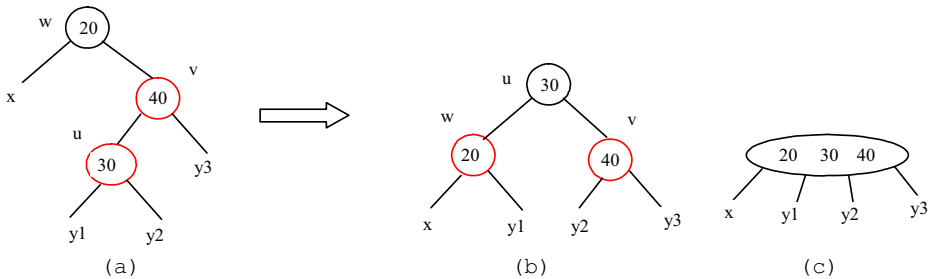
**Figure 48.8**

Case 1.2:  $v < u < w$



**Figure 48.9**

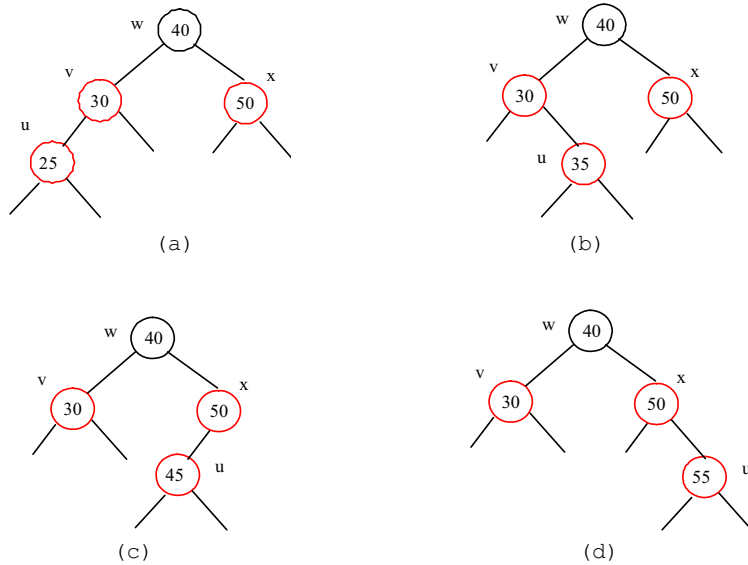
Case 1.3:  $w < v < u$



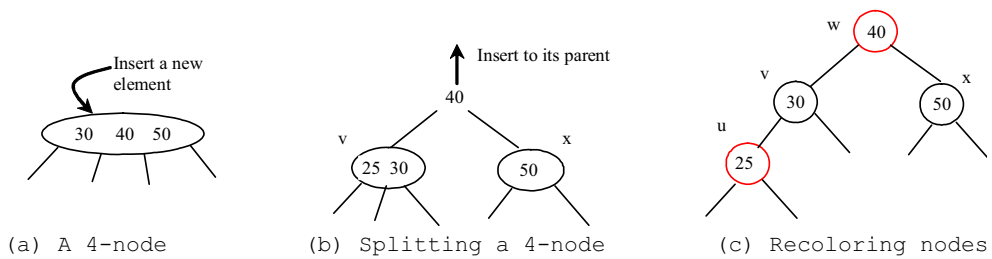
**Figure 48.10**

Case 1.4:  $w < u < v$

Case 2:  $x$  is red. There are four possible configurations for  $u$ ,  $v$ ,  $w$ , and  $x$ , as shown in Figures 48.11(a), 48.11(b), 48.11(c), and 48.11(d). All of these configurations correspond to an overflow situation in the corresponding 4-node in a 2-4 tree, as shown in Figure 48.12(a). A splitting operation is performed to fix the overflow problem in a 2-4 tree, as shown in Figure 48.12(b). We perform an equivalent recoloring operation to fix the problem in a red-black tree. Color  $w$  and  $u$  red and color two children of  $w$  black. Assume  $u$  is a left child of  $v$ , as shown in Figure 48.11(a). After recoloring, the nodes are shown in Figure 48.12(c). Now  $w$  is red, if  $w$ 's parent is black, the double-red violation is fixed. Otherwise, a new double-red violation occurs at node  $w$ . We need to continue the same process to eliminate the double-red violation at  $w$ , recursively.



**Figure 48.11**  
Case 2 has four possible configurations.



**Figure 48.12**  
Splitting a 4-node corresponds to recoloring the nodes in the red-black tree.

A more detailed algorithm for inserting an element is described in Listing 48.1.

**Listing 48.1 Inserting an Element to a Red-Black Tree**

```

<margin note line 1: insert to tree>
<margin note line 2: invoke super.insert>
<margin note line 4: duplicate element>
<margin note line 6: ensure color and depth>

<margin note line 13: ensure color and depth>
<margin note line 14: get path>
<margin note line 15: node index>
<margin note line 16: get u, v>
<margin note line 20: u is root?>
<margin note line 22: double-red violation>

<margin note line 27: fix double red>

```

<margin note line 29: get  $w$ >  
 <margin note line 32: get  $x$ >  
 <margin note line 36: Case 1>  
 <margin note line 38: Case 1.1>  
 <margin note line 41: Case 1.2>  
 <margin note line 44: Case 1.3>  
 <margin note line 47: Case 1.4>  
 <margin note line 50: Case 2>  
 <margin note line 51: recoloring>  
 <margin note line 54:  $w$  is root?>  
 <margin note line 57: propagate upward>  
 <margin note line 61: fix new double red>

```

public boolean insert(E e) {
 boolean successful = super.insert(e);
 if (!successful)
 return false; // e is already in the tree
 else {
 ensureRBTree(e);
 }

 return true; // e is inserted
}

/** Ensure that the tree is a red-black tree */
private void ensureRBTree(E e) {
 Get the path that leads to element e from the root.
 int i = path.size() - 1; // Index to the current node in the path
 Get u, v from the path. u is the node that contains e and v
 is the parent of u.
 Color u red;

 if (u == root) // If e is inserted as the root, set root black
 u.setBlack();
 else if (v.isRed())
 fixDoubleRed(u, v, path, i); // Fix double-red violation at u
}

/** Fix double-red violation at node u */
private void fixDoubleRed(RBTreeNode<E> u, RBTreeNode<E> v,
 ArrayList<TreeNode<E>> path, int i) {
 Get w from the path. w is the grandparent of u.

 // Get v's sibling named x
 RBTreeNode<E> x = (w.left == v) ?
 (RBTreeNode<E>)(w.right) : (RBTreeNode<E>)(w.left);

 if (x == null || x.isBlack()) {
 // Case 1: v's sibling x is black
 if (w.left == v && v.left == u) {
 // Case 1.1: u < v < w, Restructure and recolor nodes
 }
 else if (w.left == v && v.right == u) {
 // Case 1.2: v < u < w, Restructure and recolor nodes
 }
 else if (w.right == v && v.right == u) {

```

```

 // Case 1.3: w < v < u, Restructure and recolor nodes
 }
 else {
 // Case 1.4: w < u < v, Restructure and recolor nodes
 }
}
else { // Case 2: v's sibling x is red
 Color w and u red
 Color two children of w black.

 if (w is root) {
 Set w black;
 }
 else if (the parent of w is red) {
 // Propagate along the path to fix new double-red violation
 u = w;
 v = parent of w;
 fixDoubleRed(u, v, path, i - 2); // i - 2 propagates upward
 }
}
}
}

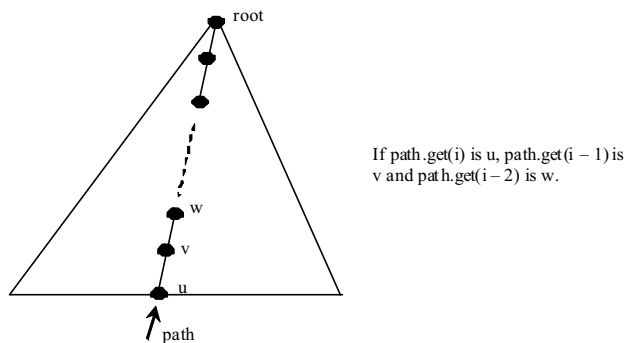
```

**<margin note: insert(E, e)>**

The insert(E e) method (lines 1-10) invokes the insert method in the BinaryTree class to create a new leaf node for the element (line 2). If the element is already in the tree, return false (line 4). Otherwise, invoke ensureRBTree(e) (line 6) to ensure that the tree satisfies the color and black depth property of the red-black tree.

**<margin note: ensureRBTree(E, e)>**

The ensureRBTree(E e) method (lines 13-24) obtains the path that leads to e from the root (line 14), as shown in Figure 48.13. This path plays an important role to implement the algorithm. From this path, you get nodes u and v (lines 16-17). If u is the root, color u black (lines 20-21). If v is red, a double-red violation occurs at node u. Invoke fixDoubleRed to fix the problem.



**Figure 48.13**

The path consists of the nodes from u to the root.

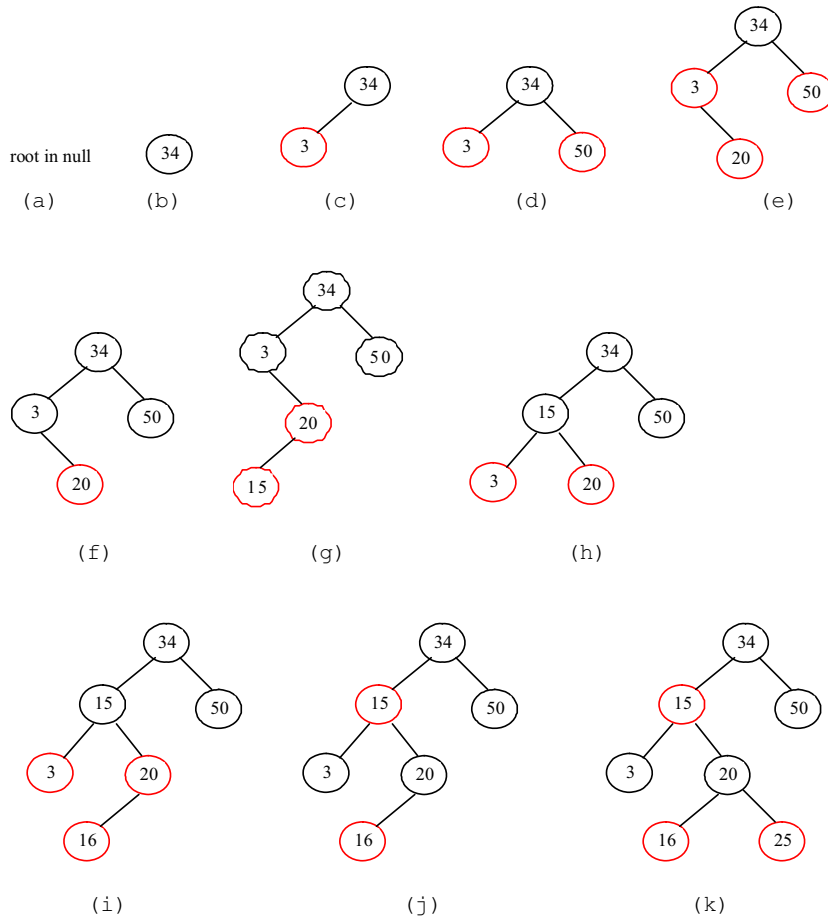
**<margin note: fixDoubleRed>**

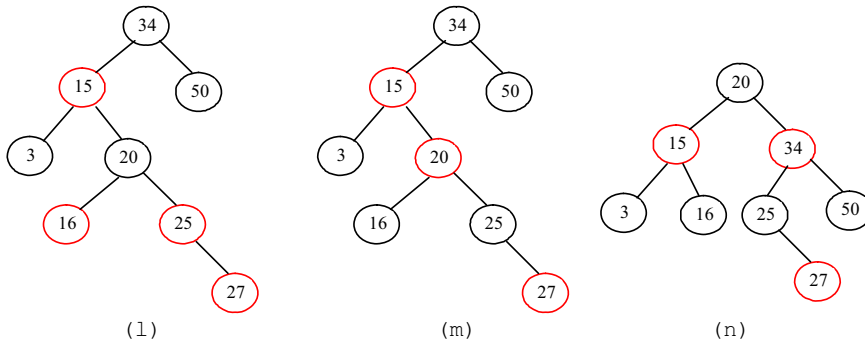
The fixDoubleRed method (lines 27-63) fixes the double-red violation. It first obtains w (the parent of v) from the path (line 29) and x (the

sibling of  $\underline{v}$ ) (lines 32-33). If  $\underline{x}$  is empty or a black node, restructure and recolor three nodes  $\underline{u}$ ,  $\underline{v}$ , and  $\underline{w}$  to eliminate the problem (lines 35-49). If  $\underline{x}$  is a red node, recolor the nodes  $\underline{u}$ ,  $\underline{v}$ ,  $\underline{w}$  and  $\underline{x}$  (lines 51-52). If  $\underline{w}$  is the root, color  $\underline{w}$  black (lines 54-56). If the parent of  $\underline{w}$  is red, the double-red violation reappears at  $\underline{w}$ . Invoke `fixDoubleRed` with new  $\underline{u}$  and  $\underline{v}$  to fix the problem (line 61). Note that now  $\underline{i} - 2$  points to the new  $\underline{u}$  in the path. This adjustment is necessary to locate the new nodes  $\underline{w}$  and parent of  $\underline{w}$  along the path.

**<margin note: insertion example>**

Figure 48.14 shows the steps of inserting 34, 3, 50, 20, 15, 16, 25, and 27 into an empty red-black tree. When inserting 20 into the tree in (d), Case 2 applies to recolor 3 and 50 to black. When inserting 15 into the tree in (g), Case 1.4 applies to restructure and recolor nodes 15, 20, and 3. When inserting 16 into the tree in (i), Case 2 applies to recolor nodes 3 and 20 to black and nodes 15 and 16 to red. When inserting 27 into the tree in (l), Case 2 applies to recolor nodes 16 and 25 to black and nodes 20 and 27 to red. Now a new double-red problem occurs at node 20. Apply Case 1.2 to restructure and recolor nodes. The new tree is shown in (n).





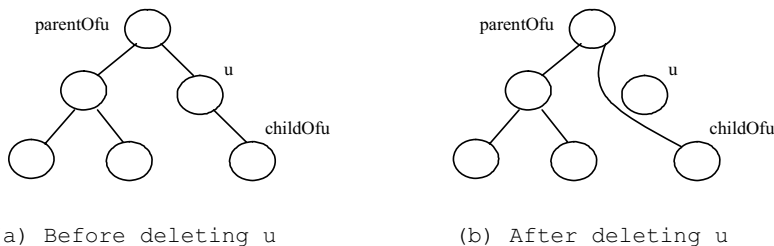
**Figure 48.14**

Inserting into a red-black tree: (a) initial empty tree; (b) inserting 34; (c) inserting 3; (d) inserting 50; (e) inserting 20 causes a double red; (f) after recoloring (Case 2); (g) inserting 15 causes a double red; (h) after restructuring and recoloring (Case 1.4); (i) inserting 16 causes a double red; (j) after recoloring (Case 2); (k) inserting 25; (l) inserting 27 causes a double red at 27; (m) a double red at 20 reappears after recoloring (Case 2); (n) after restructuring and recoloring (Case 1.2).

#### 48.5 Overriding the `delete` Method

To delete an element from a red-black tree, first search the element in the tree to locate the node that contains the element. If the element is not in the tree, the method returns false. Let  $u$  be the node that contains the element. If  $u$  is an internal node with both left and right children, find the rightmost node in the left subtree of  $u$ . Replace the element in  $u$  with the element in the rightmost node. Now we will only consider deleting external nodes.

Let  $u$  be an external node to be deleted. Since  $u$  is an external node, it has at most one child, denoted by `childOfu`. `childOfu` may be `null`. Let `parentOfu` denote the parent of  $u$ , as shown in Figure 48.15(a). Delete  $u$  by connecting `childOfu` with `parentOfu`, as shown in Figure 48.15(b).



**Figure 48.15**

$u$  is an external node and `childOfu` may be `null`.

Consider the following case:

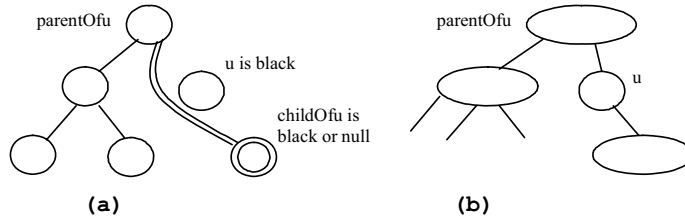
- If  $u$  is red, we are done.



- If  $u$  is black and  $childOfu$  is red, color  $childOfu$  black to maintain the black height for  $childOfu$ .

<margin note: double black>

- Otherwise, assign  $childOfu$  a fictitious double black, as shown in Figure 48.16(a). We call this a double-black problem, which indicates that the black-depth is short by  $\underline{1}$ , caused by deleting a black node  $\underline{u}$ .



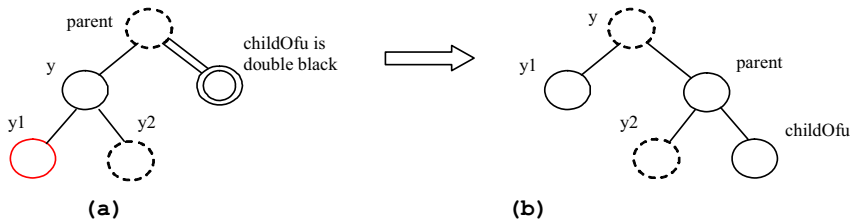
**Figure 48.16**

(a)  $childOfu$  is denoted double black. (b)  $u$  corresponds to an empty node in a 2-4 tree.

A double black in a red-black tree corresponds to an empty node for  $\underline{u}$  (i.e., underflow situation) in the corresponding 2-4 tree, as shown in Figure 48.16(b). To fix the double-black problem, we will perform equivalent transfer and fusion operations. Consider three cases:

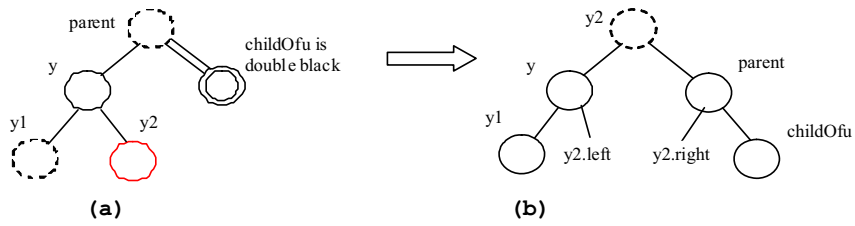
<margin note: Case 1>

**Case 1:** The sibling  $y$  of  $childOfu$  is black and has a red child. This case has four possible configurations, as shown in Figures 48.17(a), 48.18(a), 48.19(a), and 48.20(a). The dashed circle denotes that the node is either red or black. To eliminate the double-black problem, restructure and recolor the nodes, as shown in Figures 48.17(b), 48.18(b), 48.19(b), and 48.20(b).



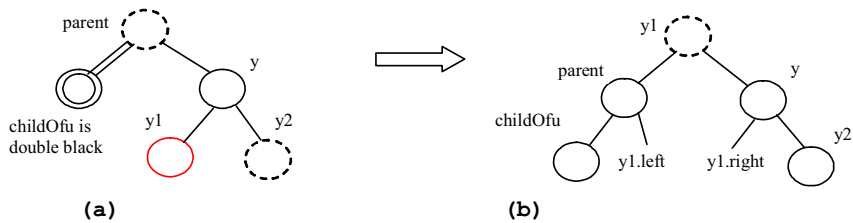
**Figure 48.17**

Case 1.1: The sibling  $y$  of  $childOfu$  is black and  $y1$  is red.



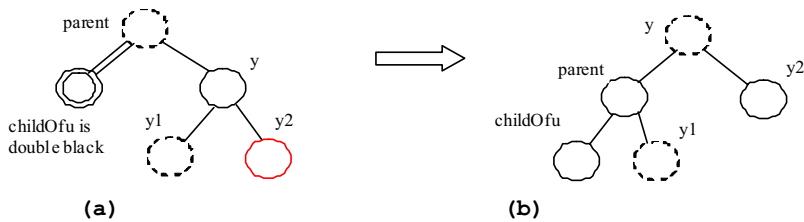
**Figure 48.18**

Case 1.2: The sibling  $y$  of  $\underline{\text{childOfu}}$  is black and  $y_2$  is red.



**Figure 48.19**

Case 1.3: The sibling  $y$  of  $\underline{\text{childOfu}}$  is black and  $y_1$  is red.



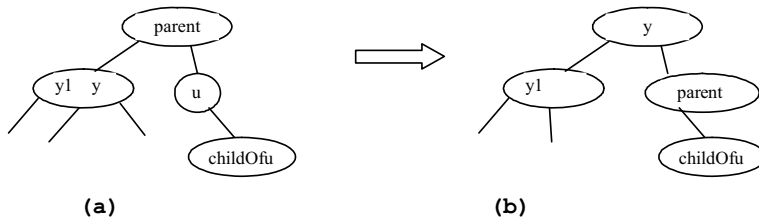
**Figure 48.20**

Case 1.4: the sibling  $y$  of  $\underline{\text{childOfu}}$  is black and  $y_2$  is red.

Note

**<margin note: transfer operation>**

Case 1 corresponds to a *transfer operation* in the 2-4 tree. For example, the corresponding 2-4 tree for Figure 48.17(a) is shown in Figure 48.21(a), and it is transformed into 48.21(b) through a transfer operation.



**Figure 48.21**

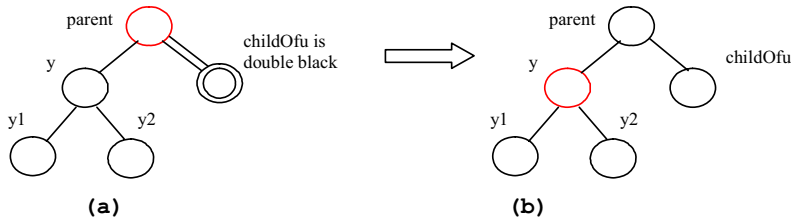
Case 1 corresponds to a transfer operation in the corresponding 2-4 tree.

\*\*\*END of NOTE

<margin note: Case 2>

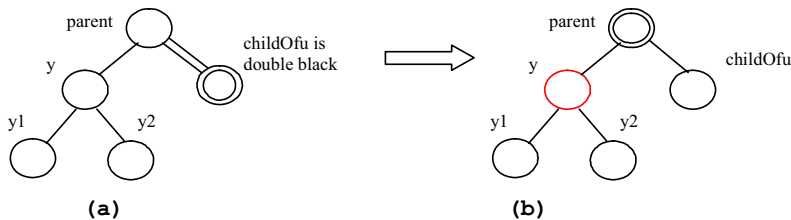
<margin note: propagate>

**Case 2:** The sibling  $\underline{y}$  of  $childOfu$  is black and its children are black or null. In this case, change  $\underline{y}$ 's color to red. If  $\underline{parent}$  is red, change it to black, and we are done, as shown in Figure 48.22. If  $\underline{parent}$  is black, we denote  $\underline{parent}$  double black, as shown in Figure 48.23. The double-black problem propagates to the parent node.



**Figure 48.22**

Case 2: Recoloring eliminates the double-black problem if  $\underline{parent}$  is red.



**Figure 48.23**

Case 2: Recoloring propagates the double-black problem if  $\underline{parent}$  is black.

Note

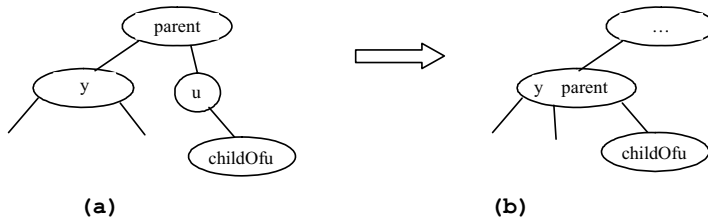
**<margin note: left childOfu>**

Figures 48.22 and 48.22 show that childOfu is a right child of parent. If childOfu is a left child of parent, recoloring is performed identically.

Note

**<margin note: fusion operation>**

Case 2 corresponds to a *fusion* operation in the 2-4 tree. For example, the corresponding 2-4 tree for Figure 48.22(a) is shown in Figure 48.24(a), and it is transformed into 48.24(b) through a fusion operation.



**Figure 48.24**

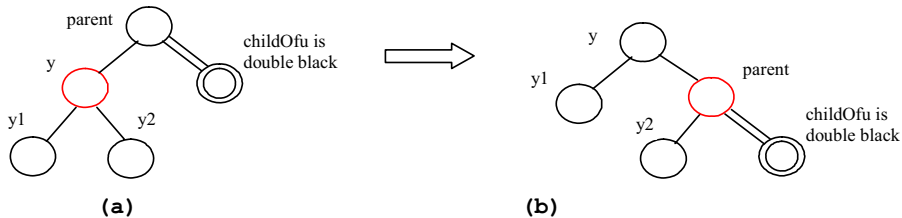
Case 2 corresponds to a fusion operation in the corresponding 2-4 tree.

**\*\*\*END of NOTE**

**<margin note: Case 3>**

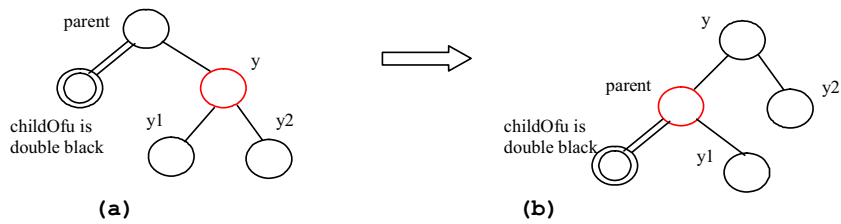
**<margin note: adjustment>**

**Case 3:** The sibling y of childOfu is red. In this case, perform an *adjustment* operation. If y is a left child of parent, let y1 and y2 be the left and right child of y, as shown in Figure 48.25. If y is a right child of parent, let y1 and y2 be the left and right child of y, as shown in Figure 48.26. In both cases, color y black and parent red. childOfu is still a fictitious double-black node. After the adjustment, the sibling of childOfu is now black, and either Case 1 or Case 2 applies. If Case 1 applies, a one-time restructuring and recoloring operation eliminates the double-black problem. If Case 2 applies, the double-black problem cannot reappear, since parent is now red. Therefore, one-time application of Case 1 or Case 2 will complete Case 3.



**Figure 48.25**

Case 3.1: y is a left red child of parent.

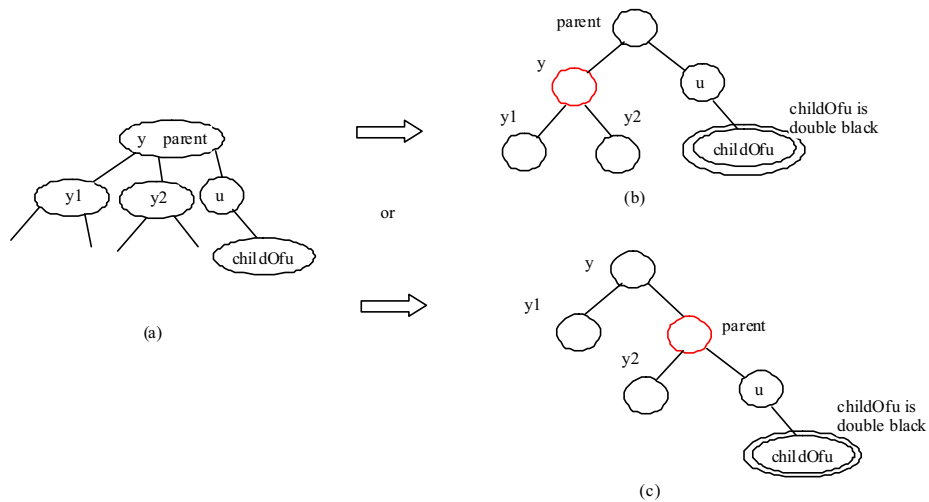


**Figure 48.26**  
Case 3.2:  $y$  is a right red child of  $\underline{\text{parent}}$ .

Note

**<margin note: nonunique transform of 3-node>**

Case 3 results from the fact that a 3-node may be transformed in two ways to a red-black tree, as shown in Figure 48.27.



**Figure 48.27**  
A 3-node may be transformed in two ways to red-black tree nodes.

Based on the foregoing discussion, Listing 48.2 presents a more detailed algorithm for deleting an element.

**Listing 48.2 Deleting an Element from a Red-Black Tree**

- <margin note line 1: delete e from tree>**
- <margin note line 2: locate the node>**
- <margin note line 4: element not found>**
- <margin note line 6: internal element?>**
- <margin note line 7: rightmost node>**
- <margin note line 12: path to external node>**
- <margin note line 15: delete the node>**
- <margin note line 17: one element deleted>**

```

<margin note line 18: deletion successful>

<margin note line 22: delete a node>
<margin note line 23: u>
<margin note line 24: parentOfu, grandparentOfu>
<margin note line 23: childOfu>
<margin note line 26: delete u>
<margin note line 30: done>
<margin note line 32: set childOfu black>
<margin note line 35: fix double black>

<margin note line 39: fix double black>
<margin note line 42: y, y1, y2>
<margin note line 47: process Case 1.1>
<margin note line 51: process Case 1.3>
<margin note line 57: process Case 1.2>
<margin note line 61: process Case 1.4>
<margin note line 66: process Case 2>
<margin note line 77: propagate double black>
<margin note line 83: process Case 3.1>
<margin note line 88: process Case 3.2>
<margin note line 95: fix double black>

```

```

public boolean delete(E e) {
 Locate the node to be deleted
 if (the node is not found)
 return false;

 if (the node is an internal node) {
 Find the rightmost node in the subtree of the node;
 Replace the element in the node with the one in rightmost;
 The rightmost node is the node to be deleted now;
 }

 Obtain the path from the root to the node to be deleted;

 // Delete the last node in the path and propagate if needed
 deleteLastNodeInPath(path);

 size--; // After one element deleted
 return true; // Element deleted
}

/** Delete the last node from the path. */
public void deleteLastNodeInPath(ArrayList<TreeNode<E>> path) {
 Get the last node u in the path;
 Get parentOfu and grandparentOfu in the path;
 Get childOfu from u;
 Delete node u. Connect childOfu with parentOfu

 // Recolor the nodes and fix double black if needed
 if (childOfu == root || u.isRed())
 return; // Done if childOfu is root or if u is red
 else if (childOfu != null && childOfu.isRed())
 childOfu.setBlack(); // Set it black, done
 else // u is black, childOfu is null or black
 // Fix double black on parentOfu

```

```

 fixDoubleBlack(grandparentOfu, parentOfu, childOfu, path, i);
 }

/** Fix the double black problem at node parent */
private void fixDoubleBlack(
 RBTTreeNode<E> grandparent, RBTTreeNode<E> parent,
 RBTTreeNode<E> db, ArrayList<TreeNode<E>> path, int i) {
 Obtain y, y1, and y2

 if (y.isBlack() && y1 != null && y1.isRed()) {
 if (parent.right == db) {
 // Case 1.1: y is a left black sibling and y1 is red
 Restructure and recolor parent, y, and y1 to fix the problem;
 }
 else {
 // Case 1.3: y is a right black sibling and y1 is red
 Restructure and recolor parent, y1, and y to fix the problem;
 }
 }
 else if (y.isBlack() && y2 != null && y2.isRed()) {
 if (parent.right == db) {
 // Case 1.2: y is a left black sibling and y2 is red
 Restructure and recolor parent, y2, and y to fix the problem;
 }
 else {
 // Case 1.4: y is a right black sibling and y2 is red
 Restructure and recolor parent, y, and y2 to fix the problem;
 }
 }
 else if (y.isBlack()) {
 // Case 2: y is black and y's children are black or null
 Recolor y to red;

 if (parent.isRed())
 parent.setBlack(); // Done
 else if (parent != root) {
 // Propagate double black to the parent node
 // Fix new appearance of double black recursively
 db = parent;
 parent = grandparent;
 grandparent =
 (i >= 3) ? (RBTTreeNode<E>)(path.get(i - 3)) : null;
 fixDoubleBlack(grandparent, parent, db, path, i - 1);
 }
 }
 else if (y.isRed()) {
 if (parent.right == db) {
 // Case 3.1: y is a left red child of parent
 parent.left = y;
 y.right = parent;
 }
 else {
 // Case 3.2: y is a right red child of parent
 parent.right = y;
 y.left = parent;
 }
 }
}

```

```

 parent.setRed(); // Color parent red
 y.setBlack(); // Color y black
 connectNewParent(grandparent, parent, y); // y is new parent
 fixDoubleBlack(y, parent, db, path, i - 1);
}
}

```

**<margin note: delete(E, e)>**

The delete(E e) method (lines 1-19) locates the node that contains e (line 2). If the node does not exist, return false (lines 3-4). If the node is an internal node, find the right most node in its left subtree and replace the element in the node with the element in the right most node (lines 6-9). Now the node to be deleted is an external node. Obtain the path from the root to the node (line 12). Invoke deleteLastNodeInPath(path) to delete the last node in the path and ensure that the tree is still a red-black tree (line 15).

**<margin note: deleteLastNodeInPath(path)>**

The deleteLastNodeInPath method (lines 22-36) obtains the last node u, parentOfu, grandparentOfu, and childOfu (lines 23-26). If childOfu is the root or u is red, the tree is fine (lines 29-30). If childOfu is red, color it black (lines 31-32). We are done. Otherwise, u is black and childOfu is null or black. Invoke fixDoubleBlack to eliminate the double-black problem (line 35).

**<margin note: fixDoubleBlack>**

The fixDoubleBlack method (lines 39-97) eliminates the double-black problem. Obtain y, y1, and y2 (line 42). y is the sibling of the double-black node. y1 and y2 are the left and right children of y. Consider three cases:

1. If y is black and one of its children is red, the double-black problem can be fixed by one-time restructuring and recoloring in Case 1 (lines 44-63).
2. If y is black and its children are null or black, change y to red. If parent of y is black, denote parent to be the new double-black node and invoke fixDoubleBlack recursively (line 77).
3. If y is red, adjust the nodes to make parent a child of y (lines 84, 89) and color parent red and y black (lines 92-93). Make y the new parent (line 94). Recursively invoke fixDoubleBlack on the same double-black node with a different color for parent (line 95).

**<margin note: deletion example>**

Figure 48.28 shows the steps of deleting elements. To delete 50 from the tree in Figure 48.28(a), apply Case 1.2, as shown in Figure 48.28(b). After restructuring and recoloring, the new tree is as shown in Figure 48.28(c).

When deleting 20 in Figure 48.28(c), 20 is an internal node, and it is replaced by 16, as shown in Figure 48.28(d). Now Case 2 applies to deleting the rightmost node, as shown in Figure 48.28(e). Recolor the nodes results in a new tree, as shown in Figure 48.28(f).

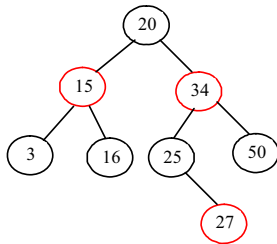
When deleting 15, connect node 3 with node 20 and color node 3 black, as shown in Figure 48.28(g). We are done.



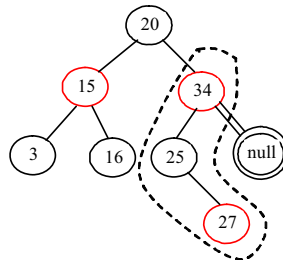
After deleting 25, the new tree is as shown in Figure 48.28(j). Now delete 16. Apply Case 2, as shown in Figure 48.28(k). The new tree is shown in Figure 48.28(l).

After deleting 34, the new tree is as shown in Figure 48.28(m).

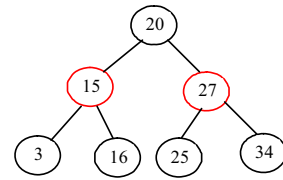
After deleting 27, the new tree is as shown in Figure 48.28(n).



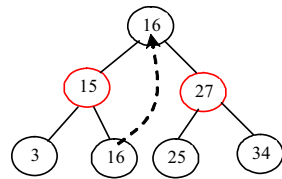
(a) Delete 50



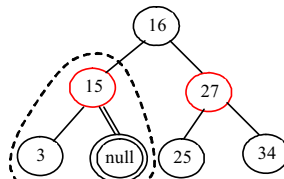
(b) Case 1.2



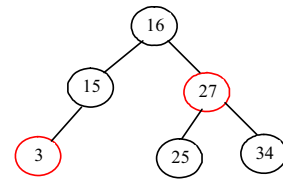
(c) Delete 20



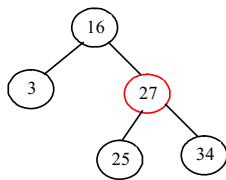
(d) Copy 16 to replace 20



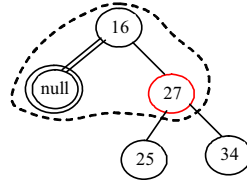
(e) Case 2



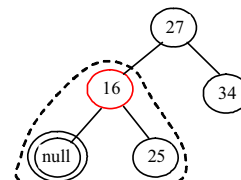
(f) Delete 15



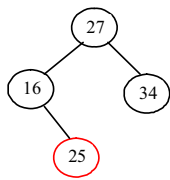
(g) Delete 3



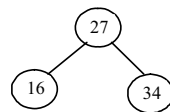
(h) Case 3



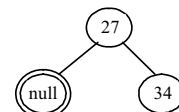
(i) Case 2



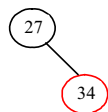
(j) Delete 25



(k) Delete 16



(l) Case 2



(m) Delete 34



(n) Delete 27

root: null

(n) Empty tree

**Figure 48.28**

Delete elements from a red-black tree.

## 48.6 Implementing RBTree Class

Listing 48.3 gives a complete implementation for the RBTree class.

### Listing 48.3 RBTree.java

```
<margin note line 5: no-arg constructor>
<margin note line 9: constructor>
<margin note line 14: create a new node>
<margin note line 19: insert to tree>
<margin note line 20: invoke super.insert>
<margin note line 22: duplicate element>
<margin note line 24: ensure color and depth>

<margin note line 31: ensure color and depth>
<margin note line 33: get path>
<margin note line 35: node index>
<margin note line 38: get u >
<margin note line 41: get v>

<margin note line 46: u is root?>
<margin note line 49: double-red violation>

<margin note line 53: fix double red>
<margin note line 56: get w>
<margin note line 61: get x>
<margin note line 65: Case 1>
<margin note line 66: Case 1.1>
<margin note line 73: Case 1.2>
<margin note line 81: Case 1.3>
<margin note line 87: Case 1.4>
<margin note line 96: Case 2>
<margin note line 98: recoloring>
<margin note line 103: w is root?>
<margin note line 108: propagate upward>
<margin note line 110: fix new double red>

<margin note line 116: restructure/recolor>
<margin note line 133: delete e from tree>
<margin note line 135: locate the node>
<margin note line 147: element not found>
<margin note line 153: internal element?>
<margin note line 155: rightmost node>
<margin note line 160: path to external node>
<margin note line 169: delete the node>
<margin note line 171: one element deleted>
<margin note line 172: deletion successful>

<margin note line 176: delete a node>
<margin note line 179: u>
<margin note line 180: parentOfu>
<margin note line 182: grandparentOfu>
<margin note line 185: childOfu>
<margin note line 189: delete u>
<margin note line 193: done>
```

<margin note line 195: set childOfu black>  
<margin note line 198: fix double black>

<margin note line 202: fix double black>  
<margin note line 206: y, y1, y2>  
<margin note line 212: process Case 1.1>  
<margin note line 221: process Case 1.3>  
<margin note line 234: process Case 1.2>  
<margin note line 245: process Case 1.4>  
<margin note line 255: process Case 2>  
<margin note line 263: propagate double black>  
<margin note line 271: process Case 3.1>  
<margin note line 276: process Case 3.2>  
<margin note line 285: fix double black>

<margin note line 304: connect to grandParent>  
<margin note line 318: override preorder>  
<margin note line 327: RBTreeNode>

```
import java.util.ArrayList;

public class RBTree<E extends Comparable<E>> extends BinaryTree<E> {
 /** Create a default RB tree */
 public RBTree() {
 }

 /** Create an RB tree from an array of elements */
 public RBTree(E[] elements) {
 super(elements);
 }

 /** Override createNewNode to create an RBTreeNode */
 protected RBTreeNode<E> createNewNode(E e) {
 return new RBTreeNode<E>(e);
 }

 /** Override the insert method to balance the tree if necessary */
 public boolean insert(E e) {
 boolean successful = super.insert(e);
 if (!successful)
 return false; // e is already in the tree
 else {
 ensureRBTree(e);
 }

 return true; // e is inserted
 }

 /** Ensure that the tree is a red-black tree */
 private void ensureRBTree(E e) {
 // Get the path that leads to element e from the root
 ArrayList<TreeNode<E>> path = path(e);

 int i = path.size() - 1; // Index to the current node in the path

 // u is the last node in the path. u contains element e
 RBTreeNode<E> u = (RBTreeNode<E>) (path.get(i));
 }
}
```

```

 // v is the parent of u, if exists
 RBTreeNode<E> v = (u == root) ? null :
 (RBTreeNode<E>)(path.get(i - 1));

 u.setRed(); // It is OK to set u red

 if (u == root) // If e is inserted as the root, set root black
 u.setBlack();
 else if (v.isRed())
 fixDoubleRed(u, v, path, i); // Fix double-red violation at u
 }

 /** Fix double-red violation at node u */
 private void fixDoubleRed(RBTreeNode<E> u, RBTreeNode<E> v,
 ArrayList<TreeNode<E>> path, int i) {
 // w is the grandparent of u
 RBTreeNode<E> w = (RBTreeNode<E>)(path.get(i - 2));
 RBTreeNode<E> parentOfw = (w == root) ? null :
 (RBTreeNode<E>)path.get(i - 3);

 // Get v's sibling named x
 RBTreeNode<E> x = (w.left == v) ?
 (RBTreeNode<E>)(w.right) : (RBTreeNode<E>)(w.left);

 if (x == null || x.isBlack()) {
 // Case 1: v's sibling x is black
 if (w.left == v && v.left == u) {
 // Case 1.1: u < v < w, Restructure and recolor nodes
 restructureRecolor(u, v, w, w, parentOfw);

 w.left = v.right; // v.right is v3 in Figure 48.6
 v.right = w;
 }
 else if (w.left == v && v.right == u) {
 // Case 1.2: v < u < w, Restructure and recolor nodes
 restructureRecolor(v, u, w, w, parentOfw);
 v.right = u.left;
 w.left = u.right;
 u.left = v;
 u.right = w;
 }
 else if (w.right == v && v.right == u) {
 // Case 1.3: w < v < u, Restructure and recolor nodes
 restructureRecolor(w, v, u, w, parentOfw);
 w.right = v.left;
 v.left = w;
 }
 else {
 // Case 1.4: w < u < v, Restructure and recolor nodes
 restructureRecolor(w, u, v, w, parentOfw);
 w.right = u.left;
 v.left = u.right;
 u.left = w;
 u.right = v;
 }
 }
 }
}

```

```

 }
 else { // Case 2: v's sibling x is red
 // Recolor nodes
 w.setRed();
 u.setRed();
 ((RBTreeNode<E>(w.left)).setBlack();
 ((RBTreeNode<E>(w.right)).setBlack();

 if (w == root) {
 w.setBlack();
 }
 else if (((RBTreeNode<E>)parentOfw).isRed()) {
 // Propagate along the path to fix new double-red violation
 u = w;
 v = (RBTreeNode<E>)parentOfw;
 fixDoubleRed(u, v, path, i - 2); // i - 2 propagates upward
 }
 }
}

/** Connect b with parentOfw and recolor a, b, c for a < b < c */
private void restructureRecolor(RBTreeNode<E> a, RBTreeNode<E> b,
 RBTreeNode<E> c, RBTreeNode<E> w, RBTreeNode<E> parentOfw) {
 if (parentOfw == null)
 root = b;
 else if (parentOfw.left == w)
 parentOfw.left = b;
 else
 parentOfw.right = b;

 b.setBlack(); // b becomes the root in the subtree
 a.setRed(); // a becomes the left child of b
 c.setRed(); // c becomes the right child of b
}

/** Delete an element from the RBTree.
 * Return true if the element is deleted successfully
 * Return false if the element is not in the tree */
public boolean delete(E e) {
 // Locate the node to be deleted
 TreeNode<E> current = root;
 while (current != null) {
 if (e.compareTo(current.element) < 0) {
 current = current.left;
 }
 else if (e.compareTo(current.element) > 0) {
 current = current.right;
 }
 else
 break; // Element is in the tree pointed by current
 }

 if (current == null)
 return false; // Element is not in the tree

 java.util.ArrayList<TreeNode<E>> path;

```

```

 // current node is an internal node
 if (current.left != null && current.right != null) {
 // Locate the rightmost node in the left subtree of current
 TreeNode<E> rightMost = current.left;
 while (rightMost.right != null) {
 rightMost = rightMost.right; // Keep going to the right
 }

 path = path(rightMost.element); // Get path before replacement

 // Replace the element in current by the element in rightMost
 current.element = rightMost.element;
 }
 else
 path = path(e); // Get path to current node

 // Delete the last node in the path and propagate if needed
 deleteLastNodeInPath(path);

 size--; // After one element deleted
 return true; // Element deleted
}

/** Delete the last node from the path. */
public void deleteLastNodeInPath(ArrayList<TreeNode<E>> path) {
 int i = path.size() - 1; // Index to the node in the path
 // u is the last node in the path
 RBTreeNode<E> u = (RBTreeNode<E>)(path.get(i));
 RBTreeNode<E> parentOfu = (u == root) ? null :
 (RBTreeNode<E>)(path.get(i - 1));
 RBTreeNode<E> grandparentOfu = (parentOfu == null ||
 parentOfu == root) ? null :
 (RBTreeNode<E>)(path.get(i - 2));
 RBTreeNode<E> childOfu = (u.left == null) ?
 (RBTreeNode<E>)(u.right) : (RBTreeNode<E>)(u.left);

 // Delete node u. Connect childOfu with parentOfu
 connectNewParent(parentOfu, u, childOfu);

 // Recolor the nodes and fix double black if needed
 if (childOfu == root || u.isRed())
 return; // Done if childOfu is root or if u is red
 else if (childOfu != null && childOfu.isRed())
 childOfu.setBlack(); // Set it black, done
 else // u is black, childOfu is null or black
 // Fix double black on parentOfu
 fixDoubleBlack(grandparentOfu, parentOfu, childOfu, path, i);
}

/** Fix the double-black problem at node parent */
private void fixDoubleBlack(
 RBTreeNode<E> grandparent, RBTreeNode<E> parent,
 RBTreeNode<E> db, ArrayList<TreeNode<E>> path, int i) {
 // Obtain y, y1, and y2
 RBTreeNode<E> y = (parent.right == db) ?

```

```

(RBTreeNode<E>(parent.left) : (RBTreeNode<E>(parent.right));
RBTreeNode<E> y1 = (RBTreeNode<E>(y.left));
RBTreeNode<E> y2 = (RBTreeNode<E>(y.right));

if (y.isBlack() && y1 != null && y1.isRed()) {
 if (parent.right == db) {
 // Case 1.1: y is a left black sibling and y1 is red
 connectNewParent(grandparent, parent, y);
 recolor(parent, y, y1); // Adjust colors

 // Adjust child links
 parent.left = y.right;
 y.right = parent;
 }
 else {
 // Case 1.3: y is a right black sibling and y1 is red
 connectNewParent(grandparent, parent, y1);
 recolor(parent, y1, y); // Adjust colors

 // Adjust child links
 parent.right = y1.left;
 y.left = y1.right;
 y1.left = parent;
 y1.right = y;
 }
}
else if (y.isBlack() && y2 != null && y2.isRed()) {
 if (parent.right == db) {
 // Case 1.2: y is a left black sibling and y2 is red
 connectNewParent(grandparent, parent, y2);
 recolor(parent, y2, y); // Adjust colors

 // Adjust child links
 y.right = y2.left;
 parent.left = y2.right;
 y2.left = y;
 y2.right = parent;
 }
 else {
 // Case 1.4: y is a right black sibling and y2 is red
 connectNewParent(grandparent, parent, y);
 recolor(parent, y, y2); // Adjust colors

 // Adjust child links
 y.left = parent;
 parent.right = y1;
 }
}
else if (y.isBlack()) {
 // Case 2: y is black and y's children are black or null
 y.setRed(); // Change y to red
 if (parent.isRed())
 parent.setBlack(); // Done
 else if (parent != root) {
 // Propagate double black to the parent node
 // Fix new appearance of double black recursively

```

```

 db = parent;
 parent = grandparent;
 grandparent =
 (i >= 3) ? (RBTreeNode<E>)(path.get(i - 3)) : null;
 fixDoubleBlack(grandparent, parent, db, path, i - 1);
 }
}
else { // y.isRed()
 if (parent.right == db) {
 // Case 3.1: y is a left red child of parent
 parent.left = y2;
 y.right = parent;
 }
 else {
 // Case 3.2: y is a right red child of parent
 parent.right = y.left;
 y.left = parent;
 }

 parent.setRed(); // Color parent red
 y.setBlack(); // Color y black
 connectNewParent(grandparent, parent, y); // y is new parent
 fixDoubleBlack(y, parent, db, path, i - 1);
}
}

/** Recolor parent, newParent, and c. Case 1 removal */
private void recolor(RBTreeNode<E> parent,
 RBTreeNode<E> newParent, RBTreeNode<E> c) {
 // Retain the parent's color for newParent
 if (parent.isRed())
 newParent.setRed();
 else
 newParent.setBlack();

 // c and parent become the children of newParent; set them black
 parent.setBlack();
 c.setBlack();
}

/** Connect newParent with grandParent */
private void connectNewParent(RBTreeNode<E> grandparent,
 RBTreeNode<E> parent, RBTreeNode<E> newParent) {
 if (parent == root) {
 root = newParent;
 if (root != null)
 newParent.setBlack();
 }
 else if (grandparent.left == parent)
 grandparent.left = newParent;
 else
 grandparent.right = newParent;
}

/** Preorder traversal from a subtree */
protected void preorder(TreeNode<E> root) {

```



```

 if (root == null) return;
 System.out.print(root.element +
 (((RBTreeNode<E>)root).isRed() ? " (red) " : " (black) "));
 preorder(root.left);
 preorder(root.right);
 }

 /** RBTreeNode is TreeNode plus color indicator */
 protected static class RBTreeNode<E> extends Comparable<E>> extends
 BinaryTree.TreeNode<E> {
 private boolean red = true; // Indicate node color

 public RBTreeNode(E e) {
 super(e);
 }

 public boolean isRed() {
 return red;
 }

 public boolean isBlack() {
 return !red;
 }

 public void setBlack() {
 red = false;
 }

 public void setRed() {
 red = true;
 }

 int blackHeight;
 }
}

```

**<margin note: constructors>**

The `RBTree` class extends `BinaryTree`. Like the `BinaryTree` class, the `RBTree` class has a no-arg constructor that constructs an empty `RBTree` (lines 5-6) and a constructor that creates an initial `RBTree` from an array of elements (lines 9-11).

**<margin note: createNewNode()>**

The `createNewNode()` method defined in the `BinaryTree` class creates a `TreeNode`. This method is overridden to return an `RBTreeNode` (lines 14-16). This method is invoked in the `insert` method in `BinaryTree` to create a node.

**<margin note: insert>**

The `insert` method in `RBTree` is overridden in lines 19-28. The method first invokes the `insert` method in `BinaryTree`, then invokes `ensureRBTree(e)` (line 24) to ensure that tree is still a red-black tree after inserting a new element.

**<margin note: ensureRBTree>**

The `ensureRBTree(E e)` method first obtains the path of nodes that lead to element `e` from the root (line 33). It obtains `u` and `v` (the parent of

u) from the path. If u is the root, color u black (lines 46-47). If v is red, invoke fixDoubleRed to fix the double red on both u and v (lines 48-49).

**<margin note: fixDoubleRed>**

The fixDoubleRed(u, v, path, i) method fixes the double-red violation at node u. The method first obtains w (the grandparent of u from the path) (line 56), parentOfw if exists (lines 57-58), and x (the sibling of v) (lines 61-62). If x is null or black, consider four subcases to fix the double-red violation (lines 66-95). If x is red, color w and u red and color w's two children black (lines 100-103). If w is the root, color w black (lines 103-105). Otherwise, propagate along the path to fix the new double-red violation (lines 108-110).

**<margin note: delete>**

The delete(E e) method in RBTree is overridden in lines 133-173. The method locates the node that contains e (lines 135-145). If the node is null, no element is found (lines 147-148). The method considers two cases:

- If the node is internal, find the rightmost node in its left subtree (lines 155-158). Obtain a path from the root to the rightmost node (line 160), and replace the element in the node with the element in the rightmost node (line 163).
- If the node is external, obtain the path from the root to the node (line 166).

The last node in the path is the node to be deleted. Invoke deleteLastNodeInPath(path) to delete it and ensure the tree is a red-black after the node is deleted (line 169).

**<margin note: deleteLastNodeInPath>**

The deleteLastNodeInPath(path) method first obtains u, parentOfu, grandparentOfu, and childOfu (lines 179-186). u is the last node in the path. Connect childOfu as a child of parentOfu (line 189). This in effect deletes u from the tree. Consider three cases:

- If childOfu is the root or childOfu is red, we are done (lines 192-193).
- Otherwise, if childOfu is red, color it black (lines 194-195).
- Otherwise, invoke fixDoubleBlack to fix the double-black problem on childOfu (line 198).

**<margin note: fixDoubleBlack>**

The fixDoubleBlack method first obtains y, y1, and y2 (lines 206-209). y is the sibling of the first double-black node, and y1 and y2 are the left and right children of y. Consider three cases:

- If y is black and y1 or y2 is red, fix the double-black problem for Case 1 (lines 212-254).
- Otherwise, if y is black, fix the double-black problem for Case 2 by recoloring the nodes. If parent is black and not a root, propagate double black to parent and recursively invoke fixDoubleBlack (lines 263-267).

- Otherwise, y is red. In this case, adjust the nodes to make parent the child of y (lines 271-280). Invoke `fixDoubleBlack` with the adjusted nodes (line 285) to fix the double-black problem.

*<margin note: preorder>*

The `preorder(TreeNode<E> root)` method is overridden to display the node colors (lines 318-324).

#### 48.7 Testing the `RBTree` Class

Listing 48.4 gives a test program. The program creates an `RBTree` initialized with an array of integers 34, 3, and 50 (lines 4-5), inserts elements in lines 10-22, and deletes elements in lines 25-46.

##### Listing 48.4 TestRBTree.java

*<margin note line 5: create an RBTree>*

*<margin note line 8: insert 20>*

*<margin note line 11: insert 15>*

*<margin note line 14: insert 16>*

*<margin note line 17: insert 25>*

*<margin note line 20: insert 27>*

*<margin note line 23: delete 50>*

*<margin note line 29: delete 15>*

*<margin note line 32: delete 3>*

*<margin note line 35: delete 25>*

*<margin note line 38: delete 16>*

*<margin note line 41: delete 34>*

*<margin note line 44: delete 27>*

```
public class TestRBTree {
 public static void main(String[] args) {
 // Create an RB tree
 RBTree<Integer> tree =
 new RBTree<Integer>(new Integer[]{34, 3, 50});
 printTree(tree);

 tree.insert(20);
 printTree(tree);

 tree.insert(15);
 printTree(tree);

 tree.insert(16);
 printTree(tree);

 tree.insert(25);
 printTree(tree);

 tree.insert(27);
 printTree(tree);

 tree.delete(50);
 printTree(tree);

 tree.delete(20);
 printTree(tree);
 }
}
```

```

 tree.delete(15);
 printTree(tree);

 tree.delete(3);
 printTree(tree);

 tree.delete(25);
 printTree(tree);

 tree.delete(16);
 printTree(tree);

 tree.delete(34);
 printTree(tree);

 tree.delete(27);
 printTree(tree);
 }

 public static void printTree(BinaryTree tree) {
 // Traverse tree
 System.out.print("\nInorder (sorted): ");
 tree.inorder();
 System.out.print("\nPostorder: ");
 tree.postorder();
 System.out.print("\nPreorder: ");
 tree.preorder();
 System.out.print("\nThe number of nodes is " + tree.getSize());
 System.out.println();
 }
}

```

#### <Output>

Inorder (sorted): 3 34 50

Postorder: 3 50 34

Preorder: 34 (black) 3 (red) 50 (red)

The number of nodes is 3

Inorder (sorted): 3 20 34 50

Postorder: 20 3 50 34

Preorder: 34 (black) 3 (black) 20 (red) 50 (black)

The number of nodes is 4

Inorder (sorted): 3 15 20 34 50

Postorder: 3 20 15 50 34

Preorder: 34 (black) 15 (black) 3 (red) 20 (red) 50 (black)

The number of nodes is 5

Inorder (sorted): 3 15 16 20 34 50

Postorder: 3 16 20 15 50 34

Preorder: 34 (black) 15 (red) 3 (black) 20 (black) 16 (red) 50 (black)

The number of nodes is 6

Inorder (sorted): 3 15 16 20 25 34 50

Postorder: 3 16 25 20 15 50 34

Preorder: 34 (black) 15 (red) 3 (black) 20 (black) 16 (red) 25 (red)

```

50 (black)
The number of nodes is 7

Inorder (sorted): 3 15 16 20 25 27 34 50
Postorder: 3 16 15 27 25 50 34 20
Preorder: 20 (black) 15 (red) 3 (black) 16 (black) 34 (red) 25 (black)
27 (red) 50 (black)
The number of nodes is 8

Inorder (sorted): 3 15 16 20 25 27 34
Postorder: 3 16 15 25 34 27 20
Preorder: 20 (black) 15 (red) 3 (black) 16 (black) 27 (red)
25 (black) 34 (black)
The number of nodes is 7

Inorder (sorted): 3 15 16 25 27 34
Postorder: 3 15 25 34 27 16
Preorder: 16 (black) 15 (black) 3 (red) 27 (red) 25 (black) 34 (black)
The number of nodes is 6

Inorder (sorted): 3 16 25 27 34
Postorder: 3 25 34 27 16
Preorder: 16 (black) 3 (black) 27 (red) 25 (black) 34 (black)
The number of nodes is 5

Inorder (sorted): 16 25 27 34
Postorder: 25 16 34 27
Preorder: 27 (black) 16 (black) 25 (red) 34 (black)
The number of nodes is 4

Inorder (sorted): 16 27 34
Postorder: 16 34 27
Preorder: 27 (black) 16 (black) 34 (black)
The number of nodes is 3

Inorder (sorted): 27 34
Postorder: 34 27
Preorder: 27 (black) 34 (red)
The number of nodes is 2

Inorder (sorted): 27
Postorder: 27
Preorder: 27 (black)
The number of nodes is 1

Inorder (sorted):
Postorder:
Preorder:
The number of nodes is 0
<End Output>

```

Figure 48.14 shows how the tree evolves as elements are added to it, and Figure 48.28 shows how the tree evolves as elements are deleted from it.

## 48.8 Performance of the `RBTREE` Class

**<margin note:  $2\log n$  height>**

The search, insertion, and deletion times in a red-black tree depend on the height of the tree. A red-black tree corresponds to a 2-4 tree. When you convert a node in a 2-4 tree to red-black tree nodes, you get one black node and zero, one, or two red nodes as its children, depending on whether the original node is a 2-node, 3-node, or 4-node. So, the height of a red-black tree is at most as twice that of its corresponding 2-4 tree. Since the height of a 2-4 tree is  $\log n$ , the height of a red-black tree is  $2\log n$ .

**<margin note: red-black vs. AVL>**

A red-black tree has the same time complexity as an AVL tree, as shown in Table 48.1. In general, a red-black is more efficient than an AVL tree, because a red-black tree requires only one time restructuring of the nodes for insert and delete operations.

**<margin note: red-black vs. 2-4>**

A red-black tree has the same time complexity as a 2-4 tree, as shown in Table 48.1. In general, a red-black is more efficient than a 2-4 tree for two reasons:

1. A red-black tree requires only one-time restructuring of the nodes for insert and delete operations. However, a 2-4 tree may require many splits for an insert operation and fusion for a delete operation.
2. A red-black tree is a binary search tree. A binary tree can be implemented more space efficiently than a 2-4 tree, because a node in a 2-4 tree has at most three elements and four children. Space is wasted for 2-nodes and 3-nodes in a 2-4 tree.

Table 48.1

Time Complexities for Methods in `RBTREE`, `AVLTREE`, and `TREE234`

Methods	Red-Black Tree	AVL Tree	2-4 Tree
search(e: E)	$O(\log n)$	$O(\log n)$	$O(\log n)$
insert(e: E)	$O(\log n)$	$O(\log n)$	$O(\log n)$
delete(e: E)	$O(\log n)$	$O(\log n)$	$O(\log n)$
getSize()	$O(1)$	$O(1)$	$O(1)$
isEmpty()	$O(1)$	$O(1)$	$O(1)$

Listing 48.5 gives an empirical test of the performance of AVL trees, 2-4 trees, and red-black trees.

### Listing 48.5 `TreePerformanceTest.java`

**<margin note line 6: an AVL tree>**  
**<margin note line 11: a 2-4 tree>**  
**<margin note line 16: a red-black tree>**  
**<margin note line 21: start time>**  
**<margin note line 29: shuffle>**  
**<margin note line 33: add to tree>**

<margin note line 35: shuffle>

<margin note line 39: remove from container>

<margin note line 41: end time>

<margin note line 42: return elapsed time>

```
public class TreePerformanceTest {
 public static void main(String[] args) {
 final int TEST_SIZE = 500000; // Tree size used in the test

 // Create an AVL tree
 Tree<Integer> tree1 = new AVLTree<Integer>();
 System.out.println("AVL tree time: " +
 getTime(tree1, TEST_SIZE) + " milliseconds");

 // Create a 2-4 tree
 Tree<Integer> tree2 = new Tree24<Integer>();
 System.out.println("2-4 tree time: " +
 + getTime(tree2, TEST_SIZE) + " milliseconds");

 // Create a red-black tree
 Tree<Integer> tree3 = new RBTree<Integer>();
 System.out.println("RB tree time: " +
 + getTime(tree3, TEST_SIZE) + " milliseconds");
 }

 public static long getTime(Tree<Integer> tree, int testSize) {
 long startTime = System.currentTimeMillis(); // Start time

 // Create a list to store distinct integers
 java.util.List<Integer> list = new java.util.ArrayList<Integer>();
 for (int i = 0; i < testSize; i++)
 list.add(i);

 java.util.Collections.shuffle(list); // Shuffle the list

 // Insert elements in the list to the tree
 for (int i = 0; i < testSize; i++)
 tree.insert(list.get(i));

 java.util.Collections.shuffle(list); // Shuffle the list

 // Delete elements in the list from the tree
 for (int i = 0; i < testSize; i++)
 tree.delete(list.get(i));

 // Return elapse time
 return System.currentTimeMillis() - startTime;
 }
}
```

<Output>

AVL tree time: 7609 milliseconds

2-4 tree time: 8594 milliseconds

RB tree time: 5515 milliseconds

<End Output>

The `getTestTime` method creates a list of distinct integers from `0` to `testSize - 1` (lines 25-27), shuffles the list (line 29), adds the

elements from the list to a tree (lines 32-33), shuffles the list again (line 35), removes the elements from the tree (lines 38-39), and finally returns the execution time (line 42).

The program creates an AVL (line 6), a 2-4 tree (line 11), and a red-black tree (line 16). The program obtains the execution time for adding and removing 500000 elements in the three trees.

**<margin note: red-black tree best>**

As you see, the red-black tree performs the best, followed by the AVL tree.

NOTE:

**<margin note: java.util.TreeSet>**

The `java.util.TreeSet` class in the Java API is implemented using a red-black tree. Each entry in the set is stored in the tree. Since the `search`, `insert`, and `delete` methods in a red-black tree take  $O(\log n)$  time, the `get`, `add`, `remove`, and `contains` methods in `java.util.TreeSet` take  $O(\log n)$  time.

NOTE:

**<margin note: java.util.TreeMap>**

The `java.util.TreeMap` class in the Java API is implemented using a red-black tree. Each entry in the map is stored in the tree. The order of the entries is determined by their keys. Since the `search`, `insert`, and `delete` methods in a red-black tree take  $O(\log n)$  time, the `get`, `put`, `remove`, and `containsKey` methods in `java.util.TreeMap` take  $O(\log n)$  time.

## Key Terms

- black depth
- double-black violation
- double-red violation
- external node
- red-black tree

## Chapter Summary

1. A red-black tree is a binary search tree, derived from a 2-4 tree. A red-black tree corresponds to a 2-4 tree. You can convert a red-black tree to a 2-4 tree or vice versa.
2. In a red-black tree, each node is colored red or black. The root is always black. Two adjacent nodes cannot be both red. All external nodes have the same black depth.
3. Since a red-black tree is a binary search tree, the `RBTree` class extends the `BinaryTree` class.
4. Searching an element in a red-black tree is the same as in binary search tree, since a red-black tree is a binary search tree.
5. A new element is always inserted as a leaf node. If the new node is the root, color it black. Otherwise, color it red. If the parent of the new node is red, we have to fix the *double-red violation* by reassigning the color and/or restructuring the tree.
6. If a node to be deleted is internal, find the rightmost node in its left subtree. Replace the element in the node with the element in the rightmost node. Delete the rightmost node.



7. If the external node to be deleted is red, simply reconnect the parent node of the external node with the child node of the external node.
8. If the external node to be deleted is black, you need to consider several cases to ensure that black height for external nodes in the tree is maintained correctly.
9. The height of a red-black tree is  $O(\log n)$ . So, the time complexities for the search, insert, and delete methods are  $O(\log n)$ .

### Test Questions

Do the test questions for this chapter online at  
[www.cs.armstrong.edu/liang/intro9e/test.html](http://www.cs.armstrong.edu/liang/intro9e/test.html).

### Review Questions

#### Sections 48.1-48.2

48.1

What is a red-black tree? What is an external node? What is black-depth?

48.2

Describe the properties of a red-black tree.

48.3

How do you convert a red-black tree to a 2-4 tree? Is the conversion unique?

48.4

How do you convert a 2-4 tree to a red-black tree? Is the conversion unique?

#### Sections 48.3-48.5

48.5

What are the data fields in RBTreeNode?

48.6

How do you insert an element into a red-black tree and how do you fix the double-red violation?

48.7

How do you delete an element from a red-black tree and how do you fix the double-black problem?

48.8

Show the change of the tree when inserting 1, 2, 3, 4, 10, 9, 7, 5, 8, 6 into it, in this order.

48.9

For the tree built in the preceding question, show the change of the tree after deleting 1, 2, 3, 4, 10, 9, 7, 5, 8, 6 from it in this order.

### Programming Exercises

48.1\*

(red-black tree to 2-4 tree) Write a program that converts a red-black tree to a 2-4 tree.

48.2\*

(2-4 tree to red-black tree) Write a program that converts a red-black tree to a 2-4 tree.

48.3\*\*\*

(red-black tree animation) Write a Java applet that animates the red-black tree insert, delete, and search methods, as shown in Figure 48.6.

48.4\*\*

(Parent reference for RBT) Suppose that the TreeNode class defined in BinaryTree contains a reference to the node's parent, as shown in Exercise 26.17. Implement the RBT class to support this change. Write a test program that adds numbers 1, 2, ..., 100 to the tree and displays the paths for all leaf nodes.

*\*\*\*This is a bonus Web chapter*

## CHAPTER 49

### Java 2D

#### Objectives

- To obtain a Graphics2D object for rendering Java 2D shapes (§49.2).
- To use geometric models to separate modeling of shapes from rendering (§49.3).
- To know the hierarchy of shapes (§49.3).
- To model lines, rectangles, ellipses, arcs using Line2D, Rectangle2D, RoundRectangle2D, Ellipse2D, and Arc2D (§49.4).
- To perform coordinate transformation using the translate, rotate, and scale methods (§49.5).
- To specify the attributes of lines using the BasicStroke class (§49.6).
- To define a varying color using GradientPaint and define an image paint using TexturePaint (§49.7).
- To model quadratic curves and cubic curves using the QuadCurve2D and CubicCurve2D classes (§49.8).
- To model an arbitrary geometric path using Path2D and to define interior points using the WIND\_EVEN\_ODD and WIND\_NON\_ZERO rules (§49.9).
- To perform constructive area geometry using the Area class (§49.10).

## 49.1 Introduction

Using the methods in the Graphics class, you learned how to draw lines, rectangles, ovals, arcs, and polygons. This chapter introduces Java 2D, which enables you to draw advanced and complex two-dimensional graphics.

NOTE:

This chapter introduces the basic and commonly used features in Java 2D. For a complete coverage of Java 2D, please see *Computer Graphics Using Java 2D and 3D* by Hong Zhang and Y. Daniel Liang, published by Prentice Hall.

## 49.2 Obtaining a Graphics2D Object

You used the drawing methods in the Graphics class in the text. The Graphics class is primitive. The Java 2D API provides the java.awt.Graphics2D class, which extends java.awt.Graphics with advanced capabilities for rendering graphics. Normally, you write the code to draw graphics in the paintComponent method in a GUI component. The coding template for the method is as follows:

```
protected void paintComponent(Graphics g) {
 super.paintComponent(g);

 // Use the method in Graphics to draw graphics
 ...
}
```

The parameter passed to the paintComponent method is actually an instance of Graphics2D. So, to obtain a Graphics2D reference, you may simply cast the parameter g to Graphics2D as follows:

```
protected void paintComponent(Graphics g) {
 super.paintComponent(g);

 Graphics2D g2d = (Graphics2D)g; // Get a Graphics2D object

 // Use the method in Graphics2D to draw graphics
 ...
}
```

Since Graphics2D is a subclass of Graphics, all the methods in Graphics can be used in Graphics2D. Additionally, you can use the methods in Graphics2D.

## 49.3 Geometric Models

You have used the methods in the Graphics class to draw lines, rectangles, arcs, ellipses, and polygons. The Java 2D API uses the model-view controller architecture to separate rendering from modeling. This approach enables you to create shapes and perform manipulations, such as transforming and rotating, to combine shapes using models, and to use Graphics2D to render shapes.

Java 2D provides facilities to construct basic shapes and to combine them to form more complex shapes. Figure 49.1 shows various shapes supported in Java 2D.

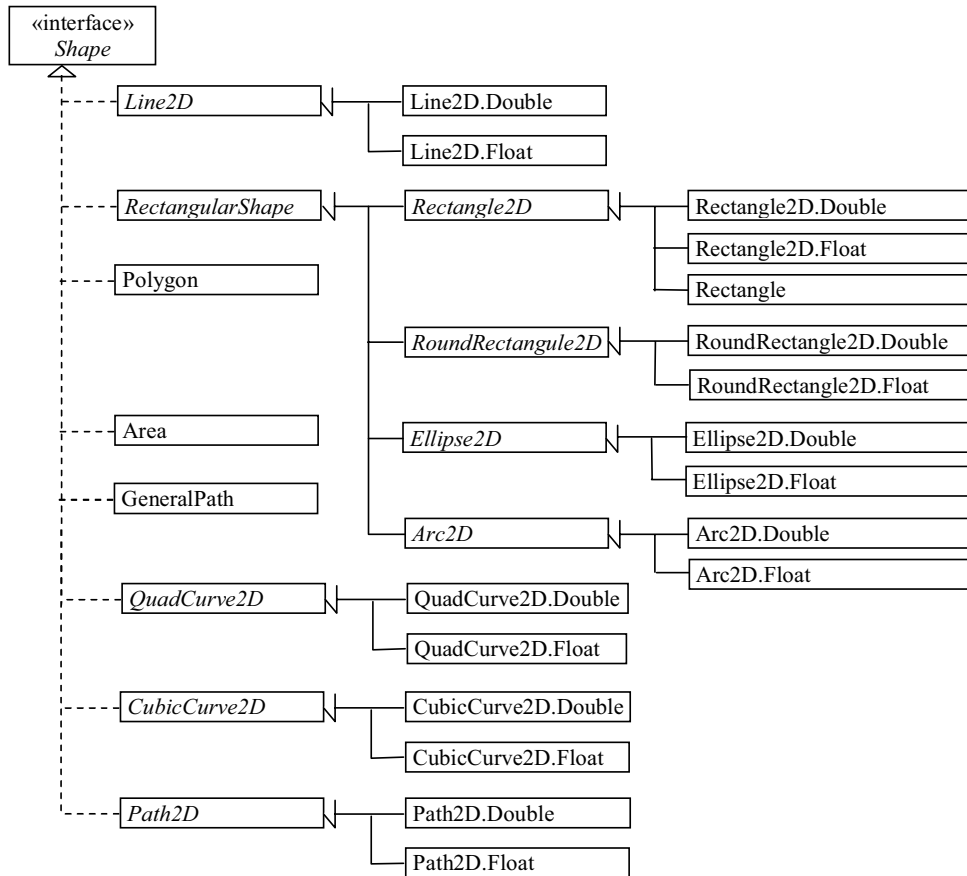


Figure 49.1

Java 2D defines various shapes.

**<Side remark: methods in Shape>**

The Shape interface defines the common features for shapes and provides the contains method to test whether a point or a rectangle is inside a shape, and the intersects method to test whether the shape overlaps with a rectangle, as shown in Figure 49.2. These methods are often useful in geometrical programming.

«interface» <i>java.awt.Shape</i>	
+contains(x: double, y: double): boolean	Tests whether the specified coordinates are inside the shape.
+contains(x: double, y: double, w: double, h: double): boolean	Tests whether the specified rectangle with upper-left corner (x, y), width w and height h is inside the shape.
+contains(p: Point2D): boolean	Tests whether a specified Point2D is inside the shape.
+contains(r: Rectangle2D): boolean	Tests whether a specified Rectangle2D is inside the shape.
+intersects(x: double, y: double, w: double, h: double): boolean	Tests whether the specified rectangle with upper-left corner (x, y), width w and height h intersects this shape.
+intersects(r: Rectangle2D): boolean	Tests whether a specified Rectangle2D intersects this shape.
+getBounds2D(): Rectangle2D	Returns a bounding rectangle that encloses the shape.

Figure 49.2

*Shape* is the root interface for all Java 2D shapes.

**<Side remark: concrete shape classes>**

Classes Line2D, Rectangle2D, RoundRectangle2D, Arc2D, Ellipse2D, QuadCurve2D, CubicCurve2D, and Path2D are abstract classes. Each contains two concrete static inner classes named Double and Float for double and float coordinates, respectively. For example, Line2D.Double refers to the static inner class Double defined in the Line2D class. You can use either Line2D.Double or Line2D.Float to create an object for modeling a line, depending on whether you want to use double or float for coordinates. These inner classes are also subclasses of their respective outer classes. So Line2D.Double is a subclass of Line2D.

**<Side remark: Point2D>**

A point can be modeled using the abstract Point2D class. It contains two concrete static inner classes Point2D.Double and Point2D.Float for double and float coordinates, respectively. Point2D.Double and Point2D.Float are also subclasses of Point2D. The Point class was introduced in JDK 1.1 and now is included in Java 2D for backward compatibility. Point is now defined as a subclass of Point2D. Point2D contains the methods for finding the distance between two points.

**<Side remark: create a shape>**

To create a shape, use the constructor of a concrete shape class. For example, to model a line from (x<sub>1</sub>, y<sub>1</sub>) to (x<sub>2</sub>, y<sub>2</sub>), you may create a Line2D object with double data type using the following constructor:

**<Side remark: create a line>**

```
Line2D line = new Line2D.Double(x1, y1, x2, y2);
```

The Graphics2D class contains the draw(Shape s) method to draw the boundary of the shape and the fill(Shape s) method to fill the interior of the shape. To render the line on a GUI component, use

**<Side remark: render a line>**

```
g2d.draw(line);
```

where g2d is a Graphics2D object for the GUI component.

**49.4 Rectangle2D, RoundRectangle2D, Arc2D, and Ellipse2D**

**<Side remark: RectangularShape>**

RectangularShape is an abstract base class for Rectangle2D, RoundRectangle2D, Arc2D, and Ellipse2D, whose geometry is defined by a

rectangular frame. Figure 49.3 shows the UML diagram for `RectangularShape`.

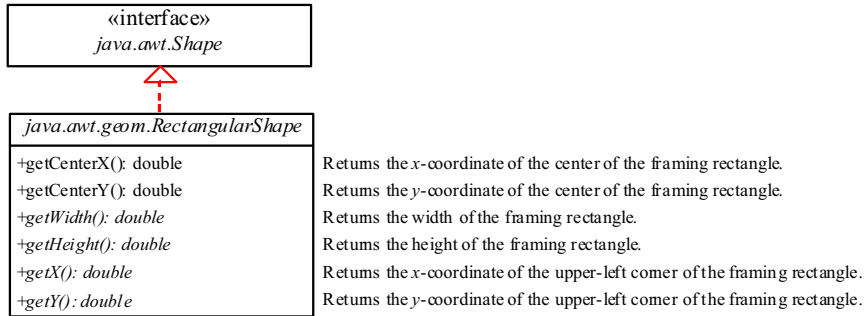


Figure 49.3

*`RectangularShape` defines a shape with a bounding rectangle.*

**<Side remark: `Rectangle2D`>**

`Rectangle2D` models a rectangle with horizontal and vertical sides. The `Rectangle` class was introduced in JDK 1.1 and now is included in Java 2D for backward compatibility. `Rectangle` is now defined as a subclass of `Rectangle2D`. It models a rectangle with integer coordinates, while `Rectangle2D.Double` and `Rectangle2D.Float` model a rectangle with double and float coordinates, respectively. You can construct a `Rectangle` using

```
new Rectangle(x, y, w, h)
```

The parameters `x` and `y` represent the upper-left corner of the rectangle, and `w` and `h` are its width and height (see Figure 49.4a).

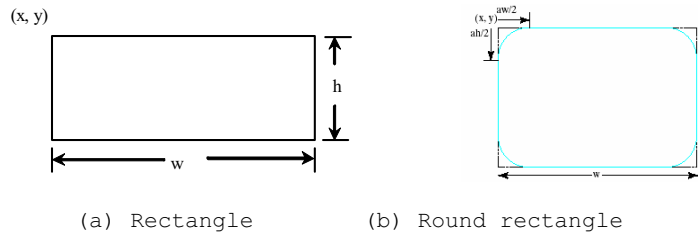


Figure 49.4

- (a) A rectangle is defined in four parameters.
- (b) A round rectangle is defined in six parameters.

The following code creates three `Rectangle2D` objects with `integer`, `double`, and `float` coordinates, respectively. The upper-left corner of the rectangle is at `(20, 40)` with width `100` and height `200`.

```
Rectangle2D ri = new Rectangle(20, 40, 100, 200);
Rectangle2D rd = new Rectangle.Double(20D, 40D, 100D, 200D);
Rectangle2D rf = new Rectangle.Double(20F, 40F, 100F, 200F);
```

**<Side remark: `RoundRectangle2D`>**

RoundRectangle2D models a rectangle with round corners. You can construct a RoundRectangle2D using

```
new RoundRectangle2D.Double(x, y, w, h, aw, ah)
```

Parameters x, y, w, and h specify a rectangle, parameter aw is the horizontal diameter of the arcs at the corner, and ah is the vertical diameter of the arcs at the corner (see Figure 49.4(b)). In other words, aw and ah are the width and the height of the oval that produces a quarter-circle at each corner.

<Side remark: Ellipse2D>

Ellipse2D models an ellipse. You can construct an Ellipse2D using

```
new Ellipse2D.Double(x, y, w, h)
```

Parameters x, y, w and h specify the bounding rectangle for the ellipse, as shown in Figure 49.5a.

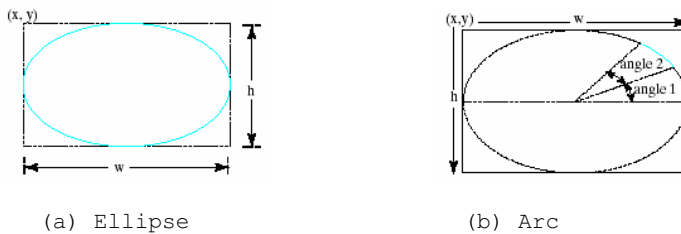


Figure 49.5

*An ellipse or oval is defined by its bounding rectangle.*

<Side remark: Arc2D>

Arc2D models an elliptic arc. You can construct an Arc2D using

```
new Arc2D.Double(x, y, w, h, startAngle, arcAngle, type)
```

Parameters x, y, w and h specify the bounding rectangle for the arc; parameter startAngle is the starting angle; arcAngle is the spanning angle (i.e., the angle covered by the arc). Angles are measured in degrees and follow the usual mathematical conventions (i.e., 0 degrees is in the easterly direction, and positive angles indicate counterclockwise rotation from the easterly direction); see Figure 49.5(b).

Parameter type is Arc2D.OPEN, Arc2D.CHORD, or Arc2D.PIE. Arc2D.OPEN specifies that the arc is open. Arc2D.CHORD specifies that the arc is connected by drawing a line segment from the start of the arc to the end of the arc. Arc2D.PIE specifies that the arc is connected by drawing straight line segments from the start of the arc segment to the center of the full ellipse and from that point to the end of the arc segment.

Listing 49.1 gives a program that demonstrates how to draw various shapes using Graphics2D. Figure 49.6 shows a sample run of the program.

#### Listing 49.1 Graphics2DDemo.java

<Side remark: Line 2: import for shape classes>



<Side remark: Line 5: applet>  
 <Side remark: Line 14: Graphics2D reference>  
 <Side remark: Line 16: draw a line>  
 <Side remark: Line 17: draw a rectangle>  
 <Side remark: Line 18: fill a rectangle>  
 <Side remark: Line 19: round rectangle>  
 <Side remark: Line 20: draw an ellipse>  
 <Side remark: Line 21: draw an arc>  
 <Side remark: Line 28: main method omitted>

```
import java.awt.*;
import java.awt.geom.*;
import javax.swing.*;

public class Graphics2DDemo extends JApplet {
 public Graphics2DDemo() {
 add(new ShapePanel());
 }

 static class ShapePanel extends JPanel {
 protected void paintComponent(Graphics g) {
 super.paintComponent(g);

 Graphics2D g2d = (Graphics2D)g;

 g2d.draw(new Line2D.Double(10, 10, 40, 80));
 g2d.draw(new Rectangle2D.Double(50, 10, 30, 70));
 g2d.fill(new Rectangle2D.Double(90, 10, 30, 70));
 g2d.fill(new RoundRectangle2D.Double(130, 10, 30, 70, 20, 30));
 g2d.draw(new Ellipse2D.Double(170, 10, 30, 70));
 g2d.draw(
 new Arc2D.Double(220, 10, 30, 70, 0, 270, Arc2D.OPEN));
 g2d.draw(new Arc2D.Double(260, 10, 30, 70, 0, 270, Arc2D.PIE));
 g2d.draw(
 new Arc2D.Double(300, 10, 30, 70, 0, 270, Arc2D.CHORD));
 }
 }
}
```



Figure 49.6

*You can draw various shapes using Java 2D.*

The shape classes Line2D, Rectangle2D, RoundRectangle2D, Arc2D, and Ellipse2D are in the java.awt.geom package. So, they are imported in line 2.

<Side remark: Line2D>

A Graphics2D reference is obtained in line 14 in order to invoke the methods in Graphics2D. The statement new Line2D.Double(10, 10, 40, 80) (line 16) creates an instance of Line2D.Double, which is also an

instance of `Line2D` and `Shape`. The instance models a line from (10, 10) to (40, 80).

**<Side remark: `Rectangle2D`>**

The statement `new Rectangle2D.Double(50, 10, 30, 70)` (line 17) creates an instance of `Rectangle2D.Double`, which is also an instance of `Rectangle2D` and `Shape`. The instance models a rectangle whose upper-left corner point is (50, 10) with width 30 and height 70.

**<Side remark: `fill`>**

The `fill(Shape)` method (line 18) renders a filled rectangle.

**<Side remark: `RoundRectangle2D`>**

The statement `new RoundRectangle2D.Double(130, 10, 30, 70, 20, 30)` (line 19) creates an instance of `RoundRectangle2D.Double`, which is also an instance of `RoundRectangle2D` and `Shape`. The instance models a round-cornered rectangle whose parameters are the same as in the `drawRoundRect(int x, int y, int w, int h, int aw, int ah)` method in the `Graphics` class.

**<Side remark: `Ellipse2D`>**

The statement `new Ellipse2D.Double(300, 10, 30, 70)` (line 20) creates an instance of `Ellipse2D.Double`, which is also an instance of `Ellipse2D` and `Shape`. The instance models an ellipse. The parameters in this constructor are the same as the parameters in the `drawOval(int x, int y, int w, int h)` method in the `Graphics` class.

**<Side remark: `Arc2D`>**

The statement `new Arc2D.Double(170, 10, 30, 70, 0, 270, Arc2D.OPEN)` (line 21) creates an instance of `Arc2D.Double`, which is also an instance of `Arc2D` and `Shape`. The instance models an open arc. The parameters in this constructor are similar to the parameters in the `drawArc(int x, int y, int w, int h, int startAngle, int arcAngle)` method in the `Graphics` class, except that the last parameter specifies whether the arc is open or closed. The value `Arc2D.OPEN` specifies that the arc is open. The value `Arc2D.PIE` (line 23) specifies that the arc is closed by drawing straight line segments from the start of the arc segment to the center of the full ellipse and from that point to the end of the arc segment. The value `Arc2D.CHORD` (line 25) specifies that the arc is closed by drawing a straight line segment from the start of the arc segment to the end of the arc segment.

## 49.5 Coordinate Transformations

Java 2D provides the classes for modeling geometric objects. It also supports coordinate transformations using translation, rotation, and scaling.

### 49.5.1 Translations

You can use the `translate(double x, double y)` method in the `Graphics` class to move the subsequent rendering by the specified distance relative to the previous position. For example, `translate(5, -10)` moves subsequent rendering 5 pixels to the right and 10 pixels up from the previous position, and `translate(-5, 10)` moves all shapes 5 pixels to the left and 10 pixels down from the previous position. Figure 49.7 shows a rectangle displayed before and after applying translation. After invoking `g2d.translate(-6, 4)`, the rectangle is displayed 6 pixels to the left and 4 pixels down from the previous position.

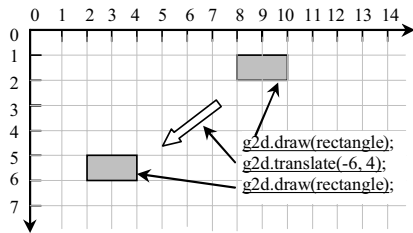


Figure 49.7

(a) After applying `g2d.translate(-6, 4)`, the subsequent rendering of the rectangle is moved by the specified distance relative to the previous position.

Listing 49.2 gives a program that demonstrates the effect of translation of coordinates. Figure 49.8 shows a sample run of the program.

#### Listing 49.2 TranslationDemo.java

```

<Side remark: Line 2: import for shape classes>
<Side remark: Line 5: applet>
<Side remark: Line 14: Graphics2D reference>
<Side remark: Line 15: a rectangle>
<Side remark: Line 17: random number>
<Side remark: Line 19: set a new color>
<Side remark: Line 21: display rectangle>
<Side remark: Line 22: translate>
<Side remark: Line 26: main method omitted>

import java.awt.*;
import java.awt.geom.*;
import javax.swing.*;

public class TranslateDemo extends JApplet {
 public TranslateDemo() {
 add(new ShapePanel());
 }
}

class ShapePanel extends JPanel {
 protected void paintComponent(Graphics g) {
 super.paintComponent(g);

 Graphics2D g2d = (Graphics2D)g;
 Rectangle2D rectangle = new Rectangle2D.Double(10, 10, 50, 60);

 java.util.Random random = new java.util.Random();
 for (int i = 0; i < 10; i++) {
 g2d.setColor(new Color(random.nextInt(256),
 random.nextInt(256), random.nextInt(256)));
 g2d.draw(rectangle);
 g2d.translate(20, 5);
 }
 }
}

```



Figure 49.8

*The rectangles are displayed successively in new locations.*

Line 17 creates a `Random` object. The `Random` class was introduced in §8.6.2, “The `Random` Class.” Invoking `random.nextInt(256)` (line 19) returns a random `int` value between 0 and 255. The `setColor` method (line 19) sets a new color for subsequent rendering. Line 21 draws a rectangle. The `translate(20, 5)` method in line 22 moves the subsequent rendering 20 pixels to the right and 5 pixels down.

#### 49.5.2 Rotations

You can use the `rotate(double theta)` method in the `Graphics2D` class to rotate subsequent rendering by `theta` degrees from the origin clockwise, where `theta` is a double value in radians. By default the origin is (0, 0). You can use the `translate(x, y)` method to move the origin to a specified location. For example, `rotate(Math.PI / 4)` rotates subsequent rendering 45 degrees counterclockwise along the northern direction from the origin, as shown in Figure 49.9.

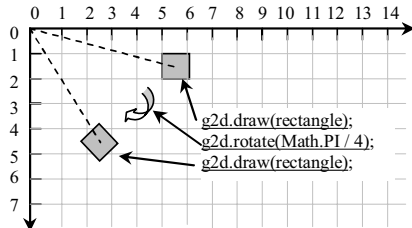


Figure 49.9

*After performing `g2d.rotate(Math.PI / 4)`, the rectangle is rotated in 45 degrees from the origin.*

Listing 49.3 gives a program that demonstrates the effect of rotation of coordinates. Figure 49.10 shows a sample run of the program.

#### Listing 49.3 RotationDemo.java

```
<Side remark: Line 2: import for shape classes>
<Side remark: Line 5: applet>
<Side remark: Line 14: Graphics2D reference>
<Side remark: Line 15: a rectangle>
<Side remark: Line 17: new origin>
<Side remark: Line 18: draw center point>
<Side remark: Line 19: random number>
```

<Side remark: Line 21: set a new color>  
<Side remark: Line 23: display rectangle>  
<Side remark: Line 24: rotate>  
<Side remark: Line 28: main method omitted>

```
import java.awt.*;
import java.awt.geom.*;
import javax.swing.*;

public class RotationDemo extends JApplet {
 public RotationDemo() {
 add(new ShapePanel());
 }

 class ShapePanel extends JPanel {
 protected void paintComponent(Graphics g) {
 super.paintComponent(g);

 Graphics2D g2d = (Graphics2D)g;
 Rectangle2D rectangle = new Rectangle2D.Double(20, 20, 50, 60);

 g2d.translate(150, 120); // Move origin to the center
 g2d.fill(new Ellipse2D.Double(-5, -5, 10, 10));
 java.util.Random random = new java.util.Random();
 for (int i = 0; i < 10; i++) {
 g2d.setColor(new Color(random.nextInt(256),
 random.nextInt(256), random.nextInt(256)));
 g2d.draw(rectangle);
 g2d.rotate(Math.PI / 5);
 }
 }
 }
}
```

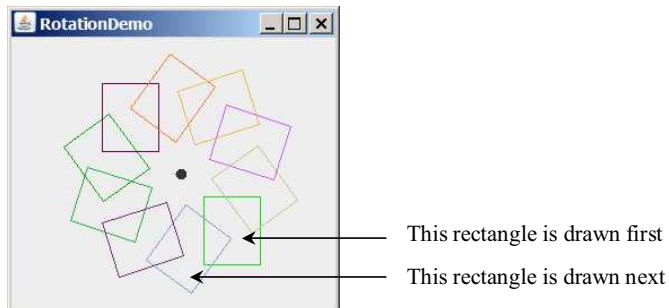


Figure 49.10

After the `rotate` method is invoked, the rectangles are displayed successively in new locations.

The `translate(150, 120)` method moves the origin from (0, 0) to (150, 120) (line 17). The loop is repeated ten times. Each iteration sets a new color randomly (line 21), draws the rectangle (line 23), and rotates 36 degrees from the new origin (line 24).

### 49.5.3 Scaling

You can use the `scale(double sx, double sy)` method in the `Graphics2D` class to resize subsequent rendering by the specified scaling factors. For example, `scale(2, 2)` resizes the object by doubling the x- and y-coordinates in the object, as shown in Figure 49.11.

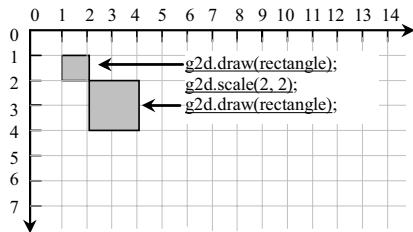


Figure 49.11

After performing `g2d.scale(2, 2)`, the x- and y-coordinates in the original rectangle are doubled.

Listing 49.4 gives a program that demonstrates the effect of using scaling. Figure 49.12 shows a sample run of the program.

**Listing 49.4 ScalingDemo.java**

```

<Side remark: Line 2: import for shape classes>
<Side remark: Line 5: applet>
<Side remark: Line 14: Graphics2D reference>
<Side remark: Line 15: a rectangle>
<Side remark: Line 18: display rectangle>
<Side remark: Line 19: scale>
<Side remark: Line 23: main method omitted>
import java.awt.*;
import java.awt.geom.*;
import javax.swing.*;

public class ScalingDemo extends JApplet {
 public ScalingDemo() {
 add(new ShapePanel());
 }

 class ShapePanel extends JPanel {
 protected void paintComponent(Graphics g) {
 super.paintComponent(g);

 Graphics2D g2d = (Graphics2D)g;
 Rectangle2D rectangle = new Rectangle2D.Double(10, 10, 10, 10);

 for (int i = 0; i < 4; i++) {
 g2d.draw(rectangle);
 g2d.scale(2, 2);
 }
 }
 }
}

```

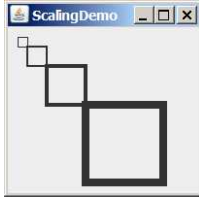


Figure 49.12

*After scaling is applied, the rectangles are displayed successively.*

The program draws four rectangles. The upper-left corner of the first rectangle is at (10, 10). After invoking `scale(2, 2)` (line 19) on the `Graphics2D` object `g2d` in the first iteration of the loop, the upper-left corner of the second rectangle is at (20, 20), since this `scale` method causes the coordinates in the current object to be doubled. After invoking `scale(2, 2)` (line 19) on the `Graphics2D` object `g2d` in the second iteration of the loop, the upper-left corner of the third rectangle is at (40, 40). After invoking `scale(2, 2)` (line 19) on the `Graphics2D` object `g2d` in the third iteration of the loop, the upper-left corner of the fourth rectangle is at (80, 80).

It is interesting to note that the thickness of line segments also doubles each time `scale(2, 2)` is invoked. We will discuss the thickness of lines in the next section.

## 49.6 Strokes

Java 2D allows you to specify the attributes of lines, called *strokes*. You can specify the width of the line, how the line ends (called *end caps*), how lines join together (called *line joins*), and whether the line is dashed. These attributes are defined in a `Stroke` object. You can create a `Stroke` object using the `BasicStroke` class, as shown in Figure 49.13.

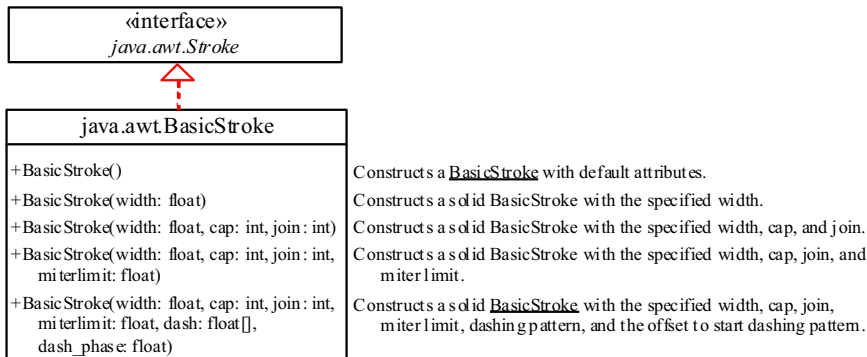


Figure 49.13

*You can create a `Stroke` using the `BasicStroke` class.*

The parameter `width` specifies the thickness of the stroke with a default value `1.0`.

The parameter `cap` is one of three values:

- `BasicStroke.CAP_ROUND` for round cap.
- `BasicStroke.CAP_SQUARE` for square cap.
- `BasicStroke.CAP_BUTT` for no added decorations.

The parameter `join` is one of three values:

- `BasicStroke.JOIN_BEVEL` for joining the outer corners of their wide outlines with a straight segment.
- `BasicStroke.JOIN_MITER` for joining path segments by extending their outside edges until they meet.
- `BasicStroke.JOIN_ROUND` for joining path segments by rounding off the corner at a radius of half the line width.

The parameter `miterlimit` sets a limit for `JOIN_MITER` to prevent a very long join when the angle between the two lines is small.

The parameter `dash` array defines a dash pattern by alternating between opaque and transparent sections. The `dash_phase` parameter specifies the offset to start the dashing pattern.

To set a stroke in `Graphics2D`, use

```
void setStroke(Stroke stroke)
```

Listing 49.5 gives a program that demonstrates the effect of using basic strokes. Figure 49.14 shows a sample run of the program.

#### Listing 49.5 BasicStrokeDemo.java

<Side remark: Line 2: import for shape classes>

<Side remark: Line 5: applet>

<Side remark: Line 14: [Graphics2D](#) reference>

<Side remark: Line 16: set a stroke>

<Side remark: Line 18: draw a line>

<Side remark: Line 20: translate>

<Side remark: Line 31: draw a rectangle>

<Side remark: Line 49: [main](#) method omitted>

```
import java.awt.*;
import java.awt.geom.*;
import javax.swing.*;

public class BasicStrokeDemo extends JApplet {
 public BasicStrokeDemo() {
 add(new ShapePanel());
 }

 class ShapePanel extends JPanel {
 protected void paintComponent(Graphics g) {
 super.paintComponent(g);

 Graphics2D g2d = (Graphics2D)g;
 g2d.setStroke(new BasicStroke(15.0f, BasicStroke.CAP_ROUND,
```



```

 BasicStroke.JOIN_BEVEL));
 g2d.draw(new Line2D.Double(10, 10, 40, 80));

 g2d.translate(100, 0);
 g2d.setStroke(new BasicStroke(15.0f, BasicStroke.CAP_SQUARE,
 BasicStroke.JOIN_BEVEL));
 g2d.draw(new Line2D.Double(10, 10, 40, 80));

 g2d.translate(100, 0);
 g2d.setStroke(new BasicStroke(15.0f, BasicStroke.CAP_BUTT,
 BasicStroke.JOIN_BEVEL));
 g2d.draw(new Line2D.Double(10, 10, 40, 80));

 g2d.translate(100, 0);
 g2d.draw(new Rectangle2D.Double(10, 10, 30, 70));

 g2d.translate(100, 0);
 g2d.setStroke(new BasicStroke(15.0f, BasicStroke.CAP_ROUND,
 BasicStroke.JOIN_MITER));
 g2d.draw(new Rectangle2D.Double(10, 10, 30, 70));

 g2d.translate(100, 0);
 g2d.setStroke(new BasicStroke(15.0f, BasicStroke.CAP_SQUARE,
 BasicStroke.JOIN_ROUND));
 g2d.draw(new Rectangle2D.Double(10, 10, 30, 70));

 g2d.translate(100, 0);
 g2d.setStroke(new BasicStroke(4.0f, BasicStroke.CAP_SQUARE,
 BasicStroke.JOIN_ROUND, 1.0f, new float[]{8}, 0));
 g2d.draw(new Line2D.Double(10, 10, 40, 80));
}
}
}

```



Figure 49.14

*You can specify the attributes for strokes.*

The statement `new BasicStroke(15.0f, BasicStroke.CAP_ROUND, BasicStroke.JOIN_BEVEL)` (line 16) creates an instance of `BasicStroke`, which is also an instance of the `Stroke` interface. The `setStroke(Stroke)` method sets a `Stroke` object for the `Graphics2D` context. The program sets new `Stroke` objects in lines 21, 26, 34, 39, 49. Line 44 sets a new `Stroke` object with width `4.0f`, round square cap, round join, miter limit `1.0`, dashing pattern `{8}`, and dash phase `0`.

#### 49.7 Paint

You can use the `setColor(Color c)` method in the `Graphics` class to set a color. It sets only a solid color. `Graphics2D` provides the `setPaint(Paint p)` method to set a paint. `Paint` is a generalization of color. It can represent more attributes than simple solid colors.

`Paint` is an interface for three concrete classes including `Color`, as shown in Figure 49.15.

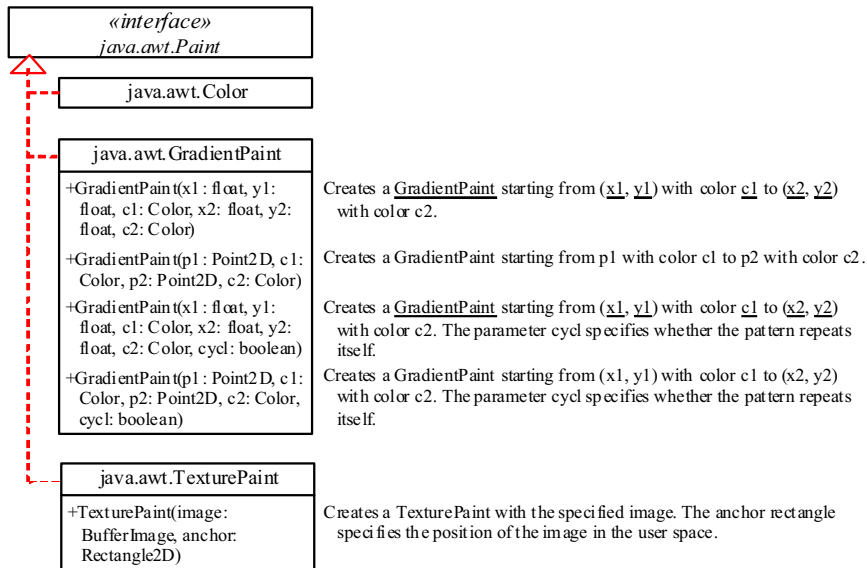


Figure 49.15

A `Paint` object specifies colors.

`GradientPaint` defines a varying color, specified by two points and two colors. As the location moves from the first point to the second, the paint changes gradually from the first color to the second. A `GradientPaint` can be cyclic or acyclic. A cyclic paint repeats the same pattern periodically.

`TexturePaint` defines an image to fill a shape or characters. The parameter `image` is specified as a `BufferedImage`. The `anchor` parameter specifies a rectangle on which the image is anchored. The image is repeated around the anchor rectangle, as shown in Figure 49.16.

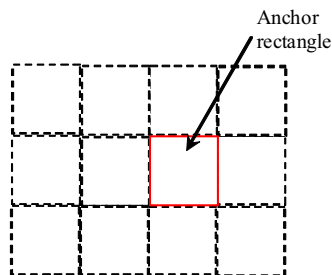


Figure 49.16

A TexturePaint is specified by an image in an anchor rectangle.

Listing 49.6 gives a program that demonstrates the effect of using GradientPaint and TexturePaint. Figure 49.17 shows a sample run of the program.

**Listing 49.6 PaintDemo.java**

<Side remark: Line 17: GradientPaint>  
<Side remark: Line 29: solid color>  
<Side remark: Line 35: get URL>  
<Side remark: Line 36: TexturePaint>  
<Side remark: Line 39: set paint>  
<Side remark: Line 60: main method>

```
import java.awt.*;
import java.awt.geom.*;
import javax.imageio.ImageIO;
import javax.swing.*;

public class PaintDemo extends JApplet {
 public PaintDemo() {
 add(new ShapePanel());
 }

 class ShapePanel extends JPanel {
 protected void paintComponent(Graphics g) {
 super.paintComponent(g);

 Graphics2D g2d = (Graphics2D)g;

 g2d.setPaint(new GradientPaint(10, 10, Color.RED, 40, 40,
 Color.BLUE, true));
 g2d.fill(new Rectangle2D.Double(10, 10, 90, 70));
 g2d.setFont(new Font("Serif", Font.BOLD, 50));
 g2d.drawString("GradientPaint", 10, 120);

 g2d.translate(100, 0);
 g2d.setPaint(new GradientPaint(10, 10, Color.YELLOW, 40, 40,
 Color.BLACK));
 g2d.fill(new Rectangle2D.Double(10, 10, 90, 70));

 g2d.translate(100, 0);
 g2d.setPaint(Color.YELLOW);
 g2d.fill(new Rectangle2D.Double(10, 10, 90, 70));

 try {
 java.net.URL url =
 getClass().getClassLoader().getResource("image/ca.gif");
 java.awt.image.BufferedImage image = ImageIO.read(url);
 TexturePaint texturePaint = new TexturePaint(image,
 new Rectangle2D.Double(10, 10, 100, 70));
 g2d.translate(130, 0);
 g2d.setPaint(texturePaint);
 g2d.fill(new Ellipse2D.Double(10, 10, 100, 70));
 }
 }
 }
}
```



The statement in lines 36-37

```
TexturePaint texturePaint = new TexturePaint(image,
 new Rectangle2D.Double(10, 10, 100, 70));
```

creates a `TexturePaint` with the image anchored in the rectangle whose upper-left corner is (10, 10) and width and height are 100 and 70. This `TexturePaint` object is set in `g2d` in line 39. Line 40 fills an ellipse with this `TexturePaint`, as shown in Figure 49.18a.

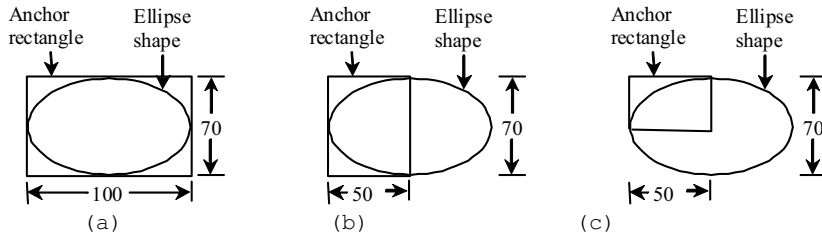


Figure 49.18

*The anchor rectangle defines the size and position of the starting image.*

The statement in lines 42-43

```
texturePaint = new TexturePaint(image,
 new Rectangle2D.Double(10, 10, 50, 70));
```

creates a `TexturePaint` with the image anchored in the rectangle whose upper-left corner is (10, 10) and width and height are 50 and 70. This `TexturePaint` object is set in `g2d` in line 45. Line 46 fills an ellipse with this `TexturePaint`, as shown in Figure 49.18(b). As you see in the sample output in Figure 49.17, the texture paint is repeated from the anchor rectangle.

Line 53 displays a string. The characters are filled with the paint set in line 51.

#### 49.8 `QuadCurve2D` and `CubicCurve2D`

Java 2D provides the `QuadCurve2D` and `CubicCurve2D` classes for modeling quadratic curves and cubic curves. `QuadCurve2D.Double` and `QuadCurve2D.Float` are two concrete subclasses of `QuadCurve2D`. `CubicCurve2D.Double` and `CubicCurve2D.Float` are two concrete subclasses of `CubicCurve2D`.

A quadratic curve is mathematically defined as a quadratic polynomial. To create a `QuadCurve2D.Double`, use the following constructor:

```
QuadCurve2D.Double(double x1, double y1,
 double ctrlx, double ctrly, double x2, double y2)
```

where  $(x_1, y_1)$  and  $(x_2, y_2)$  specify two endpoints and  $(ctrlx, ctrly)$  is a control point. The control point is usually not on the curve instead of defining the trend of the curve, as shown in Figure 49.19a.

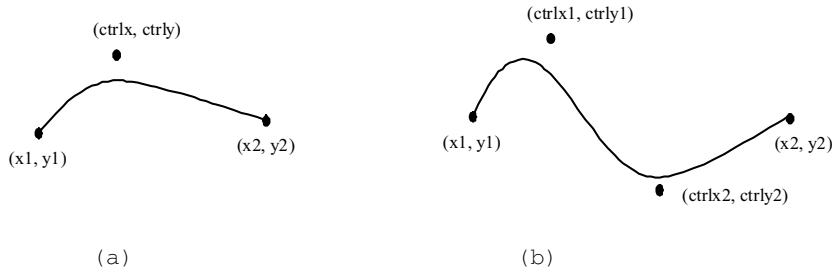


Figure 49.19

(a) A quadratic curve is specified using three points. (b) A cubic curve is specified using four points.

A cubic curve is mathematically defined as a cubic polynomial. To create a `CubicCurve2D.Double`, use the following constructor:

```
CubicCurve2D.Double(double x1, double y1, double ctrlx1,
 double ctrly1, double ctrlx2, double ctrly2, double x2, double y2)
```

where  $(x_1, y_1)$  and  $(x_2, y_2)$  specify two endpoints and  $(ctrlx_1, ctrly_1)$  and  $(ctrlx_2, ctrly_2)$  are two control points. The control points are usually not on the curve instead of defining the trend of the curve, as shown in Figure 49.19(b).

Listing 49.7 gives a program that demonstrates how to draw quadratic curves and cubic curves. Figure 49.20 shows a sample run of the program.

#### Listing 49.7 CurveDemo.java

```
<Side remark: Line 2: import for shape classes>
<Side remark: Line 5: applet>
<Side remark: Line 14: Graphics2D reference>
<Side remark: Line 17: quadratic curve>
<Side remark: Line 22: cubic curve>
<Side remark: Line 32: main method omitted>
import java.awt.*;
import java.awt.geom.*;
import javax.swing.*;

public class CurveDemo extends JApplet {
 public CurveDemo() {
 add(new CurvePanel());
 }

 static class CurvePanel extends JPanel {
 protected void paintComponent(Graphics g) {
 super.paintComponent(g);

 Graphics2D g2d = (Graphics2D)g;
```

```

// Draw a quadratic curve
g2d.draw(new QuadCurve2D.Double(10, 80, 40, 20, 150, 56));
g2d.fillOval(40 + 3, 20 + 3, 6, 6);
g2d.drawString("Control point", 40 + 5, 20);

// Draw a cubic curve
g2d.draw(new CubicCurve2D.Double
(200, 80, 240, 20, 350, 156, 450, 80));
g2d.fillOval(240 + 3, 20 + 3, 6, 6);
g2d.drawString("Control point 1", 240 + 3, 20);
g2d.fillOval(350 + 3, 156 + 3, 6, 6);
g2d.drawString("Control point 2", 350 + 3, 156 + 3);
}
}
}

```

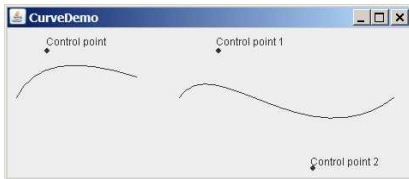


Figure 49.20

You can draw quadratic and cubic curves using Java 2D.

**<Side remark: [QuadCurve2D](#)>**

A [Graphics2D](#) reference is obtained in line 14 in order to invoke the methods in [Graphics2D](#). The statement `new QuadCurve2D.Double(10, 80, 40, 20, 150, 56)` (line 17) creates an instance of [QuadCurve2D.Double](#), which is also an instance of [QuadCurve2D](#) and [Shape](#). The instance models a quadratic curves with two endpoints (10, 80), (150, 56) and a control point (40, 20).

The `fillOval` (line 18) and `drawString` (line 19) methods are defined in the [Graphics](#) class and so can be used in the [Graphics2D](#) class.

**<Side remark: [CubicCurve2D](#)>**

The statement `new CubicCurve2D.Double(200, 80, 240, 20, 350, 156, 450, 80)` (lines 22-23) creates an instance of [CubicCurve2D.Double](#), which is also an instance of [QuadCurve2D](#) and [Shape](#). The instance models a quadratic curves with two endpoints (200, 80), (450, 80) and two control points (240, 20), (350, 156).

## 49.9 Path2D

The [Path2D](#) class models an arbitrary geometric path. [Path2D.Double](#) and [Path2D.Float](#) are two concrete subclasses of [Path2D](#). Java 2D also contains the [GeneralPath](#) class which is now superseded by [Path2D.Float](#).

You can construct path segments using the methods, as shown in Figure 49.21.

**<PD: UML Class Diagram>**

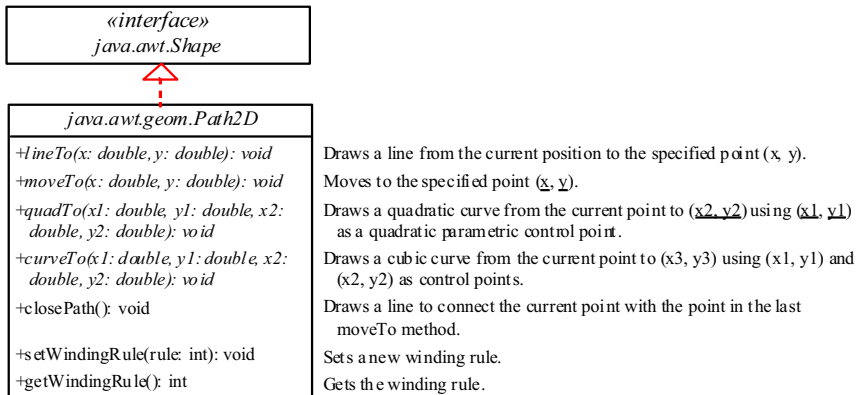


Figure 49.21

The `Path2D` class contains the methods for constructing path segments.

You may create a `Path2D` using a constructor from `Path2D.Double` and `Path2D.Float`. The process of the path construction can be viewed as drawing with a pen. At any moment, the pen has a current position. You can use the `moveTo(x, y)` method to move the pen to the new position at point (x, y), use the `lineTo(x, y)` to add a point (x, y) to the path by drawing a straight line from the current point to this new point, use the `quadTo(ctrlx, ctrly, x, y)` method to draw a quadratic curve from the current location to (x, y) using (ctrlx, ctrly) as the control point, use the `curveTo(ctrlx1, ctrly1, ctrlx2, ctrly2, x, y)` method to draw a cubic curve from the current location to (x, y) using (ctrlx1, ctrly1) and (ctrlx2, ctrly2) as the control points, and use the `closePath()` method to connect the current point with the point in the last `moveTo` method.

Listing 49.8 gives a program that demonstrates how to draw a shape using `Path2D`. Figure 49.22 shows a sample run of the program.

#### Listing 49.8 Path2DDemo.java

```

<Side remark: Line 2: import for shape classes>
<Side remark: Line 5: applet>
<Side remark: Line 14: Graphics2D reference>
<Side remark: Line 16: new position>
<Side remark: Line 17: draw a cubic curve>
<Side remark: Line 18: new position>
<Side remark: Line 19: draw a cubic curve>
<Side remark: Line 20: draw a line>
<Side remark: Line 21: close path>
<Side remark: Line 23: display path>
<Side remark: Line 26: main method omitted>
import java.awt.*;
import java.awt.geom.*;
import javax.swing.*;

public class Path2DDemo extends JApplet {
 public Path2DDemo() {
 add(new ShapePanel());
 }
}

```



```

class ShapePanel extends JPanel {
 protected void paintComponent(Graphics g) {
 super.paintComponent(g);

 Graphics2D g2d = (Graphics2D)g;
 Path2D path = new Path2D.Double();
 path.moveTo(100, 100);
 path.curveTo(150, 50, 250, 150, 300, 100);
 path.moveTo(100, 100);
 path.curveTo(150, 150, 250, 50, 300, 100);
 path.lineTo(200, 20);
 path.closePath();

 g2d.draw(path);
 }
}

```



Figure 49.22

You can draw an arbitrary shape using the `Path2D` class.

The statement `new Path2D.Double()` (line 15) creates an empty path. The `moveTo(100, 100)` method (line 16) sets the current pen position at (100, 100). Invoking `path.curveTo(150, 50, 250, 150, 300, 100)` (line 17) creates a cubic curve from (100, 100) to (300, 100) with control points (150, 50) and (250, 150). Invoking `path.moveTo(100, 100)` (line 18) moves the pen position back to (100, 100). Invoking `path.curveTo(150, 150, 250, 50, 300, 100)` (line 19) creates a cubic curve from (100, 100) to (300, 100) with control points (150, 150) and (250, 50). Now the current position is at (300, 100). Invoking `path.lineTo(200, 20)` (line 20) creates a line from (300, 100) to (200, 20). Invoking `path.closePath()` (line 21) draws a line connecting the current position (i.e., (200, 20)) with the last `moveTo` position (i.e., (100, 100)). Finally, Invoking `g2d.draw(path)` (line 23) draws the path.

For a simple shape, it is easy to decide which point is inside a shape. A path may form many shapes. It is not easy to decide which point is inside an enclosed path. Java 2D uses the winding rules to define the interior points. There are two winding rules: `WIND_EVEN_ODD` and `WIND_NON_ZERO`.

**<Side remark: `WIND_EVEN_ODD`>**

The `WIND_EVEN_ODD` rule defines a point as inside a path if a ray from the point toward infinity in an arbitrary direction intersects the path an odd number of times. Consider the path in Figure 49.23a. Points A and C are outside the path, because the ray intersects the path twice. Point B is inside the path, because the ray intersects the path once.

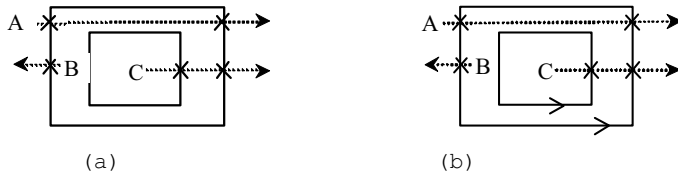


Figure 49.23

The `WIND EVEN ODD` and `WIND NON ZERO` rules define interior points.

<Side remark: `WIND NON ZERO`>

With the `WIND NON ZERO` rule, the direction of the path is taken into consideration. A point is inside a path if a ray from the point toward infinity in an arbitrary direction intersects the path an unequal number of opposite directions. Consider the path in Figure 49.23(b). Point A is outside the path, because the ray intersects the path twice in opposite directions. Point B is inside the path, because the ray intersects the path once. Point C is inside the path, because the ray intersects the path twice in the same directions. By default, a `Path2D` is created using the `WIND NON ZERO` rule. You can use the `setWindingRule` method to set a new winding rule.

Listing 49.9 gives a program that demonstrates winding rules in `Path2D`. Figure 49.24 shows a sample run of the program.

#### Listing 49.9 `WindingRuleDemo.java`

```

<Side remark: Line 2: import for shape classes>
<Side remark: Line 5: applet>
<Side remark: Line 14: Graphics2D reference>
<Side remark: Line 16: new origin>
<Side remark: Line 17: draw path>
<Side remark: Line 19: new origin>
<Side remark: Line 20: create a path>
<Side remark: Line 21: new winding rule>
<Side remark: Line 22: fill path>
<Side remark: Line 24: new origin>
<Side remark: Line 25: create a path>
<Side remark: Line 26: new winding rule>
<Side remark: Line 27: fill path>
<Side remark: Line 30: create a path>
<Side remark: Line 49: main method omitted>
import java.awt.*;
import java.awt.geom.*;
import javax.swing.*;

public class WindingRuleDemo extends JApplet {
 public WindingRuleDemo() {
 add(new ShapePanel());
 }

 class ShapePanel extends JPanel {
 protected void paintComponent(Graphics g) {
 super.paintComponent(g);

```

```

Graphics2D g2d = (Graphics2D)g; // Get Graphics2D

g2d.translate(10, 10); // Translate to a new origin
g2d.draw(createAPath()); // Create and draw a path

g2d.translate(160, 0); // Translate to a new origin
Path2D path2 = createAPath(); // Create a path
path2.setWindingRule(Path2D.WIND_EVEN_ODD); // Set a new rule
g2d.fill(path2); // Create and fill a path

g2d.translate(160, 0); // Translate to a new origin
Path2D path3 = createAPath(); // Create a path
path3.setWindingRule(Path2D.WIND_NON_ZERO); // Set a new rule
g2d.fill(path3); // Create and fill a path
}

private Path2D createAPath() {
 // Define the outer rectangle
 Path2D path = new Path2D.Double();
 path.moveTo(0, 0);
 path.lineTo(0, 100);
 path.lineTo(100, 100);
 path.lineTo(100, 0);
 path.lineTo(0, 0);

 // Define the inner rectangle
 path.moveTo(30, 30);
 path.lineTo(30, 70);
 path.lineTo(70, 70);
 path.lineTo(70, 30);
 path.lineTo(30, 30);

 return path;
}
}
}
}

```

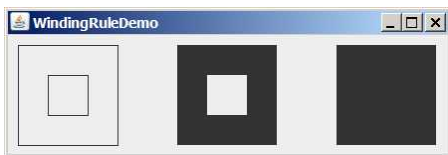


Figure 49.24

*The winding rule defines the interior points.*

**<Side remark: `createAPath`>**

The `createAPath()` method creates a path for two rectangles. The outer rectangle is created in lines 33–37 and the inner rectangle in lines 40–49.

The program translates the coordinate's origin to (10, 10) in line 16, invokes `createAPath` to create a path, and displays it in line 17.

The program translates the coordinate's origin to (160, 0) in line 19, creates a new path (line 20), sets the path winding rule to `WIND_EVEN_ODD` (line 21), and displays it in line 22.

The program translates the coordinate's origin to (160, 0) in line 24, creates a new path (line 25), sets the path winding rule to `WIND_NON_ZERO` (line 26), and displays it in line 27.

Note that if a path is unclosed, the `fill` method implicitly closes it and draws a filled path.

#### 49.10 Constructive Area Geometry

Shapes can be combined to create new shapes. This is known as *constructive area geometry*. Java 2D provides class `Area` to perform constructive area geometry, as shown in Figure 49.25.

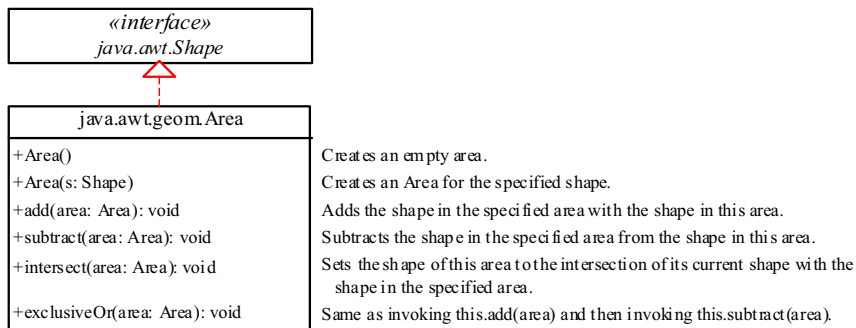


Figure 49.25

The `Area` class contains the methods for constructing new areas.

`Area` implements `Shape` and provides the methods `add`, `subtract`, `intersect`, and `exclusiveOr` to perform set-theoretic operations union, difference, intersection, and symmetric difference. These operations perform on the shapes stored in the areas. The union of two areas consists of all points that are in either area. The difference of two areas consists of the points that are in the first area, but not in the second area. The intersection of two areas consists of all points that are in both areas. The symmetric difference consists of the points that are in exactly one of the two areas.

Listing 49.10 gives a program that demonstrates constructive geometry using the `Area` class. Figure 49.26 shows a sample run of the program.

#### Listing 49.10 AreaDemo.java

```

<Side remark: Line 2: import for shape classes>
<Side remark: Line 5: applet>
<Side remark: Line 14: Graphics2D reference>
<Side remark: Line 17: two shapes>
<Side remark: Line 19: new origin>
<Side remark: Line 23: draw shapes>
<Side remark: Line 25: add>
<Side remark: Line 30: fill area>

```

<Side remark: Line 33: subtract>  
 <Side remark: Line 35: fill area>  
 <Side remark: Line 38: intersect>  
 <Side remark: Line 40: fill area>  
 <Side remark: Line 42: exclusiveOr>  
 <Side remark: Line 43: fill area>  
 <Side remark: Line 48: main method omitted>

```

import java.awt.*;
import java.awt.geom.*;
import javax.swing.*;

public class AreaDemo extends JApplet {
 public AreaDemo() {
 add(new ShapePanel());
 }

 class ShapePanel extends JPanel {
 protected void paintComponent(Graphics g) {
 super.paintComponent(g);

 Graphics2D g2d = (Graphics2D)g; // Get Graphics2D

 // Create two shapes
 Shape shape1 = new Ellipse2D.Double(0, 0, 50, 50);
 Shape shape2 = new Ellipse2D.Double(25, 0, 50, 50);
 g2d.translate(10, 10); // Translate to a new origin
 g2d.draw(shape1); // Draw the shape
 g2d.draw(shape2); // Draw the shape

 Area area1 = new Area(shape1); // Create an area
 Area area2 = new Area(shape2);
 area1.add(area2); // Add area2 to area1
 g2d.translate(100, 0); // Translate to a new origin
 g2d.draw(area1); // Draw the outline of the shape in the area

 g2d.translate(100, 0); // Translate to a new origin
 g2d.fill(area1); // Fill the shape in the area

 area1 = new Area(shape1);
 area1.subtract(area2); // Subtract area2 from area1
 g2d.translate(100, 0); // Translate to a new origin
 g2d.fill(area1); // Fill the shape in the area

 area1 = new Area(shape1);
 area1.intersect(area2); // Intersection of area2 with area1
 g2d.translate(100, 0); // Translate to a new origin
 g2d.fill(area1); // Fill the shape in the area

 area1 = new Area(shape1);
 area1.exclusiveOr(area2); // Exclusive or of area2 with area1
 g2d.translate(100, 0); // Translate to a new origin
 g2d.fill(area1); // Fill the shape in the area
 }
 }
}

```



Figure 49.26

The `Area` class can be used to perform constructive geometry.

The program creates two ellipses (lines 17-18) and displays them (lines 20-21). The program creates two areas and invokes `add` (line 25), `subtract` (line 33), `intersect` (line 38), and `exclusiveOr` (line 43) to perform constructive area geometry.

### Key Terms

- constructive area geometry
- cubic curves
- gradient paint
- quadratic curves
- rotation
- scaling
- stroke
- texture paint
- translation
- `WIND_EVEN_ODD`
- `WIND_NON_ZERO`

### Chapter Summary

1. The Java 2D API provides the `java.awt.Graphics2D` class, which extends `java.awt.Graphics` with advanced capabilities for rendering graphics.
2. The Java 2D API provides an object-oriented approach that separates rendering from modeling. All shapes are defined under the `Shape` interface.
3. Classes `Line2D`, `Rectangle2D`, `RoundRectangle2D`, `Arc2D`, `Ellipses2D`, `QuadCurve2D`, `CubicCurve2D`, and `Path2D` are abstract classes. Each contains two concrete static inner classes named `Double` and `Float` for `double` and `float` coordinates, respectively. The inner classes are subclasses of their respective abstract classes.
4. A point can be modeled using the abstract `Point2D` class. It contains two concrete static inner classes `Point2D.Double` and `Point2D.Float`, which are subclasses of `Point2D`.
5. The `Graphics2D` class is for rendering shapes. You can invoke its `draw(Shape)` method to render the boundary of the shape and `fill(Shape)` method to fill the interior of the shape.
6. You can use the `translate(double x, double y)` method in the `Graphics` class to move the subsequent rendering by the specified distance relative to the previous position.
7. You can use the `rotate(double theta)` method in the `Graphics2D` class to rotate subsequent rendering by `theta` degrees from the origin, where `theta` is a double value in radians.
8. You can use the `scale(double sx, double sy)` method in the `Graphics2D` class to resize subsequent rendering by the specified scaling factors.
9. Java 2D allows you to specify the attributes of lines, called *strokes*.

10. You can specify the width of the line, how the line ends (called *end caps*), how lines join together (called *line joins*), and whether the line is dashed. These attributes are defined in a Stroke object.
11. You can create a Stroke object using the BasicStroke class.
12. To set a stroke, use the setStroke(Stroke) method in the Graphics2D class.
13. Graphics2D provides the setPaint(Paint) method to set a paint. Paint is a generalization of color. It has more attributes than simple solid colors.
14. GradientPaint defines a varying color, specified by two points and two colors. As the location moves from the first point to the second, the paint changes gradually from the first color to the second.
15. A GradientPaint can be cyclic or acyclic. A cyclic paint repeats the same pattern periodically.
16. TexturePaint defines an image to fill a shape or characters. A texture paint is defined by an image anchored in a rectangle.
17. Java 2D provides the QuadCurve2D and CubicCurve2D classes for modeling quadratic curves and cubic curves.
18. A quadratic curve is mathematically defined as a quadratic polynomial.
19. A cubic curve is mathematically defined as a cubic polynomial.
20. The Path2D class models an arbitrary geometric path. Path2D.Double and Path2D.Float are two concrete subclasses of Path2D.
21. The winding rule defines interior points in a path.
22. The WIND\_EVEN\_ODD rule defines a point as inside a path if a ray from the point toward infinity in an arbitrary direction intersects the path an odd number of times.
23. With the WIND\_NON\_ZERO rule, the direction of the path is taken into consideration. A point is inside a path if a ray from the point toward infinity in an arbitrary direction intersects the path an unequal number of opposite directions.
24. Java 2D provides class Area to perform constructive area geometry.
25. Area implements Shape and provides the methods add, subtract, intersect, and exclusiveOr to perform set-theoretic operations union, difference, intersection, and symmetric difference.

### Test Questions

Do the test questions for this chapter online at  
[www.cs.armstrong.edu/liang/intro9e/test.html](http://www.cs.armstrong.edu/liang/intro9e/test.html).

### Review Questions

*Sections 49.2-49.3*

- 49.1 How do you obtain a reference to a Graphics2D object?
- 49.2 List some methods defined in the Shape interface.
- 49.3 How do you create a Line2D object?
- 49.4 Are Line2D.Double and Line2D.Float inner classes of Line2D? Are they also subclasses of Line2D?

49.5 How do you render a Shape object?

49.6 What are the relationships among Point2D, Point2D.Double, Point2D.Float, and Point? Check Java API to see what methods are defined in Point2D.

#### *Section 49.4*

49.7 What are the relationships among Rectangle2D, Rectangle2D.Double, Rectangle2D.Float, and Rectangle?

49.8 You can draw basic shapes such as lines, rectangles, ellipses, and arcs using the drawing/filling methods in the Graphics class or create a Shape object and render them using the draw(Shape) or fill(Shape). What are the advantages of using the latter?

#### *Section 49.5*

49.9 Suppose a rectangle is created using new Rectangle2D.Double(2, 3, 4, 5). Where is it displayed after applying g2d.translate(10, 10) and g2d.draw(rectangle)?

49.10 Suppose a rectangle is created using new Rectangle2D.Double(2, 3, 4, 5). Where is it displayed after applying g2d.rotate(Math.PI / 5) and g2d.draw(rectangle)?

49.11 Suppose a rectangle is created using new Rectangle2D.Double(2, 3, 4, 5). Where is it displayed after applying g2d.scale(10, 10) and g2d.draw(rectangle)?

#### *Sections 49.6-49.7*

49.12 How do you create a Stroke and set a stroke in Graphics2D?

49.13 How do you create a Paint and set a paint in Graphics2D?

49.14 What is a gradient paint? How do you create a GradientPaint?

49.15 What is a texture paint? How do you create a TexturePaint?

#### *Sections 49.8-49.10*

49.16 How do you create a QuadCurve2D? How do you create a CubicCurve2D?

49.17 Describe the methods in Path2D?

49.18 What is the winding rule? What is WIND\_EVEN\_ODD? What is WIND\_NON\_ZERO?

49.19 How do you create an Area from a shape? Describe the add, subtract, intersect, and exclusiveOr methods in the Area class.

### **Programming Exercises**

#### *Section 49.4*

49.1\*

(*Inside a rectangle?*) Write a program that displays a rectangle with upper-left corner point at (20, 20), width 100, and height 100. Whenever you move the mouse, display a message indicating whether the mouse point is inside the rectangle, as shown in Figure 49.27a-b.



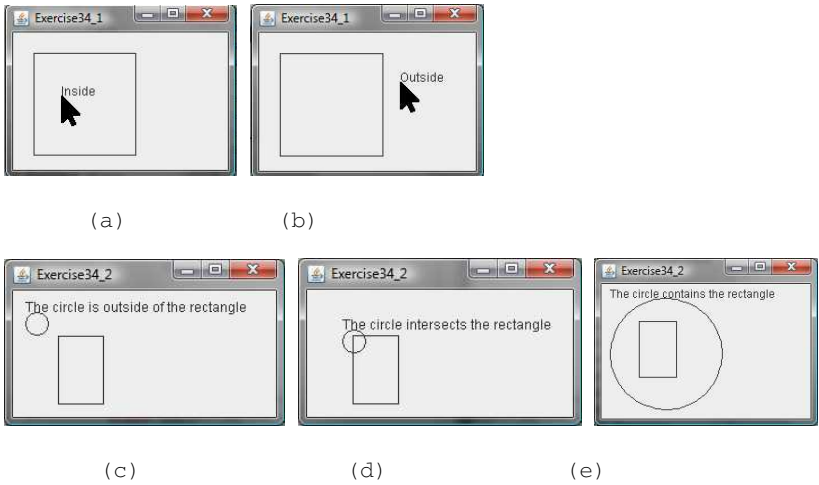


Figure 49.27

(a-b) Exercise 49.1 detects whether a point is inside a rectangle. (c-e) Exercise 49.2 detects whether a circle contains, intersects, or is outside a rectangle.

49.2\*

(Contains, intersects, or outside?) Write a program that displays a rectangle with upper-left corner point at (40, 40), width 40, and height 60. Display a circle. The circle's upper-left corner of the bounding rectangle is at the mouse point. pressing the up/down arrow key increases/decreases the circle radius by 5 pixels by. Display a message at the mouse point to indicate whether the circle contains, intersects, or is outside of the rectangle, as shown in Figure 49.27c-e.

49.3\*

(Translation) Write a program that displays a rectangle with upper-left corner point at (40, 40), width 50, and height 40. Enter the values in the text fields x and y and press the Translate button to translate the rectangle to a new location, as shown in Figure 49.28a.

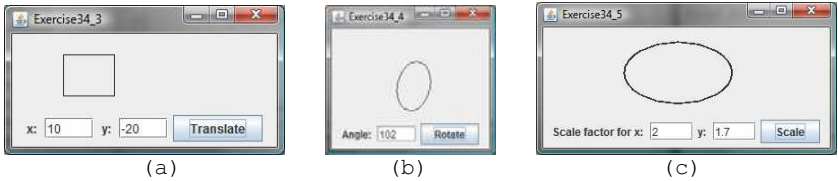


Figure 49.28

(a) Exercise 49.3 translates coordinates. (b) Exercise 49.4 rotates coordinates. (c) Exercise 49.5 scales coordinates.

49.4\*

(Rotation) Write a program that displays an ellipse. The center of the ellipse is at (0, 0) with width 60 and height 40. Use the translate method to move the origin to (100, 70). Enter the value in the text

field Angle and press the *Rotate* button to rotate the ellipse to a new location, as shown in Figure 49.28b.

49.5\*

(*Scale graphics*) Write a program that displays an ellipse. The center of the ellipse is at  $(0, 0)$  with width 60 and height 40. Use the translate method to move the origin to  $(150, 50)$ . Enter the scaling factors in the text fields and press the *Scale* button to scale the ellipse, as shown in Figure 49.28c.

49.6\*

(*Vertical strings*) Write a program that displays three strings vertically, as shown in Figure 49.29a.

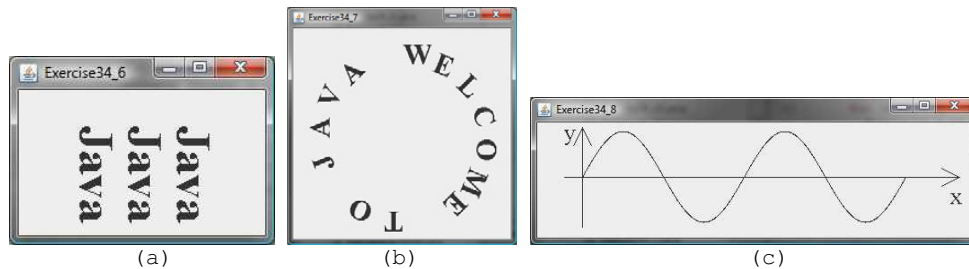


Figure 49.29

(a) Exercise 49.6 displays strings vertically. (b) Exercise 49.7 displays characters around the circle. (c) Exercise 49.8 displays a sine function.

49.7\*

(*Characters around circle*) Write a program that displays a string around the circle, as shown in Figure 49.29b.

49.8\*

(*Plot the sine function*) Write a program that plots the sine function, as shown in Figure 49.29c.

49.9\*

(*Plot the log function*) Write a program that plots the log function, as shown in Figure 49.30a.

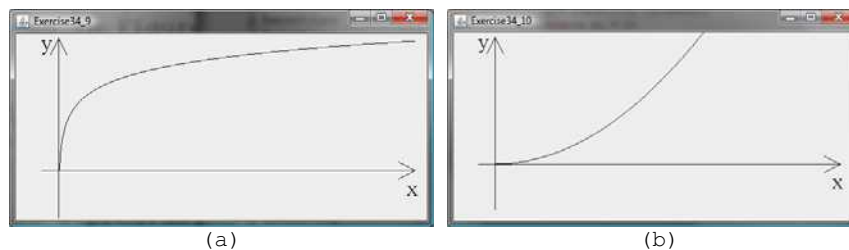


Figure 49.30

(a) Exercise 49.9 displays the log function. (b) Exercise 49.10 displays the  $n^2$  function.

49.10\*

(*Plot the  $n^2$  function*) Write a program that plots the  $n^2$  function, as shown in Figure 49.30b.

49.11\*

(Plot the log,  $n$ ,  $n \log n$ , and  $n^2$  functions) Write a program that plots the log,  $n$ ,  $n \log n$ , and  $n^2$  functions, as shown in Figure 49.31a.

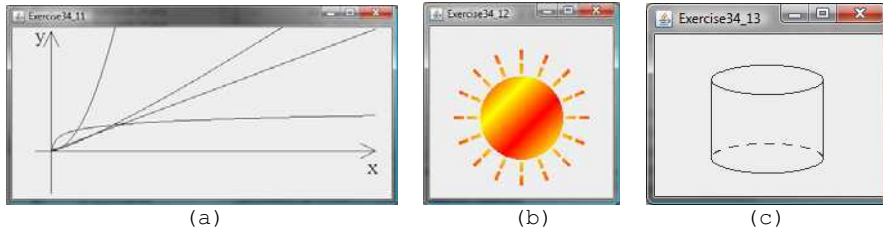


Figure 49.31

(a) Exercise 49.11 displays several functions. (b) Exercise 49.12 displays the sunshine. (c) Exercise 49.13 displays a cylinder.

49.12\*

(Sunshine) Write a program that displays a circle filled with a gradient color to animate a sun and display light rays coming out from the sun using dashed lines, as shown in Figure 49.31b.

49.13\*

(Display a cylinder) Write a program that displays a cylinder, as shown in Figure 49.31c. Use dashed strokes to draw the dashed arc.

49.14\*

(Filled cylinder) Write a program that displays a filled cylinder, as shown in Figure 49.32a.

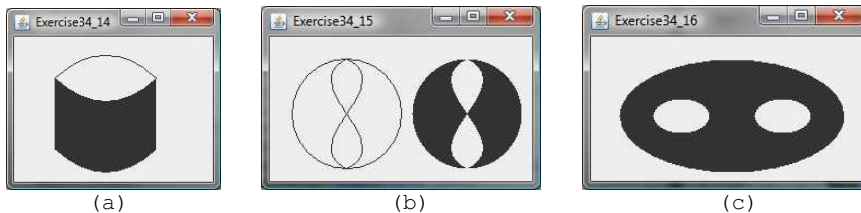


Figure 49.32

(a) Exercise 49.14 displays a filled cylinder. (b) Exercise 49.15 displays symmetric difference of two areas. (c) Exercise 49.16 displays two eyes.

49.15\*

(Area geometry) Write a program that creates two areas: a circle and a path consisting of two cubic curves. Draw the areas and fill the symmetric difference of the areas, as shown in Figure 49.32(b).

49.16\*

(Eyes) Write a program that displays two eyes in an oval, as shown in Figure 49.32c.

49.17\*\*

(Geometry: strategic point of a polygon) Revise Exercise 14.33 to enable the user to drag and move the vertices and the program dynamically redisplay the polygon and its strategic point. Write a program as an applet and assume the five points of the polygon are initially located at  $(25, 20)$ ,  $(170, 25)$ ,  $(200, 100)$ ,  $(100, 110)$ , and  $(50, 80)$ .

49.18\*

(*Scale and rotate graphics*) Write an applet that enables the user to scale and rotate the STOP sign, as shown in Figure 49.33. The user can press the CTRL and +/- key to increase/decrease the size and press the RIGHT/LEFT arrow key to rotate left or right.



Figure 49.33

*The applet can scale and rotate the painting.*

*\*\*\*This is a bonus Web chapter*

## **CHAPTER 50**

### **Testing Using JUnit**

Objectives

- To know what JUnit is and how JUnit works (§50.2).
- To create and run a JUnit test class from the command window (§50.2).
- To create and run a JUnit test class from NetBeans (§50.3).
- To create and run a JUnit test class from Eclipse (§50.4).

## 50.1 Introduction

At the very beginning of this book in Section 2.16, we introduced software development process that includes requirements specification, analysis, design, implementation, testing, deployment, and maintenance. Testing is an important part of this process. This chapter introduces how to test Java classes using JUnit.

## 50.2 JUnit Basics

**<key term>JUnit**

**<key term>test runner**

**<key term>test class**

JUnit is the de facto framework for testing Java programs. JUnit is a third-party open source library packed in a jar file. The jar file contains a tool called *test runner*, which is used to run test programs. Suppose you have a class named A. To test this class, you write a test class named ATest. This test class, called a *test class*, contains the methods you write for testing class A. The test runner executes ATest to generate a test report, as shown in Figure 50.1.

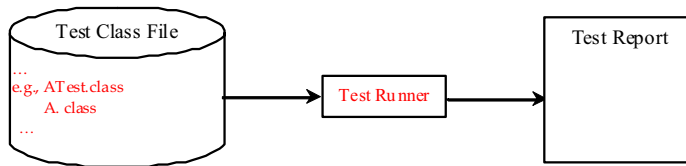


Figure 50.1

*JUnit test runner executes the test class to generate a test report.*

You will see how JUnit works from an example. To create the example, first you need to download JUnit from <http://sourceforge.net/projects/junit/files/>. At present, the latest version is junit-4.10.jar. Download this file to c:\book\lib and add it to the classpath environment variable as follows:

```
set classpath=.;%classpath%;c:\book\lib\junit-4.10.jar
```

To test if this environment variable is set correctly, open a new command window, and type the following command:

```
java org.junit.runner.JUnitCore
```

You should see the message displayed as shown in Figure 50.2.



Figure 50.2

The JUnit test runner displays the JUnit version.

To use JUnit, create a test class. By convention, if the class to be tested is named A, the test class should be named ATest. A simple template of a test class may look like this:

```
package mytest;

import org.junit.*;
import static org.junit.Assert.*;

public class ATest {
 @Test
 public void m1() {
 // Write a test method
 }

 @Test
 public void m2() {
 // Write another test method
 }

 @Before
 public void setUp() throws Exception {
 // Common objects used by test methods may be set up here
 }
}
```

To run the test from the console, use the following command:

```
java org.junit.runner.JUnitCore mytest.ATest
```

**<key term>JUnitCore**

When this command is executed, JUnitCore controls the execution of ATest. It first executes the setUp() method to set up the common objects used for the test, and then executes test methods m1 and m2 in this order. You may define multiple test methods if desirable.

The following methods can be used to implement a test method:

`assertTrue(booleanExpression)`

The method reports success if the `booleanExpression` evaluates true.

`assertEquals(Object, Object)`

The method reports success if the two objects are the same using the equals method.

`assertNull(Object)`

The method reports success if the object reference passed is null.

`fail(String)`

The method causes the test to fail and prints out the string.

Listing 50.1 is an example of a test class for testing java.util.ArrayList.

**Listing 50.1 ArrayListTest.java**

**<Side Remark line 7: test class>**

<Side Remark line 15: test method>  
<Side Remark line 17: assertion>  
<Side Remark line 20: assertion>  
<Side Remark line 24: test method>  
<Side Remark line 26: assertion>  
<Side Remark line 32: assertion>

```
package mytest;

import org.junit.*;
import static org.junit.Assert.*;
import java.util.*;

public class ArrayListTest {
 private ArrayList<String> list = new ArrayList<String>();

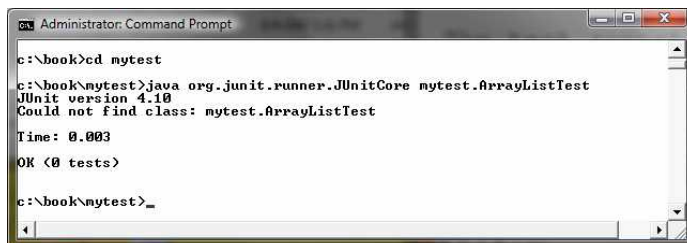
 @Before
 public void setUp() throws Exception {
 }

 @Test
 public void testInsertion() {
 list.add("Beijing");
 assertEquals("Beijing", list.get(0));
 list.add("Shanghai");
 list.add("Hongkong");
 assertEquals("Hongkong", list.get(list.size() - 1));
 }

 @Test
 public void testDeletion() {
 list.clear();
 assertTrue(list.isEmpty());

 list.add("A");
 list.add("B");
 list.add("C");
 list.remove("B");
 assertEquals(2, list.size());
 }
}
```

A test run of the program is shown in Figure 50.3. Note that you have to first compile `ArrayListTest.java`. The `ArrayListTest` class is placed in the `mytest` package. So you should place `ArrayListTest.java` in the directory named `mytest`.



```
Administrator: Command Prompt
c:\book>cd mytest
c:\book\mytest>java org.junit.runner.JUnit4Core mytest.ArrayListTest
JUnit version 4.10
Could not find class: mytest.ArrayListTest
Time: 0.003
OK (0 tests)
c:\book\mytest>_
```



Figure 50.3

The test report is displayed from running `ArrayListTest`.

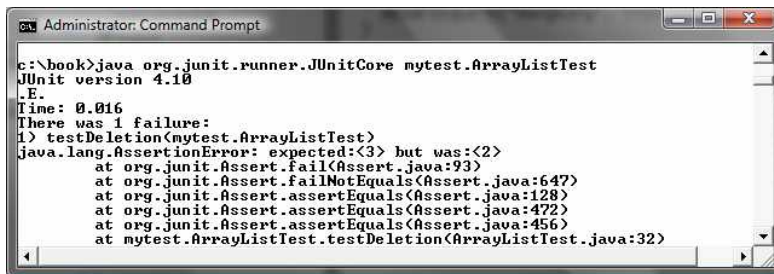
No errors are reported in this JUnit run. If you mistakenly change

```
assertEquals(2, list.size());
```

in line 32 to

```
assertEquals(3, list.size());
```

Run `ArrayListTest` now. You will see an error reported as shown in Figure 50.4.



```
Administrator: Command Prompt
c:\book>java org.junit.runner.JUnitCore mytest.ArrayListTest
JUnit version 4.10
.E
Time: 0.016
There was 1 failure:
1) testDeletion(mytest.ArrayListTest)
java.lang.AssertionError: expected:<3> but was:<2>
 at org.junit.Assert.fail(Assert.java:93)
 at org.junit.Assert.failNotEquals(Assert.java:647)
 at org.junit.Assert.assertEquals(Assert.java:128)
 at org.junit.Assert.assertEquals(Assert.java:472)
 at org.junit.Assert.assertEquals(Assert.java:456)
 at mytest.ArrayListTest.testDeletion(ArrayListTest.java:32)
```

Figure 50.4

The test report reports an error.

You can define any number of test methods. In this example, two test methods `testInsertion` and `testDeletion` are defined. JUnit executes `testInsertion` and `testDeletion` in this order.

NOTE: The test class must be placed in a named package such as `mytest` in this example. The JUnit will not work if the test class is placed a default package.

Listing 50.2 gives a test class for testing the `Loan` class in Listing 10.2. For convenience, we create `Loan.java` in the same directory with `LoanTest.java`. The `Loan` class is shown in Listing 50.3.

#### Listing 50.2 `LoanTest.java`

*<Side Remark line 6: test class>*  
*<Side Remark line 12: test method>*  
*<Side Remark line 19: assertion>*  
*<Side Remark line 22: assertion>*  
*<Side Remark line 28: compute monthly payment>*  
*<Side Remark line 37: compute total payment>*

```
package mytest;

import org.junit.*;
import static org.junit.Assert.*;

public class LoanTest {
```

```

@Before
public void setUp() throws Exception {
}

@Test
public void testPaymentMethods() {
 double annualInterestRate = 2.5;
 int numberOfYears = 5;
 double loanAmount = 1000;
 Loan loan = new Loan(annualInterestRate, numberOfYears,
 loanAmount);

 assertTrue(loan.getMonthlyPayment() ==
 getMonthlyPayment(annualInterestRate, numberOfYears,
 loanAmount));
 assertTrue(loan.getTotalPayment() ==
 getTotalPayment(annualInterestRate, numberOfYears,
 loanAmount));
}

/** Find monthly payment */
private double getMonthlyPayment(double annualInterestRate,
 int numberOfYears, double loanAmount) {
 double monthlyInterestRate = annualInterestRate / 1200;
 double monthlyPayment = loanAmount * monthlyInterestRate / (1 -
 (1 / Math.pow(1 + monthlyInterestRate, numberOfYears * 12)));
 return monthlyPayment;
}

/** Find total payment */
public double getTotalPayment(double annualInterestRate,
 int numberOfYears, double loanAmount) {
 return getMonthlyPayment(annualInterestRate, numberOfYears,
 loanAmount) * numberOfYears * 12;
}
}

```

### Listing 50.3 Loan.java

*<Side Remark line 1: mytest package>*  
*<Side Remark line 3: the Loan class>*  
*<Side Remark line 56: [getMonthlyPayment](#)>*  
*<Side Remark line 64: [getTotalPayment](#)>*

```

package mytest;

public class Loan {
 private double annualInterestRate;
 private int numberOfYears;
 private double loanAmount;
 private java.util.Date loanDate;

 /** Default constructor */
 public Loan() {
 this(2.5, 1, 1000);
 }
}

```

```

 /** Construct a loan with specified annual interest rate,
 number of years, and loan amount
 */
 public Loan(double annualInterestRate, int numberOfYears,
 double loanAmount) {
 this.annualInterestRate = annualInterestRate;
 this.numberOfYears = numberOfYears;
 this.loanAmount = loanAmount;
 loanDate = new java.util.Date();
 }

 /** Return annualInterestRate */
 public double getAnnualInterestRate() {
 return annualInterestRate;
 }

 /** Set a new annualInterestRate */
 public void setAnnualInterestRate(double annualInterestRate) {
 this.annualInterestRate = annualInterestRate;
 }

 /** Return numberOfYears */
 public int getNumberOfYears() {
 return numberOfYears;
 }

 /** Set a new numberOfYears */
 public void setNumberOfYears(int numberOfYears) {
 this.numberOfYears = numberOfYears;
 }

 /** Return loanAmount */
 public double getLoanAmount() {
 return loanAmount;
 }

 /** Set a new loanAmount */
 public void setLoanAmount(double loanAmount) {
 this.loanAmount = loanAmount;
 }

 /** Find monthly payment */
 public double getMonthlyPayment() {
 double monthlyInterestRate = annualInterestRate / 1200;
 double monthlyPayment = loanAmount * monthlyInterestRate / (1 -
 (1 / Math.pow(1 + monthlyInterestRate, numberOfYears * 12)));
 return monthlyPayment;
 }

 /** Find total payment */
 public double getTotalPayment() {
 double totalPayment = getMonthlyPayment() * numberOfYears * 12;
 return totalPayment;
 }

```

```

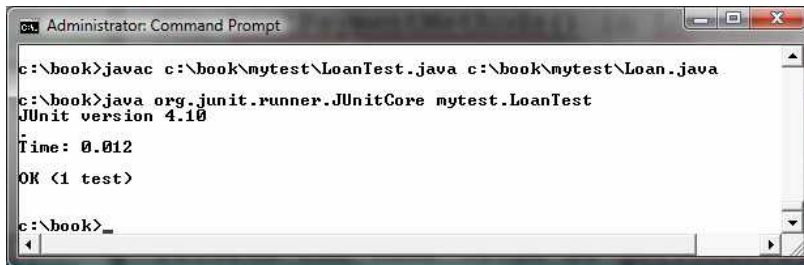
 /** Return loan date */
 public java.util.Date getLoanDate() {
 return loanDate;
 }
}

```

The `testPaymentMethods()` in `LoanTest` creates an instance of `Loan` (line 16-17) and tests whether `loan.getMonthlyPayment()` returns the same value as `getMonthlyPayment(annualInterestRate, numberOfYears, loanAmount)`. The latter method is defined in the `LoanTest` class (lines 28-34).

The `testPaymentMethods()` also tests whether `loan.getTotalPayment()` returns the same value as `getTotalPayment(annualInterestRate, numberOfYears, loanAmount)`. The latter method is defined in the `LoanTest` class (lines 37-41).

A sample run of the program is shown in Figure 50.5.



```

Administrator: Command Prompt
c:\book>javac c:\book\mytest\LoanTest.java c:\book\mytest\Loan.java
c:\book>java org.junit.runner.JUnitCore mytest.LoanTest
JUnit version 4.10
Time: 0.012
OK (1 test)
c:\book>_

```

Figure 50.5

The JUnit test runner executes `LoanTest` and reports no errors.

### 50.3 Using JUnit from NetBeans

An IDE like NetBeans and Eclipse can greatly simplify the process for creating and running test classes. This section introduces using JUnit from NetBeans and the next section introduces using JUnit from Eclipse.

If you not familiar with NetBeans, see Supplement II.B. Assume you have installed NetBeans 7.0. Create a project named `chapter50` as follows:

Step 1: Choose *File, New Project* to display the New Project dialog box.

Step 2: Choose Java in the Categories section and Java Application in the Projects section. Click *Next* to display the New Java Application dialog box.

Step 3: Enter `chapter50` as the Project Name and `c:\book` as Project Location. Click *Finish* to create the project as shown in Figure 50.6.

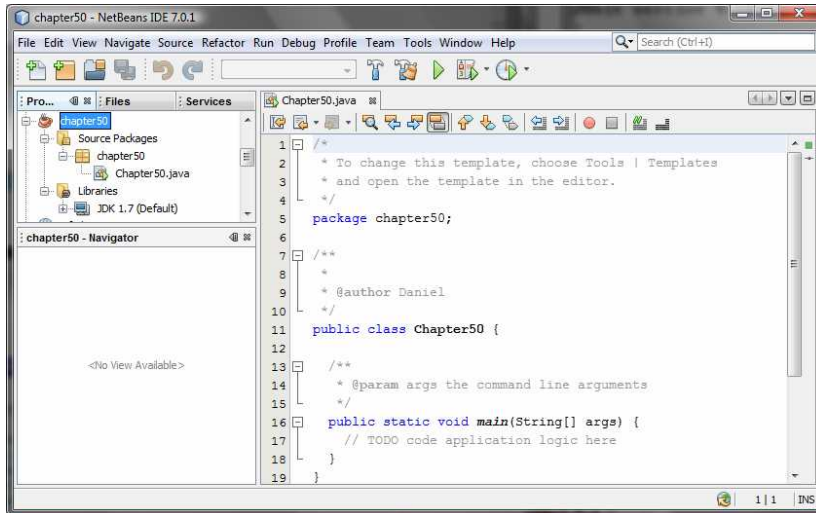


Figure 50.6

A new project named chapter50 is created.

To demonstrate how to create a test class, we first create class to be tested. Let the class be Loan from Listing 10.2. Here are the steps to create the Loan class under chapter50.

- Step 1: Right-click the project node chapter50 and choose *New, Java Class* to display the New Java Class dialog box.
- Step 2: Enter Loan as Class Name and chapter50 in the Package field and click *Finish* to create the class.
- Step 3: Copy the code in Listing 10.2 to the Loan class and make sure the first line is package chapter50, as shown in Figure 50.7.

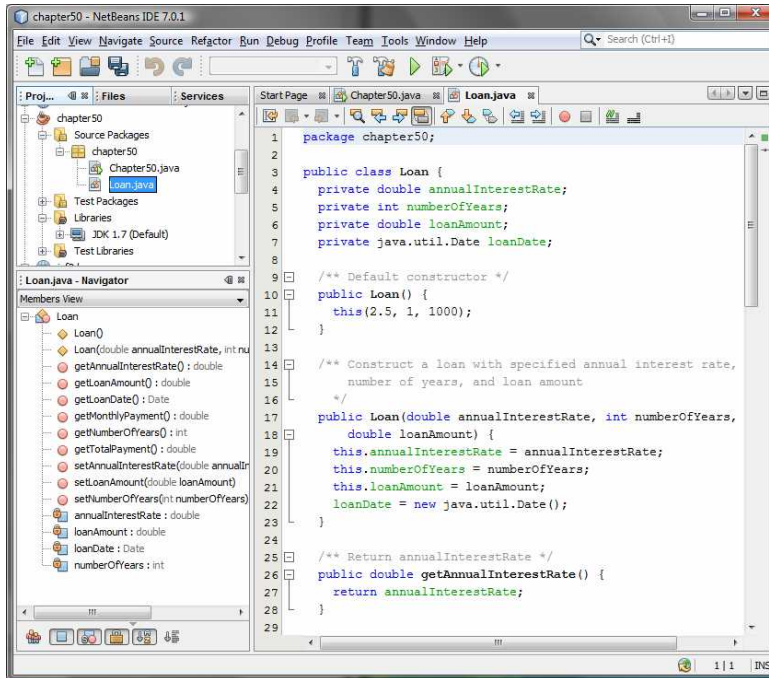


Figure 50.7

The Loan class is created.

Now you can create a test class to test the Loan class as follows:

Step 1: Right-click Loan.java in the project to display a context menu and choose *Tools, Create JUnit Test* to display the Select JUnit version dialog box, as shown in Figure 50.8.

Step 2: Choose JUnit 4.x. You will see the Create Tests dialog box displayed as shown in Figure 50.9. Click *OK* to generate a Test class named LoanTest as shown in Figure 50.10. Note that LoanTest.java is placed under the Test Packages node in the project.

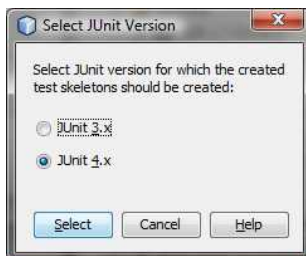


Figure 50.8

You should select JUnit 4.x framework to create test classes.

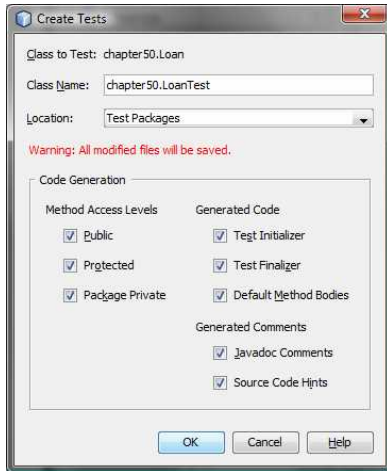


Figure 50.9

The Create Tests dialog box creates a Test class.

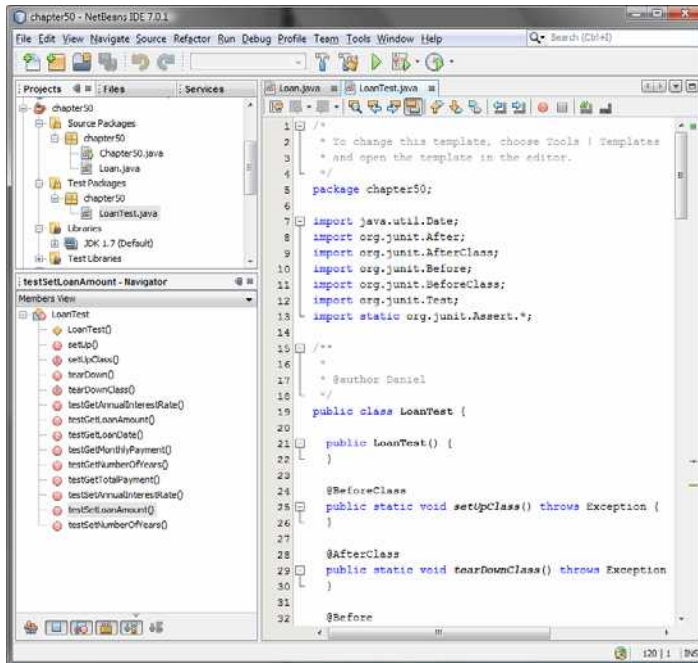


Figure 50.10

The LoanTest class is automatically generated.

You can now modify LoanTest by copying the code from Listing 50.2. Run LoanTest.java. You will see the test report as shown in Figure 50.11.

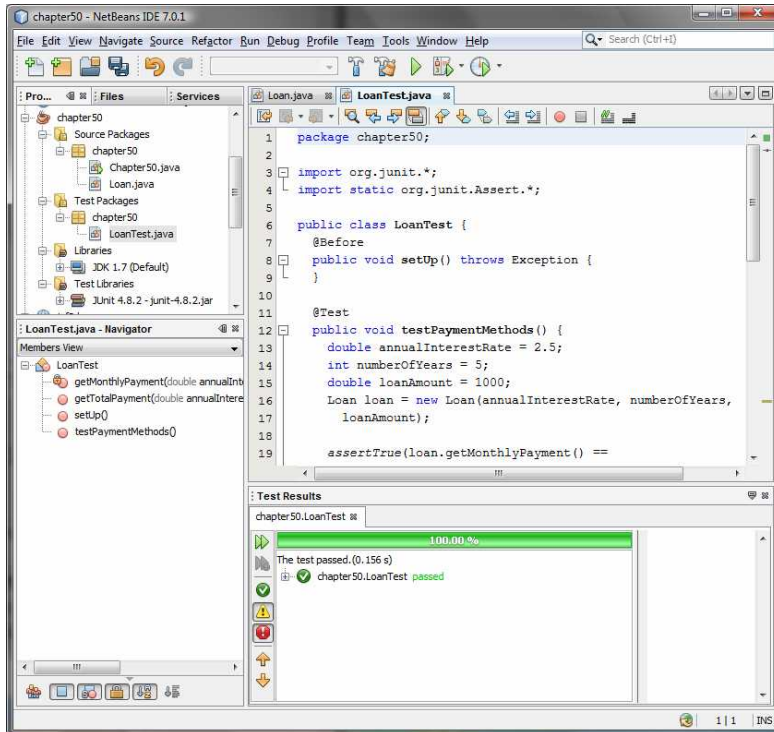


Figure 50.11

The test report is displayed after the `LoanTest` class is executed.

#### 50.4 Using JUnit from Eclipse

This section introduces using JUnit from Eclipse. If you are not familiar with Eclipse, see Supplement II.D. Assume you have installed Eclipse 3.7. Create a project named `chapter50` as follows:

Step 1: Choose *File, New Java Project* to display the New Java Project dialog box, as shown in Figure 50.12.

Step 2: Enter `chapter50` in the project name field and click *Finish* to create the project.



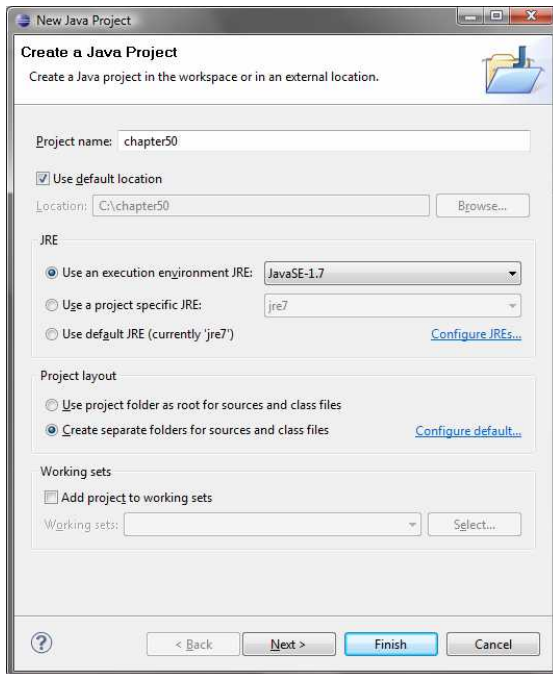


Figure 50.12

The New Java Project dialog creates a new project.

To demonstrate how to create a test class, we first create class to be tested. Let the class be Loan from Listing 10.2. Here are the steps to create the Loan class under chapter50.

Step 1: Right-click the project node chapter50 and choose *New, Class* to display the New Java Class dialog box, as shown in Figure 50.13.

Step 2: Enter mytest in the Package field and click *Finish* to create the class.

Step 3: Copy the code in Listing 10.2 to the Loan class and make sure the first line is package mytest, as shown in Figure 50.14.



Figure 50.13

The New Java Class dialog creates a new Java class.

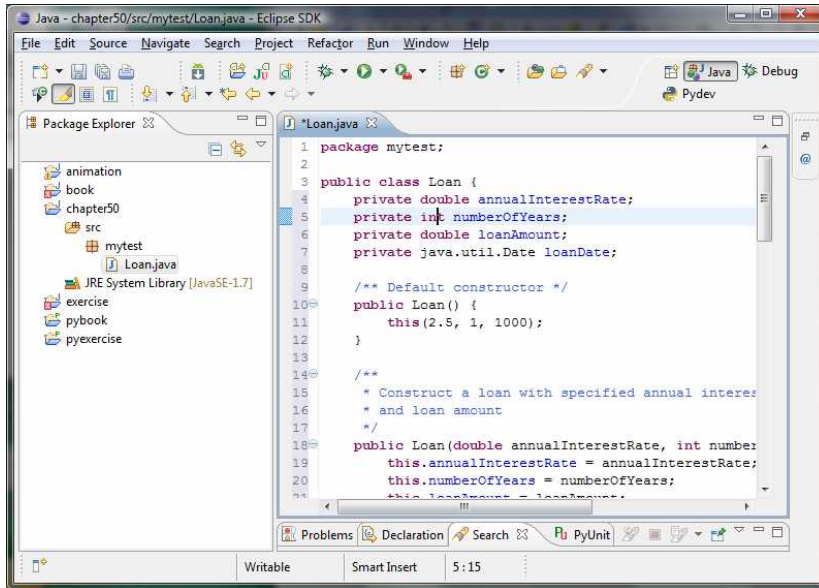


Figure 50.14

The Loan class is created.

Now you can create a test class to test the Loan class as follows:

Step 1: Right-click Loan.java in the project to display a context menu and choose *New, JUnit Test Case* to display the New JUnit Test Case dialog box, as shown in Figure 50.15.

Step 2: Click *Finish*. You will see a dialog prompting you to add JUnit 4 to the project build path. Click *OK* to add it. Now a test class named LoanTest is created as shown in Figure 50.16.

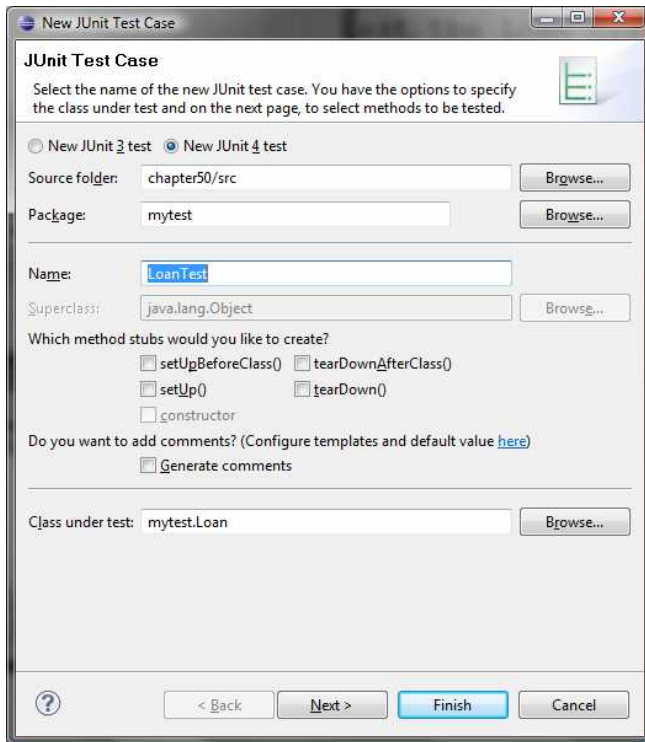


Figure 50.15

The New JUnit Test Case dialog box creates a Test class.

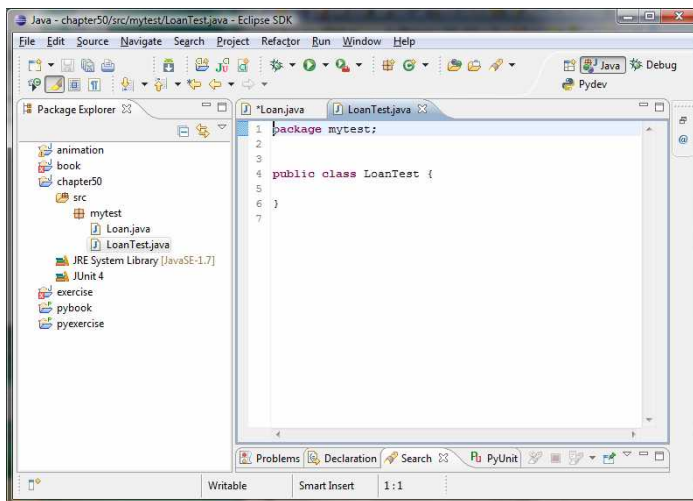


Figure 50.16

The LoanTest class is automatically generated.

You can now modify LoanTest by copying the code from Listing 50.2. Run LoanTest.java. You will see the test report as shown in Figure 50.17.

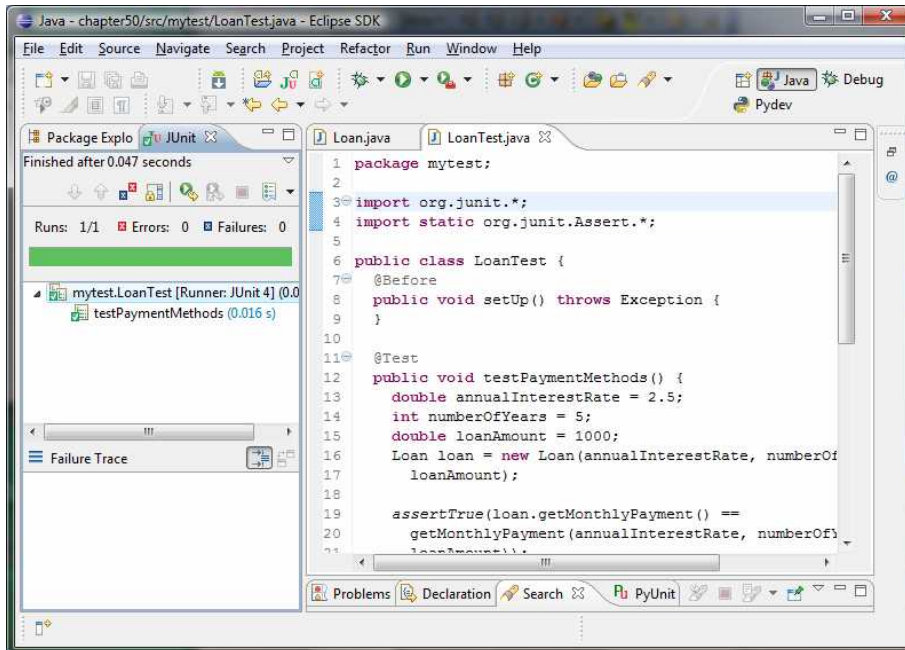


Figure 50.17

The test report is displayed after the LoanTest class is executed.

### Key Terms

- JUnit
- JUnitCore
- test class
- test runner

### Chapter Summary

1. JUnit is an open source framework for testing Java programs.
2. To test a Java class, you create a test class for the class to be tested and use JUnit's test runner to execute the test class to generate a test report.
3. You can create and run a test class from the command window or use a tool such as NetBeans and Eclipse.

### Test Questions

Do the test questions for this chapter online at [www.cs.armstrong.edu/liang/intro9e/test.html](http://www.cs.armstrong.edu/liang/intro9e/test.html).

### Review Questions

- 50.1 What is JUnit?
- 50.2 What is a JUnit test runner?

50.3 What is a test class? How do you create a test class?

50.4 How do you use the assertTrue method?

50.5 How do you use the assertEquals method?

### **Programming Exercises**

50.1

Write a test class to test the methods length, charAt, substring, and indexOf in the java.lang.String class.

50.2

Write a test class to test the methods add, remove, addAll, removeAll, size, isEmpty, and contains in the java.util.HashSet class.

50.3

Write a test class to test the method isPrime in Listing 5.7 PrimeNumberMethod.java.

50.4

Write a test class to test the methods getBMI and getStatus in the BMI class in Listing 10.4.